

International Collaboration Activities in Different Geologic Disposal Environments

Fuel Cycle Research & Development

*Prepared for
U.S. Department of Energy*

Used Fuel Disposition

*Jens Birkholzer
Lawrence Berkeley National Laboratory*

September 2016

*With Contributions from Boris Faybishenko,
Liange Zheng, and Jonny Rutqvist (LBNL), Paul
Reimus and Hari Viswanathan (LANL), Carlos
Jove-Colon and Yifeng Wang (SNL), Mavrik
Zavarin (LLNL)*



FCRD-UFD-2016-000077

LBNL-1006321

DISCLAIMER

This document was prepared as an account of work sponsored by the United States Government. While this document is believed to contain correct information, neither the United States Government nor any agency thereof, nor the Regents of the University of California, nor any of their employees, makes any warranty, express or implied, or assumes any legal responsibility for the accuracy, completeness, or usefulness of any information, apparatus, product, or process disclosed, or represents that its use would not infringe privately owned rights. Reference herein to any specific commercial product, process, or service by its trade name, trademark, manufacturer, or otherwise, does not necessarily constitute or imply its endorsement, recommendation, or favoring by the United States Government or any agency thereof, or the Regents of the University of California. The views and opinions of authors expressed herein do not necessarily state or reflect those of the United States Government or any agency thereof or the Regents of the University of California.

APPENDIX E

FCT DOCUMENT COVER SHEET ¹

Name/Title of Deliverable/Milestone/Revision No.	International Collaboration Activities in Different Geologic Disposal Environments
Work Package Title and Number	DR International Disposal R&D – LBNL FT-16LB08030501
Work Package WBS Number	1.02.08.03.05
Responsible Work Package Manager	Jens Birkholzer (signature on file)

(Name/Signature)

Date Submitted 09/23/2016

Quality Rigor Level for Deliverable/Milestone ²	<input checked="" type="checkbox"/> QRL-3	<input type="checkbox"/> QRL-2	<input type="checkbox"/> QRL-1 <input type="checkbox"/> Nuclear Data	<input type="checkbox"/> Lab/Participant QA Program (no additional FCT QA requirements)
--	---	--------------------------------	---	---

This deliverable was prepared in accordance with Lawrence Berkeley National Laboratory
(Participant/National Laboratory Name)

QA program which meets the requirements of
 DOE Order 414.1 NQA-1-2000 Other

This Deliverable was subjected to:

Technical Review Peer Review

Technical Review (TR)

Peer Review (PR)

Review Documentation Provided

Review Documentation Provided

Signed TR Report or,
 Signed TR Concurrence Sheet or,
 Signature of TR Reviewer(s) below

Signed PR Report or,
 Signed PR Concurrence Sheet or,
 Signature of PR Reviewer(s) below

Name and Signature of Reviewers

Boris Faybishenko (signature on file)

Liange Zheng (signature on file)

NOTE 1: Appendix E should be filled out and submitted with the deliverable. Or, if the PICS:NE system permits, completely enter all applicable information in the PICS:NE Deliverable Form. The requirement is to ensure that all applicable information is entered either in the PICS:NE system or by using the FCT Document Cover Sheet.

NOTE 2: In some cases there may be a milestone where an item is being fabricated, maintenance is being performed on a facility, or a document is being issued through a formal document control process where it specifically calls out a formal review of the document. In these cases, documentation (e.g., inspection report, maintenance request, work planning package documentation or the documented review of the issued document through the document control process) of the completion of the activity along with the Document Cover Sheet is sufficient to demonstrate achieving the milestone. If QRL 1, 2, or 3 is not assigned, then the Lab/Participant QA Program (no additional FCT QA requirements) box must be checked, and the work is understood to be performed, and any deliverable developed, in conformance with the respective National Laboratory/Participant, DOE- or NNSA-approved QA Program.

This page is intentionally blank.

EXECUTIVE SUMMARY

Background and Main Objective

This report describes the status of international collaboration regarding geologic disposal research in the Used Fuel Disposition (UFD) Campaign. Since 2012, in an effort coordinated by Lawrence Berkeley National Laboratory, UFD has advanced active collaboration with several international geologic disposal programs in Europe and Asia. Such collaboration allows the UFD Campaign to benefit from a deep knowledge base in regards to alternative repository environments developed over decades, and to utilize international investments in research facilities (such as underground research laboratory test and modeling), saving millions of R&D dollars that have been and are being provided by other countries. To date, UFD's International Disposal R&D Program has established formal collaboration agreements with several international initiatives and various international partners, and national lab scientists associated with UFD have conducted specific collaborative R&D activities that align well with its R&D priorities. Guiding principles for selection of collaboration options and activities are as follows:

- Focus on activities that complement ongoing disposal R&D within UFD (e.g., the science and engineering tools developed in UFD are tested in comparison with international experiments).
- Select collaborative R&D activities based on technical merit, relevance to safety case, and cost/benefit, and strive for balance in terms of host rock focus and repository design.
- Emphasize collaboration that provides access to and/or allows participation in field experiments conducted in operating underground research laboratories not currently available in the U.S. (i.e., clay, crystalline, salt).
- Focus on collaboration opportunities for active R&D participation (i.e., U.S. researcher's work closely together with international scientists on specific R&D projects relevant to both sides).

Key Issues Tackled in Current and Planned Portfolios

The current work conducted within international activities centers on the following key research questions:

- **Near-Field Perturbation:** How important is the near-field damage to a host rock (such as clay and salt) due to initial mechanical and thermal perturbation, and how effective is healing and sealing of the damage zone in the long term? How reliable are existing constitutive models for the deformation of elastoplastic and plastic geomaterials as affected by temperature and water-content changes?
- **Engineered Barrier Integrity:** What is the long-term stability and retention capability of backfills and seals? Can bentonite mixtures be developed that allow for gas-pressure release while maintaining sealing properties for water? Can bentonite be eroded when in contact with water from flowing fractures? How relevant are interactions between engineered and natural barrier materials, such as metal-bentonite-cement interactions?
- **Radionuclide Transport:** Can the radionuclide transport in fractured rock be predicted with confidence? What is the potential for enhanced transport with colloids? How can the diffusive transport processes in nanopore materials such as compacted clays and bentonites best be described? What is the effect of high temperature on the swelling and sorption characteristics of clays (i.e., considering the heat load from dual-purpose canisters)?
- **Demonstration of Integrated System Behavior:** Can the behavior of an entire repository system, including all engineered and natural barriers and their interaction, be measured and demonstrated? Are the planned construction/emplacement methods feasible?

International Cooperative Initiatives

Since 2012, UFD has joined several multinational cooperation initiatives as a formal partner, and has established a balanced portfolio of selected R&D projects collaborating with international peers. These projects cover a range of relevant R&D fields like near-field perturbation, engineered barrier integrity, radionuclide (RN) transport, and integrated system behavior.

Mont Terri Project

The Mont Terri Project is an international research partnership for the characterization and performance assessment of a clay/shale formation (currently 16 partners). The partnership essentially provides open access to an existing underground research laboratory (URL) in Switzerland, the Mont Terri URL. Partner organizations can conduct experiments in the URL, can participate in experiments conducted by others, and have access to all project results from past and ongoing efforts. In the current phase, the Mont Terri Project comprises about 40 separate experiments that are relevant to all relevant phases in the lifetime of a repository. The annual budget for the *in situ* work amounts to several million U.S. dollars, complemented by the interpretation, analyses, and modeling work conducted by the partners. DOE joined the Mont Terri Project as a formal partner in July 2012. UFD researchers have engaged in several projects ranging from large-scale heater tests to damage zone, diffusion and fault slip experiments.

DECOVALEX Project

The DECOVALEX Project is an international research collaboration and model comparison activity for coupled processes simulations in geologic repository systems (currently 12 project partners). The project develops modeling test cases that involve experimental data sets from international underground research facilities. Typically, these experimental test cases are proposed by one of the project partners, and are then collectively studied and modeled by all DECOVALEX participants. These URLs, and the activities conducted there, constitute multi-million dollar investments now available to UFD researchers. With the start of a new project phase, DOE joined DECOVALEX in January 2012 as a formal partner. This project phase, which involved test cases from four international underground research laboratories (URLs) in France (Tournemire), Japan (Horonobe), Switzerland (Mont Terri), and the Czech Republic (Bedrichov Tunnel), ended in December 2015. Modeling cases with UFD involvement included, for example, the engineered-barrier heater tests at Mont Terri and Horonobe, and the use of environmental tracers for estimating fracture properties related to the Bedrichov Tunnel. A new DECOVALEX Project phase was initiated in early 2016, referred to as DECOVALEX 2019, and DOE continues to participate in several new tasks.

Colloid Formation and Migration (CFM) Project

The CFM Project is an international research project for the investigation of colloid formation, bentonite erosion, colloid migration, and colloid-associated radionuclide transport. This collaborative project (currently nine partners) is one of several experimental R&D projects associated with the Grimsel Test Site (GTS) in the Swiss Alps, a URL situated in sparsely fractured crystalline host rock and one of few facilities underground that permits radionuclide studies. The CFM project conducts radionuclide migration experiments in a fracture shear zone complemented by laboratory and modeling studies. DOE joined the CFM Project in August 2012 but decided in 2015 to end its official membership. However, UFD researchers continue to collaborate with CFM researchers, e.g., interpreting field measurements conducted at GTS using semi-analytical and numerical methods, and supporting the field interpretation with laboratory experiments on colloidal transport and sorption.

FEBEX Dismantling Project

The Full-scale Engineered Barriers EXperiment (FEBEX) experiment at GTS consists of an *in situ* full-scale heater test conducted in a crystalline host rock with bentonite backfill (currently 10 partners). Heating started in 1997, and since then a constant temperature of 100°C has been maintained, while the bentonite buffer has been slowly hydrating in a natural way. The heating phase of the experiment ended in spring 2015 after 18 years of operation. A new international collaboration project, referred to as FEBEX Dismantling Project (FEBEX-DP), was initiated in June 2014, with the objective of dismantling the test site, performing a post-mortem analysis of engineered and natural barrier components, and conducting joint analysis of the integrity of these barriers. The project continues to provide a unique opportunity for better understanding the performance of barrier components that underwent continuous heating and natural resaturation for a significant period. DOE joined the FEBEX-DP Project as one of the initial partners. UFD researchers participated in the planning and predictive modeling of the experiment, and currently are involved in the sample analysis and interpretation of long-term engineered barrier behavior.

SKB (Swedish Nuclear Fuel and Waste Management) Task Forces

The SKB Task Forces are a forum for international collaboration in the area of conceptual and numerical modeling of performance-relevant processes in natural and engineered systems (currently 12 partners). One task force focuses on flow and radionuclide migration processes in naturally fractured crystalline rock (GWFTS Task Force); another task force tackles remaining challenges in predicting the coupled behavior of the engineered barrier system (EBS Task Force). The task force topics center on experimental work conducted at the Äspö Hard Rock Laboratory (HRL) situated in crystalline rock. DOE joined both task forces in January 2014. UFD researchers are actively engaged in the interpretation and modeling of diffusion experiments conducted at the Äspö Hard Rock Laboratory (HRL) as well as at Onkalo in Finland.

HotBENT (Studying the Effects of High Temperatures on Clay Buffers/Nearfield)

Under NAGRA leadership, several international organizations (including U.S. DOE) are currently in the final planning stages of a new collaboration project referred to as HotBENT. The project addresses research needs related to the performance of clay buffers and near-field rock at temperatures above 150°C up to 200°C. Such temperatures may lead to potentially detrimental physicochemical changes of engineered and natural materials (pressure buildup and stress changes, secondary mineralization, cementation, illitization) and may induce complex moisture transport processes, including strong convection of vapor. Because the impact of such processes on the performance of a repository cannot be realistically reproduced and properly (non-conservatively) assessed at the smaller laboratory scale, the objective of HotBENT project is to plan and conduct a large in-situ experiment, most likely at the GTS in Switzerland. Substantial cost savings may be achieved in the design of a repository if HotBENT demonstrates that the maximum temperature can be raised without drastic performance implications. Potential HotBENT partners include institutions from Switzerland, Germany, Czech Republic, Japan, Great Britain and Sweden.

Bilateral Collaborations

UFD has also explored bilateral collaboration opportunities for active collaboration, and has selected additional R&D activities with potential for substantial technical advances. The status of selected opportunities and activities is described below.

- The Korea Atomic Energy Research Institute (KAERI) Underground Research Tunnel (KURT) is a generic underground research laboratory located in a shallow tunnel in a granite host rock, located in a mountainous area near Daejeon, Republic of Korea. In collaboration with the Korean Atomic

Energy Institute, UFD researchers are developing improved techniques for *in situ* borehole characterization, are testing methods for measuring streaming potential (SP) to characterize groundwater flow in a fractured formation, and are exchanging technical information regarding site characterization and buffer material specifications. This work is being performed under the Joint Fuel Cycle Studies agreement with the Republic of Korea.

- UFD and the German Federal Ministry of Education and Research (BMBWF) are collaborating on model benchmarking and data exchange for salt repositories in bedded salt (at the Waste Isolation Pilot Plant, WIPP, in New Mexico) and domal salt (at the Asse Mine in Germany). The U.S.-German collaboration currently focuses on modeling the temperature influence on the deformation behavior of rock salt. This is of particular importance for the design, operation, and evaluation of the long-term safety of underground repositories for disposal of high-level radioactive waste in rock salt.
- DOE and the National Radioactive Waste Management Agency of France (ANDRA) have recently signed a Memorandum of Understanding (MoU) regarding collaborative work in clay/shale disposal at the LSMHM Underground Laboratory near Bure, which is co-located with the French disposal site Cigeo in Meuse/Haute-Marne in the east of France. (LSMHM stands for Laboratoire de recherche Souterrain de Meuse/Haute-Marne, meaning an underground laboratory in the Meuse/Haute-Marne region in France.) Furthermore, under the umbrella of the DECOVALEX 2019 Project, UFD scientists have started modeling work to evaluate upscaling methods using heater test results ranging from small scale heating boreholes (TED experiment) to full-scale experiments (ALC experiment) at Bure.
- Other potential opportunities exist with disposal programs in Japan, Belgium, and Finland. The Horonobe (sedimentary) and Mizunami (crystalline) URLs in Japan are accessible for UFD participation under the JNEAP (Joint U.S.–Japan Nuclear Energy Action Plan) agreement. Belgium and Finland have strong R&D programs in geologic disposal and a long history of work in an underground research laboratory HADES (High Activity Disposal Experimental Site) URL in Belgium, Onkalo URL in Finland), and both countries are open to collaboration with UFD scientists.
- U.S.DOE is a member in Nuclear Energy Agency (NEA) collaborative initiatives, such as the NEA Thermochemical Database Project and the NEA Salt Club. The focus of these collaboration initiatives is less on active collaboration than on the exchange of information and shared approaches.

Status and Outlook

UFD has initiated a balanced portfolio of international R&D activities in disposal science, addressing relevant R&D challenges in fields like near-field perturbation, engineered barrier integrity, RN transport, and integrated system behavior. These now form a considerable portion of UFD disposal research, in particular in the Crystalline and Argillite work packages, and significant advances have been made over the past few years. The joint R&D with international researchers and the access to relevant data/experiments from a variety of URLs and host rocks has helped UFD researchers significantly improve their understanding of the current technical basis for disposal in a range of potential host rock environments. Comparison with experimental data has contributed to testing and validating predictive computational models for evaluation of disposal system performance in a variety of generic disposal system concepts. Comparison of model results with other international modeling groups, using their own simulation tools and conceptual understanding, have enhanced our confidence in the robustness of predictive models used for performance assessment. The possibility of linking model differences to particular choices in conceptual model setup provides guidance into “best” modeling choices and understanding the effect of model uncertainty. Promising opportunities exist for further expansion of the international program.

TABLE OF CONTENTS

EXECUTIVE SUMMARY	V
TABLE OF CONTENTS.....	X
LIST OF FIGURES	XIII
LIST OF TABLES.....	XXI
LIST OF ACRONYMS/INSTITUTIONS	XXII
1. INTRODUCTION.....	1
2. INTERNATIONAL OPPORTUNITIES AND STRATEGIC CONSIDERATIONS.....	3
3. MULTINATIONAL COOPERATIVE INITIATIVES.....	7
3.1 Mont Terri Project.....	7
3.1.1 Introduction to the Mont Terri Project.....	7
3.1.2 FE Heater Test	13
3.1.3 HE-E Heater Test	16
3.1.4 Engineered Barrier Experiment.....	19
3.1.5 FS Fault Slip Experiment.....	21
3.1.6 Mont Terri Summary	26
3.2 DECOVALEX Project.....	27
3.2.1 Introduction to the DECOVALEX Project	27
3.2.2 Modeling Tasks for DECOVALEX-2015	28
3.2.2.1 Task A: SEALEX Experiment at the Tournemire URL.....	30
3.2.2.2 Task B1: HE-E Heater Test at Mont Terri URL	34
3.2.2.3 Task B2: EBS Experiment at Horonobe URL.....	34
3.2.2.4 Task C1: THMC Processes in Single Fractures	37
3.2.2.5 Task C2: Bedrichov Tunnel Experiment.....	39
3.2.3 Modeling Tasks for DECOVALEX-2019	42
3.2.3.1 Task A: ENGINEER - Modeling Advective Gas Flow in Low Permeability Sealing Materials	45
3.2.3.2 Task B: Modeling the Induced Slip of a Fault in Argillaceous Rock.....	46
3.2.3.3 GREET: Groundwater Recovery around a Gallery in Crystalline Rock.....	48
3.2.3.4 Task D: INBEB - HM and THM Interactions in Bentonite Barriers.....	50
3.2.3.5 Task E: Upscaling of Heater Test Modeling Results from Small-scale to Full-scale.....	52
3.2.3.6 Task F: Finito - Fluid Inclusion and Movement in the Tight Rock.....	54
3.2.3.7 Task G: EDZ Evolution: Reliability, Feasibility, and Significance of Measurements of Conductivity and Transmissivity of the Rock Mass	55
3.2.4 DECOVALEX Summary.....	57
3.3 Grimsel Test Site Projects.....	58
3.3.1 Colloid Formation and Migration Project.....	59
3.3.1.1 Overview of the CFM Project	59
3.3.1.2 Colloid Formation and Migration Summary	63
3.3.2 FEBEX Dismantling Project.....	64
3.3.2.1 Introduction to FEBEX Dismantling Project	64

3.3.2.2	FEBEX-DP Objectives.....	66
3.3.2.3	FEBEX-DP Activities and Timeline	68
3.3.2.4	FEBEX-DP Summary	70
3.3.3	Other Experiments at Grimsel Test Site, Switzerland.....	71
3.3.3.1	HotBENT – A Proposed High-Temperature Heater Test.....	71
3.3.3.2	Other Experiments at GTS	73
3.4	SKB Task Forces	74
3.4.1	Introduction to SKB Task Forces.....	74
3.4.2	GWFTS Task Force	75
3.4.2.1	Task 8: Bentonite Rock Interaction Experiment (BRIE).....	75
3.4.2.2	Task 9: Modeling Two Diffusion - Sorption Experiments in Crystal Rock	77
3.4.3	EBS-THM Task Force	82
3.4.3.1	Homogenization Task.....	82
3.4.3.2	Prototype Repository	84
3.4.3.3	Potential Future EBS-THM Tasks and Outlook.....	86
3.4.4	EBS-C Task Force	86
3.4.4.1	Modeling Benchmarks	86
3.4.4.2	Potential Future EBS-C Tasks and Outlook.....	90
3.4.5	SKB Task Force Summary	91
3.5	NEA’s Cooperative Initiatives	92
3.5.1	NEA’s Clay Club	92
3.5.2	NEA’s Salt Club.....	93
3.5.3	NEA’s Thermochemical Database Project.....	94
3.5.4	NEA’s Repository Metadata (RepMET) Project	95
4.	BILATERAL COLLABORATION OPPORTUNITIES	97
4.1	Experiments at KURT URL, Republic of Korea	97
4.2	Salt Research Collaboration with German Researchers.....	100
4.3	Collaboration Opportunities at ANDRA’s LSMHM URL, France	103
4.4	Collaboration Opportunities with JAEA’s URLs in Japan	104
4.5	Collaboration Opportunities at HADES URL, Belgium.....	105
4.5.1	PRACLAY Test	106
4.5.2	Radionuclide Migration Experiments	107
4.6	Collaboration Opportunities at Onkalo URL, Finland.....	108
4.7	Collaboration Opportunities with COSC, Sweden.....	109
5.	SELECTION OF INTERNATIONAL COLLABORATION TASKS	111
6.	STATUS OF INTERNATIONAL COLLABORATION ACTIVITIES WITH FOCUS ON URL EXPERIMENTS.....	121
6.1	Near-Field Perturbation and EBS Integrity.....	121
6.1.1	THM Modeling of Heater Experiments	121
6.1.1.1	Introduction	121
6.1.1.2	Modeling of Mont Terri HE-E Experiment – DECOVALEX Task B1	122
6.1.1.3	Modeling of the Horonobe EBS experiment – DECOVALEX Task B2 ..	126
6.1.1.4	Modeling of FE Heater Test at Mont Terri	129
6.1.1.5	Summary of Modeling Heater Tests in Argillite Rocks.....	133
6.1.2	Modeling and Experimental Studies Related to the FEBEX-DP Project.....	133
6.1.2.1	Post-dismantling Modeling of the FEBEX-DP Data.....	134

6.1.2.2	Microstructural Analysis of the FEBEX-DP Data	138
6.1.3	Discrete Fracture Network (DFN) Modeling of the HG-A Experiment at Mont Terri	142
6.1.4	Modeling of THMC Processes in Single Fractures – DECOVALEX Task C1	145
6.1.5	Salt Geomechanics Modeling and Benchmarking	147
6.1.5.1	Reinvestigation into Closure Predictions of Room D at WIPP	147
6.1.5.2	Modeling Coupled THM Processes -Brine Migration in the TDSE Test..	150
6.2	Fluid Flow and Radionuclide Transport	153
6.2.1	Using Environmental Tracers to Estimate Fracture-Network Properties: Application to the Bedrichov Tunnel Experiment – DECOVALEX Task C2.....	153
6.2.2	Modeling Two Diffusion and Sorption Experiments in Crystalline Rock.....	157
6.2.3	Analysis of Colloid-Facilitated Radionuclide Transport	160
6.2.3.1	Synthesis of Colloid-Facilitated Radionuclide Transport	160
6.2.3.2	Modeling Colloid-Facilitated Transport for CFM Tests at Grimsel.....	162
6.3	Characterization and Monitoring Techniques	165
6.3.1	R&D Cooperation with KAERI at the KURT URL	165
6.3.2	Collaboration with COSC Project in Sweden on Deep Borehole Disposal	169
7.	BRIEF STATUS OF OTHER INTERNATIONAL COLLABORATION ACTIVITIES	174
7.1	Collaborative Salt Repository Research with Germany.....	174
7.2	Thermodynamic Modeling and Database Development.....	175
7.2.1	Thermochemical Database Project.....	175
7.2.2	Surface Complexation and Ion Exchange Database Development	176
7.3	Repository Metadata Project (RepMet)	177
7.4	Data Exchange on Bentonite Properties with KAERI	178
8.	SUMMARY	179
9.	ACKNOWLEDGMENTS	181
10.	REFERENCES	183

LIST OF FIGURES

Figure 3.1-1 3D schematic of the Mont Terri URL with side galleries and drifts. Pink area shows access gallery drilled for Mine-by Test and FE Heater Test (from Bossart 2012).....	9
Figure 3.1-2 List of main Mont Terri URL experiments conducted during Phase 21 (July 2015 through June 2016), displayed with respect to relevancy during different repository stages (from Bossart 2015).....	10
Figure 3.1-3 Plan view of the Mont Terri URL with key experiments. Gallery FE indicates the area of the FE Heater test, which is currently the largest subsurface heater experiment worldwide (Bossart 2016).....	11
Figure 3.1-4 Plan view of the Mont Terri URL with potential extension in mostly southwestward direction (from Bossart 2016).....	13
Figure 3.1-5 FE Heater Test at Mont Terri URL: experiment setup and borehole layout (from Zheng et al. 2015).....	14
Figure 3.1-6 FE Heater Test at Mont Terri URL: Side view of experiment setup and heater layout (Garitte 2010).	15
Figure 3.1-7 View from the FE gallery into the heater tunnel during final installation (Bossart 2014a).....	15
Figure 3.1-8 Images from the construction and installation of heaters, bentonite buffer and plugs (Zheng et al., 2016).....	16
Figure 3.1-9 Schematic setup of HE-E Heater Test at Mont Terri URL (Garitte et al. 2011).....	17
Figure 3.1-10 HE-E Heater Test at Mont Terri URL: Photo of micro-tunnel before buffer emplacement.	17
Figure 3.1-11 HE-E Heater Test at Mont Terri URL: Typical sensor placement (Gaus et al. 2014).	18
Figure 3.1-12 HE-E Heater Test at Mont Terri URL: Measured temperature inside compacted bentonite blocks near heater surface (Gaus et al. 2014).	18
Figure 3.1-13 Experimental layout of the EB experiment (Gens 2016).	19
Figure 3.1-14 EB experiment in the construction phase: canister mockup placed on bentonite blocks and hydration pipes (Gens 2016).	20
Figure 3.1-15 Positions of the 10 sensors in one vertical section of the EB Experiment: (1) relative humidity in buffer: WB21, WB22, WB23, WB24; and (2) pore pressure in rock: QB21_05, QB21_15, QB21_30, QB22_08, QB22_15, QB22_30 (Gens 2016).	20
Figure 3.1-16 Geologic setting showing Mont Terri URL and location of main fault (Guglielmi et al. 2015).....	22
Figure 3.1-17 Detailed fault geometry at Mont Terri (Guglielmi et al. 2015).....	22
Figure 3.1-18 (a) Fault slip test equipment setup; (b) Schematic view of the three-dimensional deformation unit. Tubes are differently colored to show that they display different deformations when there is a relative movement of the rings anchored to the borehole wall across the activated fracture; (c) Typical Step-Rate Test protocol (Guglielmi 2016).....	23
Figure 3.1-19 Test intervals across the Mt-Terri Main Fault (red squares are seismic sensors, blue squares are piezometers, blue rectangles are injection and monitoring intervals); A –	

Experiment location in Mt-Terri URL; B – Map of the boreholes geometry in the FS experiment zone and C – Cross section showing the different testing intervals in a simplified fault zone geology (Guglielmi 2016).....	24
Figure 3.1-20 Pressure and injected flowrate variations monitored in four injection intervals and one monitoring borehole. Dark blue is pressure in the injection interval, light-blue is pressure in the monitoring interval, and green is injection flowrate, m.e.q. indicates micro-earthquakes triggered during injection test 40.6m (Guglielmi et al. 2016).....	25
Figure 3.2-1. SEALEX Experiment at the Tournemire URL: Schematic setup of mini-tunnel with seal core and instrumentation (Barnichon and Millard 2012).	31
Figure 3.2-2. SEALEX Experiment at the Tournemire URL: Layout of mini-tunnels, access tunnels, and main gallery (Millard and Barnichon 2014).....	31
Figure 3.2-3 SEALEX Experiment at the Tournemire URL: View of mini-tunnel from gallery after seal emplacement (Barnichon 2011).	32
Figure 3.2-4 SEALEX Experiment at the Tournemire URL: Planned experiments and schedule (Barnichon 2011).....	32
Figure 3.2-5 Geologic cross section of the Tournemire URL (Barnichon 2011).....	33
Figure 3.2-6 Design of Horonobe URL (Sugita and Nakama 2012).	35
Figure 3.2-7 Design of EBS Experiment at Horonobe URL (Sugita and Nakama 2012).....	35
Figure 3.2-8 EBS Experiment: design of monitoring boreholes for sensor installation (from DECOVALEX web site, www.decovalex.org).	36
Figure 3.2-9 THMC behavior effects in a single fracture exposed to different external temperatures and varying stress conditions (Yasuhara et al. 2006).....	38
Figure 3.2-10 Fracture surface topography for the novaculite experiment (dimensions in mm) (DECOVALEX web site, www.decovalex.org).....	39
Figure 3.2-11 Bohemian granitic massif in Czech Republic and water inflow evidence in the Bedrichov Tunnel (Hokr and Slovak 2011).....	40
Figure 3.2-12 Profile of the tunnel with basic hydrogeological features and some measurement points (DECOVALEX web site, www.decovalex.org).	41
Figure 3.2-13 Example of numerical model of flow at the site, with combined 3D and 2D domains (Hokr et al. 2014).	41
Figure 3.2-14 Processes for movement of gas in low-permeability bentonite (Harrington 2016).....	45
Figure 3.2-15 Typical design and measurements from constant volume flow test conducted at BGS (Harrington et al. 2015).....	46
Figure 3.2-16 Basic design of fault slip experiment and measured deformation along and normal to fault plane (Graupner et al. 2016).....	47
Figure 3.2-16a Schematic showing GREET tunnel design in a cross-section and photos taken during construction (Iwatsuki 2016).....	48
Figure 3.2-17 Flowing and non-flowing fracture in closure test drift (CDT) (Sugita 2015).	49
Figure 3.2-18 Proposed experimental sequence for GREET task (Iwatsuki 2016).	49
Figure 3.2-19 Data from GREET used for prediction and validation of H-M-C models (Iwatsuki 2016).....	50

Figure 3.2-20 Example results from EB dismantling project: distribution of bentonite density in four different cross sections (Mayor and Gens 2015).....	51
Figure 3.2-21 Example results from FEBEX DP: distribution water content and saturation after 18 years of heating (Zheng 2016).....	51
Figure 3.2-22 French design for disposal in argillaceous rock, with waste packages stored in horizontal microtunnels (Vitel et al. 2016).....	52
Figure 3.2-23 Basic design of TED experiment conducted at Bure (Vitel et al. 2016).	53
Figure 3.2-24 Basic design of ALC experiment conducted at Bure (Vitel et al. 2016).....	53
Figure 3.2-26 Halite grain boundaries decorated with fluid inclusions (Shao 2016).	54
Figure 3.2-27 Fluid migration of a fluid inclusion in a salt grain, driven by the thermal gradient (Shao 2016).....	55
Figure 3.2-28 Top: hydraulic connectivity, expressed as relative pressure disturbance from <math><0.001</math> to 1. Bottom: transmissivities obtained from injection tests. The dotted red lines indicate areas where there is no observation of any hydraulic connectivity (Lanaro 2016).....	56
Figure 3.3-1 3D view of layout of the Grimsel Test Site in Switzerland (NAGRA 2010).....	58
Figure 3.3-2 Schematic illustration of the CFM field test bed at Grimsel Test Site (Reimus 2012).	60
Figure 3.3-3 CFM field test bed at Grimsel Test Site: Tunnel packer system used to isolate the shear zone (http://www.grimsel.com/gts-phase-vi/cfm-section/cfm-site-preparation). Small disks with tubing issuing from them (inside yellow packer) are “surface packers” that seal the tunnel wall and collect water from inflow points. Tunnel diameter is 3.5 meters.....	60
Figure 3.3-4 CFM field test bed at Grimsel Test Site: Borehole layout and test locations for all tracer tests 2001-2012 (Reimus 2012).	61
Figure 3.3-5 Plan view of the borehole configuration for the LIT (left) and photo showing the boreholes at the access tunnel wall (right).....	62
Figure 3.3-6 Schematic cross section of the FEBEX Test at Grimsel Test Site (NAGRA 2014).	65
Figure 3.3-7 <i>In situ</i> test configuration following dismantling of Heater 1 (Huertas et al. 2005).....	65
Figure 3.3-8 Spatial distribution of degree of saturation at section 37 (see Figure 3.3-10 for the position of section 37) (Zheng et al. 2016).....	66
Figure 3.3-9 Primary goals of FEBEX-DP Project (NAGRA 2014).	67
Figure 3.3-10 Sampling cross-sections (numbers in circles are cross-section numbers) for FEBEX-DP Project (NAGRA 2014).	69
Figure 3.3-11 An overcore that preserves the interface between shotcrete and bentonite (Zheng et al., 2016).....	69
Figure 3.3-12 The front of dismantling section 62 with the core samples taken for microbiological studies, the blue bar prevents the partially detached bentonite from collapsing (Zheng et al., 2016).....	70
Figure 3.3-13 Design modules for HotBENT from partners of the project (Kober 2016).....	72

Figure 3.3-14 GAST Experiment at Grimsel Test Site: Schematic picture of repository seal design with 8–10 m long sand/bentonite plug in between two gravel packs and a concrete plug for reinforcement (from http://www.grimsel.com/gts-phase-vi/gast/gast-introduction).	73
Figure 3.4-1 Layout of Äspö HRL and location of main experiments (Birkholzer 2012).....	74
Figure 3.4-2 Schematic presentation of the stages of the BRIE Experiment at Äspö HRL (Bockgård et al. 2012).	76
Figure 3.4-3 BRIE Experiment at Äspö HRL: The test niche and five boreholes (distance 1.5 m) used for initial characterization and selection of BRIE site (SKB 2011b).	77
Figure 3.4-4 Schematic layout of LTDE-SD at Äspö HRL (SKB 2011a).....	78
Figure 3.4-5 Illustration of the sampling of the overcored rock volume in LTDE-SD (SKB 2011a).	79
Figure 3.4-6 Results from the in-situ in-diffusion experiment LTDE-SD through a natural fracture surface. Modeled Na-22 and Cl-36 penetration profiles (solid curves) are compared to the measured profiles (diamonds). Na-22 activities in the rock matrix were obtained on intact or crushed rock slices and Cl-36 activities were obtained by leaching of intact or crushed slices (Viswanathan et al., 2016).	80
Figure 3.4-7 The REPRO Niche at the 401 m level at ONKALO, and the nine boreholes drilled from the niche. Borehole PP323 is utilized for WPDE-1&2, and boreholes PP324, PP326, and PP327 for TDE (Viswanathan et al., 2016).	81
Figure 3.4-8 Top: Schematic view of device geometry used in the large-scale buffer homogenization experiments. Bottom: Photo of the device showing the lid, inlets, and sensors along with bentonite block (Börgesson et al. 2015).....	83
Figure 3.4-9 Schematic layout of Prototype Repository at Äspö HRL (SKB 2011a, b).....	84
Figure 3.4-10 Prototype Repository at Äspö HRL: Photo of excavated deposition hole.	85
Figure 3.4-11 Experimental setup for Benchmark 1 involving salt diffusion experiment in montmorillonite (Birgersson 2011; Birgersson et al. 2009).	87
Figure 3.4-12 Sample configurations for Benchmark 2 experiments (Birgersson 2011).	88
Figure 3.4-13 Experimental setup for Benchmark 3 to investigate ion exchange and effect on swelling pressure (Birgersson 2011; Birgersson et al. 2009).	88
Figure 3.3-14 Schematic diagram of percolation experiment setup for compacted bentonite (Birgersson 2011).	89
Figure 3.4-15 Schematic diagram showing diffusion cell used in Benchmark 5 (Birgersson 2011; Hofmanová and Červinka 2014).....	90
Figure 4.1-1 Layout of the KURT URL in Daejeon, Korea before extension (KAERI 2011).	98
Figure 4.1-2 Layout for tunnel extension of KURT (Wang et al. 2014).....	98
Figure 4.1-3 Location of <i>in situ</i> tests and experiments with related boreholes at KURT (from Wang et al. 2014).....	99
Figure 4.1-4 Specification of DB-2 borehole and its location near KURT site (from Wang et al. 2014).....	99
Figure 4.2-1 View of one of the underground tunnels at Gorleben at the 840 m level (BMW 2008).....	101

Figure 4.2-2 Schematic view of the two drift tests used in the TSDE experiment (800 m level of the Asse salt mine) (Ruqvist et al. 2015).....	102
Figure 4.2-3 Locations of Rooms B and D at WIPP (Reedlunn et al. 2016).....	102
Figure 4.3-1 Layout of the LSMHM URL at Bure, France (Lebon 2011).	103
Figure 4.3-2 LSMHM URL at Bure, France (from http://www.andra.fr/download/andra-international-en/document/355VA-B.pdf).....	104
Figure 4.4-1 Layout of the Mizunami Underground Research Laboratory in Japan, and photo of tunnel shaft construction (http://www.jaea.go.jp/04/tono/miu_e/).....	105
Figure 4.5-1 Layout of the HADES URL in Mol, Belgium (Li 2011).	106
Figure 4.5-2 Layout of the PRACLAY <i>in situ</i> experiment at HADES URL (Li 2011).....	106
Figure 4.5-3 PRACLAY <i>in situ</i> experiment at HADES URL: Configuration of boreholes for pressure, stress, displacement, and water chemistry measurements (Li 2011).....	107
Figure 4.5-4 PRACLAY <i>in situ</i> experiment at HADES URL: Photo on left shows hydraulic seal from the outside, with an access hole to the right, which soon will be closed. Photo on right was taken from access hole into the heater gallery section, which is currently being backfilled.	107
Figure 4.5-5 Schematic of CP1 Diffusion Experiment at HADES URL (Maes et al. 2011).....	108
Figure 6.1-1 TOUGH-FLAC 3-D model of the Mont Terri HE-E experiment (Zheng et al. 2015).....	123
Figure 6.1-2 Comparison of simulated (dashed lines) and measured (solid lines) evolutions of (a) liquid saturation relative humidity and (b) temperature after interpretative modeling (Zheng et al. 2016).....	124
Figure 6.1-3 Comparison of modeled (dashed lines) and measured (solid lines) evolutions of pore pressure in Opalinus Clay at located 3.54 m from the tunnel after interpretative modeling (Zheng et al. 2016).....	124
Figure 6.1-4 Comparison of predicted (lines) and measured (symbols) evolutions of temperature and relative humidity at points located 10 cm (in granular bentonite, white square in left figures) and 7 cm (in bentonite blocks, bigger white circle in left figures)) for eight modeling teams within the DECOVALEX-2015 project. Solid lines for modeling results in granular bentonite and dashed lines for modeling results in bentonite blocks (Zheng et al. 2016).....	125
Figure 6.1-5 TOUGH-FLAC 3D numerical grid of the Horonobe EBS experiment (Zheng et al. 2016).....	126
Figure 6.1-6 EBS Experiment: TOUGH-FLAC simulation results of temperature in the buffer and rock (from Zheng et al. 2015).....	127
Figure 6.1-7 Comparison of simulated temperature profiles at 10 and 365 days among the DECOVALEX modeling teams (Zheng et al. 2015).....	127
Figure 6.1-8 (a) Predicted and measured temperature evolution at three monitoring points in the buffer and (b) map view and vertical cross-section of the test pit monitoring points (Zheng et al. 2016).....	128
Figure 6.1-9 (a) Predicted and measured stress evolution at four monitoring points in the buffer, and (b) map view and vertical cross-section of the test pit with monitoring points (Zheng et al. 2016).....	128

Figure 6.1-10 TOUGH-FLAC 3D numerical grid of the FE experiment (Zheng et al. 2016).....	130
Figure 6.1-11 Comparison of modeled (lines) and measured (symbols) evolutions of relative humidity at monitoring points located in (a) granular bentonite and (b) bentonite blocks (Zheng et al. 2016).....	131
Figure 6.1-12 Comparison of modeled (lines) and measured (symbols) evolutions of relative humidity at monitoring points located in (a) granular bentonite and (b) bentonite blocks for a diffusion tortuosity factor of 0.14 (Zheng et al. 2016).....	132
Figure 6.1-13 Measured temperature by sensor located at radial distance 1.05 m in sections E2 and F2 and model results from the TH model and THMC model with linear swelling (THMC-LS) (Zheng et al. 2016).	135
Figure 6.1-14 Measured water content data at cross sections 19, 28 and 29 and cross sections 22 and 27 (Daucousse and Lloret 2003) after the dismantling of heater #1 (“data 5.3 yrs.”) and at cross section 49 after the dismantling of heater #2 (“data 18.3 yrs.”) and model results from the TH model (TH), and the THMC model with linear swelling (THMC-LS) (Zheng et al. 2016).....	136
Figure 6.1-15 The measured concentration profile of calcium at 5.3 years and model results from a THC model versus a THMC model with linear swelling (THMC-LS) (Zheng et al. 2016).....	137
Figure 6.1-16 Graphical results of the micro CT analysis of two samples from section 48: BD-48-3 (near the heater) and BD-48-7 (near the granite) (Zheng et al. 2016).....	139
Figure 6.1-17 Results from the high-resolution SXR- μ CT measurement on sample BD-48-7. The voids have been highlighted in red (Zheng et al. 2016).....	139
Figure 6.1-18 Photographs of the overcoring method (left), shotcrete-bentonite overcore sample (center) and the X-ray CT image (right) focusing on the interface region (Jove-Colon 2016).....	140
Figure 6.1-19 Micro-XRF maps for Ca and S at the shotcrete-bentonite interface. An apparent depletion zone close to the shotcrete-bentonite interface is delineated by red-dashed lines.....	141
Figure 6.1-20 a) Excavation damage viewing from the HG-A Niche toward back end (Marschall et al. 2006); and b) Conceptual diagram of the damage zone (Lanyon et al. 2009).	143
Figure 6.1-21 a) Discretization of the computational domain for the HG-A test simulation; b) nonuniform fracture pattern around the tunnel; and c) deformed shape of the borehole (Zheng et al. 2014).....	143
Figure 6.1-22 Discretizations of the computational domain for the HG-A test simulations: a) without fault planes; and b) with fault planes explicitly modeled into the grid (Zheng et al. 2016).....	144
Figure 6.1-23 Resulting failure patterns around the tunnel excavation zone: a) without fault planes; and b) with fault planes (Zheng et al. 2016).....	144
Figure 6.1-24 Spontaneous initiation of aperture channeling. As the fracture aperture reduces due to pressure dissolution, the preferred wavelength of dissolution fingering decreases. Once the preferred wavelength falls within the experimental observation range, a spontaneous initiation of preferential channeling can be observed. This may be responsible for the observed spontaneous switch from a net permeability reduction to a net permeability increase with no changes in a limestone fracture experiment (Wang et al. 2015; 2016).....	146

Figure 6.1-25 Schematic illustration of the process of deriving the fracture aperture maps from the laboratory measurements (Bond 2016).....	146
Figure 6.1-26 Rooms B and D dimensions (Reedlunn 2016).....	148
Figure 6.1-27 Photographs of Rooms B and D (Reedlunn 2016).....	149
Figure 6.1-28 Horizontal and vertical closure measurements of Rooms B and D (Reedlunn 2016).....	149
Figure 6.1-29 TSDE test: (a): cross-section of the Asse salt mine, indicating the location of the TSDE experiment; (b): schematic representation of the test area (Blanco-Martin et al. 2016).....	150
Figure 6.1-30 TSDE test: views of the initial mesh used in the geomechanics sub-problem. The main dimensions of the model are also shown (Rutqvist et al. 2016; Blanco-Martin et al. 2016).....	151
Figure 6.1-31 TSDE test: backfill porosity in the heated area and in the non-heated area. Points represent measurements, solid lines correspond to TOUGH-FLAC and dashed lines correspond to FLAC-TOUGH (Rutqvist et al. 2016).....	152
Figure 6.2-1 Measured and modelled stable isotope δD compositions for the Bedrichov collection canal using the exponential age distribution (Wang et al. 2014).....	155
Figure 6.2-2 Transport sequence of tracer migration from a selected PFLOTRAN simulation run. Note that tracer concentration is contoured in log scale. Fracture plane on left side of domain, tunnel on right (front) of domain (Wang et al. 2014).....	155
Figure 6.2-3 Transient recharge, modeled fracture discharge and observed discharge (Wang et al. 2015).....	156
Figure 6.2-4 Transient $\delta^{18}O$ in precipitation (red line), modeled $\delta^{18}O$ in the fracture outflow (green line) and observed $\delta^{18}O$ (blue dots) in fracture outflow (Wang et al. 2015).....	156
Figure 6.2-5 The measured experimental shapes of the Cs penetration profile (symbols) do not satisfy modeled penetration profile (dashed line). Penetration depth is given in cm (Viswanathan et al. 2016).....	157
Figure 6.2-6 Permeability (left) and porosity (right) profiles are shown in the fracture continuum simulation (Viswanathan et al. 2016).....	158
Figure 6.2-7 Tracer concentration of transport modeling in fractured continuum (Viswanathan et al. 2016).....	158
Figure 6.2-8 Simulation results of tracer concentration plotted versus tracer penetration depth. Blue line corresponds to fractured continuum model with simulated ADE, dashed green line shows results for uniform continuum with simulated pure diffusion process (Viswanathan et al. 2016).....	159
Figure 6.2-9 The cross section of the entire mesh along the boreholes, along z direction. The distance between central borehole and two others is 0.15 m. the zoom in figure shows the mesh of dummy filled boreholes and 1 mm layer between dummy and rock matrix (Viswanathan et al. 2016).....	160
Figure 6.2-11 Model matches to the AGA, colloid, Na, Cs, Ba and Np breakthrough curves of CFM Run 12-02. Modeled solute and colloid contributions shown (Viswanathan et al. 2016).....	164
Figure 6.2-12 Model matches to the colloid, Pu, and Am breakthrough curves of CFM Run 12-02. Both species modeled as colloid-facilitated transport (Viswanathan et al. 2016).....	164

Figure 6.3-1 3-D view of sandbox design (Wang et al. 2015; 2016).....	165
Figure 6.3-2 Cross-sectional view of sandbox design (Wang et al. 2015; 2016)	166
Figure 6.3-3 Full setup of a sandbox experiment (Wang et al. 2015; 2016).....	166
Figure 6.3-4 Electrode set up into the sandbox (Wang et al. 2016).....	167
Figure 6.3-5 Measured SP signals and Cl^- concentrations during the sandbox tracer experiment. Black dotted boxes indicate timing of tracer injection (Wang et al. 2016).	168
Figure 6.3-6 Schematic for FFEC logging method. Q is pump flow rate, $\Delta(\text{FEC})$ is change in electrical conductivity, q is inflow rate and C is salinity of the formation water (Dobson et al. 2016).	169
Figure 6.3-7 Comparison of the results of observations with modeling: BORE II fit to the FFEC profiles 1, using the Low- C approach (Dobson et al. 2016).....	170
Figure 6.3-8 Test 3 and Test 4 operating conditions showing wellbore hydraulic head, with logging periods shown (Dobson et al. 2016).	171
Figure 6.3-9 Core samples obtained for two of the hydraulically conductive inflow zones, showing distinct open fracture zones intersecting the borehole (Dobson et al. 2016).....	171

LIST OF TABLES

Table 3.1-1 Participation of International Programs in Cooperative Initiatives Related to URLs: Status September 2016.	8
Table 3.2-1 Modeling Test Cases for DECOVALEX-2015 (from Jing and Hudson 2011).	29
Table 3.2-2 Seven task proposals were selected for inclusion in DECOVALEX-2019, based on the level of interest from funding organizations. As is generally the case in DECOVALEX, most of the modeling tasks involve data from experiments conducted in URLs:	42
Table 3.2-3 Modeling Test Cases for DECOVALEX-2019 (from Bond and Birkholzer 2016).	44
Table 5-1 Example of the 2014 Summary and Ranking Table of International Programs in Cooperative Initiatives Related to URLs: Status September 2014. The FEPs ranking is based on Tables 7 and 8 in Nutt (2011). Table entries are sorted by URLs.	114
Table 5-2 Recent, Current and Future Work Package Activities with International Collaboration and Focus on URL Experiments (sorted by URL)	119

LIST OF ACRONYMS/INSTITUTIONS

ANDRA	National Radioactive Waste Management Agency, France
BGR	Federal Institute for Geosciences & Natural Resources, Germany
BMT	Benchmark Test
BMWi	Ministry for Economy and Labor, Germany
BRIE	Bentonite Rock Interaction Experiment, Äspö HRL, Sweden
CAS	Chinese Academy of Sciences, China
CFM	Colloid Formation and Migration Project, Grimsel Test Site, Switzerland
CIEMAT	Centro Investigaciones Energéticas Medioambientales y Tecnológicas, Madrid, Spain
CRIEPI	Central Research Institute of Electric Power Industry, Japan
CRR	Colloid and Radionuclide Retardation Project, Grimsel Test Site, Switzerland
DECOVALEX	Development of Coupled Models and their Validation Against Experiments
DFN	Discrete Fracture Network
DOE	Department of Energy, USA
DR-A	Diffusion, Retention, and Perturbation Experiment, Mont Terri, Switzerland
EBS	Engineered Barrier System
EDZ	Excavation Damage Zone (or Excavation Disturbed Zone)
ENRESA	National Radioactive Waste Corporation, Spain
ENSI	Swiss Federal Nuclear Safety Inspectorate, Switzerland
FANC	Federal Agency for Nuclear Control, Belgium
FE	Full-scale Emplacement Experiment, Mont Terri, Switzerland
FEBEX	Full-scale High Level Waste Engineered Barriers Experiment, Grimsel Test Site, Switzerland
FEBEX-DP	FEBEX Dismantling Project
FEPs	Features, Events, and Processes
FORGE	Fate of Repository Gases Experiment, Grimsel Test Site, Switzerland
FS	Faults Slip Hydro-Mechanical Characterization Experiment, Mont Terri, Switzerland
GAST	Gas-Permeable Seal Test, Grimsel Test Site, Switzerland
GRS	Gesellschaft für Anlagen- und Reaktorsicherheit mbH, Germany

GTS	Grimsel Test Site, Switzerland
GWFTS	Groundwater Flow and Transport Task Force, Sweden
HADES	High Activity Disposal Experimental Site, Mol, Belgium
HG-A	Gas Path through Host Rock and Seals Experiment, Mont Terri, Switzerland
HE-E	In Situ Heater Experiment in Micro-tunnel, Mont Terri, Switzerland
HLW	High-Level Waste
HM	Hydro-mechanical
HMC	Hydro-mechanical-chemical
HPPP	High-Pulse Poroelasticity Protocol
HRL	Hard Rock Laboratory
IGSC	Integration Group for the Safety Case
IRSN	Institut de Radioprotection et de Sûreté Nucléaire, France
JAEA	Japan Atomic Energy Agency, Japan
JFCS	U.S.–Korea Joint Fuel Cycle Studies
JNEAP	U.S.–Japan Nuclear Energy Action Plan
KAERI	Korea Atomic Energy Research Institute, Republic of Korea
KIT	Karlsruhe Institute of Technology, Karlsruhe, Germany
KTH	Royal Institute of Technology, Stockholm, Sweden
KURT	KAERI Underground Research Tunnel, Republic of Korea
LANL	Los Alamos National Laboratory, USA
LBNL	Lawrence Berkeley National Laboratory, USA
LLNL	Lawrence Livermore National Laboratory, USA
LIT	Long-term in-situ test, Grimsel Test Site, Switzerland
LSMHM	Laboratoire de recherche Souterrain de Meuse/Haute-Marne
LTD	Long-Term Diffusion, Grimsel Test Site, Switzerland
LTDE-SD	Long-Term Diffusion Sorption Experiment, Äspö HRL, Sweden
MD	Molecular dynamics
MoU	Memorandum of Understanding
MWCF	Major Water Conducting Feature
NAGRA	National Cooperative for the Disposal of Radioactive Waste, Switzerland

NBS	Natural Barrier System
NE	DOE Office of Nuclear Energy, USA
NEA	Nuclear Energy Agency
NRC	Nuclear Regulatory Commission, USA
NWMO	Nuclear Waste Management Organization, Canada
OBAYASHI	Construction, Engineering and Management Company, Japan
PA	Performance Assessment
POSIVA	Nuclear Waste Management Organization, Finland
PUNT	U.S.–China Peaceful Uses of Nuclear Technology
RWM	Radioactive Waste Management Limited, UK
R&D	Research and Development
SURAO	Radioactive Waste Repository Authority, Czech Republic
RBSN	Rigid-Body-Spring Network
RELAP	REactive Transport LAPlace Transform
REPRO	Rock Matrix Retention Properties, Onkalo URL, Finland
ROK	Republic of Korea
SA	Safety Assessment
SCK/CEN	Belgian Nuclear Research Centre, Belgium
SKB	Swedish Nuclear Fuel and Waste Management, Sweden
SNF	Spent Nuclear Fuel
SNL	Sandia National Laboratories, USA
SSM	Swedish Nuclear Waste Regulator
Swisstopo	Federal Office of Topography, Switzerland
TC	Test Case
TDB	Thermochemical Database
TDE	Through Diffusion Experiment
THC	Thermo-hydro-chemical
THM	Thermo-hydro-mechanical
THMC	Thermo-hydro-mechanical-chemical
TSDE	Thermal Simulation for Drift Emplacement Experiment, Asse II Mine, Germany

TUC	Clausthal University of Technology, Germany
UFD	Used Fuel Disposition Campaign, USA
UFZ	Umweltforschungszentrum Leipzig-Halle, Germany
UPC	Polytechnic University of Catalonia, Barcelona, Spain
URL	Underground Research Laboratory
WPDE	Water Phase Diffusion Experiment
WIPP	Waste Isolation Pilot Plant, New Mexico, USA

This page is intentionally blank.

1. INTRODUCTION

After decades of focusing geologic disposal Research & Development (R&D) on open tunnel emplacement in unsaturated fractured tuff, the United States' interest has shifted to alternative host rocks (e.g., clay, crystalline, salt), hydrogeologic conditions (i.e., saturated, reducing), and repository designs (e.g., bentonite backfill and seals). These alternatives are similar to those that were investigated by international geologic disposal programs in Europe and Asia. Close collaboration with these programs allows U.S. researchers (1) to benefit from a deep knowledge base in regards to alternative repository solutions developed over decades, and (2) to utilize international investments in research facilities (such as underground research laboratories), saving millions of R&D dollars that have been and are being provided by other countries. In 2012, the U.S. Department of Energy (DOE) embarked on a comprehensive effort to identify international collaboration opportunities in disposal research, to interact with international organizations and advance promising collaborations, and to plan/develop specific R&D activities in cooperation with international partners. To date, DOE has established formal collaboration agreements with five international initiatives and several international partners, and has conducted some specific collaborative R&D activities that align well with its R&D priorities. Several promising opportunities exist for further expansion of the program with relatively modest additional investment.

This report describes the status of international collaboration regarding geologic disposal research in the Used Fuel Disposition (UFD) Campaign. The focus of the report is on opportunities that provide access to field data (and respective interpretation and modeling), and/or allow participation in ongoing and planned field experiments. The report is an update to earlier reports summarizing UFD's international activities (*Status of UFD Campaign International Activities in Disposal Research, FCRD-UFD-2012-000295, September 2012* Birkholzer 2012, *International Collaboration Activities in Different Geologic Disposal Environments, FCRD-UFD-2014-000065, September 2014* Birkholzer 2014), and *International Collaboration Activities in Different Geologic Disposal Environments, FCRD-UFD-20154-000079, September 2015* Birkholzer 2015).

This page is intentionally blank.

2. INTERNATIONAL OPPORTUNITIES AND STRATEGIC CONSIDERATIONS

Recognizing the benefits of international collaboration toward the common goal of safely and efficiently managing the back end of the nuclear fuel cycle, DOE's Office of Nuclear Energy (NE) and its Office of Used Fuel Disposition Research and Development have developed a strategic plan to advance cooperation with international partners (UFD 2012). International geologic disposal programs are at different maturation states, ranging from essentially "no progress" in some countries to selected sites and pending license applications in others. The opportunity exists to collaborate at different levels, ranging from providing expertise to those countries "behind" the U.S. to sharing information and expertise with those countries that have mature programs (*Used Fuel Disposition Campaign International Activities Implementation Plan, FCRD-USED-2011-000016 REV 0, November 2010* (Nutt 2010)). Working with other countries optimizes limited resources by integrating knowledge developed by researchers across the globe (UFD 2012).

UFD's strategic plan lays out two interdependent areas of international collaboration (UFD 2012). The first area is cooperation with the international nuclear community through participation in international organizations, working groups, committees, and expert panels. Such participation typically involves conference and workshop visits, information exchanges, reviews, and training and education. Examples include multinational activities, such as under International Atomic Energy Agency (IAEA) (e.g., review activities, conference participation, and education), OECD/Nuclear Energy Agency (NEA) (e.g., participation in annual meetings, Integration Group for the Safety Case membership, NEA Thermochemical Database, NEA's Clay Club, NEA's Salt Club), and EDRAM (International Association for Environmentally Safe Disposal of Radioactive Waste). DOE also actively supports bilateral agreements such as PUNT (U.S.-China Peaceful Uses of Nuclear Technology), JNEAP (U.S.-Japan Nuclear Energy Action Plan), and the U.S.-Germany Memorandum of Understanding for Cooperation in the Field of Geologic Disposal of Radioactive Wastes. UFD will continue participation in and/or support of ongoing international collaborations in this first area, will assess their benefits, and will identify the need for expanding or extending their scope. New activities and agreements may be developed with an eye toward the objectives and R&D needs of the United States (UFD 2012).

The second area of international collaboration laid out in the strategic plan involves active R&D participation of U.S. researchers within international projects or programs (UFD 2012). By active R&D, it is meant here that U.S. researchers work closely together with international scientists on specific R&D projects relevant to both sides. With respect to geologic disposal of radioactive waste, such active collaboration provides direct access to information, data, and expertise on various disposal options and geologic environments that have been collected internationally over the past decades. Many international programs have been operating underground research laboratories (URLs) in clay/shale, granite, and salt environments, in which relevant field experiments have been and are being conducted. Depending on the type of collaboration, U.S. researchers can participate in planning, conducting, and interpreting experiments in these URLs, and thereby get early access to field studies without having *in situ* underground research facilities in the United States.

UFD considers this second area, active international R&D, to be very beneficial to the program, helping to efficiently achieve the program's key disposal research goals, such as short- and medium-term research objectives as described in *Update of the Used Fuel Disposition Campaign Implementation Plan (FCRD-UFD-2014-000047, September 2014)* (Bragg-Sitton et al. 2014). For example, the Campaign Implementation Plan calls for 5-year objectives of achieving a “comprehensive understanding of the current technical basis for disposal of used nuclear fuel and high-level nuclear waste in a range of potential disposal environments to identify long-term R&D needs” and developing “advanced, predictive computational models, with experimental validation, for evaluation of disposal system performance in a variety of generic disposal system concepts and environments.” These research goals and objectives were formulated under the assumption of specific target dates for geologic repository development set out in the 2013 *DOE Strategy for the Management and Disposal of Used Nuclear Fuel and High-Level Radioactive Waste* (<http://energy.gov/downloads/strategy-management-and-disposal-used-nuclear-fuel-and-high-level-radioactive-waste>). With the caveat that full execution of the DOE strategy requires enactment of revised legislative authority dates, the target dates identified are, respectively, Year 2026 to have a repository sited, Year 2042 to have it characterized, designed, and licensed, and finally, Year 2048 for a repository constructed and operations commenced.

In 2012, it was decided that the UFD campaign priority should focus on advancing and utilizing such active international collaboration in disposal research. Coordinated by Lawrence Berkeley National Laboratory, USA (LBNL), a focused effort was made to collect information on international opportunities that complement ongoing disposal R&D within the UFD, help identify those activities that provide the greatest potential for substantive technical advances, interact with international organizations and programs to help advance specific collaborations, and initiate specific R&D activities in cooperation with international partners. Active collaboration can be achieved under different working models. One option stems from informal peer-to-peer interaction with international R&D organizations. Many U.S. scientists involved in UFD research activities have close relationships with their international counterparts, resulting from workshops and symposia meetings, or from active R&D collaboration outside of UFD. Continued UFD support for participation of U.S. researchers in relevant international workshops, meetings, conferences and symposia will help to foster discussion and expand such relationships.

Other working models for active international collaboration require that DOE becomes a formal member in multinational initiatives. Dr. Jens Birkholzer from LBNL, UFD's coordinator for international collaboration in disposal research, identified and examined several such multinational opportunities and made recommendations to DOE/UFD leadership as to which initiatives would be most beneficial. Since 2012, DOE has joined five international cooperation initiatives as a formal partner, the DECOVALEX Project, the Mont Terri Project, the Colloid Formation and Migration Project (2012 through 2015), the Full-scale High Level Waste Engineered Barriers Experiment, Grimsel Test Site, Switzerland (FEBEX) Dismantling Project, and the SKB (Swedish Nuclear Fuel and Waste Management) Task Forces. All of these provide access to field data from URLs and/or allow participation in ongoing and planned URL field experiments. Section 3 of this report gives a comprehensive overview of these initiatives and describes the various opportunities arising from DOE's membership. Outside of the above initiatives, UFD scientists can also collaborate with individual international disposal programs, which may or may not require formal bilateral agreements. Section 4 presents an overview of the international disposal programs that are open to bilateral collaboration with U.S. researchers.

The benefit of international collaboration needs to be evaluated, and periodically reevaluated, in the context of the open R&D issues that can be addressed through collaborative scientific activities. Open R&D issues with respect to Natural Barrier System (NBS) behavior are summarized in UFD reports (e.g., *Natural System Evaluation and Tool Development – FY10 Progress Report, August 2010* (Wang 2010)); specific R&D issues related to clay/shale host rock are discussed, for example, in Tsang et al. (2011). Engineered Barrier System (EBS)-related R&D items have also been considered in previous progress

reports (e.g., Jove-Colon et al. 2010). All R&D gaps identified in these reports have been evaluated in consideration of their importance to the safety case in a recently conducted roadmap exercise (*Used Fuel Disposition Campaign Disposal Research and Development Roadmap, FCRD-USED-2011-000065 Rev 0, March 2011; Tables 7 and 8; (Nutt 2011)*). The ranking of features, events, and processes (FEPs) in this roadmap report founded the basis for identifying the most relevant and promising international opportunities. Section 5 describes the planning exercise conducted by UFD in FY11 and FY12, which led to the initial selection of a set of R&D activities that align with current goals, priorities, and funded plans of UFD. Section 5 also points to the need for periodic reassessment of its international research portfolio, as research priorities and boundary conditions change and as new opportunities for collaboration develop. Results from such reassessment, conducted in FY15 and FY16, are briefly described in Section 5.

The status of R&D activities conducted in FY16 (including some main activities from FY15) is described in the remainder of the report. Section 6 is dedicated to R&D work with primary focus on participation in, and analysis of, URL experiments. Example R&D results are presented, albeit without providing exhaustive explanations. Ongoing international collaboration activities unrelated to URLs are briefly mentioned in Section 7.

This page is intentionally blank.

3. MULTINATIONAL COOPERATIVE INITIATIVES

This section gives a comprehensive overview of the five international cooperation initiatives that DOE has joined as a formal partner. These are the Mont Terri Project, the DECOVALEX Project, the Colloid Formation and Migration Project (CFM), the FEBEX Dismantling Project, and the SKB Task Forces. (Note that in July 2015, a DOE made the decision to discontinue its partnership in the Colloid Formation and Migration Project, due to cost/benefit considerations; however, UFD researchers continue to collaborate informally with CFM activities.) Table 3.1-1 lists the international waste disposal organizations currently participating in those five initiatives, sorted by country. The table demonstrates the high level of cooperation between nuclear nations. As mentioned before, the focus of DOE's international collaboration strategy is on initiatives that foster active research with other international disposal programs, provide access to field data (and respective interpretation/modeling), and/or may allow participation in ongoing and planned field experiments in URLs (Sections 3.1 to 3.4). Section 3.5 briefly touches on other international collaboration initiatives organized by the Nuclear Energy Agency (NEA) where the focus is less on active collaboration and more on the exchange of information and shared approaches.

3.1 Mont Terri Project

3.1.1 Introduction to the Mont Terri Project

The Mont Terri Project is an international research project for the hydrogeological, geochemical, and geotechnical characterization of a clay/shale formation suitable for geologic disposal of radioactive waste (Zuidema 2007; Bossart and Thury 2007). The project, which was officially initiated in 1996, has been conducted in a clay-rock underground rock laboratory, which lies north of the town of St-Ursanne in northwestern Switzerland and is located at a depth of ~300 m below the surface in argillaceous claystone (Opalinus Clay). The rock laboratory is located in and beside the security gallery (initially the reconnaissance gallery) of the Mont Terri motorway tunnel, which was opened to traffic at the end of 1998. The rock laboratory consists mainly of eight small niches along the security gallery, excavated in 1996, Gallery 98 with 5 lateral niches, excavated in 1997/98, a gallery for the EZ-A experiment, excavated in 2003, Gallery 04 with 4 lateral niches, excavated in 2004, and lastly, Gallery 08 with side galleries for the Mine-by Test and Full-scale Emplacement Experiment, Mont Terri, Switzerland (FE) Heater Test, excavated in 2008 (Figure 3.1-1).

The Mont Terri Project essentially operates as a collaborative program providing open access to an existing URL. The research program consists of a series of individual experiments divided into annual project phases, running from July 1 in one year to June 30 the next year. The Swiss Federal Office of Topography, Swisstopo, helps with the operation and maintenance of the rock laboratory, and provides the operational management and experimental support. The research-partner organizations fund the experiments and their evaluations. Partner organizations can select and conduct experiments and participate in experiments conducted by others, and they have access to all project results from past and ongoing efforts, which are available in reports and publications and a project-owned web-based database. Planning, steering, and financing is the responsibility of all partners participating in the experiment. (Larger field experiments are therefore often conducted by more than one organization.) Over the years, the organizations involved in the Mont Terri Project have provided substantial financial investments. Additional support has been contributed by the European Community and by the Swiss Federal Office for Science and Education. It is not surprising, therefore, that the Mont Terri Project has been very successful, and a wide range of experimental studies on clay/shale behavior (including backfill/buffer behavior) have been and are being conducted. The Mont Terri Project celebrated its 20th anniversary in 2016.

Table 3.1-1 Participation of International Programs in Cooperative Initiatives Related to URLs: Status September 2016.

Nuclear Nation	Organizations	DECOVALEX	Mont Terri	CFM	FEBEX-DP	SKB Task Forces
Belgium	SCK/CEN FANC		x x			
Canada	NWMO		x			x
China	CAS	x				
Czech Republic	SURAO	x			x	x
France	ANDRA IRSN	x	x x		x	
Finland	POSIVA			x	x	x
Germany	BGR GRS BMW/KIT	x	x x x	x	x	x x
Great Britain	RWM	x		x	x	x
Japan	JAEA CRIEPI Obayashi	x	x x x	x x	x	x x
Republic of Korea	KAERI	x		x	x	x
Spain	ENRESA CIEMAT		x		x x	
Sweden	SKB			x	x	x
Switzerland	NAGRA ENSI Swisstopo	x	x x x	x	x	x
United States	DOE NRC Chevron	x x	x x		x	x

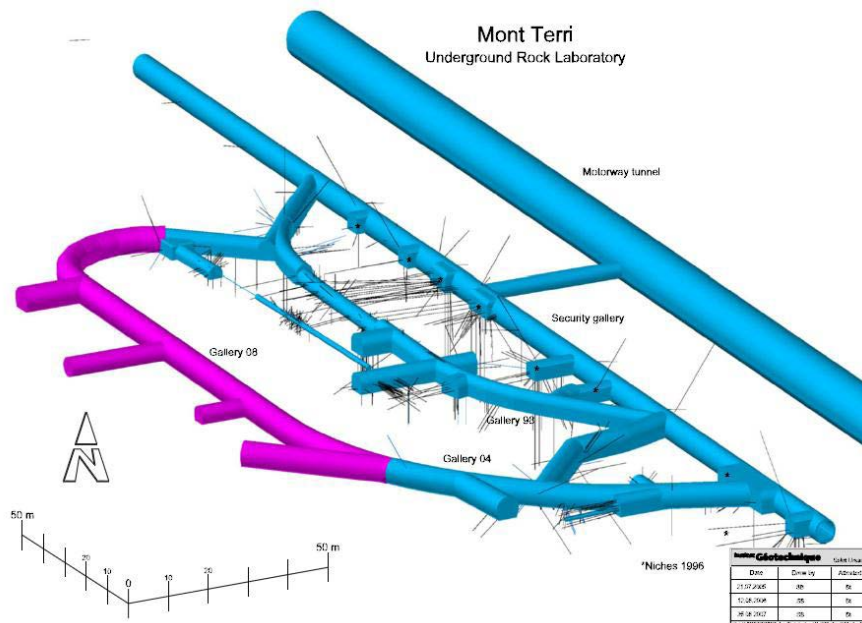

Figure 3.1-1 3D schematic of the Mont Terri URL with side galleries and drifts. Pink area shows access gallery drilled for Mine-by Test and FE Heater Test (from Bossart 2012).

DOE leadership recognized in 2011 that membership in the Mont Terri Project could be highly beneficial to UFD’s R&D mission, and decided in early 2012 to formally apply for membership. DOE’s partnership started officially with Phase 18 of the project, which ran from July 1, 2012 through June 30, 2013. Today, DOE is now one of 16 Mont Terri Project partners from eight countries, namely from Switzerland (Swisstopo, ENSI, NAGRA), Belgium (SCK/CEN, FANC), France (ANDRA, IRSN), Germany (BGR, GRS), Japan (OBAYASHI, JAEA, CRIEPI), Spain (ENRESA), Canada (NWMO), and the U.S. (Chevron, DOE). Participation in the project provides unlimited access to an operating underground rock laboratory in a claystone environment, with several past and ongoing experiments that are highly relevant to UFD’s R&D objectives. Membership has given UFD researchers with relevant field data and project results from all past Mont Terri phases. More importantly, UFD researchers have started working collaboratively with international scientists on selected ongoing and future experimental studies, which include all design, characterization, modeling, and interpretation aspects related to field experiments. DOE also has an opportunity to propose and eventually conduct its own experiments at the Mont Terri URL, which could be an option for project future phases.

Figures 3.1-2 and 3.1-3 show an overview of experiments currently conducted at the Mont Terri URL. The timeline in Figure 3.1-2 places these experiments in the context of relevance to different phases in the lifetime of a repository: (1) Experiments related to initial conditions and repository construction, (2) Experiments related to buffer emplacement and monitoring, (3) Experiments related to the transient post-closure phase of a repository, (4) Experiments related to the equilibrated post-closure phase of a repository, and (5) Experiments related to radionuclide transport. In terms of the experimental objective, one may distinguish three categories: (a) Experiments to provide a better understanding of performance-relevant processes during the lifetime of a generic clay repository (e.g., Excavation Damage Zone (or Excavation Disturbed Zone) (EDZ)), thermal effects, gas generation and transport, RN transport), (b) Experiments to better characterize the site-specific conditions at Mont Terri (e.g., host rock properties, *in situ* stresses, *in situ* geochemistry), and (c) Experiments testing and improving characterization and monitoring technologies.

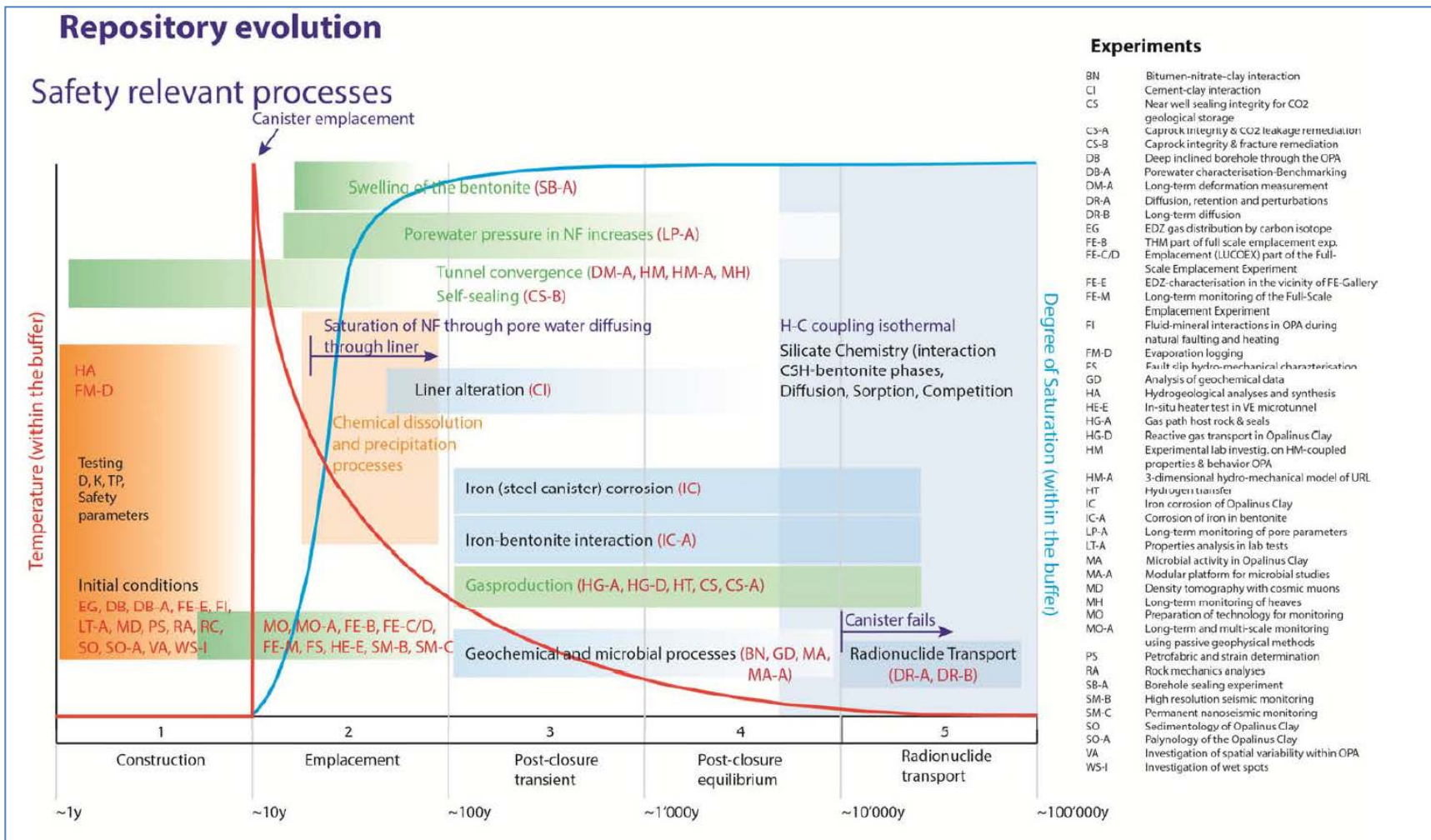

Figure 3.1-2 List of main Mont Terri URL experiments conducted during Phase 21 (July 2015 through June 2016), displayed with respect to relevancy during different repository stages (from Bossart 2015).

Key experiments

- BN Bitumen-nitrate-clay interaction
- CD Cyclic deformations
- CI Cement-clay interaction
- DB Deep inclined borehole through the Opalinus Clay
- DB-A Porewater characterisation-Benchmarking
- DI Diffusion in rock
- DI-A Long-term diffusion
- DI-B Long-term diffusion
- DM-B Long-term deformation measurements
- DR Diffusion and retention experiment
- DR-A Diffusion, retention and perturbations
- EB Engineered barriers
- EZ-B Fracture generation
- FE Full scale emplacement demonstration
- FI Fluid-mineral interactions in Opalinus Clay during natural faulting and heating
- FM-C Flow mechanism (traces)
- HE/HE-B Heater experiments I and II
- HE-D THM behaviour of host rock (heater test)
- HE-E In-situ heater test in VE microtunnel
- HG-A Gas path host rock & seals
- HM Experimental lab investig. on HM-coupled properties & behavior Opalinus Clay
- HT Hydrogen transfer
- IC Iron corrosion of Opalinus Clay
- IC-A Corrosion of iron in bentonite
- LP-A Long-term monitoring of parameters (porewater pressures)
- LT-A Clay properties, analyses of labtesting
- MA Microbial activity in Opalinus Clay
- MA-A Modular platform for microbial studies
- PC Porewater chemistry
- PC-C Gas porewater equilibrium
- PS Petrofabric and strain determination
- RC Rock mass characterisation
- SB Selfsealing barriers clay - sand mixtures
- SB-A Borehole sealing experiment
- SE-H Self-sealing with heat (Timodaz)
- SF Self-sealing of tectonic faults
- SM-B High resolution seismic monitoring
- SM-C Permanent nanoseismic monitoring
- SO Sedimentology of Opalinus Clay
- SO-A Palynology of the Opalinus Clay
- ST Seismic transmission measurements
- VE Ventilation test
- WS-A/E/H/I Porewater profiles, wet spots

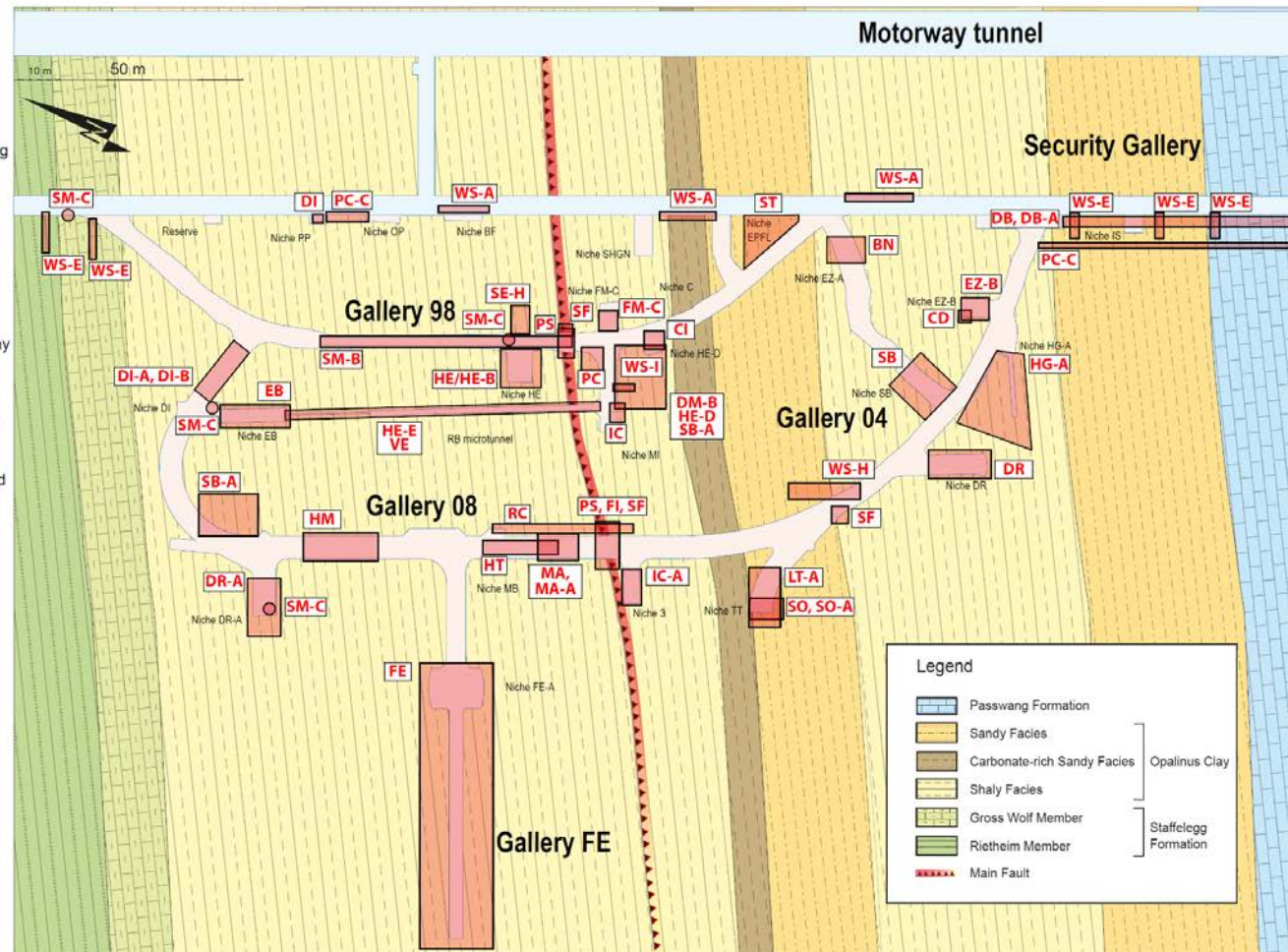

Figure 3.1-3 Plan view of the Mont Terri URL with key experiments. Gallery FE indicates the area of the FE Heater test, which is currently the largest subsurface heater experiment worldwide (Bossart 2016).

Many experiments shown in Figure 3.1-2 and 3.1-3 (Status January 2015, Phase 20) are long-running tests that have carried on into the ongoing Phase 20 of the Mont Terri Project, and that will continue into future project phases. While a few additional experiments have recently been initiated at Mont Terri that are relevant to other subsurface applications such as geologic carbon sequestration (i.e., CS-A Experiment: Well-leakage simulation & remediation experiment), the majority of activities continue to be related to geologic disposal of radioactive waste. Since 2012, DOE has engaged in several such experiments: the FE Heater Test, the HE-E (In Situ Heater Experiment in Micro-tunnel) Heater Test, the Engineered Barrier Experiment, the FS Fault Slip Experiment, the Mine-by Test, the HG-A (Gas Path through Host Rock and Seals Experiment) Experiment, and the DR-A Diffusion, Retention, and Perturbation Experiment. Some detail on those experiments that DOE is currently involved with is given in Sections 3.1.2 through 3.1.5 below, and summaries of UFD research activities related to these experiments are provided in Section 6. Almost all experiments include substantial laboratory and modeling tasks, in addition to the actual field components of the project.

It is worth describing how the collaborative Mont Terri project operates and how the process of planning and initiating new experiments works. Once a year, at the Technical Meeting held in late winter, partner organizations may propose in brief presentations any new work that they would like to undertake in the upcoming Mont Terri project phase(s) (as mentioned before, project phases always run from July 1st of one year through June 30th of the following year). The proposing partners will present the technical scope and merit of the proposed work and will give a rough estimate of the cost. Then, they will invite other partner organizations to consider joining the new task. In some cases, that could mean a direct financial contribution to the cost of the experiment, in other cases, they may invite partners to conduct monitoring or modeling analysis complementing their proposal. They will then write a short project description prior to the next Mont Terri Steering Committee Meeting (which is typically held a few months after the Technical Meeting) where ongoing and new experiments are selected. The experimental program for the next project phase is then finalized, including the financial contributions of each partner, in a second Steering Committee Meeting held just before the start of the new phase. This process is repeated every year.

For DOE, there is a clear path forward at Mont Terri, if, in the future, UFD had an interest in proposing its own experiments. Partners can be found if the proposed work aligns well with the interest of other Mont Terri organizations. It is important to note in this context that the existing infrastructure at Mont Terri makes developing and conducting experiments very easy, even if the proposing partner is located far away from the URL. Swisstopo can handle many of the organizational details, if needed, and there is a long list of experienced contractors available to conduct the actual experimental work. Furthermore, Swisstopo and its partners have now decided to build a significant extension of the underground research laboratory in the 2018-2020 timeframe, to provide additional working space for future large-scale experiments relating geologic disposal, but also to CO₂ sequestration and geothermal applications. As shown in Figure 3.1-4, the plan is to achieve extension of the URL via a tunnel loop excavated in a southwestward direction.

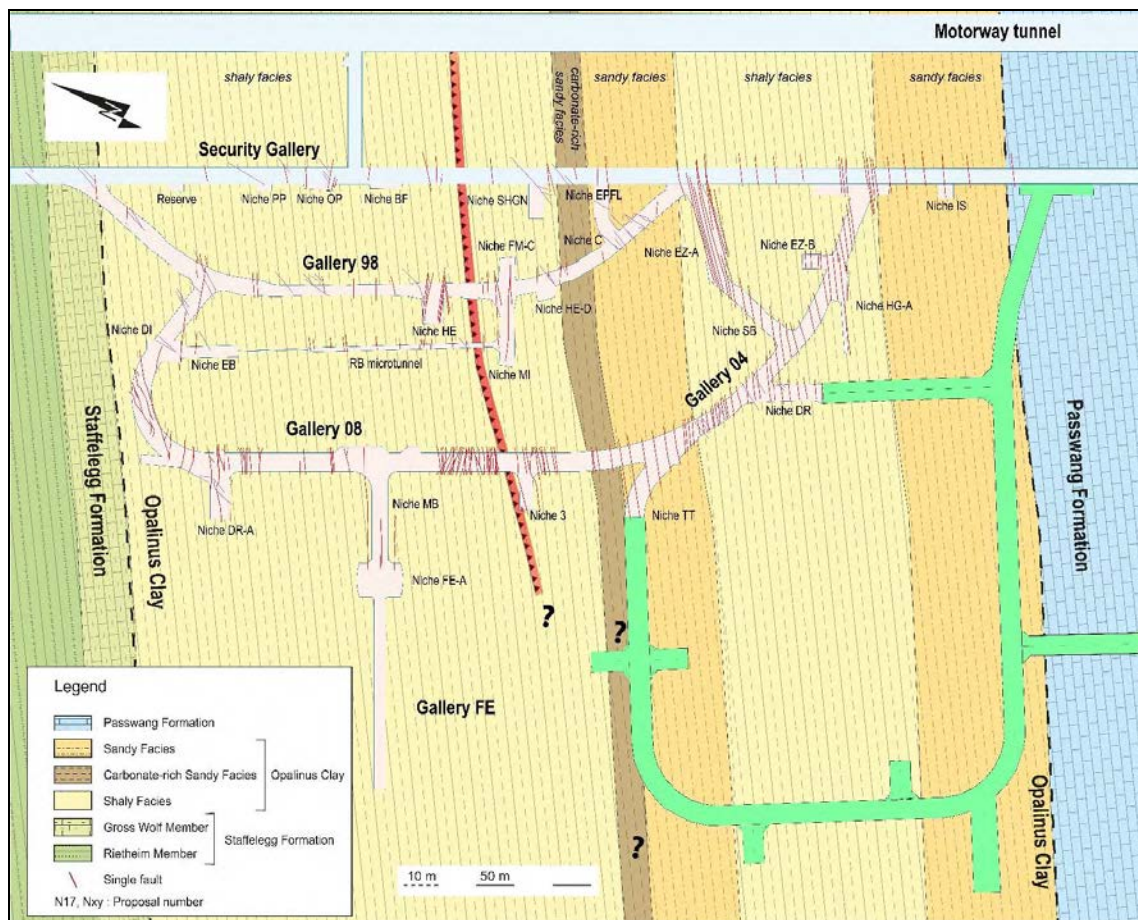

Figure 3.1-4 Plan view of the Mont Terri URL with potential extension in mostly southwestward direction (from Bossart 2016).

3.1.2 FE Heater Test

The Full-Scale Emplacement Experiment (FE Heater Test) is one of the largest and longest-duration subsurface heater tests ever conducted. This heater experiment has been designed by NAGRA as an ultimate test for the performance of geologic disposal in Opalinus Clay, with focus on both EBS components and host-rock behavior. Mont Terri partners collaborating with NAGRA in this experiment are ANDRA, BGR, GRS, NWMO, and, as of July 2012, also DOE. As shown in Figures 3.1-5 through 3.1-7, the FE Heater Test was conducted in a side niche and gallery at Mont Terri, excavated along the claystone bedding plane for this purpose, with 50 m length and about 2.8 m diameter. Heating from emplaced waste is simulated by three heat-producing canisters of 1500 W maximum power. A sophisticated monitoring program was planned and implemented, including dense pre-instrumentation of the site for *in situ* characterization, dense instrumentation of bentonite buffer and host rock, and extensive geophysical monitoring. A thermo-hydro-mechanical (THM) modeling program is conducted in parallel with the testing and monitoring activities.

After years of preparation and construction, all the heaters, the bentonite buffer, and instrumentation have now been installed, the tunnel has been plugged, and the final heater started operating on February 15, 2015 (Figure 3.1-8). During the preparation phase, predictive THM models of the anticipated FE Heater Test behavior had been developed by some project partners (among them UFD scientists from LBNL), for

the support of design and for instrumentation planning, as well as for later comparison of “blind predictions” with measured THM effects. In the final design, a staged heating approach was employed in which the three heaters were turned on in stages. This ensured that the models for predicting the maximum temperature in the buffer were validated against early temperature data before running all three heaters at the same time. UFD researchers and their international partners are currently working on the interpretative modeling of the first year and a half of THM monitoring data (Section 6.1.1.4).

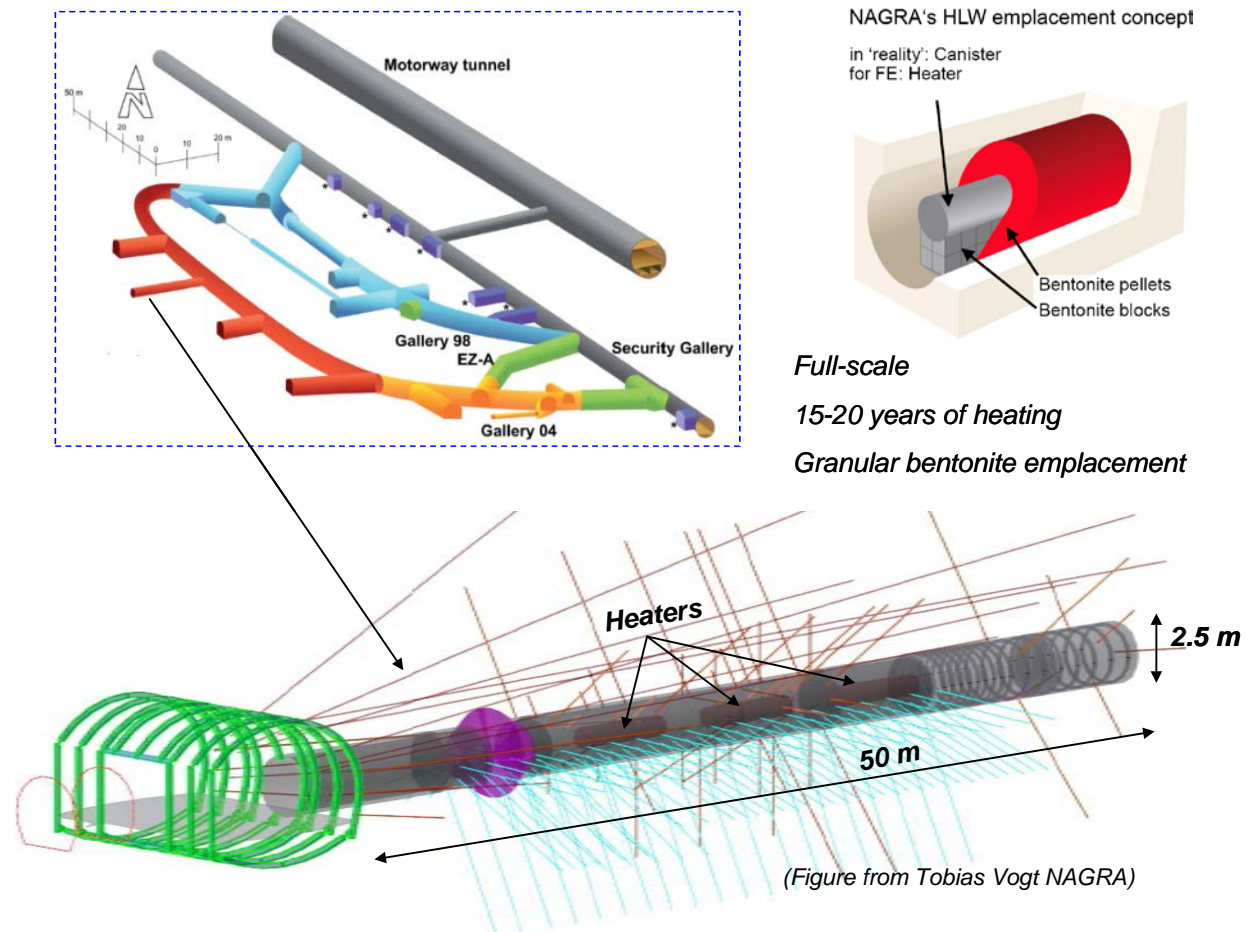

Figure 3.1-5 FE Heater Test at Mont Terri URL: experiment setup and borehole layout (from Zheng et al. 2015)

After 18 months of heating, the experiment has already started providing useful data for the validation of THM coupling effects regarding the processes in the host rock, while correctly accounting for (and examining) the expected conditions in the emplacement tunnel (temperature, saturation, and swelling pressure). Due to the 1:1 scale of the experiment, it is possible to achieve realistic temperature, saturation, and stress gradients. The experiment also allows the testing of backfilling technology with granular bentonite, as well as lining technology with shotcrete, anchors, and steel ribs. Processes examined in the test cover many aspects of repository evolution, such as EDZ creation and desaturation of the EDZ during tunnel excavation and operation (including ventilation for about one year), reconsolidation of the EDZ, resaturation, thermal stresses, and thermal pore-pressure increase after backfilling and heating (heating and monitoring period > 10 years).

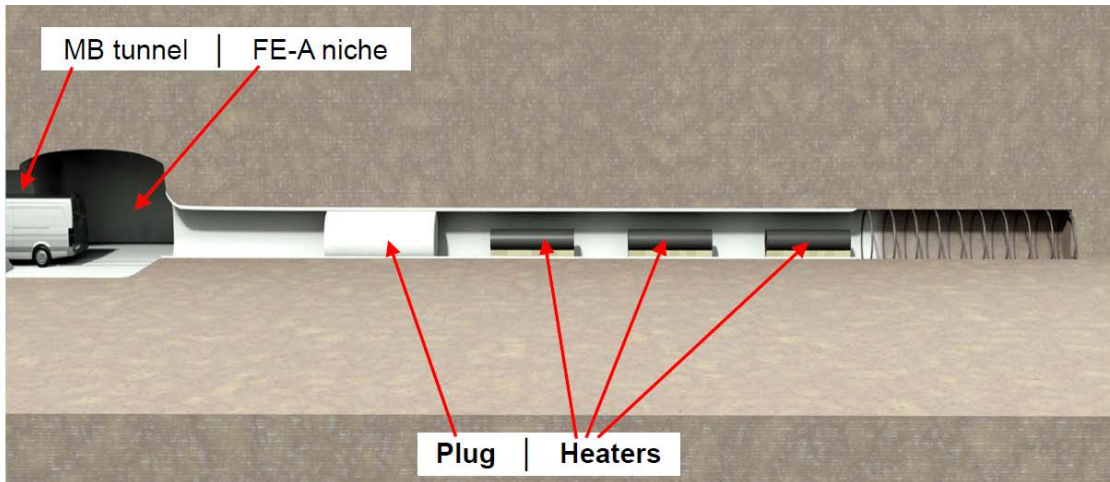

Figure 3.1-6 FE Heater Test at Mont Terri URL: Side view of experiment setup and heater layout (Garitte 2010).



Figure 3.1-7 View from the FE gallery into the heater tunnel during final installation (Bossart 2014a).

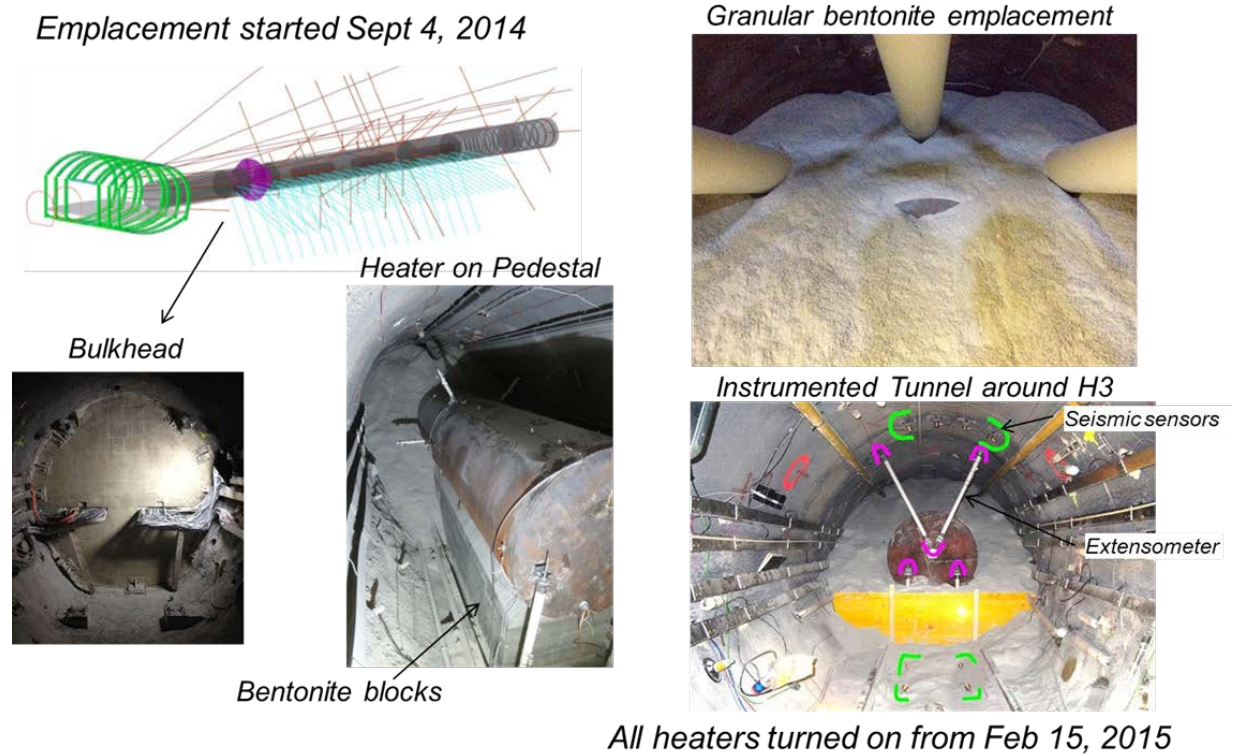

Figure 3.1-8 Images from the construction and installation of heaters, bentonite buffer and plugs (Zheng et al., 2016).

3.1.3 HE-E Heater Test

The HE-E Heater Test at the Mont Terri URL is an ongoing experiment conducted in a micro-tunnel at 1:2 scale (Figures 3.1-9 and 3.1-10). In contrast to the FE Heater Test, it is considered a process and model validation test, not a demonstration experiment. HE-E focuses on the THM behavior of bentonite barriers in the early nonisothermal resaturation stage and the THM interaction with Opalinus Clay, and assesses the performance of two types of bentonite buffer materials, one consisting of bentonite pellets, the other made of a bentonite-sand mixture. A dense instrumentation network that had already been in place in the host rock surrounding the micro-tunnel (from a previous experiment testing the impact of ventilation on the clay host rock) was amended (up to 40 piezometers in total); various sensors were also placed into the buffer material (Figure 3.1-11). Heating started in the summer of 2011 and has been continuously operating since. The heater-buffer interface is heated to a maximum of 140°C; the temperature at the buffer-rock interface is about 60–70°C (Figure 3.1-12). From 2012 through 2015, results from the HE-E Heater Test were used as a modeling task in the DECOVALEX 2015 project (see Section 3.2.2.2).

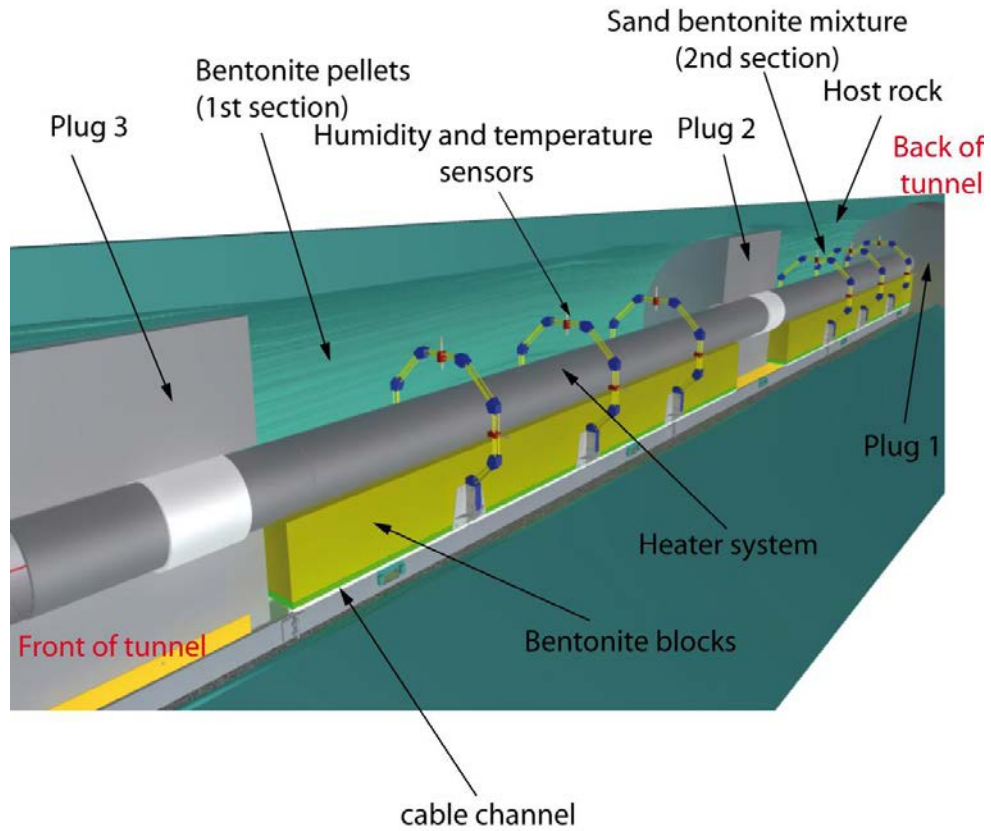

Figure 3.1-9 Schematic setup of HE-E Heater Test at Mont Terri URL (Garitte et al. 2011).



Figure 3.1-10 HE-E Heater Test at Mont Terri URL: Photo of micro-tunnel before buffer emplacement.

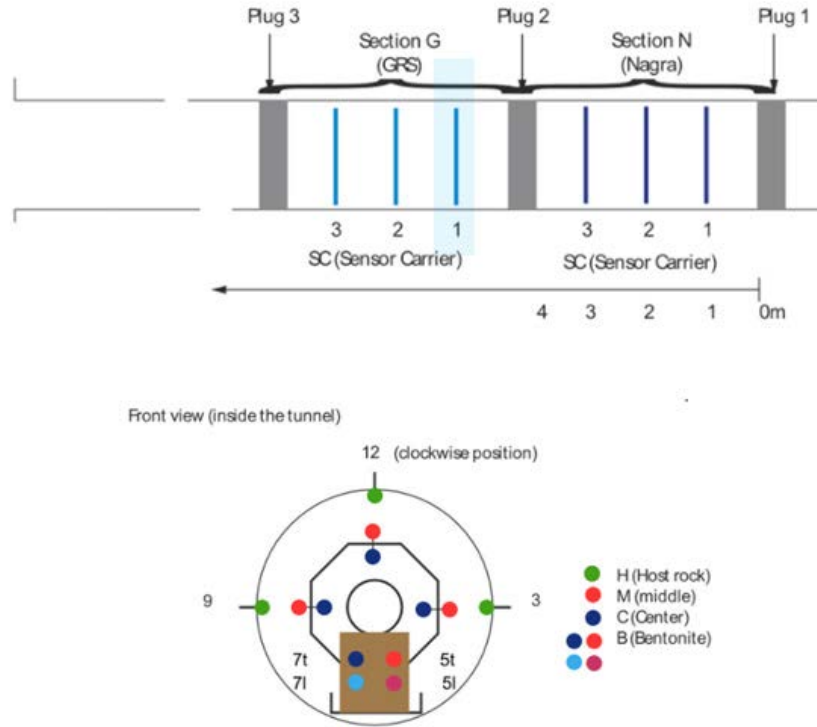

Figure 3.1-11 HE-E Heater Test at Mont Terri URL: Typical sensor placement (Gaus et al. 2014).

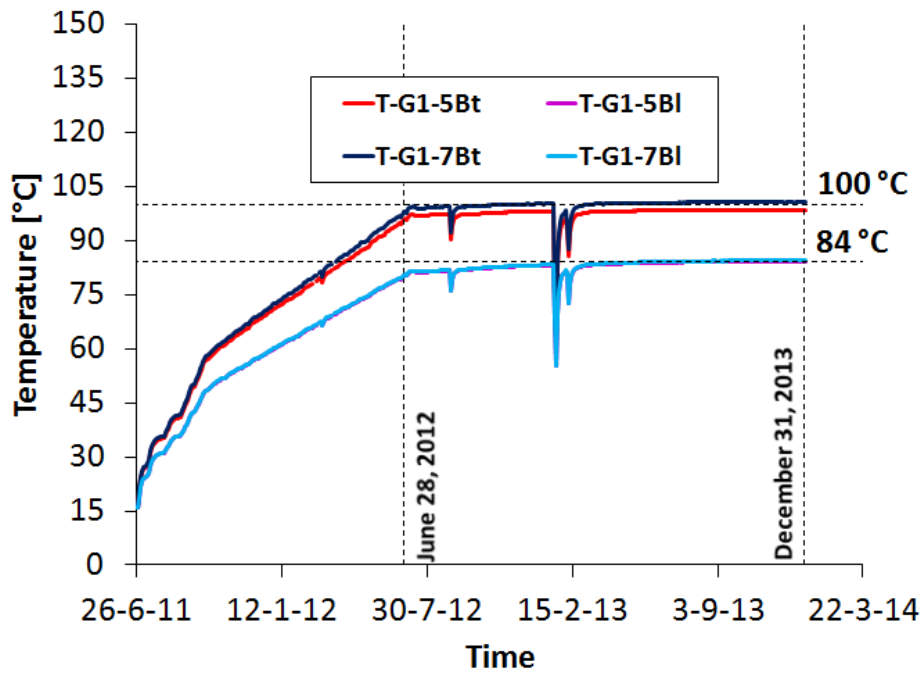

Figure 3.1-12 HE-E Heater Test at Mont Terri URL: Measured temperature inside compacted bentonite blocks near heater surface (Gaus et al. 2014).

3.1.4 Engineered Barrier Experiment

The Engineered Barrier Emplacement (EB) Experiment was a full-scale test that ran for about 11 years in the EB niche at Mont Terri, a 15 m long gallery excavated for this purpose, which is parallel to the security gallery of the motorway tunnel. The test was conducted to demonstrate an advanced concept for the construction of a clay-based buffer for emplacement in horizontal drifts. The concept was based on the combined use of a lower bed made of compacted bentonite blocks and an upper backfill made with a granular bentonite material (GBM) that can be blown in from some distance (see Figures 3.1-13 and 3.1-14). After emplacement of mockup canister and bentonite backfill in 2001, the experiment started with artificial water supply to enable faster hydration of the bentonite and to achieve full saturation at the end of the experiment. Sensors were emplaced to measure canister displacements, relative humidity in the buffer, pore pressures in the rock and total stress in the interfaces between canister/buffer and rock/buffer (Figure 3.1-15). Observations from the monitoring system are available for the full duration of the test up to practically full saturation, after about 11 years of hydration. Dismantling of the hydrated bentonite, which started in October 2012 and concluded in January 2013, provides a large amount of high quality data concerning the final state of the buffer (especially water content, density and degree of saturation, hydraulic conductivity). In addition, there is information on EDZ behavior before and after dismantling. Results from the EB experiment are now utilized as a modeling task for the DECOVALEX 2019 project (see Section 3.2.3.4).

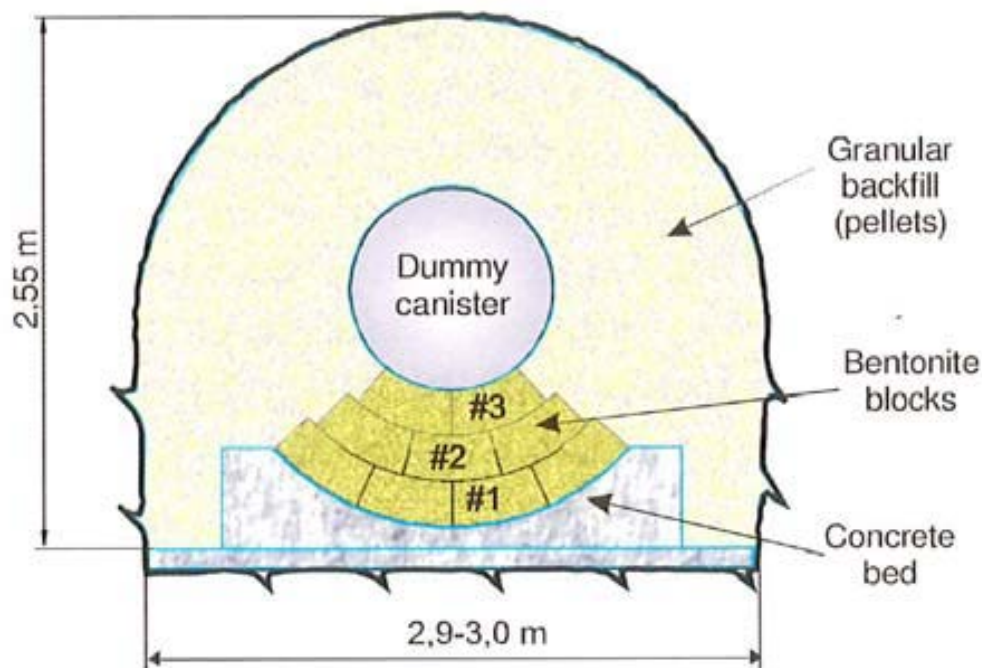

Figure 3.1-13 Experimental layout of the EB experiment (Gens 2016).



Figure 3.1-14 EB experiment in the construction phase: canister mockup placed on bentonite blocks and hydration pipes (Gens 2016).

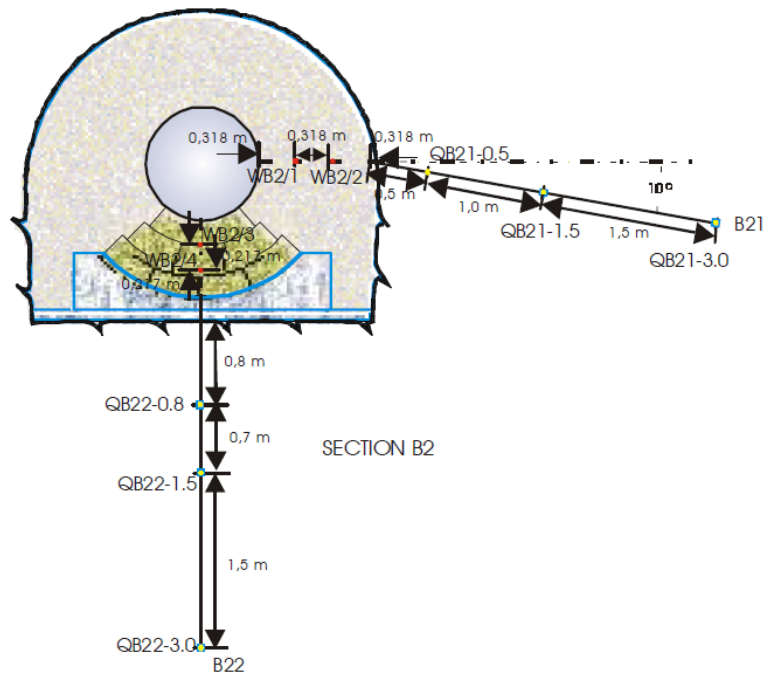

Figure 3.1-15 Positions of the 10 sensors in one vertical section of the EB Experiment: (1) relative humidity in buffer: WB21, WB22, WB23, WB24; and (2) pore pressure in rock: QB21_05, QB21_15, QB21_30, QB22_08, QB22_15, QB22_30 (Gens 2016).

3.1.5 FS Fault Slip Experiment

One of the more recent experiments at the Mont Terri URL is the Fault Slip (or FS) Test, which aims at understanding (i) the conditions for slip activation and stability of clay faults, and (ii) the evolution of the coupling between fault slip, pore pressure and fluids migration. Results obtained by the experiment (conducted in 2015) are crucial in defining mechanisms of natural and induced earthquakes, their precursors and risk assessment, but also the loss of integrity of natural low permeability barriers. Recent studies suggest that slow slip on faults may be a dominant deformation mechanism of shales during hydraulic stimulation or other large subsurface injection activities (Zoback et al. 2012). The same mechanism may be of importance in many other contexts where a stress perturbation is high enough to reactivate the faults, for example drilling a network of underground galleries for radioactive waste emplacement could activate slip on pre-existing faults and eventually enhance the formation permeability. Of similar concern to radioactive waste emplacement may be fault slip caused by pore pressure increase from the release of heat from the high-level waste or from the generation of gas due to steel corrosion. Hence, the possibility of an increased permeability caused by fault slip and generation of potential pathways in the host rock or in an upper sealing formation could be a major risk for the long-term safety of a repository.

The conditions for slip activation on clay faults are generally poorly understood, the clay content being suspected to constrain the slip stability and the type of seismicity that can be triggered. Field observations indicate that active faults can be hydraulically conductive even in low permeability clay dominated formations. Laboratory experiments on clay-rich samples generally conclude that for a given mean effective stress, shearing tends to reduce permeability (Zhang and Cox 2000). However, significant increases (a factor of 10-100) have been measured on silt/clay mixes sheared or failed under highly over consolidated conditions (Bolton et al. 1999), and similar increases have been observed in intermediate-scale experiments in two tunnel-based underground research facilities in France.

The key idea of the FS experiment at Mont Terri was to conduct controlled fault-slip experiments via localized pressurization in a packed-off section of a borehole drilled through the Mont Terri main fault zone (Figures 3.1-16 and 3.1-17). Water was injected between inflatable packers at increasing flow rates to progressively decrease the effective stress until fault destabilization occurs, while monitoring injection flow rate, pore pressure, fault slip and normal displacement evolution from the stable to the unstable fault states. Monitoring was performed with a new device called the High-Pulse Poroelasticity Protocol (HPPP) probe (Guglielmi et al. 2013a; b), which is capable of measuring slip velocities and slip deformation at unprecedented spatial resolution (Figure 3.1-18). The HPPP probe allows simultaneous high-frequency monitoring of full 3D-deformations of the borehole wall, fluid pressures, and injection flow rates within a 1.5 m long injection chamber set between two inflatable packers. The accuracy of measurements is very high, with 10^{-6} for deformations, 10^{-3} Pa for pressure, and 0.1 L/min for flow rate.

Two experimental test sequences using the HPPP probe in the main fault zone were conducted in 2015, one in May and one in September. Both test sequences involved injection into different test intervals in two separate boreholes (Figure 3.1-19). Prior to active testing, the detailed three-dimensional geology of the main fault was characterized and the regional state of stress was determined. The aim of the analysis was to estimate how the fault zone structural heterogeneity controls the fault slip activation and what would be the effect on pore pressures. Indeed, as shown in Figure 3.1-17, the Mont Terri fault displays a high structural heterogeneity characterized by solitary slickensides, mm-thin gouges associated with scaly clay having contrasted hydraulic and mechanical properties that can generate complex shear stresses concentrations and hydromechanical couplings (Figure 3.1-20).

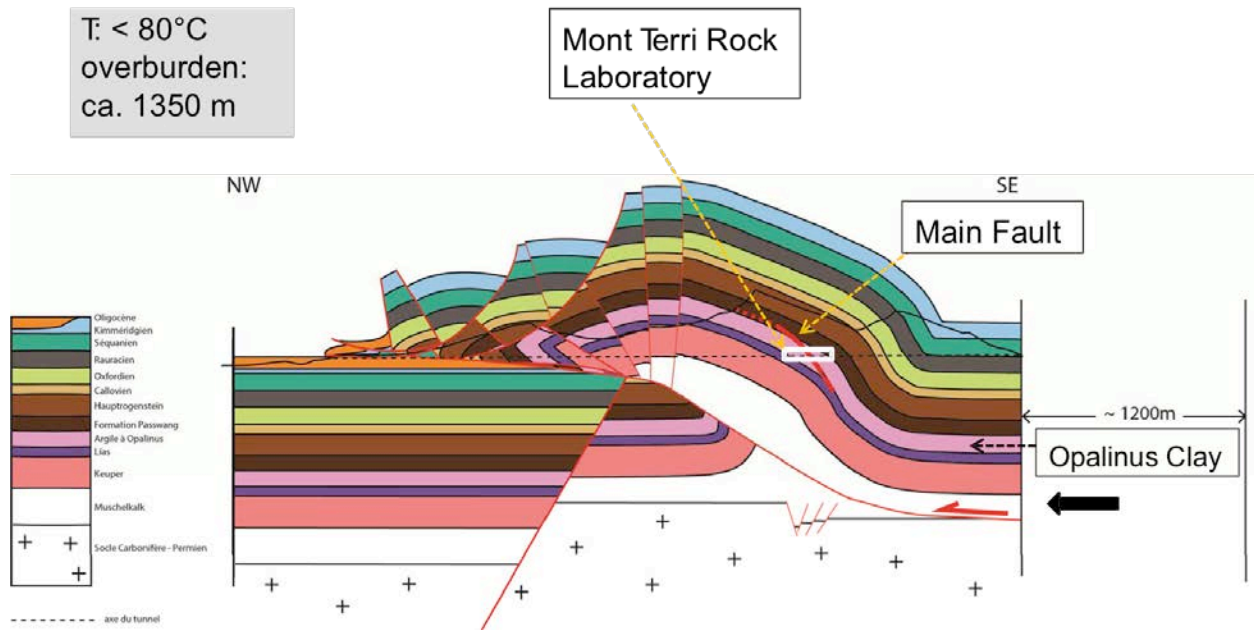

Figure 3.1-16 Geologic setting showing Mont Terri URL and location of main fault (Guglielmi et al. 2015).

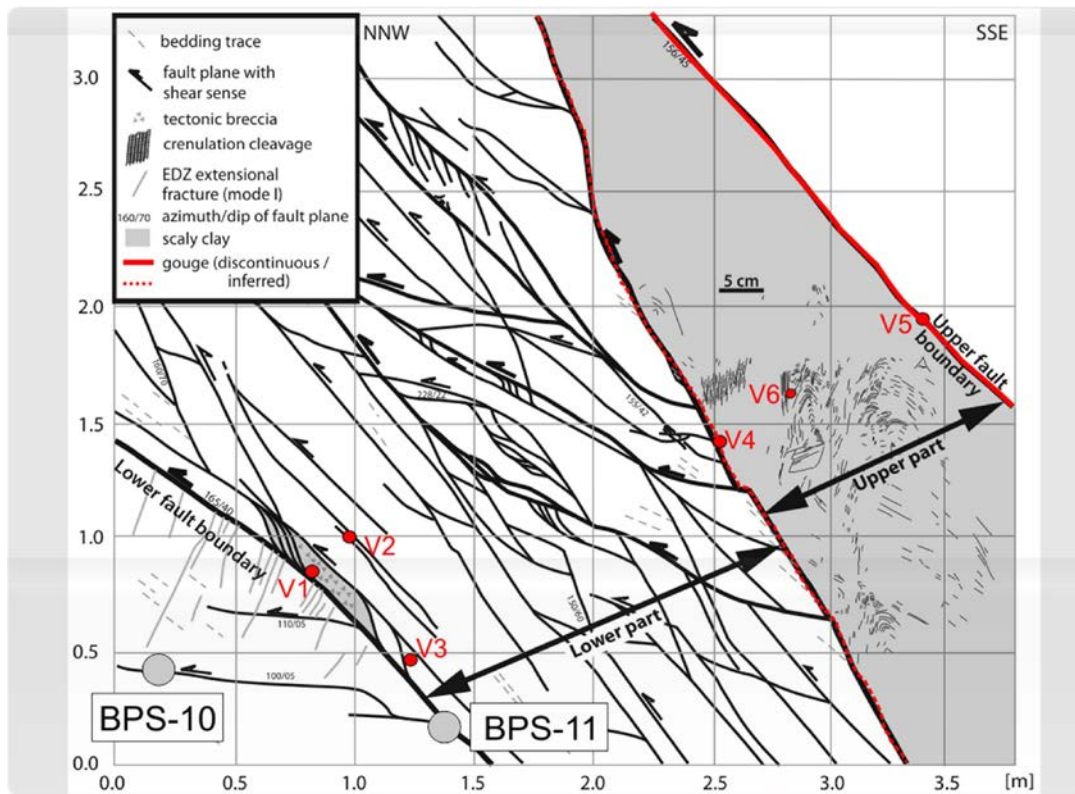

Figure 3.1-17 Detailed fault geometry at Mont Terri (Guglielmi et al. 2015).

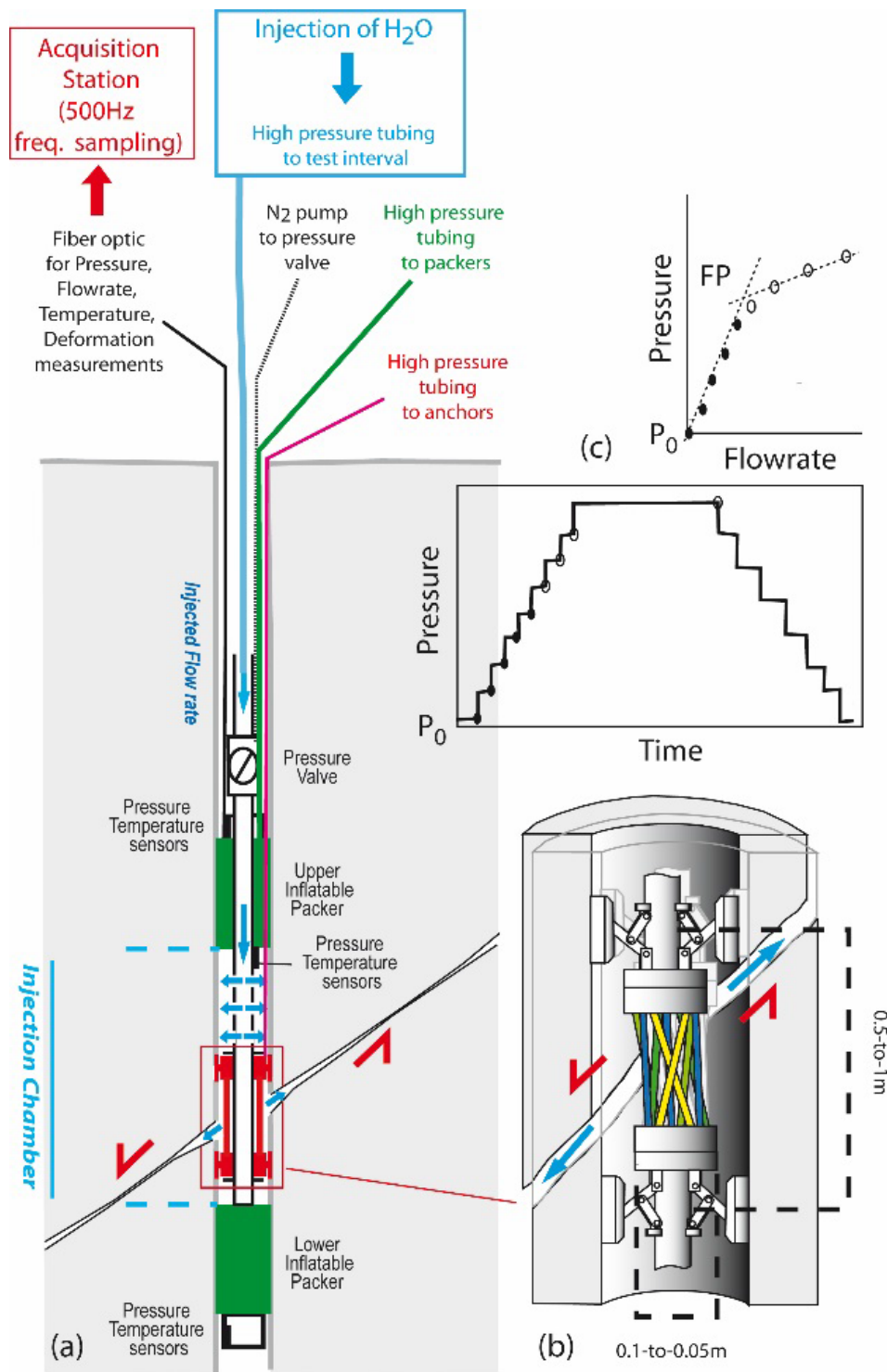

Figure 3.1-18 (a) Fault slip test equipment setup; (b) Schematic view of the three-dimensional deformation unit. Tubes are differently colored to show that they display different deformations when there is a relative movement of the rings anchored to the borehole wall across the activated fracture; (c) Typical Step-Rate Test protocol (Guglielmi 2016).

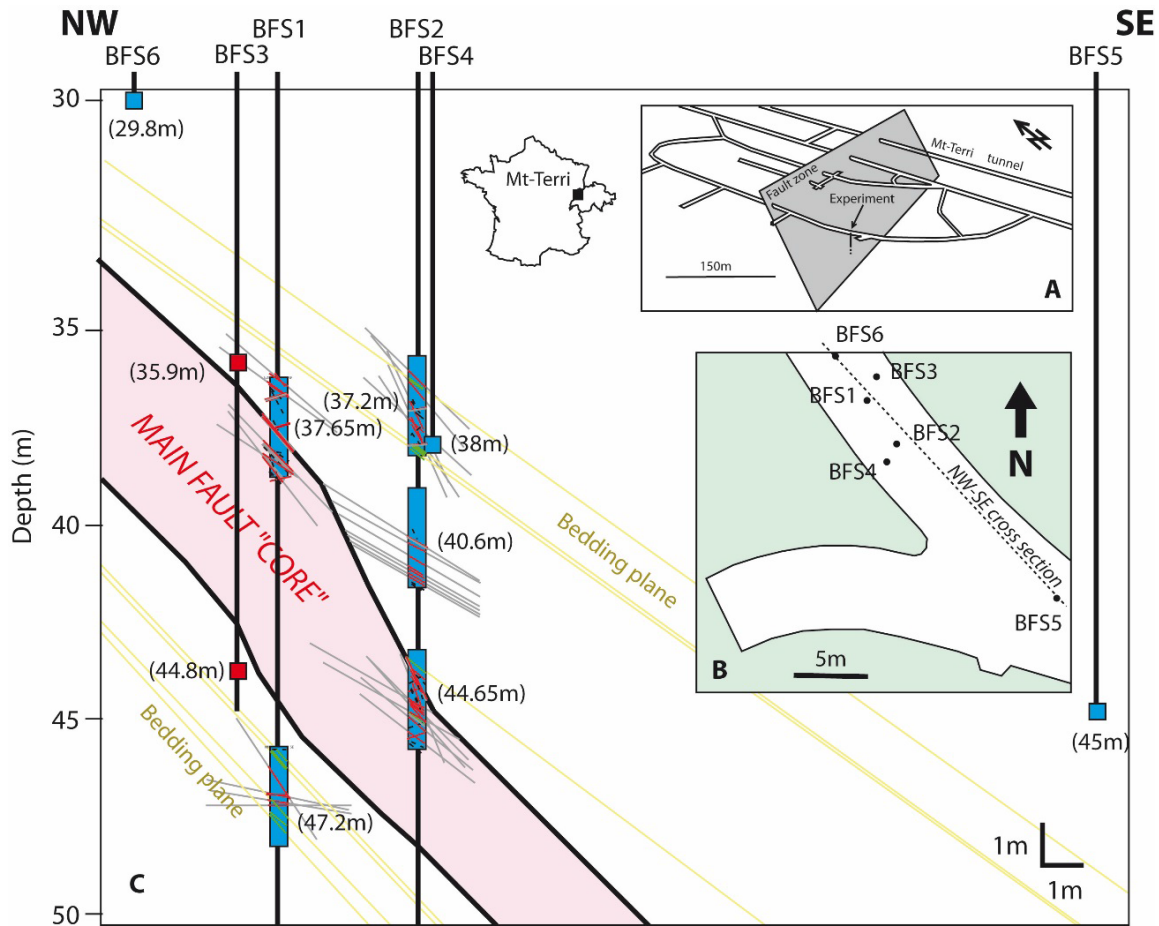

Figure 3.1-19 Test intervals across the Mt-Terri Main Fault (red squares are seismic sensors, blue squares are piezometers, blue rectangles are injection and monitoring intervals); A – Experiment location in Mt-Terri URL; B – Map of the boreholes geometry in the FS experiment zone and C – Cross section showing the different testing intervals in a simplified fault zone geology (Guglielmi 2016).

Figure 3.1-20 shows typical monitoring results from the Mont Terri controlled-release injection test, here depicted for four different borehole intervals. Three of the intervals in or near the fault damage zone are characterized by an initial pressure increase without significant flow followed by a sudden increase in the flow rate that occurs without any significant increase of pressure, indicating that the tested fault segment is opening to accept fluid (Fracture Opening Pressure – FOP). In contrast, no clear flow rate variation was observed in the fault core (Test 44.65m), (most of the flow rate transients seen in the figure are related to pumping artefacts), suggesting that different parts of the fault have different hydromechanical behavior. Note that results from these tests utilized as a modeling task for the DECOVALEX 2019 project (see Section 3.2.3.2).

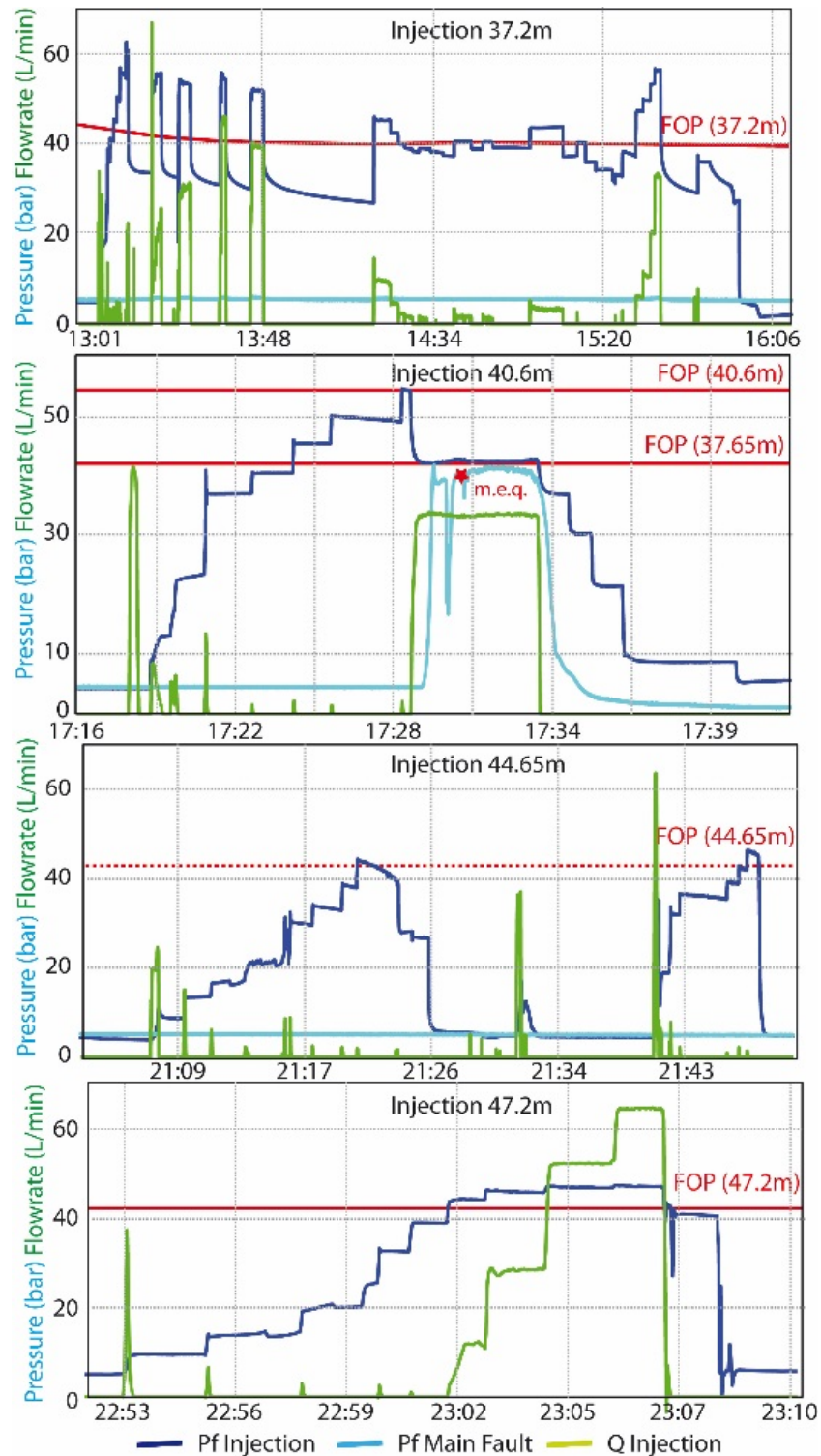

Figure 3.1-20 Pressure and injected flowrate variations monitored in four injection intervals and one monitoring borehole. Dark blue is pressure in the injection interval, light-blue is pressure in the monitoring interval, and green is injection flowrate, m.e.q. indicates micro-earthquakes triggered during injection test 40.6m (Guglielmi et al. 2016).

3.1.6 Mont Terri Summary

Benefits of Participation:

- Access to experimental data from one URL in clay/shale host rock, with many past, ongoing and future experiments addressing various FEPs
- Opportunity to participate directly in international research groups that conduct, analyze, and model experiments (more direct involvement than DECOVALEX)
- Opportunity for participating in and steering ongoing or planned experiments as well as conducting own experiments

Status of Participation:

Effective July 1, 2012, DOE formally joined the Mont Terri Project as a partner organization. A substantial part of DOE's partnership fee was provided as an in-kind contribution provided by DOE researchers (i.e., by having UFD researchers conduct work related to ongoing Mont Terri experiments). Specifically, the in-kind contribution of DOE included participation of LBNL researchers in the design and prediction modeling of the FE Heater Test. In addition to the FE Heater Test, UFD researchers have participated in the Mine-by Test, the HE-E Heater Test, the HG-A Experiment, and the DR-A Diffusion Experiment (Section 6), and, as part of DECOVALEX-2019, are currently participating in the collaborative modeling of the EB Experiment and the Fault Slip Test.

Outlook:

Ongoing participation of UFD researchers in the Mont Terri Project has been very beneficial. UFD researchers will continue to stay involved in relevant experiments, in particular in the long-term FE Heater Test, and they will keep abreast of new opportunities in the URL as they evolve. Eventually, DOE/UFD may propose its own experiments to be conducted at the site (e.g., a heater test to evaluate strongly elevated temperature in EBS and host rock for understanding direct disposal options for dual-purpose canisters). It has now been decided that the Mont Terri Project will build a significant extension of the underground research laboratory in the 2018-2020 timeframe, thus the long-term future of the collaboration project is ensured.

Contact Information:

DOE Contact:

Prasad Nair, DOE-NE (R&D)

UFD Contact:

Jens Birkholzer, LBNL

Mont Terri Project Contact:

Paul Bossart, Director, Swisstopo, Switzerland

Christophe Nussbaum, Project Manager, Swisstopo, Switzerland

3.2 DECOVALEX Project

3.2.1 Introduction to the DECOVALEX Project

The DECOVALEX Project is a multinational research collaboration for advancing the understanding and mathematical modeling of coupled thermo-hydro-mechanical (THM) and thermo-hydro-chemical (THC) processes in geologic and engineered systems associated with geologic disposal of radioactive waste. DECOVALEX is an acronym for “Development of Coupled Models and their Validation against Experiments.” Starting in 1992, the project has made important progress and played a key role in the development and validation of advanced numerical models. Through this project, in-depth knowledge has been gained of the complex THM and THC behavior of different host rock formations and buffer/backfill materials, and significant advances have been made in numerical simulation methods for their quantitative analysis. The knowledge accumulated from this project, in the form of a large number of research reports and international journal and conference papers in the open literature, has been applied effectively in the implementation and review of national radioactive-waste-management programs in the participating countries. The project has been conducted by research teams from a large number of radioactive-waste-management organizations and regulatory authorities, from countries such as Canada, China, Finland, France, Japan, Germany, Spain, Sweden, UK, Republic of Korea, Czech Republic, and the USA. A good overview of the project is provided on the DECOVALEX Project web site (www.decovalex.org) and given in Tsang et al. (2009).

The DECOVALEX Project has generally been conducted in separate four-year project phases. Each phase features a small number (typically three to six) of modeling tasks of importance to radioactive waste disposal. Modeling tasks can be either Test Cases (TC) or Benchmark Tests (BMT). TCs are laboratory and field experiments that have been conducted by one of the project partners and are then collectively studied and modeled by DECOVALEX participants. BMTs involve less complex modeling problems, often targeted at comparing specific solution methods or developing new constitutive relationships. Numerical modeling of TCs and BMTs, followed by comparative assessment of model results between international modeling teams, can assist both to interpret the test results and to test the models used. While code verification and benchmarking efforts have been undertaken elsewhere to test simulation codes, the model comparison conducted within the DECOVALEX framework is different, because (a) the modeling tasks are often actual laboratory and field experiments, and (b) DECOVALEX engages model comparison in a broad and comprehensive sense, including the modelers’ choice of interpretation of experimental data, boundary conditions, rock and fluid properties, etc., in addition to their choice of simulators. Over the years, a number of large-scale, multiyear field experiments have been studied within the project (e.g., the Kamaishi THM Experiment in Japan, the FEBEX heater test at Grimsel Test Site in Switzerland, and the Yucca Mountain Drift-Scale Heater Test). Thus, the project provides access to valuable technical data and expertise obtained by DECOVALEX partner organizations; this is particularly useful in disposal programs that are starting their research on certain disposal or repository environments and have no URLs. DECOVALEX has a modeling focus, but with a tight connection to experiments.

To participate in a given DECOVALEX phase, interested parties—such as waste management organizations or regulatory authorities—need to formally join the project and pay an annual fee that covers the cost of administrative and technical matters. In addition to this fee, participating (funding) organizations provide funding to their own research teams to work on some or all of the problems defined in the project phase. Representatives from the funding organizations form a Steering Committee that collectively directs all project activities.

DOE had been a DECOVALEX funding organization for several past project phases. In 2007, DOE decided to drop out due to the increasing focus on the license application for Yucca Mountain. When the radioactive waste disposal program shifted to other disposal options and geologic environments, a

renewed DOE engagement with DECOVALEX was suggested in 2011 (Birkholzer 2011) as a logical step for advancing collaborative research with international scientists. In 2011, DOE evaluated the benefits of joining the upcoming DECOVALEX phase for the years 2012 through 2015, referred to as DECOVALEX-2015. UFD leadership realized that a renewed DECOVALEX participation would provide UFD researchers access to relevant field data from international programs and would allow them to work collaboratively with international scientists on analyzing and modeling these data. More specifically, the modeling test cases and experimental data sets proposed for DECOVALEX-2015 were highly relevant to UFD's R&D objectives. A decision was made in early 2012 that DOE would formally join the DECOVALEX project as a funding organization, and UFD researchers over the past few years have been involved in two of the three main modeling tasks in the DECOVALEX-2015 phase, as described in Section 3.2.2 below. In 2016, DECOVALEX moved into a new project phase with new modeling tasks for the years 2016 through 2019, referred to as DECOVALEX-2019 (Section 3.2.3). DOE continues to be an official and active funding organization in the DECOVALEX project and in May 2016 hosted the kick-off workshop for DECOVALEX-2019 at LBNL. In addition, Jens Birkholzer from LBNL is now the Chairman of the DECOVALEX project. UFD researchers are planning to participate in several of the new tasks developed for DECOVALEX-2019.

3.2.2 Modeling Tasks for DECOVALEX-2015

This section gives an overview of the DECOVALEX-2015 phase, which ran from spring 2012 through the end of 2015. Three main modeling tasks were defined for DECOVALEX-2015, all of which involved using data from experiments conducted in URLs (Table 3.2-1):

- **Task A:**
SEALEX Experiment: A long-term test of the hydraulic (sealing) performance of a swelling bentonite core (5 m long) in a mini tunnel (60 cm diameter) at the Tournemire URL in France
- **Task B:**
B1) HE-E Heater Test: Studies of bentonite/rock interaction to evaluate sealing and clay barrier performance, in a micro-tunnel at the Mont Terri URL
B2) EBS Experiment: Studies of the Thermo-hydro-mechanical-chemical (THMC) behavior of the EBS under heating conditions in both the early resaturation and post-closure stages of the repository, in a vertical emplacement hole at the Horonobe URL
- **Task C:**
C1) THMC Modeling of Rock Fractures: Modeling of laboratory experiments on THMC impacts on fracture flow
C2) Bedrichov Tunnel Experiment: Interpretation of inflow patterns and tracer transport behavior in fractured granite

Of these modeling tasks, Tasks A, B1, and B2 were mostly relevant to the Argillite work package of UFD; both target the behavior of clay-based backfill and sealing materials in interaction with clay host rock, at ambient (Task A) and heated conditions (Tasks B1 and B2). Tasks C1 and C2, the THMC Modeling Study and the Bedrichov Tunnel Experiment, were mostly relevant to the Crystalline work package of UFD. A short overview of Tasks A, B1, B2, C1, and C2 is given below; much more detail can be found in the DECOVALEX-2015 final reports available at www.decovalex.org (Jing et al. 2016; Millard et al. 2016; Garitte 2016; Sugita et al. 2016; Bond 2016; Hokr et al. 2016). Findings and conclusion from DECOVALEX-2015 will also be published in a series of manuscripts submitted a DECOVALEX Special Issue in the Journal of Environmental Earth Sciences.

Table 3.2-1 Modeling Test Cases for DECOVALEX-2015 (from Jing and Hudson 2011).

	Task A	Task B		Task C	
Task No.		Task B1	Task B2	Task C1	Task C2
Task Title	SEALEX Experiment	HE-E Heater Test	EBS Experiment	THMC Fracture	Bedrichov Tunnel
Proponent	IRSN	NAGRA	JAEA	RWM	SURAO
Main topic	EBS & EBS-rock interaction	EBS & EBS-rock interaction	EBS & EBS-rock interaction	NBS, Fundamental study on flow & transport	NBS, Flow & transport in fractured crystalline rocks
Relevance to repository development	Excavation, sealing & post-closure	Sealing & post-closure	Excavation, sealing & post-closure	Site characterization through to safety assessment	Site characterization and safety assessment
Processes	HMC	THM	THMC	THMC	HMC
Test time	2011–2015+	2011–2015 and beyond	2014–2015+	Data obtained, published data & literature support	Basic characterization completed, tracer tests planned
Host rock	Clay	Clay	Sedimentary rock	Granite and other hard rocks	Granite
Test site	Tournemire, France	Mont Terri, Switzerland	Horonobe, Japan	Laboratory tests	Czech Republic
Relevance to other rock types	Argillaceous but applies to all types of host rocks using EBS	Argillaceous but applies to all types of host rocks using EBS	Sedimentary but applies to all types of host rocks using EBS	Applies to all types of host rocks	Specific to crystalline but principles can be applied to other rocks
BMT or TC	TC	TC	TC	BMT	BMT/TC
Impact on PA/SA	Important for EBS, PA & total system SA	Important for EBS PA & total system SA	Important for EBS PA & total system SA	Important for scientific basis of radioactive waste disposal	Important for site characterization and total system SA
Group leader	IRSN	NAGRA	JAEA	NDA	SURAO

Ten funding organizations joined DECOVALEX-2015 as follows:

BGR/UFZ	Federal Inst. for Geosciences & Natural Resources (BGR) and Umweltforschungszentrum Leipzig-Halle (UFZ)	Germany
CAS	Chinese Academy of Sciences	China
DOE	Department of Energy	United States
ENSI	Swiss Federal Nuclear Safety Inspectorate	Switzerland
IRSN	Inst. for Radiological Protection & Nuclear Safety	France
JAEA	Japan Atomic Energy Agency	Japan
KAERI	Korean Atomic Energy Research Institute:	Korea
NRC	Nuclear Regulatory Commission	United States
RWM	Radioactive Waste Management Limited	Great Britain
SURAO	Radioactive Waste Repository Authority	Czech Republic

These organizations were participating in the three modeling tasks as follows:

- Task A: IRSN, RWM, NRC, SURAO
- Task B: BGR/UFZ, CAS, DOE, ENSI, JAEA, KAERI, NRC
- Task C: CAS, DOE, RWM, NRC, SURAO

Since each modeling task was investigated by four or more modeling groups, in-depth collaboration and model comparison between several international research teams was ensured.

3.2.2.1 Task A: SEALEX Experiment at the Tournemire URL

The SEALEX experiment aimed at investigating the long-term Hydro-mechanical (HM) behavior and hydraulic performance of swelling clay-based seals (Figure 3.2-1). A suite of experiments was conducted in several 60 cm diameter mini-tunnels (5 m long) (Figures 3.2-2 and 3.2-3), exposed to nominal conditions, different technological choices for seal mixtures (e.g., bentonite-sand mixtures) and emplacement, and altered situations (e.g., forced resaturation or not, loss of mechanical confinement or not) (Figure 3.2-4). Forced resaturation can lead to heterogeneous saturation and porosity/permeability fields within the bentonite-sand core, and hence may trigger clay-core erosion due to flow channeling. The experiments tested these hydraulic parameters and their spatial distribution via state-of-the-art measurement technology (e.g., wireless sensors installed within the core to limit preferential flow along cables). Hydraulic tests (pulse tests and constant load tests) were conducted to determine the overall hydraulic properties (permeability, leaks) of the seals, for different representative conditions.

The SEALEX experimental site is located in the Tournemire URL in the south of France. This URL is characterized by a subhorizontal indurated argillaceous claystone layer 250 m thick. The URL utilizes a two km long former railway tunnel, constructed in 1881 through the argillaceous formation. In 1996 and 2003, additional research tunnels were excavated off the main railway tunnel. This facility allows study of near-field rock behavior in indurated clay with different time periods of exposure to the atmosphere, namely 130, 15, and 8 years, respectively (Rejeb and Cabrera 2006) (Figure 3.2-5). The main objective of the SEALEX *in situ* tests was to evaluate the long-term hydraulic performance of swelling seal cores. Relevant scientific issues considered are:

- Investigation of hydraulic and mechanical processes such as evolution of excavation damage zone (EDZ), hydraulic performance of seals, and processes at bentonite-rock interfaces
- Investigation of the hydraulic performance of the seal-rock interface, including forced saturation effects, seal core swelling, sealing performance of the bentonite-rock interfaces

- Investigation of the generation of gas

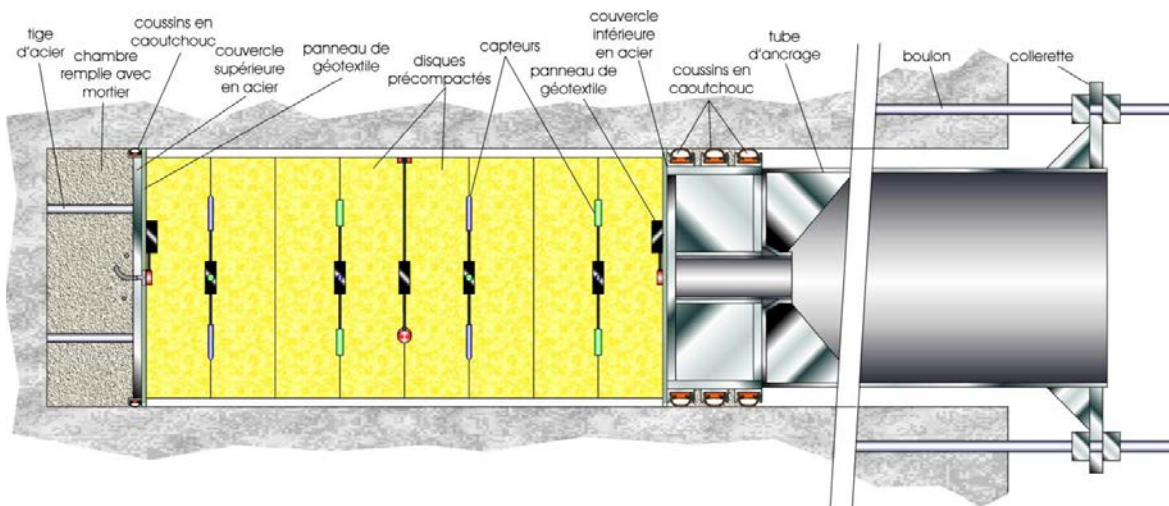

Figure 3.2-1. SEALEX Experiment at the Tournemire URL: Schematic setup of mini-tunnel with seal core and instrumentation (Barnichon and Millard 2012).

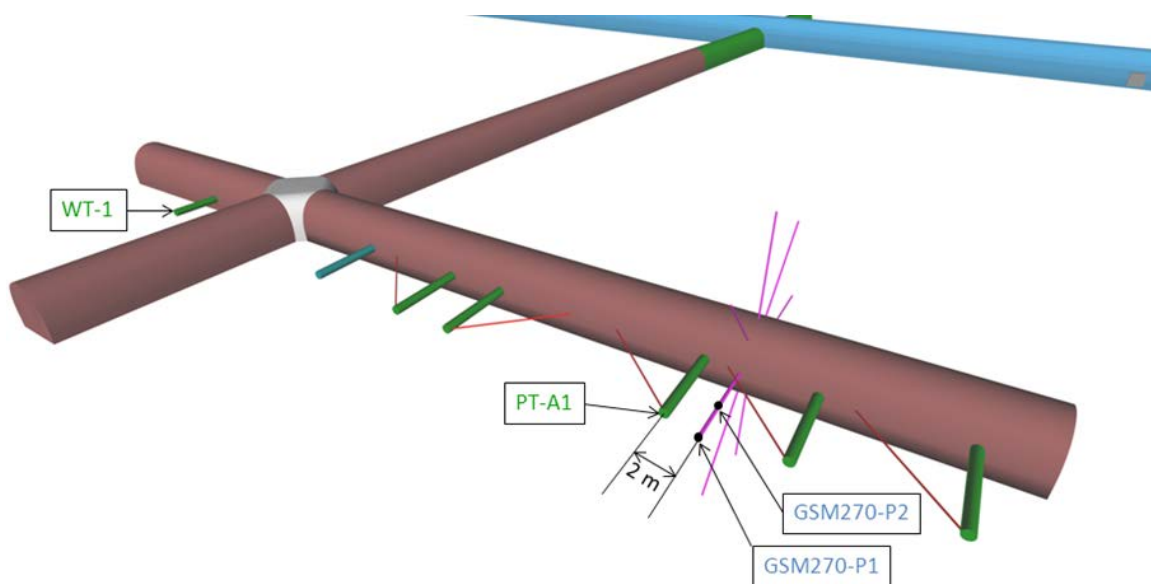

Figure 3.2-2. SEALEX Experiment at the Tournemire URL: Layout of mini-tunnels, access tunnels, and main gallery (Millard and Barnichon 2014).



Figure 3.2-3 SEALEX Experiment at the Tournemire URL: View of mini-tunnel from gallery after seal emplacement (Barnichon 2011).

	Reference Tests	Performance Tests	Intra-core geometry Core conditioning Composition (MX80/sand)	Core view	Altered conditions	Emplacement date
Base case	RT-1	PT-N1	Monolithic disks Precompacted (70/30)		No	12/2010 06/2011
Variations / Base case	-	PT-A1	Monolithic disks Precompacted (70/30)		Confinement loss	06/2012
	-	PT-N2	Disks + internal joints (4/4) Precompacted (70/30)		No	12/2011
	RT-2	PT-N3	Pellets/powder In situ compacted (100/0)		No	12/2012 06/2013
	-	PT-N4	Monolithic disks Precompacted (20/80)		No	12/2013

Figure 3.2-4 SEALEX Experiment at the Tournemire URL: Planned experiments and schedule (Barnichon 2011).

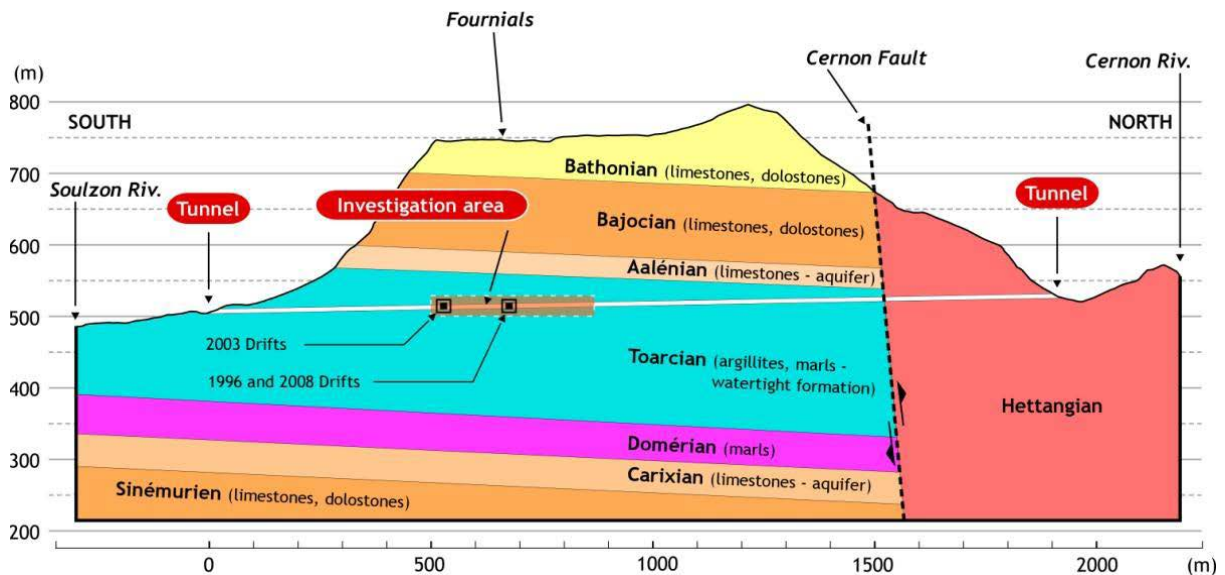

Figure 3.2-5 Geologic cross section of the Tournemire URL (Barnichon 2011).

The SEALEX test program was divided into reference tests and performance tests. The reference tests were performed mainly for quantifying the coupled hydro-mechanical fields inside the seal cores, characterized by stress, swelling pressure, pore pressure, and relative humidity, measured by high quality intracore wireless instrumentation. The performance tests considered mainly hydraulic tests (pulse tests and constant pressure tests) to determine the overall permeability fields and leaking of the seal cores, under alternative testing and core representation conditions. A progressive parametric testing approach was designed to perform the reference and performance tests with alternative bentonite core characteristics, instrument designs, and installation conditions of the cores. For Task A of the DECOVALEX-2015 project, the participating research teams performed numerical simulations of the saturation phase of the SEALEX experiments and investigated the coupled hydro-mechanical behavior of the seal/rock interfaces and intracore (rock) regions.

The modeling plan for Task A started with simpler models for the investigation of seal hydration behavior from laboratory experiments, followed by modeling of a 1/10 scale generic mock-up reproduction of the SEALEX experiment without rock-mass interaction, followed by simulating an *in situ* experiment testing the behavior of the rock-mass surrounding the test site, and finally the most complex modeling step targeted at fully understanding the HM behavior of a selected *in situ* performance test. To this end, four successive modeling steps were being conducted:

- Step 0: Modeling of bentonite-sand mixture hydro-mechanical behavior and parameter identification from various laboratory tests
- Step 1: Hydro-mechanical modeling of a 1/10 scale mock-up of the SEALEX experiment
- Step 2: Modeling of hydraulic behavior of the rock surrounding an experiment
- Step 3: Hydro-mechanical modeling of an *in situ* performance test

UFD researchers were not involved in Task A. More detail on Task A can be found in the DECOVALEX-2015 final report (Millard et al. 2016) available at www.decovallex.org.

3.2.2.2 Task B1: HE-E Heater Test at Mont Terri URL

Task B1 of DECOVALEX-2015 centered on the ongoing HE-E Heater Test at Mont Terri, which is described in Section 3.1.3 above. The main scientific issues considered in Task B1 were the thermal evolution, buffer resaturation (including *in situ* determination of the thermal conductivity of bentonite and its dependency on saturation), the evolution of pore-water pressure in the near field, the evolution of swelling pressures in the buffer, and the magnitude of water exchange between the EBS and the surrounding clay rock. The organizers of Task B1 designed a modeling plan with increasingly complex modeling steps as listed below. Instead of starting directly with the HE-E experiment, modeling teams initially focused on two preparatory modeling steps that looked separately at the THM response in clay host rock and bentonite respectively. Once this was achieved, modeling teams were asked to move to the HE-E experiment to test the THM behavior of bentonite barriers *and* the THM interaction with Opalinus Clay. The modeling plan for Task B1 included the following steps:

- Step 1a: Opalinus Clay study including HE-D experiment, literature study, process understanding, and parameter determination.
- Step 1b: Buffer material study including column cells, literature study, process understanding, and parameter determination.
- Step 2: HE-E predictive modeling using as-built characteristics and true power load.
- Step 3: 3D HE-E interpretative modeling when monitoring data were made available.

UFD researchers from LBNL participated as DOE's modeling team in this task (Section 6.1.1.2). More detail on Task B1 can be found in the DECOVALEX-2015 final report (Garitte 2016) available at www.decovallex.org.

3.2.2.3 Task B2: EBS Experiment at Horonobe URL

The ongoing EBS Experiment at the Horonobe URL investigates the THMC behavior of the EBS under heating conditions in both the early resaturation and post-closure stage of the repository and its interaction with the host rock. The scientific issues tackled in Task B2 included thermal evolution, buffer (bentonite) resaturation processes, backfill effects, pore-water pressure evolution in the near-field, swelling pressure evolution of the bentonite, water input from rock to EBS (involving characterization of rock saturation surrounding the EBS), and possible chemical issues, with model development, validation, and confidence building as one of the major objectives. The schedule of the experimental work in Task B2, with a heater start in January 2015, made it possible to adopt a blind prediction and validation approach. Modeling teams were asked to conduct a first set of simulations before obtaining data from the EBS experiment.

The EBS Experiment is being carried out at a depth of 350 m in sedimentary rock in the Horonobe URL (Figure 3.2-6). Figure 3.2-7 shows the experimental layout with a vertical heater emplacement installed in a test pit at the bottom of an experimental drift. The experimental drift was backfilled after the installation of the heater and bentonite buffer into the test pit. Backfill and buffer materials were based on the Japanese Kunigel V1 bentonite. Over one hundred sensors were placed in the buffer, backfill, and surrounding rock mass to monitor the coupled THMC processes, including temperature, pH, lithostatic and pore pressure, water content, resistivity, displacement, and strain (Figure 3.2-8). The exact sensor layout was decided upon based on initial model predictions made by the DECOVALEX teams.

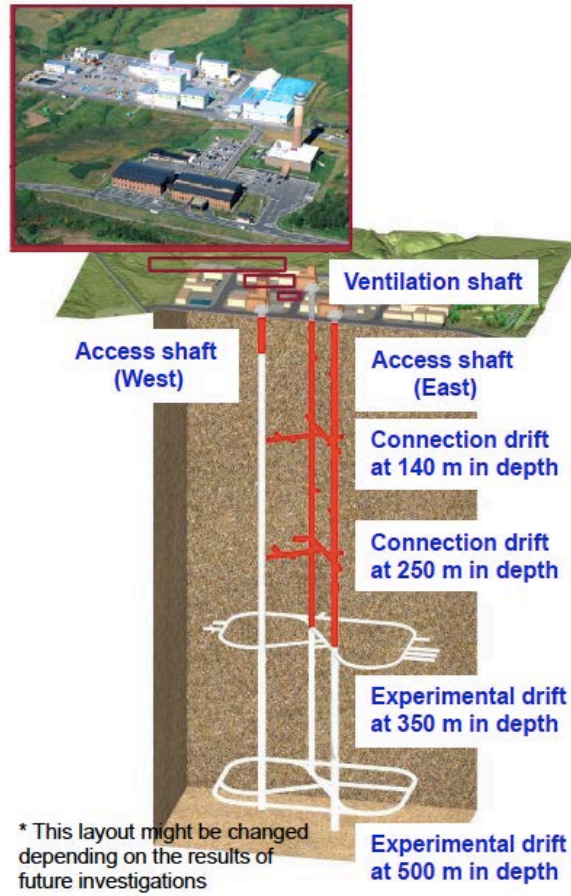

Figure 3.2-6 Design of Horonobe URL (Sugita and Nakama 2012).

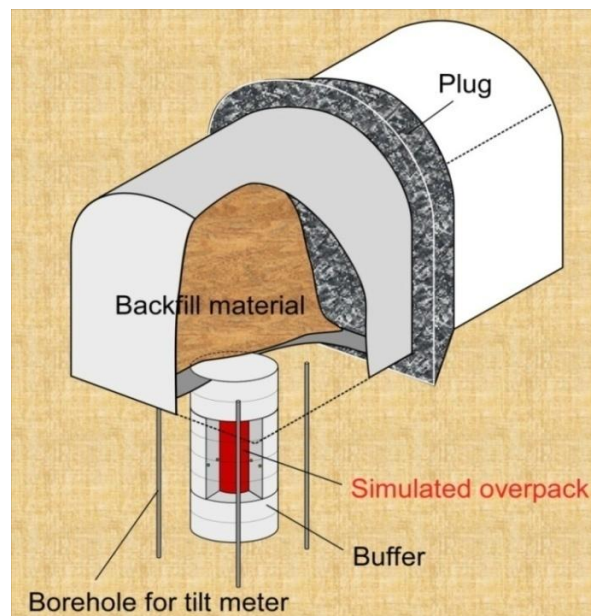

Figure 3.2-7 Design of EBS Experiment at Horonobe URL (Sugita and Nakama 2012).

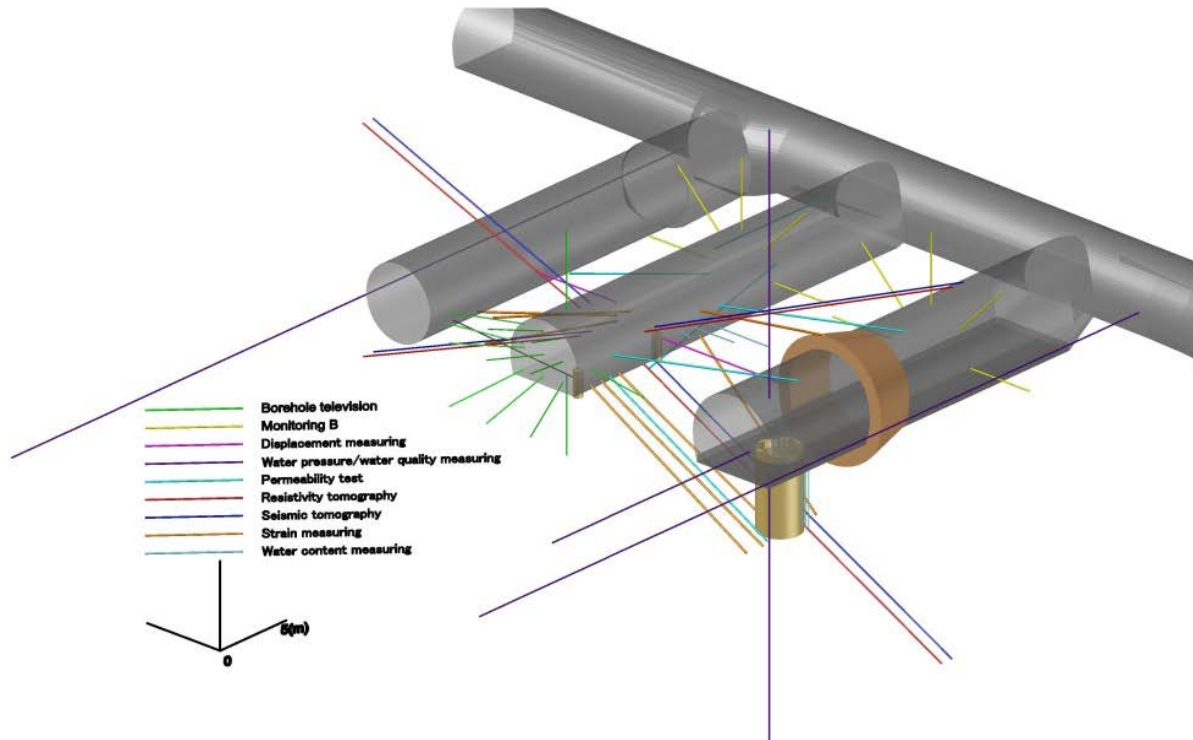

Figure 3.2-8 EBS Experiment: design of monitoring boreholes for sensor installation (from DECOVALEX web site, www.decovallex.org).

The modeling steps related to Task B2, the Horonobe EBS experiment, were defined as follows:

- Step 1: 1D benchmark test designed for validation of the numerical models
- Step 2: Prediction analysis and proposal of the sensor layout
- Step 3: Calibration analysis once experimental data became available

The 1D benchmark test (Step 1) was designed to take into account the host rock properties and boundary conditions given by the JAEA. [This modeling exercise was conducted so that modeling teams could familiarize themselves with the problem before going into the more complex full-scale case.] In Step 2, modeling teams were asked to construct a model of the real experiment and to conduct a first set of predictive THM simulations. As mentioned, these results were used to guide the installation of sensors, which began in the spring of 2014. In the last year of DECOVALEX-2015, JAEA provided to the research teams an initial set of monitoring data for the first months after heating started, to allow for model comparison with an initial data set and model calibration. UFD researchers from LBNL participated as DOE's modeling team in this task (Section 6.1.1.3). More detail on Task B2 can be found in the DECOVALEX-2015 final report (Sugita et al. 2016) available at www.decovallex.org.

3.2.2.4 Task C1: THMC Processes in Single Fractures

Many of the proposed sites for nuclear waste repositories are naturally fractured, and the macroscopic permeability is controlled by the transmissivity of the individual fractures. These may be altered by the dissolution and precipitation of minerals, a process strongly influenced by temperature, and by the stresses acting within the asperities the fractures. This process constitutes a truly thermo-hydro-mechanical-chemical (THMC) coupled system.

Task C1 used data from single-fracture-flow laboratory experiments to model such THMC processes, in particular looking at the linkage of thermal stresses mediating chemical effects, and conversely of chemical potentials mediating mechanical behavior (e.g., pressure solution), and how any of these processes affect flow behavior. This task involved fully coupled THMC model capabilities, which only recently have become available and still require thorough validation. Early laboratory experiments available to target such THMC behavior were conducted on single rock fractures in novaculite (a form of microcrystalline or cryptocrystalline quartz) (Figure 3.2-9) (Yasuhara et al. 2004; 2006). These experiments involved reactive flow-through compression and shear tests conducted on single natural-fracture specimens under different temperature, stress, and chemical conditions. The experiments were constrained by concurrent monitoring of stress/strain, influent and effluent flows/chemical reactants, and by intermittent nondestructive imaging by x-ray computer tomography. More recently, similar experiments have been conducted on granite (Yasuhara et al. 2011). The data sets from these experiments can be used for validation of THMC models with direct chemical-mechanical coupling between chemical reaction and strain.

Task C1 aimed at modeling, in a fully coupled manner, the THMC processes in rock fractures based on the two sets of experiments described by Yasuhara et al. (2006) and Yasuhara et al. (2011), which exhibit coupled THMC responses in single artificial fractures in novaculite (quartzite) and granite, respectively. The ultimate objective was to investigate, develop, and test robust process models for the representation of coupled THMC processes in fractured rock, by using the experimental data and the results of the modeling work above. The modeling plan developed for Task C1 included seven distinct steps. The focus was initially on the novaculite experiment where the simpler geochemistry and more comprehensive fracture topography data make for a more natural starting point (Figure 3.2-10). Teams then moved on to conduct more complex geochemical experiments in granite.

- Step 0: Novaculite: Basic benchmarking and initial models of the early part of the experiment.
- Step 1: Novaculite: More complete models covering only the isothermal part of the experiment
- Step 2: Novaculite: Complete models for the whole experiment
- Step 3: Granite: Basic benchmarking and initial models of the early part of the experiment
- Step 4: Granite: Models covering only the isothermal part of the experiment
- Step 5: Granite: Non-isothermal models
- Step 6: Application (Optional). Blind long-term comparison of the granite models using a synthetic mock-up of a fracture close to a heat generating waste disposal canister.

UFD researchers from Sandia National Laboratories participated as DOE's modeling team in this task (Section 6.1.4). More detail on Task C1 can be found in the DECOVALEX-2015 final report (Bond 2016) available at www.decovallex.org.

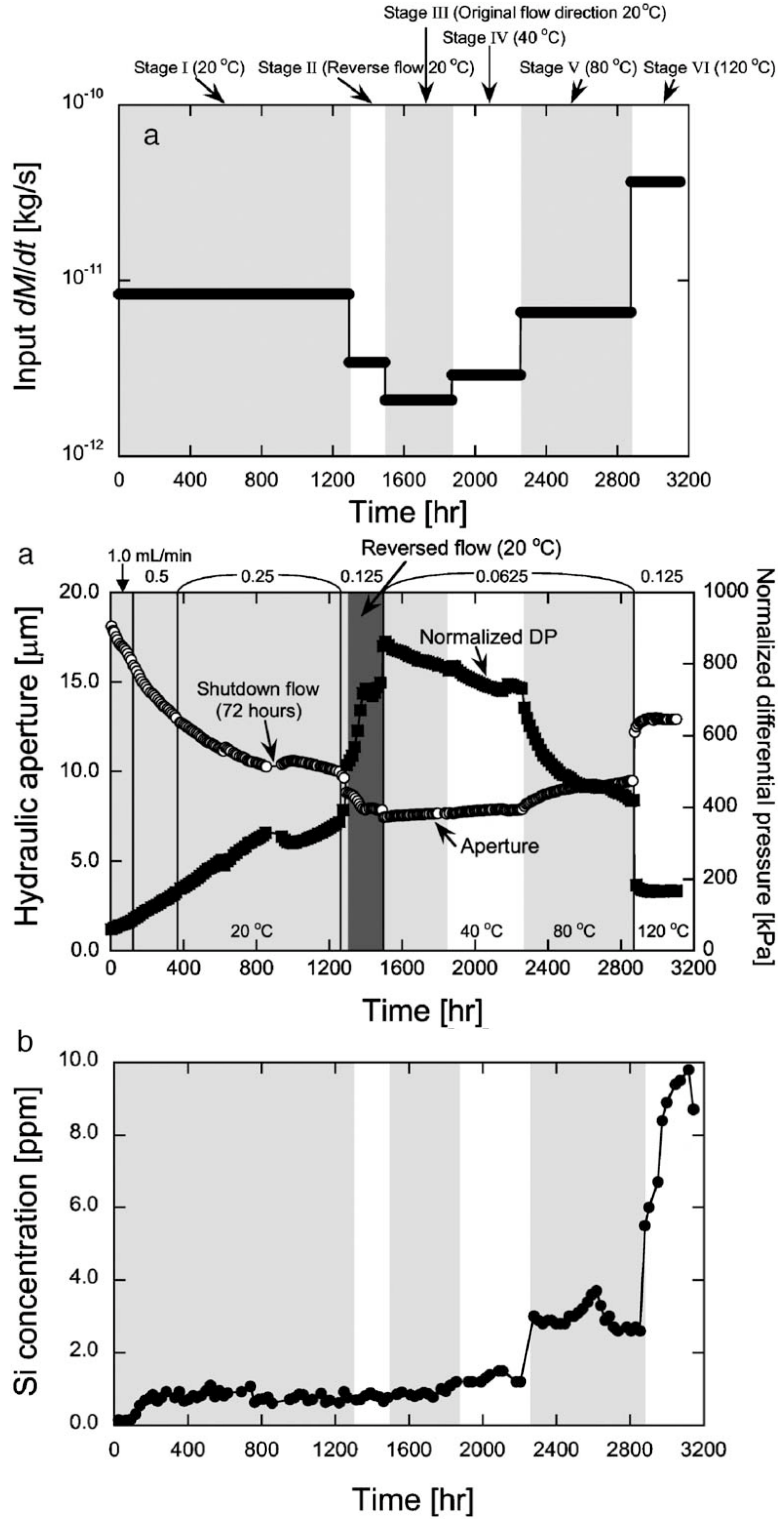

Figure 3.2-9 THMC behavior effects in a single fracture exposed to different external temperatures and varying stress conditions (Yasuhara et al. 2006).

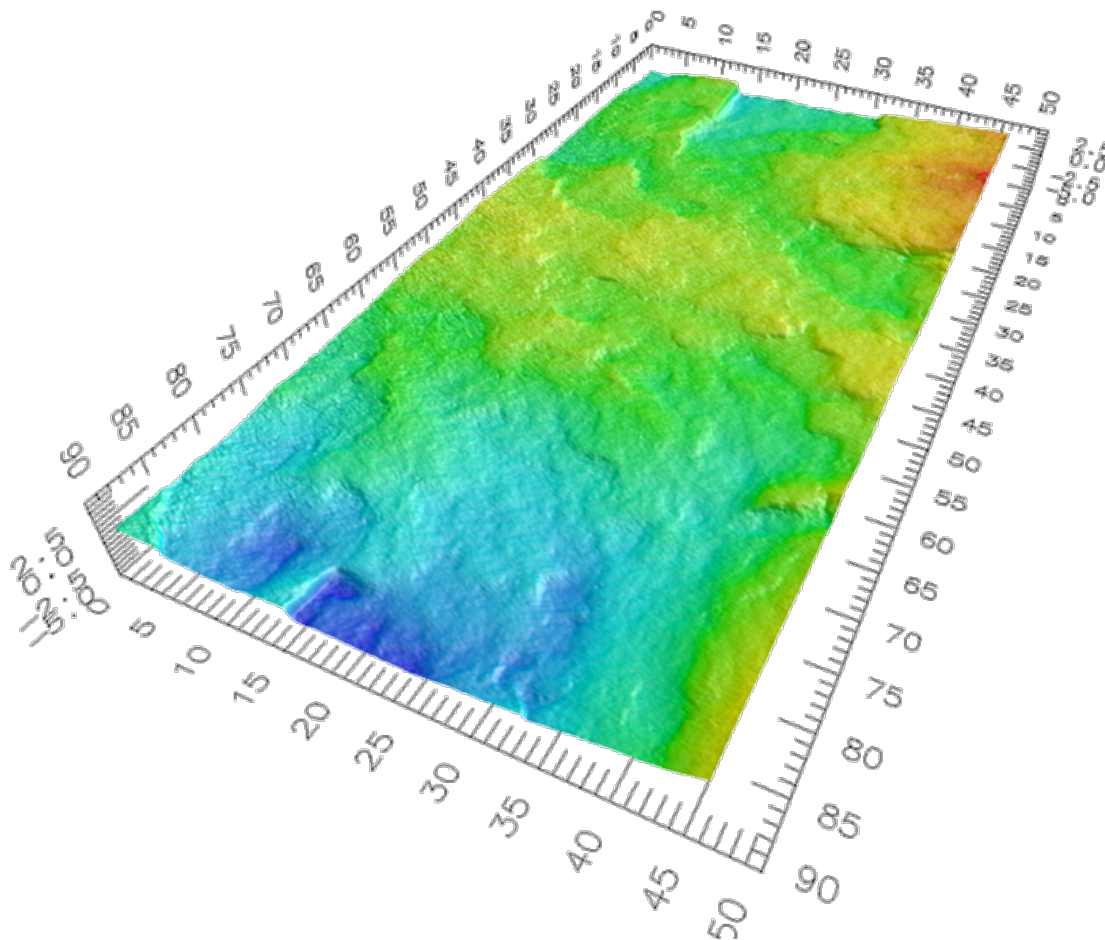

Figure 3.2-10 Fracture surface topography for the novaculite experiment (dimensions in mm) (DECOVALEX web site, www.decovallex.org)

3.2.2.5 Task C2: Bedrichov Tunnel Experiment

The Bedrichov tunnel is an existing tunnel, 2,600 m in length, located in the Northern Czech Republic. The tunnel hosts a water pipe, but was recently made available for geologic studies. SURAO (the Radioactive Waste Management Authority of the Czech Republic) and associated university researchers have been using the tunnel as a preliminary underground laboratory to study the suitability of the Bohemian granitic massif as a host rock for a radioactive waste repository (Figures 3.2-11 and 3.2-12). The site was already selected as a test case for flow models in an earlier DECOVALEX phase, and since then, data collection and interpretation have progressed gradually.

Task C2 of DECOVALEX–2015 used the improved Bedrichov Tunnel data set to gain a better understanding of flow patterns and tracer transport behavior within the fractured rock, between the ground surface (about 120 m above the tunnel axis) and the tunnel, including the zone around the tunnel where mechanical damage has occurred. The main issue to tackle was the inhomogeneity of water inflow along the tunnel axis, i.e., the heterogeneous distribution of water inflow because of conduits of different size and scale (faults, fractures), and relation of water quantity and flow velocity (or residence time). Measured data included tunnel-water inflow patterns and rates, precipitation and infiltration at the ground surface), water temperature, and water chemistry, the latter including chemical composition of major

elements, pH, and several natural isotopes as tracers. Discrete representations of the fracture network surrounding the tunnel had been obtained based on fracture mapping in the tunnel and electrical resistivity profiles (Figure 3.2-13). A comprehensive database has been established, containing data on site geology, fracture mapping (inside the tunnel), resistivity profiles, water inflow, water chemistry, and fracture displacements. The dataset also included stable isotopes of water, tritium, tritiogenic ^3He and noble gases, and dissolved chlorofluorocarbons measured in fracture discharge.

The goal of Task C2 was to model groundwater flow and transport of environmental tracers in the fractured system surrounding the Bedrichov Tunnel, and to utilize these data to constrain fracture-network parameters. The following modeling steps were defined by the task organizers:

- Step 1: Steady-state modeling of flow with average inflow (calibration of hydraulic conductivity and comparison of models between the teams)
- Step 2: Lumped-parameter model interpretation of natural tracers and coarse estimation of residence time
- Step 3: Transient hydraulic model interpretation to understand response of inflow to changing infiltration, for more precise calibration of conductivity, and to evaluate interaction between the shallow and the deep zones
- Step 4: Tracer transport in 3D for calibration of hydraulic parameters and porosity/apertures, with hypothetical pulse tracer (optionally) and actual natural tracer measurements
- Optional Step: 1D models of reaction of infiltrated water with rock minerals, fitting the tunnel inflow ion composition
- Step 5: Evaluation of residence time and other parameter determining uncertainty – comparing models with new data measured during the project

UFD researchers from Sandia National Laboratories participated as DOE's modeling team in this task (Section 6.2.1). More detail on Task C2 can be found in the DECOVALEX-2015 final report (Hokr et al. 2016) available at www.decovallex.org.

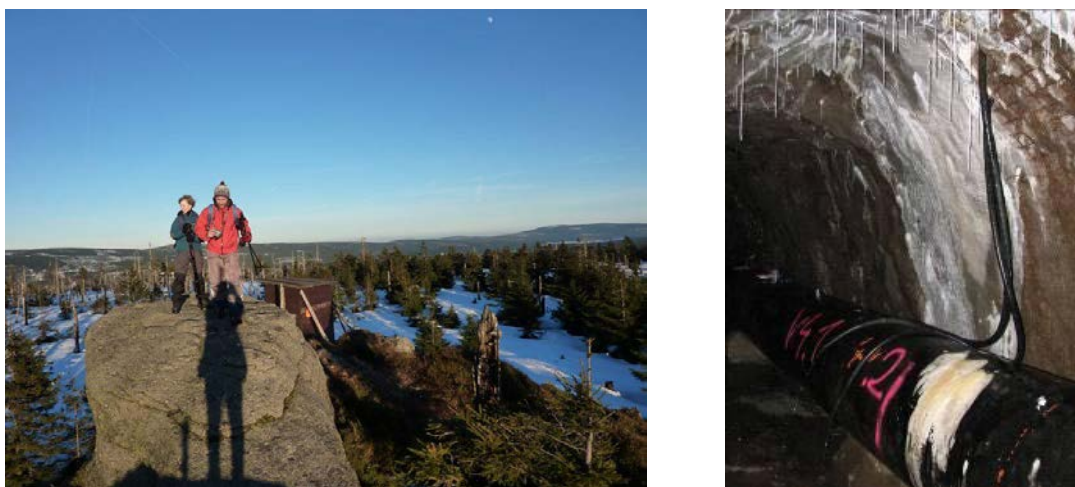

Figure 3.2-11 Bohemian granitic massif in Czech Republic and water inflow evidence in the Bedrichov Tunnel (Hokr and Slovak 2011).

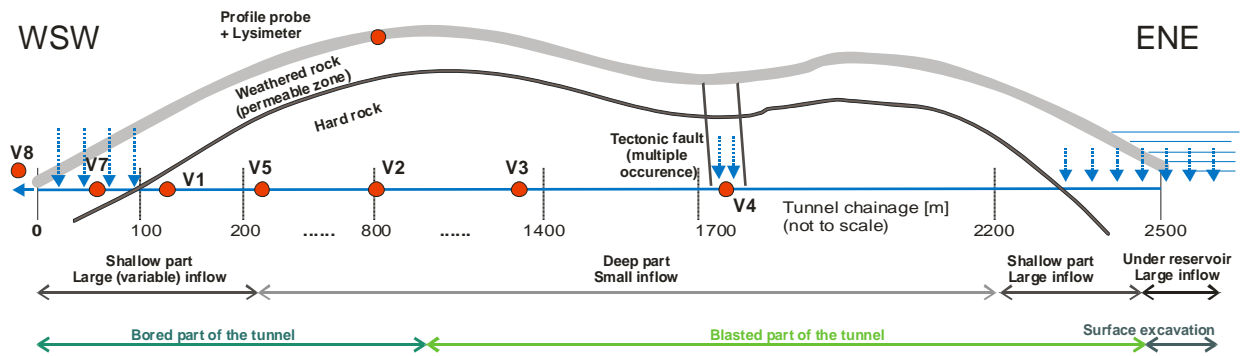

Figure 3.2-12 Profile of the tunnel with basic hydrogeological features and some measurement points (DECOVALEX web site, www.decovalex.org).

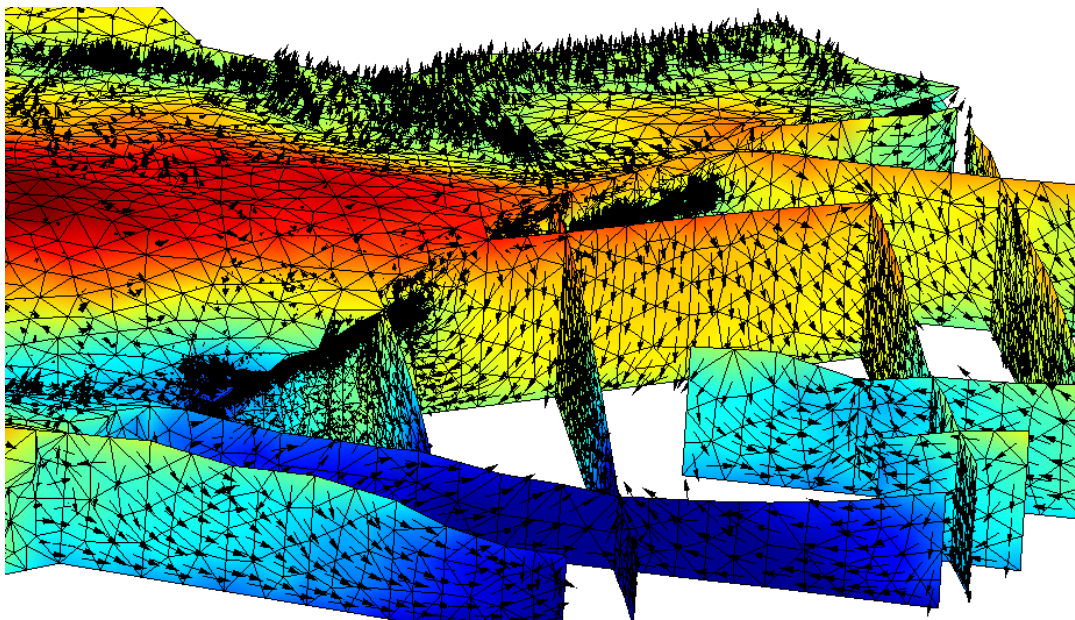

Figure 3.2-13 Example of numerical model of flow at the site, with combined 3D and 2D domains (Hokr et al. 2014).

3.2.3 Modeling Tasks for DECOVALEX-2019

As mentioned before, a new four-year DECOVALEX Project phase started in the spring of 2016, referred to as DECOVALEX-2019. Twelve funding organizations are participating in this new phase as follows:

ANDRA	French National Radioactive Waste Management Agency	France
BGR/UFZ	Federal Inst. for Geosciences & Natural Resources (BGR) and Umweltforschungszentrum Leipzig-Halle (UFZ)	Germany
CNSC	Canadian Nuclear Safety Commission	Canada
DOE	Department of Energy	United States
ENSI	Swiss Federal Nuclear Safety Inspectorate	Switzerland
IRSN	Inst. for Radiological Protection & Nuclear Safety	France
JAEA	Japan Atomic Energy Agency	Japan
KAERI	Korean Atomic Energy Research Institute:	Korea
RWM	Radioactive Waste Management Limited	Great Britain
SSM	Swedish Radiation Safety Authority	Sweden
SURAO	Radioactive Waste Repository Authority	Czech Republic
TaiPower	Taiwan Power Company	Taiwan

Table 3.2-2 Seven task proposals were selected for inclusion in DECOVALEX-2019, based on the level of interest from funding organizations. As is generally the case in DECOVALEX, most of the modeling tasks involve data from experiments conducted in URLs:

- **Task A:**
ENGINEER: Modeling Advective Gas Flow in Low Permeability Sealing Materials (Task Lead: BGS, United Kingdom)
- **Task B:**
Modeling the Induced Slip of a Fault in Argillaceous Rock (Task Lead: ENSI, Switzerland)
- **Task C:**
GREET: Modeling of Coupled Behavior during Groundwater Recovery around a Gallery in Crystalline Rock (Task Lead: JAEA, Japan)
- **Task D:**
INBEB: HM and THM Interactions in Bentonite Engineered Barriers (Task Lead: Polytechnic University of Catalonia (UPC), Spain)
- **Task E:**
Upscaling of Heater Test Modelling Results (Task Lead: ANDRA, France)
- **Task F:**
FINITO: Fluid Inclusion and Movement in the Tight Rock (Task Lead: BGR, Germany)
- **Task G:**
EDZ Evolution: Reliability, Feasibility, and Significance of Measurements of Conductivity and Transmissivity of the Rock Mass (Task Lead: SSM, Sweden)

More information on each of these seven modeling tasks is provided in Sections 3.2.3.1 through 3.2.3.7. DECOVALEX funding organizations are participating as follows:

- Task A: ANDRA, CNSC, BGR/UFZ, DOE, IRSN, KAERI, RWM, TaiPower
- Task B: BGR/UFZ, CNSC, DOE, ENSI, KAERI, TaiPower
- Task C: DOE, JAEA, SURAO
- Task D: IRSN, JAEA, KAERI, SURAO, TaiPower
- Task E: ANDRA, BGR/UFZ, DOE, RWM
- Task F: BGR/UFZ, DOE

- Task G: DOE, SURAO, SSM

Table 3.2-3 Modeling Test Cases for DECOVALEX-2019 (from Bond and Birkholzer 2016).

Task No	A	B	C	D	E	F	G
Task Title	Modelling advective gas flow in low permeability sealing materials	Modelling the induced slip of a fault in argillaceous rock	Modelling of coupled behavior during groundwater recovery around a gallery in crystalline rock	HM and THM Interactions in Bentonite Engineered Barriers	Upscaling of heater test modelling results from small scale to one-to-one scale	Fluid inclusion and movement in tight rock	Reliability, Feasibility and Significance of Measurements of Conductivity and Transmissivity of the Rock Mass
Short Title	ENGINEER	Fault Slip Test	GREET	INBEB	Upscaling	FINITO	EDZ Evolution
Proponent(s)	RWM, British Geological Survey	ENSI	JAEA	ENRESA, UPC	ANDRA	BGR	SSM, Geomecon
Main Concern	Gas migration in clays	Fault slip and pathway creation	Tunnel resaturation in fractured host rock	Bentonite near-field THM evolution	Scaling of results between the small scale TED and 1:1 HA heater tests	Fluid inclusion movement	EDZ hydraulic and mechanical evolution
Repository Stage	Post-closure	Post-closure	Construction and re-equilibration post-closure.	Post-closure	Post-closure	Construction with impact on post-closure	Construction and post-closure
Processes	HM	HM	HMC	THM, THC	THM	THMC	THM
Primary Materials	Bentonite and natural clays (COx)	Opalinus Clay	Granite	Bentonites in granite and clay host rocks	Clay (Callovo-Oxfordian)	Salt and Clay	Granitic rock
Relevance to other rock types	Engineered and natural clay being considered in various host rocks.	Potentially relevant to other indurated clays	Relevant to other crystalline and/or fractured rocks	Engineered clay buffers being considered in various host rocks.	Relevant to all repository concepts using clay host rocks	Other tight rocks	Relevant to other crystalline and/or fractured rocks
Experimental Spatial scales	~10m (True Scale) to cm (lab tests)	Meters	True scale (~50m)	True Scale (~50m)	Small-scale in-situ (~cm) to multi-tunnel (~100 m)	µm to m	~100m
Experimental Time scales	Weeks to Years	Minutes – hours	2 years	10.5 years (EB); 18 years (FEBEX)	Minutes to years	Minutes to years	Application up to 10,000 years

3.2.3.1 Task A: ENGINEER - Modeling Advective Gas Flow in Low Permeability Sealing Materials

This task addresses the fate of repository gases generated over long periods from corrosion of metallic materials under anoxic conditions and related formation of hydrogen. Radioactive decay of the waste and the radiolysis of water are additional source terms for gas production. If the gas production rate exceeds the rate of diffusion of gas molecules in the pores of the bentonite backfill or clay host rock, a discrete gas phase will form. Gas would continue to accumulate until its pressure becomes sufficiently large for it to enter the engineered barrier or host rock, possibly creating advective pathways in the bentonite (Figure 3.2-14). Accumulation and migration will near-field hydrogeological processes, affect potentially coupling to other issues from contaminant transport to fracture/fault reactivation. Understanding and modeling the flow of gas through the seals (which act as chokes in the system) is paramount. There is now a general consensus that in the case of plastic clay-rich clays and in particular bentonite, classic concepts of porous medium two-phase flow are inappropriate and continuum approaches to modeling gas flow may be questionable depending on the scale of the processes and resolution of the numerical model. The “memory” of dilatant pathways within clay may also impair barrier performance, in particular, acting as preferential flow paths for the movement of radionuclides. There is now a consensus that development of new and novel numerical representations, including discrete fracture representations, is required for the quantitative treatment of gas migration in clay-based repository systems, which would be the goal of this DECOVALEX task.

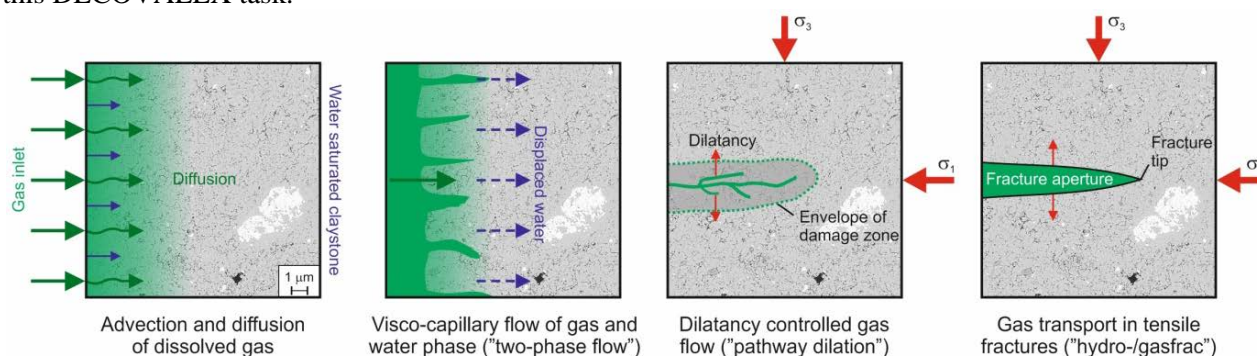

Figure 3.2-14 Processes for movement of gas in low-permeability bentonite (Harrington 2016).

The proposed modeling task utilizes a series of well-instrumented small-scale laboratory experiments that were conducted by the British Geological Survey (BGS). [Task participants are testing new model representations in comparison to a variety of tests that were conducted under different conditions and dimensionalities, ranging from 1D gas flow under isotropically stressed samples to spherical gas flow point under constant volume conditions (Figure 3.2-15). The task is organized into a number of stages, each building on the previous, representing an incremental increase in complexity.] Teams are encouraged to utilize a range of modelling approaches highly mechanistic models which may attempt to replicate nearly all aspects of experimental behaviour to highly simplified homogenised approaches which aim to capture key features of the data. The first stages focus on experiments conducted for bentonite samples; the last stage uses data from a similar experimental setup but this time for gas flow in a natural material, here the Callovo-Oxfordian claystone proposed as a candidate host rock by ANDRA.

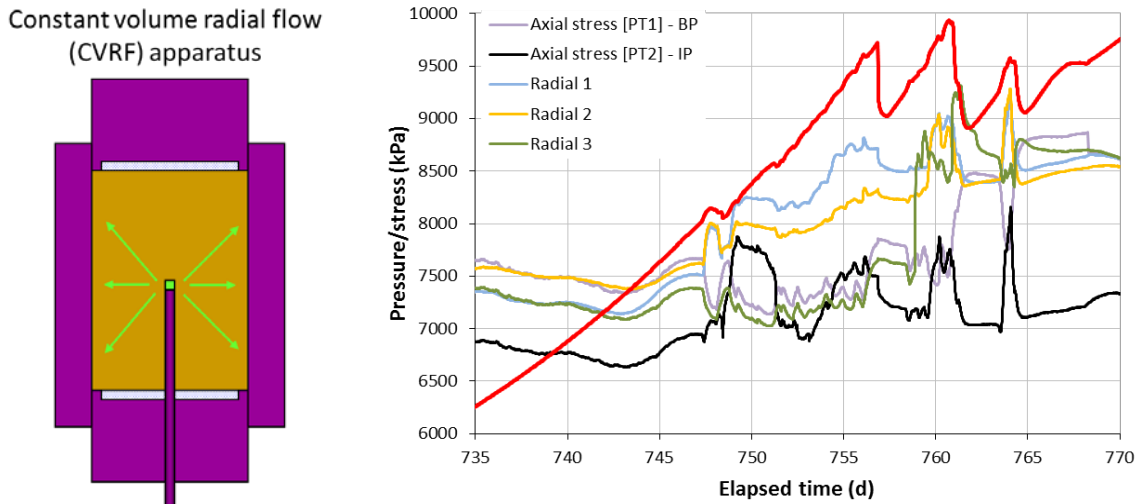

Figure 3.2-15 Typical design and measurements from constant volume flow test conducted at BGS (Harrington et al. 2015).

The proposed task is of high relevance to UFD. The overall objective is to understand the processes and mechanisms governing the advective movement of gas in compact bentonite and natural clay-based materials and its impact on performance assessment. The knowledge gained through understanding the processes and mechanisms governing gas flow is of direct relevance to many repository concepts that use compacted bentonite in deposition holes, boreholes or gallery seals.

3.2.3.2 Task B: Modeling the Induced Slip of a Fault in Argillaceous Rock

This modeling task evaluates the conditions for slip activation and stability of faults in clay formations and in particular addresses the complex coupling between fault slip, pore pressure, permeability creation, and fluid migration. This subject is of great importance to many subsurface applications where injection of fluids leads to pore-pressure increase and reduction of effective normal stresses on faults, which in turn can cause fault reactivation. Regarding radioactive waste emplacement, increases in pore pressure could be caused by release of heat from the high-level waste or by the generation of gas due to steel corrosion. The possibility of an increased permeability caused by fault slip and generation of potential pathways in the host rock or in an upper sealing formation could be a major risk for the long-term safety of a repository.

The central element of the proposed task is the FS Fault Slip Experiment conducted at Mont Terri (Section 3.1.5), which utilized a novel experimental setup for controlled fault slip testing in realistic underground settings at field scale. As shown in Figure 3.2-16, a borehole intersecting a fault was equipped with a borehole probe (High-Pulse Poroelasticity Protocol probe or HPPP probe) consisting of a straddle packer system that can be stepwise pressurized via fluid injection. High-resolution devices measured at unprecedented resolution both axial and radial micro-scale deformations at the borehole wall while monitoring downhole fluid pressure and flow rate as the fault is slipping. Of the five injection tests conducted in different boreholes and different intervals at Mont Terri, two tests were selected for modeling within Task B of DECOVALEX-2019. The tests provide data for activation of the main fault as well as a minor fault in the fault damage zone, respectively.

The modelling task is organized in a stepwise approach. Task 1 comprises benchmark simulations to evaluate the activation of a simplified fault plane representing the minor fault to be modelled in Step 2. This allows for necessary model developments and comparative testing related to modelling of fault activation processes, such as developing and testing new constitutive models for fault hydro-mechanical behavior. Task 2 comprises interpretative modelling of the observed activation and hydromechanical

behavior of the minor fault. A full set of experimental data will be distributed to the modelling teams before the start of Step 2. Task 3 then moves the teams into a final stage to perform interpretative modelling of the complex activation patterns observed in the main fault at Mont Terri, which resulted in strong shear activation and considerable permeability changes.

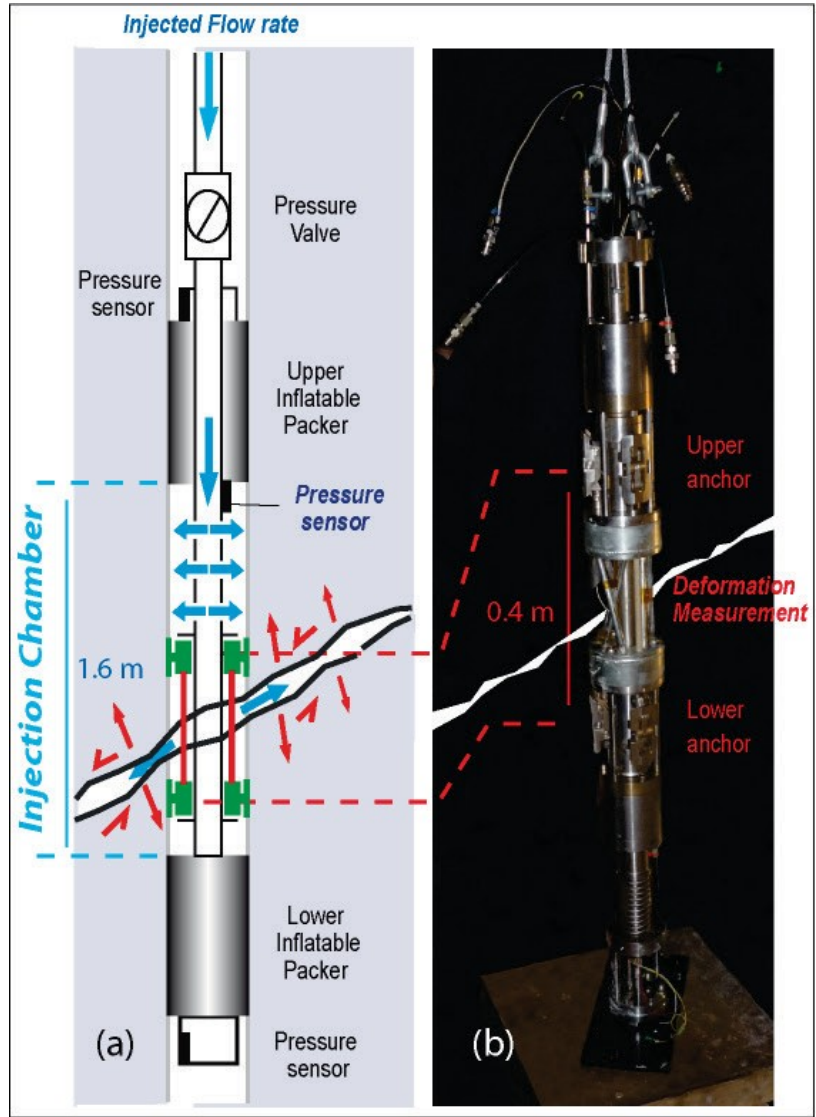

Figure 3.2-16 Basic design of fault slip experiment and measured deformation along and normal to fault plane (Graupner et al. 2016).

3.2.3.3 GREET: Groundwater Recovery around a Gallery in Crystalline Rock

GREET is a full-scale experiment being conducted in the Japanese Mizunami URL (crystalline rock). The objective of the test is to evaluate the processes and implications of natural resaturation of the repository near-field environment after construction and before repository closure. To test these processes, GREET is essentially a drift closure and water-filling experiment, measuring, for example, the mechanisms of groundwater recovery, alkalization of groundwater, microbial redox change, and hydraulic conductivity reduction in fractures by filling with cementing materials. The goals are as follows: (1) to understand the water recovery processes and mechanisms of the geological environment during facility closure, (2) to verify coupled hydrological-mechanical-chemical and -biological simulation methods for modeling these processes, and (3) to develop monitoring techniques for the facility closure phase and appropriate closure methods taking recovery processes into account. Figures 3.2-16a and 3.2-17 show, respectively, the test design with an inclined tunnel leading to a sealed-off drift section, and an example of the hydrogeologic data available for the near-field fractured rock mass.

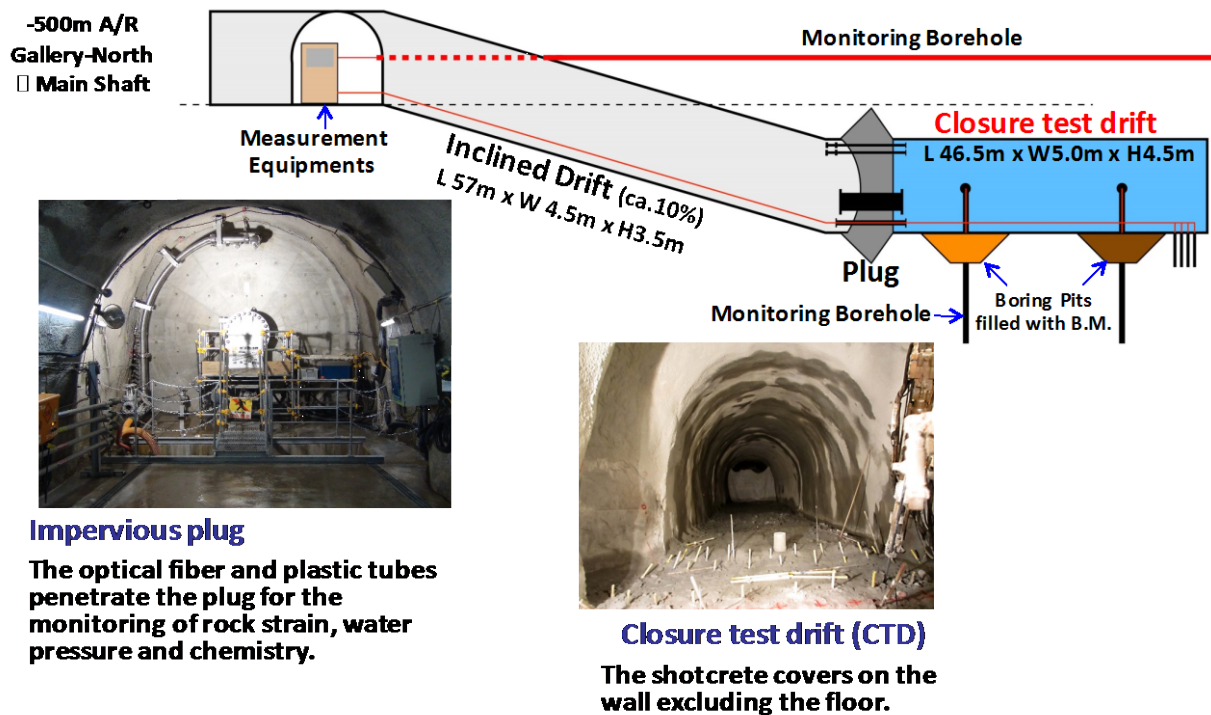

Figure 3.2-16a Schematic showing GREET tunnel design in a cross-section and photos taken during construction (Iwatsuki 2016).

The task is organized into three different modelling stages that coincide with the major stages in the GREET Experiment: (1) excavation of the closure test drift (CTD), (2) hydrological recovery during filling of the CTD, and (3) evaluation of the long-term steady-state recovery conditions. Figures 3.2-18 and 3.2-19 explain which data will be made available for modelling teams, for the predictive “blind” simulation stage and later for a validation stage.

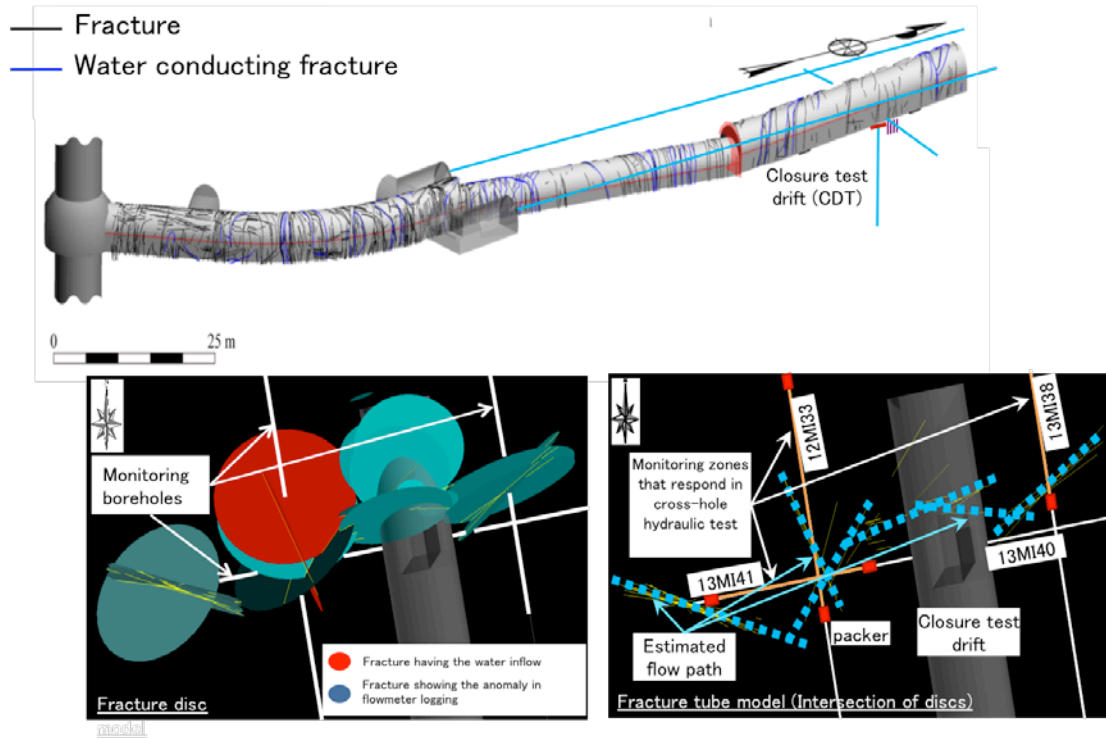

Figure 3.2-17 Flowing and non-flowing fracture in closure test drift (CTD) (Sugita 2015).

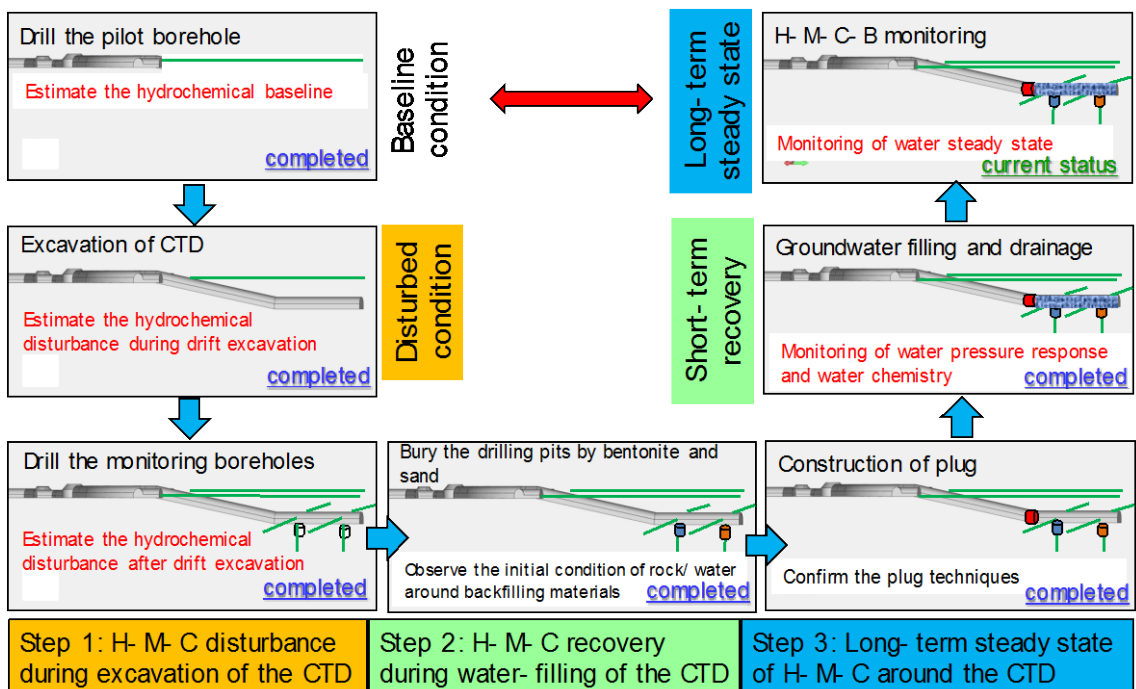

Figure 3.2-18 Proposed experimental sequence for GREET task (Iwatsuki 2016).



Step	Simulation	Validation data
<p>Step 1: H-M-C disturbance during excavation of the CTD</p> 		
		
		<p>oring boreholes during monitoring</p>

Figure 3.2-19 Data from GREET used for prediction and validation of H-M-C models (Iwatsuki 2016).

3.2.3.4 Task D: INBEB - HM and THM Interactions in Bentonite Barriers

The objective of the INBEB task is the interpretation and modeling of the performance of an initially inhomogeneous bentonite barrier using two full-scale long-term experiments. These are the isothermal Engineered Barrier experiment (EB), which ran for over ten years at the Mont Terri URL (Section 3.1.4), and the non-isothermal FEBEX experiment which ran for over 18 years at the Grimsel Test Site (Section 3.3.2). The evolution from an installed unsaturated engineered system to a fully functioning barrier will be assessed with HM and THM models in comparison to experimental data. This requires an increased understanding of material behavior and properties, an enhanced understanding of the fundamental processes that lead to barrier homogenization, and improved capabilities for numerical modeling.

In both full-scale experiments, the bentonite component and surrounding host rocks were instrumented at high spatial resolution. In addition, both tests (EB and FEBEX) have been dismantled after 10 years and 18 years of operation respectively; thus there is the unique opportunity to observe the final state of the bentonite barrier after saturation and homogenization (and in the case of the FEBEX test, after 18 years of heating). Figure 3.2-20 illustrates results available from dismantling and sample analysis, in this case for the bentonite density distributions in four cross-sections of the EB Experiment; Figure 3.2-21 shows similar results for the FEBEX test after dismantling.

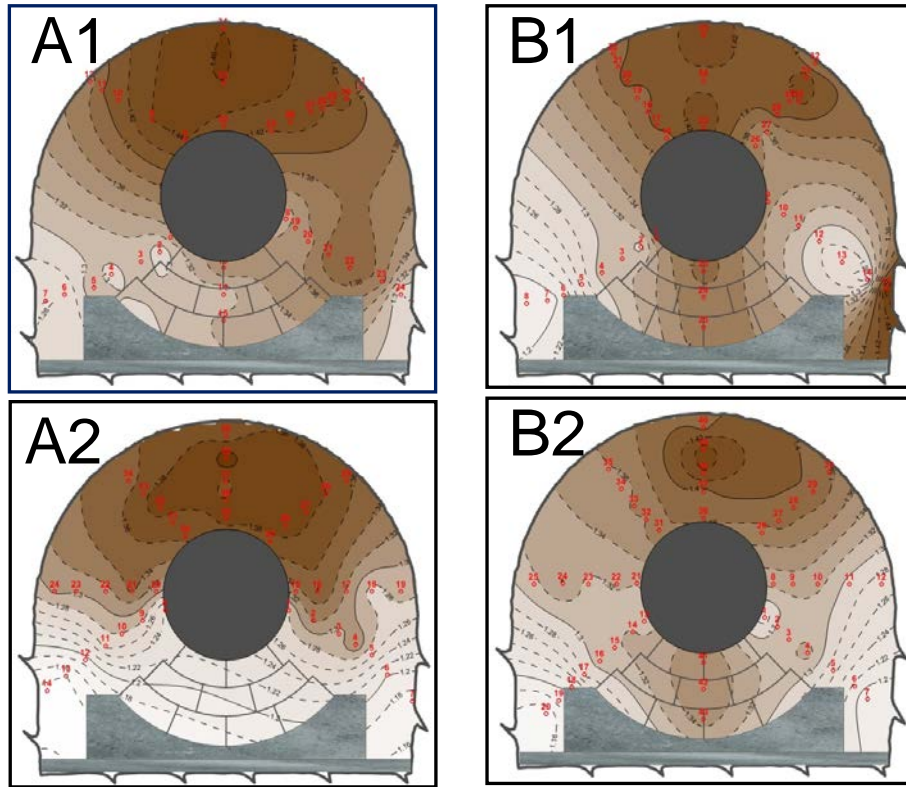

Figure 3.2-20 Example results from EB dismantling project: distribution of bentonite density in four different cross sections (Mayor and Gens 2015).

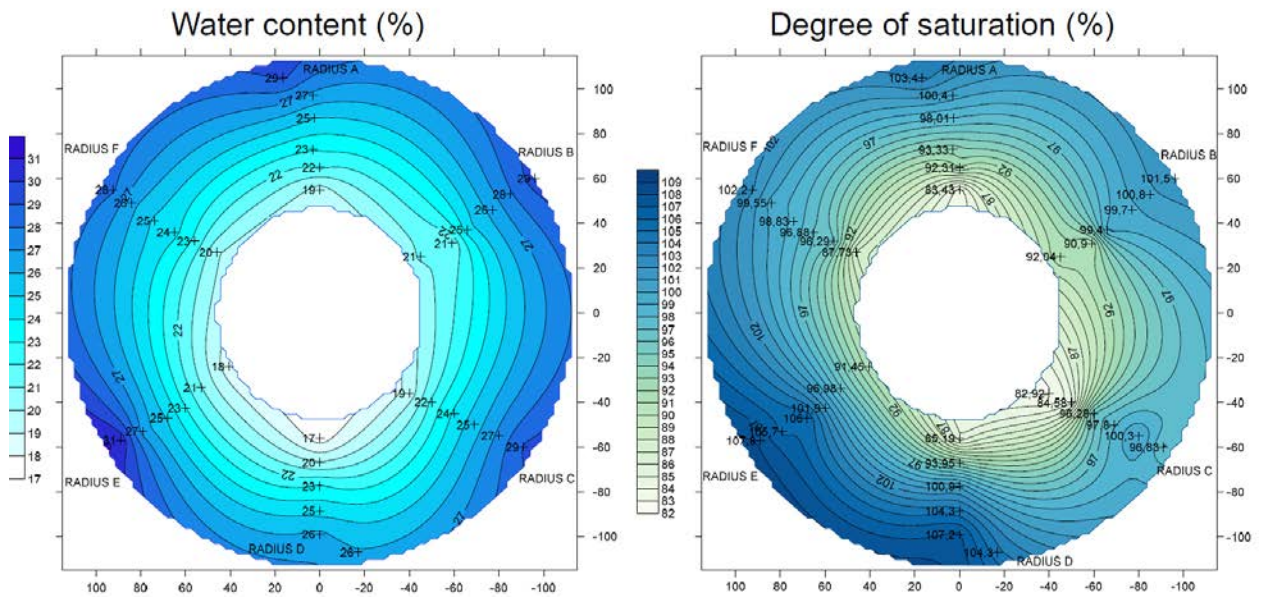

Figure 3.2-21 Example results from FEBEX DP: distribution water content and saturation after 18 years of heating (Zheng 2016).

3.2.3.5 Task E: Upscaling of Heater Test Modeling Results from Small-scale to Full-scale

The purpose of Task E is upscaling THM modeling from small size experiments (some cubic meters) to real scale emplacement cells (some ten cubic meters) all the way to scale of a waste repository (cubic kilometers). The task is aligned with the French repository program, which focuses its R&D on the Callovo-Oxfordian claystone (COx) formation near Bure in the east of France. The French repository design assumes that waste canisters will be placed horizontally in a series of parallel micro-tunnels drilled from access drifts, each microtunnel about 80 m long and 0.7 m in diameter (Figure 3.2-22). A comprehensive research program was conducted in the Meuse/Haute-Marne URL near Bure to investigate the THM response of the COx to thermal loading from parallel microtunnels, through laboratory and in situ experiments. The in situ experimental program consists of a step-by-step approach ranging from small-scale heating boreholes (TED experiment) to full-scale experiments (ALC experiment). Results from these heater experiments are utilized in Task E.

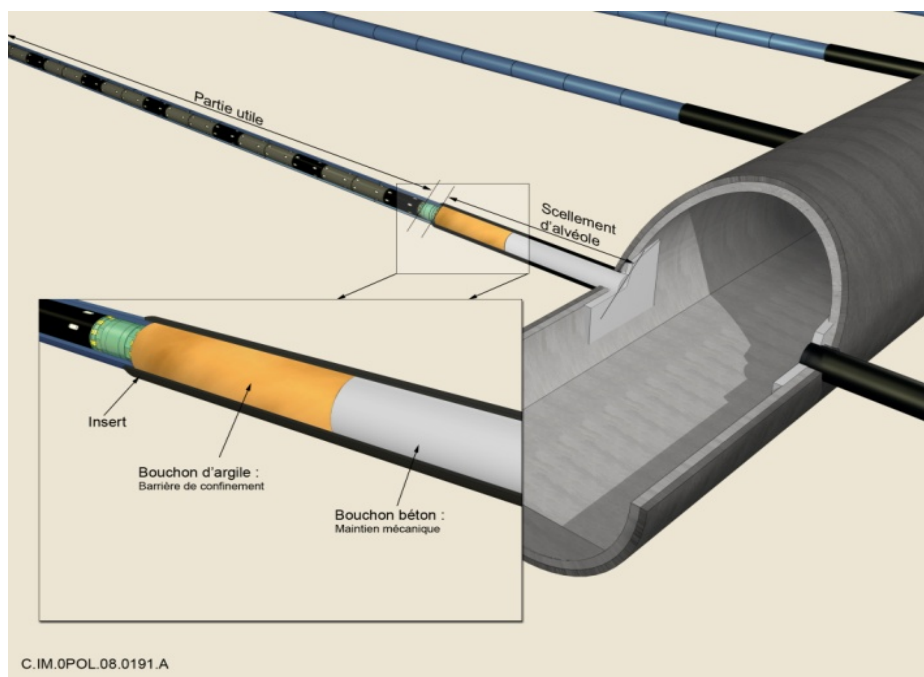

Figure 3.2-22 French design for disposal in argillaceous rock, with waste packages stored in horizontal microtunnels (Vitel et al. 2016).

Like in most other DECOVALEX tasks, the modeling program is organized in several sub-tasks, in this case including a benchmark test, an interpretive exercise, a blind prediction, and a large-scale application. In a first step, the models used are benchmarked in 3D to validate the correctness of code implementation considering THM processes. The second step consists of an interpretative modeling of a small-scale *in situ* heating experiment (TED) realized in ANDRA's URL (Figure 3.2-23). The TED experiment, which started in 2010 and ended in July 2013, involved three heaters in three boreholes parallel to each other at a distance of about 2.7 m. The third step involves the interpretation and modeling of a full scale heating experiment (ALC experiment, see Figure 3.2-24) based on model calibrations performed at a smaller scale (TED experiment). ALC is an ongoing *in situ* test designed as a full-scale representation of one single emplacement micro-tunnel. The interaction between the surrounding rock and the support (steel casing in this case) is closely investigated through this full-scale scale experiment to assess the effect of the thermal loading on the steel structure. The extent of the behavior of one single emplacement cell relative to behavior at the repository scale (several parallel emplacement cells) will be approached in a last step.

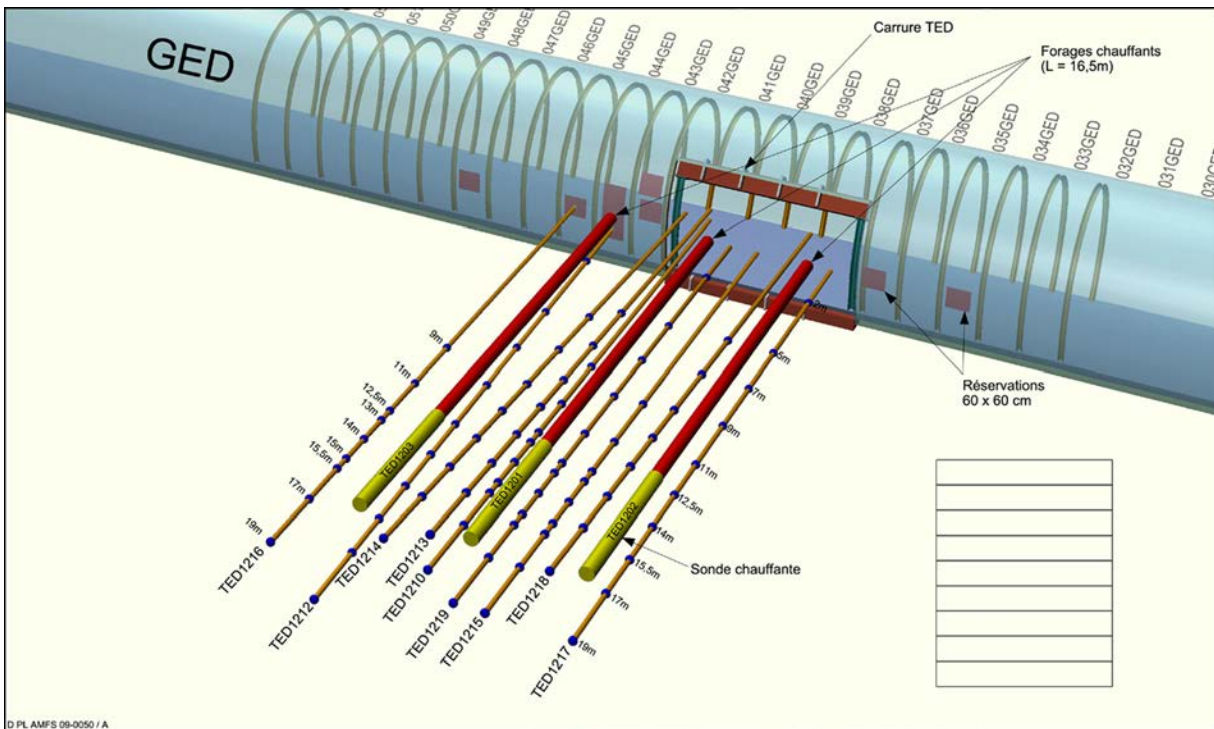

Figure 3.2-23 Basic design of TED experiment conducted at Bure (Vitel et al. 2016).

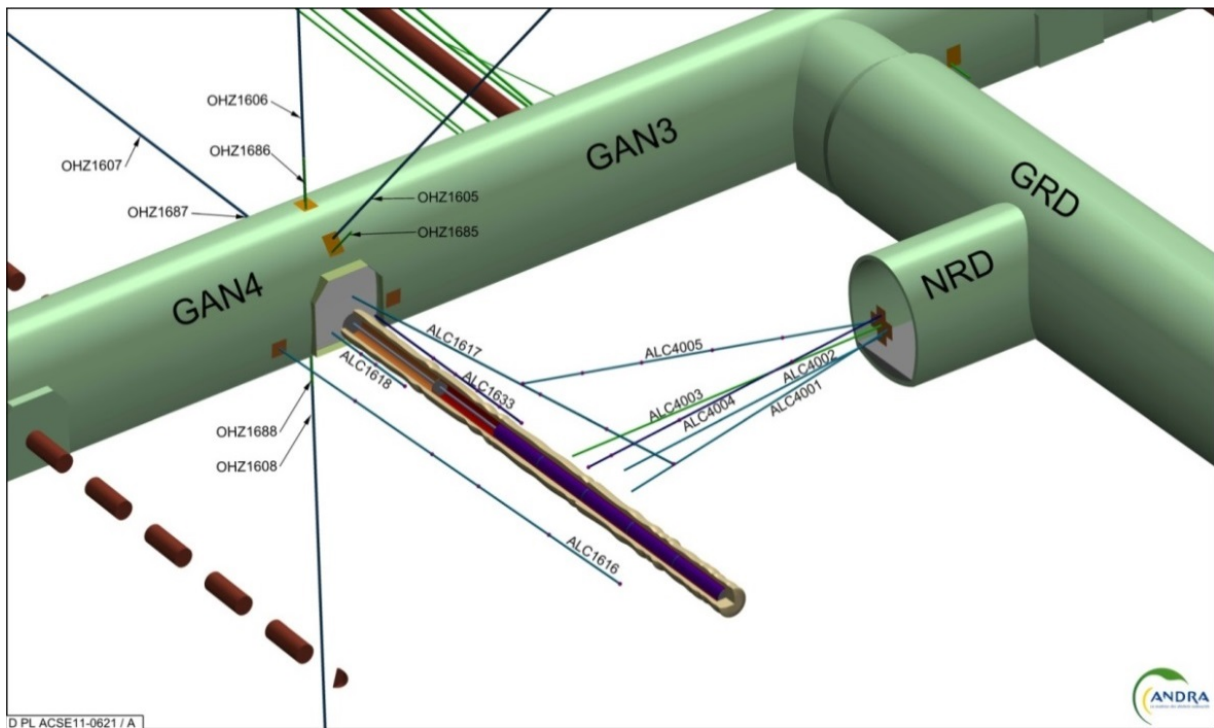

Figure 3.2-24 Basic design of ALC experiment conducted at Bure (Vitel et al. 2016).

3.2.3.6 Task F: Finito - Fluid Inclusion and Movement in the Tight Rock

The purpose of Task F is to refine and compare modeling approaches for the behavior of fluid inclusion in tight low-permeability rock, such as salt or clay. Fluids including liquid and gas phases can be found within the crystal structure or along grain boundaries in all types of sedimentary rock and were formed by accumulating and reacting of different mineral and/or organic particles under pressure and temperature conditions during the genesis. These small inclusions range in size of several micrometres and are usually invisible in detail without microscopic studies. However, these fluids usually dispersed in a very low amount can form local accumulations in a rock volume up to some cubic meters.

Because of the very low rock permeability, migration of such fluids is almost impossible even under high pressure-gradient conditions. Fluid release from the crystal structure will only take place if the stress state changes. In case of drilling or excavation, stress will be redistributed with the result of a deviatoric stress state. If fluid pressure is higher than the minimal principal stress, dilatancy-controlled fluid migration occurs. This results in the generation of micro-fissures between crystal structures with an increased permeability. With regard to the long-term performance of a potential repository, it is important to characterise the distribution, amount and interconnectivity of the fluid inclusions. It is also important to determine the permeability of micro-fissures and to characterise the hydraulic properties after the fluid release.

Teams involved in this task will collaborate to improve process understanding and model concept development. Modelling of experimental data (typically from microscopic observations, Figure 3.2-26, or from laboratory migration experiments, Figure 3.2-27) requires a comprehensive effort, because a quantitative measurement at the microscale is not possible. An upscaling process from the microscale process description to the macroscale observation is necessary. It is expected that the teams will adopt different approaches but that in all cases the different approaches should all provide insight into the development of robust, predictive THMC analysis.

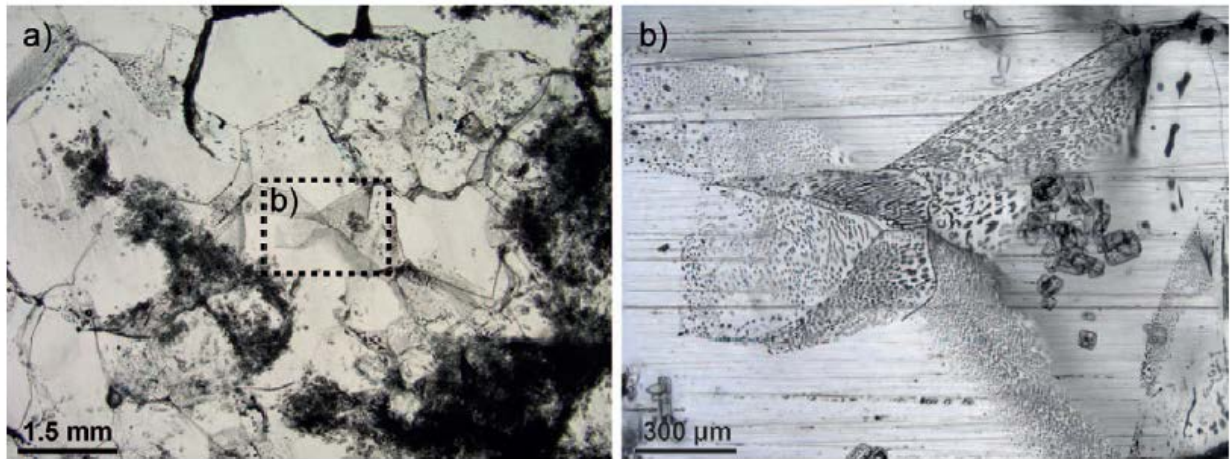

Figure 3.2-26 Halite grain boundaries decorated with fluid inclusions (Shao 2016).

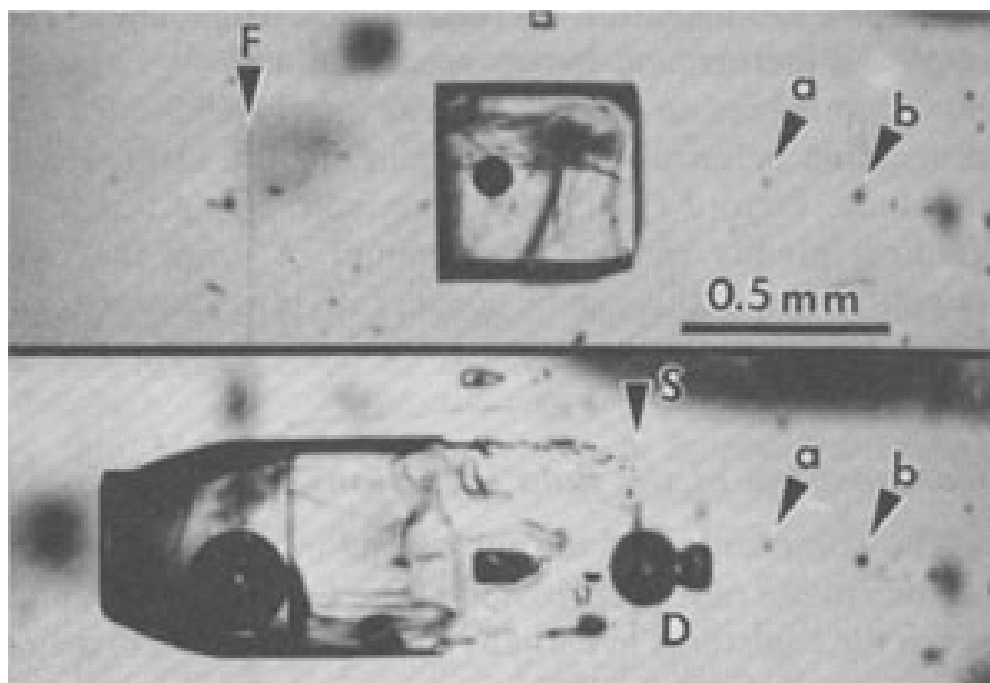

Figure 3.2-27 Fluid migration of a fluid inclusion in a salt grain, driven by the thermal gradient (Shao 2016).

3.2.3.7 Task G: EDZ Evolution: Reliability, Feasibility, and Significance of Measurements of Conductivity and Transmissivity of the Rock Mass

The objective of the task is improving our understanding of formation of an excavation damage zone (EDZ) in crystalline rock and its impact on change of hydraulic properties of the host rock mass near the excavations of spent fuel repositories. A specific focus is on the challenges and uncertainties for measurement and monitoring of rock mass permeability evolution during construction and operation of a repository hosted in granitic rock in Sweden. A good knowledge of the hydraulic property evolution of fractured crystalline rocks is a key item of Safety Assessment (SA)/Performance Assessment (PA) of repositories in such host rocks, where adequate understanding of the EDZ induced hydraulic permeability changes and its evolution during the full process of repository construction, closure and post-closure monitoring is necessary to meet the performance targets, and to evaluate the impact of the long-term process changes, such as glaciation, on the long-term safety functions. The main processes to be simulated are the coupled thermo-hydro-mechanical processes of fractured granite rocks during repository construction, closure and post-closure monitoring, with evolution of hydraulic properties (permeability) changes under heating/cooling by radioactive waste decay, EDZ (near-field) and glaciation (far-field) effect on mechanical and hydraulic property change for fracture systems and rock matrix during the full process of repository construction, closure and post-closure monitoring. Task G uses results from the TAS04 Experiment conducted in an alcove at Äspö as a reference case, with comprises data of EDZ extension due to drill-and-blast based on geophysics, fracture system distribution from field mapping data (from tunnel floor and 40 boreholes), and hydraulic properties of EDZ from pumping and interference tests. Figure 3.2-28 shows example data from TAS, showing hydraulic connectivity and transmissivity based on injection tests in short boreholes.

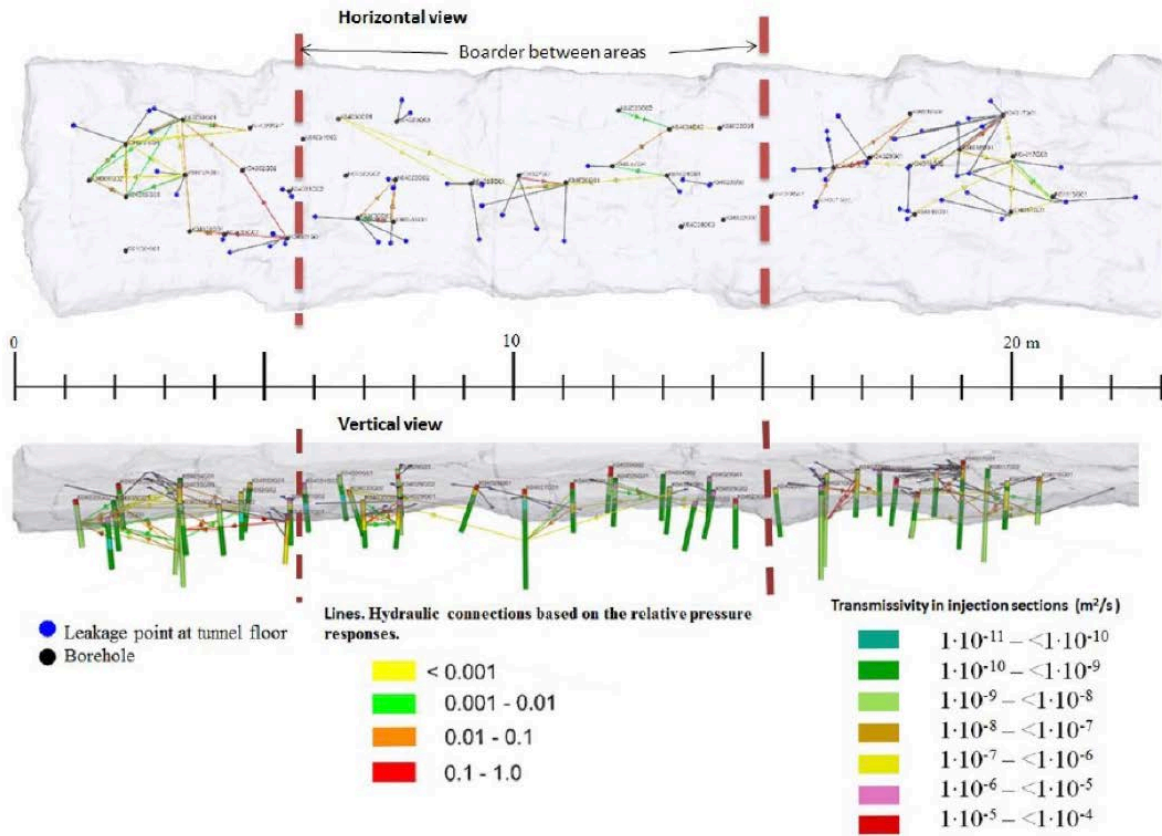

Figure 3.2-28 Top: hydraulic connectivity, expressed as relative pressure disturbance from <0.001 to 1. Bottom: transmissivities obtained from injection tests. The dotted red lines indicate areas where there is no observation of any hydraulic connectivity (Lanaro 2016).

Task G is structured in three stages that will be undertaken consecutively over the duration of the project, identified as Work Packages 1, 2 and 3

WP1: Model Testing

- Basic hydro-mechanical options for the rock mass are tested and validated in 2D and 3D

WP2: TAS Reference Case with Inflow Estimates

- 3D Simulation of the TAS-experiment at Äspö

WP3: Long-term Transmissivity Changes Including Temperature and Damage Effects

- 3D Simulation of the transmissivity evolution during the phases of a repository (up to 100,000 years)
- 3D Simulation of effect of rock damage, extension of fractures, and the evolution of the fracture network

3.2.4 DECOVALEX Summary

Benefits of Participation:

- Access to **four to seven** sets of experimental data from **different** URLs and **different** host rock environments
- Opportunities for **modeling and analysis of existing data** in collaboration with other modeling groups (typically less direct interaction with the project teams that run or interpret the experiments)
- Opportunity to suggest **modeling test cases** of interest to DOE.

Status of Participation:

DOE formally joined the DECOVALEX project in 2012, with the start of the DECOVALEX-2015 phase. Researchers affiliated with UFD participated in two DECOVALEX-2015 tasks, namely Tasks B and C (Sections 6.1.1.2, 6.1.1.3 and 6.2.1). A new DECOVALEX phase (referred to as DECOVALEX-2019) started in the spring 2016 with a kick-off workshop held in Berkeley, and will run for four years until the end of 2019. DOE continues its membership in DECOVALEX-2019, and plans to participate in five of the seven tasks.

Outlook:

As discussed in Section 3.2.3, many of the seven new DECOVALEX-2019 tasks are of high relevance for UFD, and given the relatively small annual membership fee, the benefit of participating in DECOVALEX is very high. Dr. Jens Birkholzer of LBNL has assumed the position as Chairman of the DECOVALEX project, which will help ensure that DECOVALEX tasks continue to be of importance to DOE's R&D goals.

Contact Information:

DOE Contact:
Mark Tynan, DOE-NE

UFD Contact:
Jens Birkholzer, LBNL

DECOVALEX Contact:
Jens Birkholzer, Chairman of DECOVALEX-2019, LBNL, USA
Alex Bond, DECOVALEX Technical Coordinator, Quintessa, United Kingdom

3.3 Grimsel Test Site Projects

The Grimsel Test Site (GTS) is a URL situated in sparsely fractured crystalline host rock in the Swiss Alps. The URL was established in 1984 as a center for underground R&D supporting a wide range of research projects on the geologic disposal of radioactive waste (Figure 3.3-1). GTS provides an environment, analogous to that of a repository site, thus allowing the development and testing of equipment, methodology, and models under fully realistic conditions. GTS is a research facility and not a potential repository site, though investigations may utilize a wide range of radioactive tracers. NAGRA, as the site operator, has organized most experimental activities in the URL as multinational collaborative projects, which typically include several partners from Europe, Asia, and North America. Participation in these collaborative projects requires formal project agreement between NAGRA and its partners. As discussed below, DOE has been quite involved with GTS activities. For example, DOE was a partner in the Colloid Formation and Migration Project (CFM) at GTS from 2012 through 2015, is currently a participant in the FEBEX Dismantling Project (FEBEX-DP) at GTS, and is one of several international organizations engaged in planning a high-temperature heater test project (HotBENT) that would be conducted at GTS.

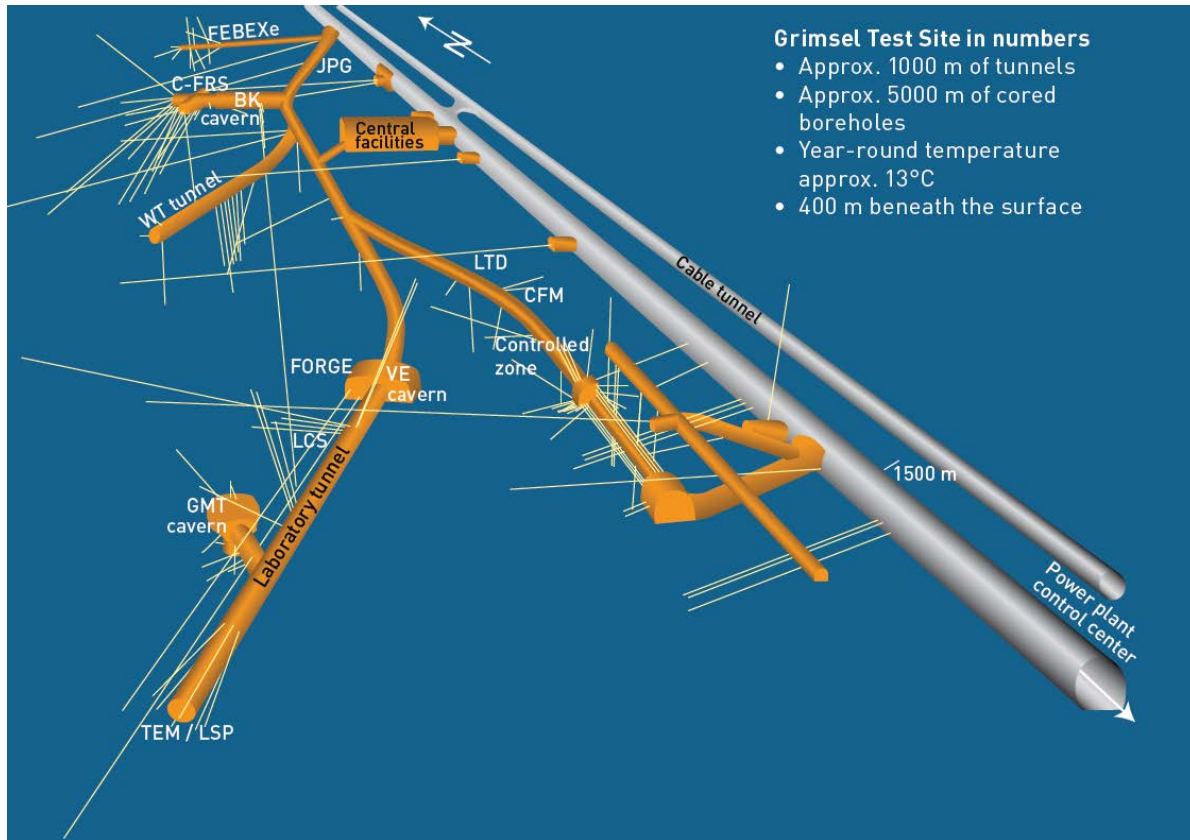

Figure 3.3-1 3D view of layout of the Grimsel Test Site in Switzerland (NAGRA 2010).

3.3.1 Colloid Formation and Migration Project

3.3.1.1 Overview of the CFM Project

The Colloid Formation and Migration (CFM) Project is an international research project for the investigation of colloid formation/bentonite erosion, colloid migration, and colloid-associated radionuclide transport, relevant to both NBS and EBS areas of UFD. Colloid-related R&D at GTS comprises *in situ* migration experiments conducted between boreholes in a fracture shear zone; these are complemented by laboratory and modeling studies. The main R&D objectives are as follows:

- To examine colloid generation rates and mechanisms at the EBS–host rock boundary under *in situ* conditions
- To study the long-term geochemical behavior (mobility, mineralization, colloid formation, etc.) of radionuclides at the EBS–host rock interface
- To evaluate the long-distance migration behavior of radionuclides and colloids in water-conducting features in a repository-relevant flow system (i.e., with a very low flow rate/water flux)
- To examine reversibility of radionuclide uptake onto colloids
- To gain experience in long-term monitoring of radionuclide/colloid propagation near a repository.

The CFM project was preceded by the Colloid and Radionuclide Retardation (CRR) project, conducted at the Grimsel Test Site from 1997 to 2003. Twenty-seven field tracer tests were conducted during the CRR, including seven that involved short-lived radionuclides, one involving a suite of long-lived radionuclides with isotopes of U, Np, Am, and Pu, and one involving a suite of radionuclides (including Cs, Sr, Tc, U, Np, Am, and Pu isotopes) injected with bentonite colloids. Colloid-facilitated radionuclide transport was quantified by comparing the breakthrough curves of the radionuclides in the latter two tests (with and without the colloids). Similar tests with and without colloids were also conducted using nonradioactive homologues of actinides (e.g., stable isotopes of Th, Hf, and Tb). All of the CRR tests were conducted as weak-dipole tests between boreholes completed in a fracture shear zone, with the tests involving radionuclides being conducted between boreholes separated by 2.2 m. Tracer residence times in all tests were no more than a few hours.

The CFM project was initiated soon after the Grimsel Test Site transitioned to Phase VI testing in 2004. While similar in many respects to the CRR project, the CFM project aimed to improve or expand upon CRR in two key areas: (1) increase tracer residence times in the fracture shear zone to allow interrogation of processes that may not be observed over the very short time scales of the CRR tests (e.g., colloid filtration, radionuclide desorption from colloids), and (2) directly evaluate the performance of bentonite backfill with respect to swelling, erosion, and colloid generation, by emplacing a bentonite plug into a borehole completed in the fracture shear zone. To accomplish these objectives, a “tunnel packer” system was installed to seal off the entire access tunnel (Figures 3.3-2 and 3.1-3) where it was intersected by the shear zone. With this packer system, the flow rate from the shear zone into the tunnel could be throttled back from a natural rate of ~700 mL/min to any desired value, and the water from the shear zone could be collected in a controlled manner. Boreholes penetrating the shear zone could then be used as injection boreholes for tracer tests or for emplacement of the bentonite plug, with the tunnel packer effectively serving as an extraction location.

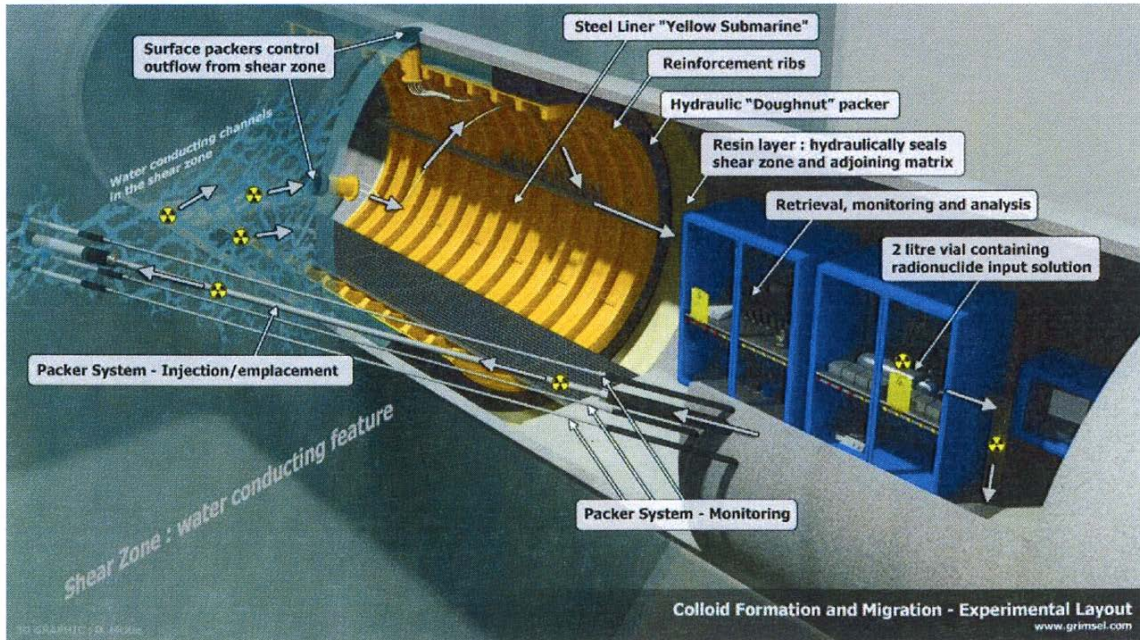

Figure 3.3-2 Schematic illustration of the CFM field test bed at Grimsel Test Site (Reimus 2012).



Figure 3.3-3 CFM field test bed at Grimsel Test Site: Tunnel packer system used to isolate the shear zone (<http://www.grimsel.com/gts-phase-vi/cfm-section/cfm-site-preparation>). Small disks with tubing issuing from them (inside yellow packer) are “surface packers” that seal the tunnel wall and collect water from inflow points. Tunnel diameter is 3.5 meters.

Seven conservative (nonsorbing) tracer tests were conducted in late 2006 through 2007 at various shear zone flow rates using different boreholes as injection holes to test the tunnel packer system and to evaluate tracer residence times that could be achieved. Tracer transport pathways in these tests and in all the CRR tests are depicted in Figure 3.3-4, which shows the locations of several boreholes relative to the main tunnel within the shear zone. Borehole CFM 06.002, drilled in 2006 for the CFM project, was established as the primary injection borehole to be used in subsequent tracer testing involving colloids, homologues, and radionuclides. Tests were conducted with injections of tracer solutions into borehole CFM 06.002 while extracting water from the Pinkel surface packer located at the tunnel wall ~6.2 m from the injection interval. In 2008, a tracer test was conducted in which a bentonite colloid solution with homologues presorbed onto the colloids was injected into CFM 06.002 (referred to as Test 08-01, where the first number indicates the year and the second number indicates the sequential test for that year). This test was followed immediately with a conservative tracer test in the same configuration. Based on lessons learned from these tests, a series of five more tests was conducted in 2009 and 2010. Three of these included only conservative tracers, and two included bentonite colloids and homologues in addition to conservative tracers (Test 10-01 and 10-03). In 2012 and 2013, the CFM Project conducted new tests (12-02 and 13-05) involving the injection of a radionuclide-colloid cocktail including the actinides Pu(IV) and Am(III) into injection interval CFM 06.002. This experiment evaluated the transport of bentonite colloids with radionuclides from the source to the extraction point at the tunnel wall.

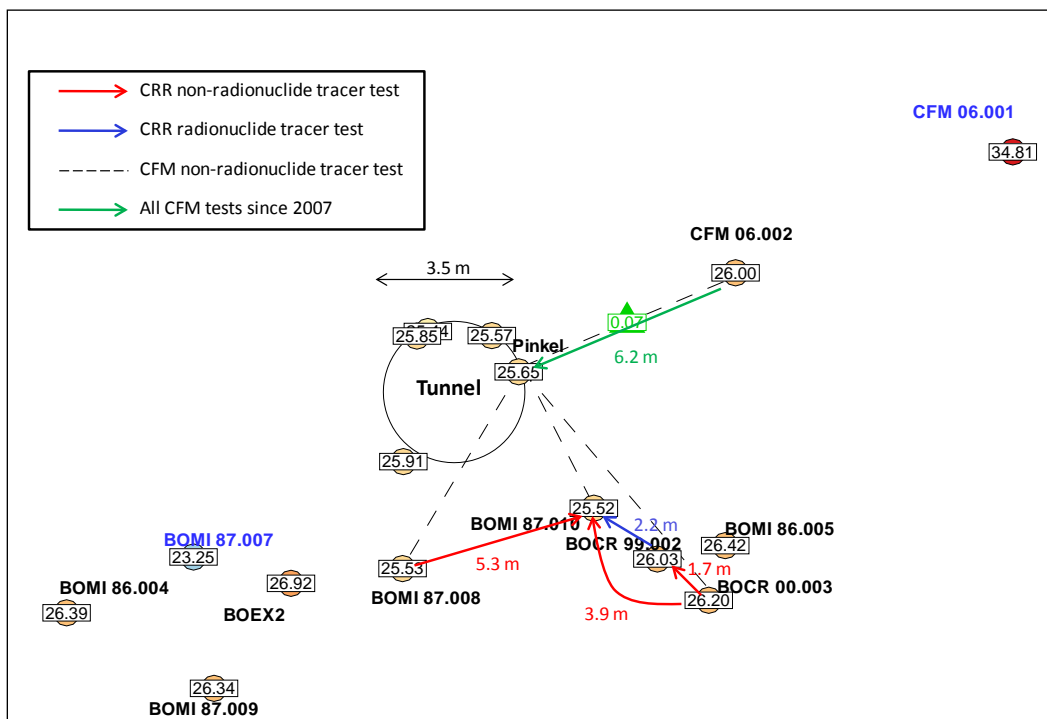

Figure 3.3-4 CFM field test bed at Grimsel Test Site: Borehole layout and test locations for all tracer tests 2001-2012 (Reimus 2012).

The CFM project entered a new phase of testing in May 2014 with the emplacement of a radionuclide-doped bentonite plug into the same injection interval CFM 06.002 intersecting the flowing shear zone at the GTS. This experiment is called the Long-term In-situ Test, or LIT. In 2011, three smaller diameter boreholes, CFM 11.001, 11.002, and 11.003, were drilled through the shear zone in roughly a triangular pattern around CFM 06.002 to serve as near-field monitoring boreholes during the LIT. A plan view of the borehole configuration around 06.002 is shown in Figure 3.3-5. In addition to providing near-field

access for monitoring and sampling during the LIT, these boreholes will be used for injection of epoxy to provide stability for post-experiment overcoring of 06.002 through the shear zone over a diameter that encompasses the three smaller boreholes (shown as dashed lines in Figure 3.3-5). This overcoring will allow a careful post-mortem of the LIT to determine the disposition of both bentonite and radionuclides in the shear zone at the end of the experiment.

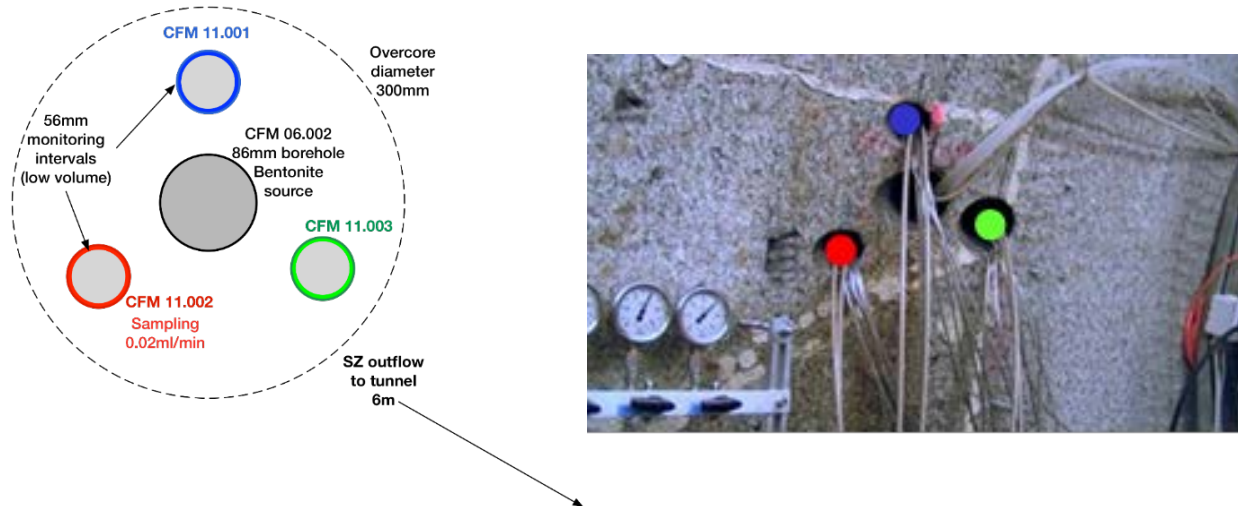

Figure 3.3-5 Plan view of the borehole configuration for the LIT (left) and photo showing the boreholes at the access tunnel wall (right).

In addition to the field activities conducted at the Grimsel Test Site, the CFM project includes many complementary activities aimed at helping achieve the R&D objectives listed at the beginning of this section. These activities include:

- Bentonite swelling and erosion experiments in various laboratory configurations, including artificial fractures, to better understand the processes of swelling and erosion that will occur in the bentonite-plug field experiment
- Laboratory sorption and desorption experiments of radionuclides and homologues onto both bentonite colloids and Grimsel fracture fill material
- Sorption/desorption experiments involving the competitive sorption and desorption of radionuclides/homologues in the presence of both colloids and fracture-fill material
- Colloid-facilitated radionuclide transport experiments in both crushed rock columns and in fractures in the laboratory.
- Laboratory experiments to improve detection and quantification methods for colloid analyses in field experiments, including possibly labeling the bentonite with a marker element
- Development of a bentonite swelling/erosion model
- Interpretive modeling of the laboratory experiments and the field tracer tests

The CRR and CFM experiments have been unique in that they evaluated colloid-facilitated radionuclide transport in a field setting intended to mimic a high-level nuclear waste repository scenario. Realizing the benefit of becoming a formal partner, in early 2012 DOE formally applied for partnership in the CFM Project and was accepted as a new partner in August 2012. Other current CFM project partners are from Germany (BGR, BMWi/KIT), Japan (JAEA, CRIEPI), Great Britain (NDA), Sweden (SKB), Republic of Korea (KAERI), Finland (POSIVA), and Switzerland (NAGRA). Partnership gave DOE and affiliated National Laboratories exclusive access to all experimental data generated by CFM. More importantly, it allowed UFD researchers to work collaboratively with international scientists in ongoing experimental and modeling studies, and it involves them in the planning of new experimental studies to be conducted in the future. Like the Mont Terri Project, this type of international collaboration goes beyond the mostly modeling focus of DECOVALEX.

In contrast to both the DECOVALEX project and the Mont Terri project, which comprise a range of experiments covering a wide spectrum of relevant R&D issues, the CFM has a relatively narrow focus, i.e., colloid-facilitated radionuclide migration. In part because of this narrow focus and the comparably high membership fee relative to other international initiatives, DOE decided in 2015 to cancel its participation in the CFM Project. However, even without an official membership in the project, UFD researchers from Los Alamos National Laboratory, USA (LANL) and Lawrence Livermore National Laboratory, USA (LLNL) continue to collaborate with their international partners in CFM. For example, LANL performed interpretative analysis of CFM field measurements in FY16 (Section 6.2.3.2). A comprehensive synthesis of the current state of knowledge of colloid-facilitated radionuclide transport from a nuclear waste repository risk-assessment perspective is given in a recent overview report by Reimus et al. (2016) (Section 6.2.3.1). The report draws heavily on findings from the extensive and carefully controlled set of colloid-facilitated solute transport experiments conducted at GTS.

3.3.1.2 Colloid Formation and Migration Summary

Benefits of Participation:

- Access to experimental data from a **suite of past, ongoing, and future experiments** on colloid-facilitated migration at Grimsel, more narrow focus than other initiatives (Note the CFM membership does not provide access to other experiments at Grimsel)
- Opportunity to **participate directly in international research groups that conduct, analyze, and model** migration experiments (more direct involvement than DECOVALEX)
- Opportunity for participating in and steering ongoing or planned experiments as well as **conducting own experiments**

Status of Participation:

DOE formally joined the CFM Project in August 2012. UFD researchers were involved in the interpretation and analysis of several colloid-facilitated tracer tests and conducted batch and column transport experiments to refine a colloid-facilitated transport model and to provide insight into potential colloid-facilitated transport of Cs isotopes in a crystalline rock repository (Section 6.2.3). DOE ended its participation in the CFM project in December 2015, but continued informal collaboration with CFM partner organization. A comprehensive synthesis report by Reimus et al. (2016) summarizes the current state of knowledge of colloid-facilitated radionuclide transport as derived from CFM and other activities.

Outlook:

DOE discontinued its participation in the CFM project in 2015, in part due to resource constraints but also because the scientific focus of the CFM Project is narrower than other initiatives discussed in this section. Informal collaboration is expected to continue.

Contact Information:

DOE Contact:

Prasad Nair, DOE-NE

UFD Contact:

Jens Birkholzer (LBNL)

Paul Reimus (LANL)

CFM Contact:

Ingo Blechschmidt, Head of Grimsel Test Site, NAGRA, Switzerland

3.3.2 FEBEX Dismantling Project

3.3.2.1 Introduction to FEBEX Dismantling Project

The FEBEX heater test is a full-scale Engineered Barrier System (EBS) test that was operating under natural resaturation conditions for almost two decades (Figures 3.3-6). The overall objective of the heater test was to evaluate the long-term performance of the EBS and, to a lesser degree, of the near-field crystalline rock, with emphasis on the thermal evolution and resaturation of bentonite backfill surrounding a heated waste package. With heating initiated in 1997 and the heaters turned off in 2015, the FEBEX experiment was the longest running full-scale heater experiment in the world, providing a unique data set for the transient behavior of a heated repository. A fixed temperature of 100°C had been maintained at the heater/bentonite contact during this time, while the bentonite buffer had been slowly hydrating with the water naturally coming from the rock. As shown in Figure 3.3-6, the test comprised two individual heater sections, placed horizontally into a short tunnel at GTS. In total, 632 sensors of diverse types were installed in the clay barrier, the rock mass, the heaters, and the service zone to measure the following variables: temperature, humidity, total pressure, stress, displacement, and pore pressure.

Partial dismantling of the *in situ* test was carried out during 2002, after five years of heating. The first one of the two heaters was removed and the materials recovered (bentonite, metals, instruments, etc.) were analyzed to investigate the different types of processes undergone, while the second heater continued to operate (Figures 3.3-7). The samples recovered from this first heater experiment provided valuable information on the long-term condition of heated EBS materials (Lanyon et al. 2013). In FY15, about 13 years after the first partial dismantling, NAGRA launched the FEBEX Dismantling Project (FEBEX-DP), which removed the second heater and recovered relevant EBS and host rock materials. This provided a unique opportunity for analyzing samples from an engineered barrier and its components that underwent continuous heating and natural resaturation for 18 years. DOE joined the FEBEX-DP Project as one of the initial partners, together with NAGRA, SKB, POSIVA, ENRESA, CIEMAT, KAERI, OBAYASHI, ANDRA, RWM and SURAO.

In FY15, UFD researchers from LANL, LBNL, and Sandia National Laboratories, USA (SNL) participated in the test design and sampling plan development and conducted preliminary model predictions. In FY16, in close collaboration between several FEBEX-DP partners, samples collected

during the dismantling of second heater were analyzed for water content, dry density, pore water and mineralogical composition, and bacterial growth. Data synthesis and post-dismantling modeling analysis are currently ongoing. Detailed analyses of water content and dry density are available, but pore water and mineralogical composition data are expected to be available by the end of 2016. Hydrological characterization revealed that the bentonite away from the heater is fully saturated (see Figure 3.3-8), but the bentonite in the vicinity of second heater has not yet fully saturated—the gravimetric water content is around 17-19% and water saturation is about 80% near the heater (see Figure 3.3-8). These data provide relevant information on the saturation and hydration behavior of bentonite under realistic in situ conditions.

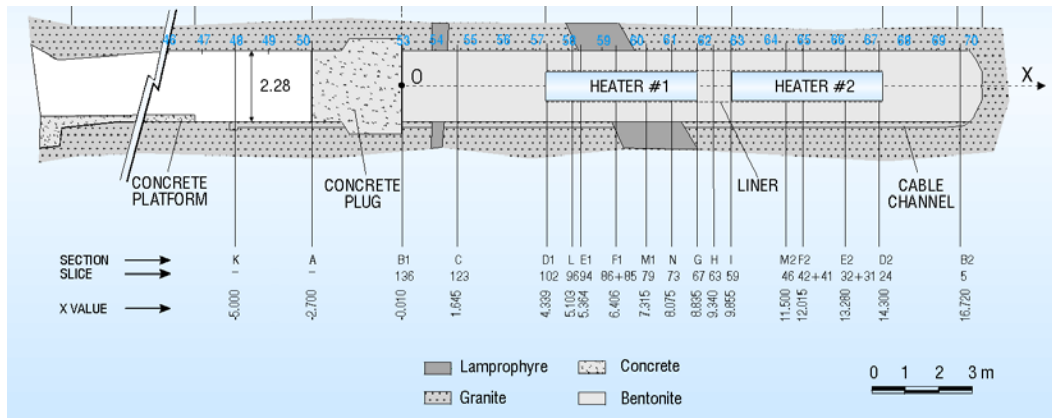

Figure 3.3-6 Schematic cross section of the FEBEX Test at Grimsel Test Site (NAGRA 2014).

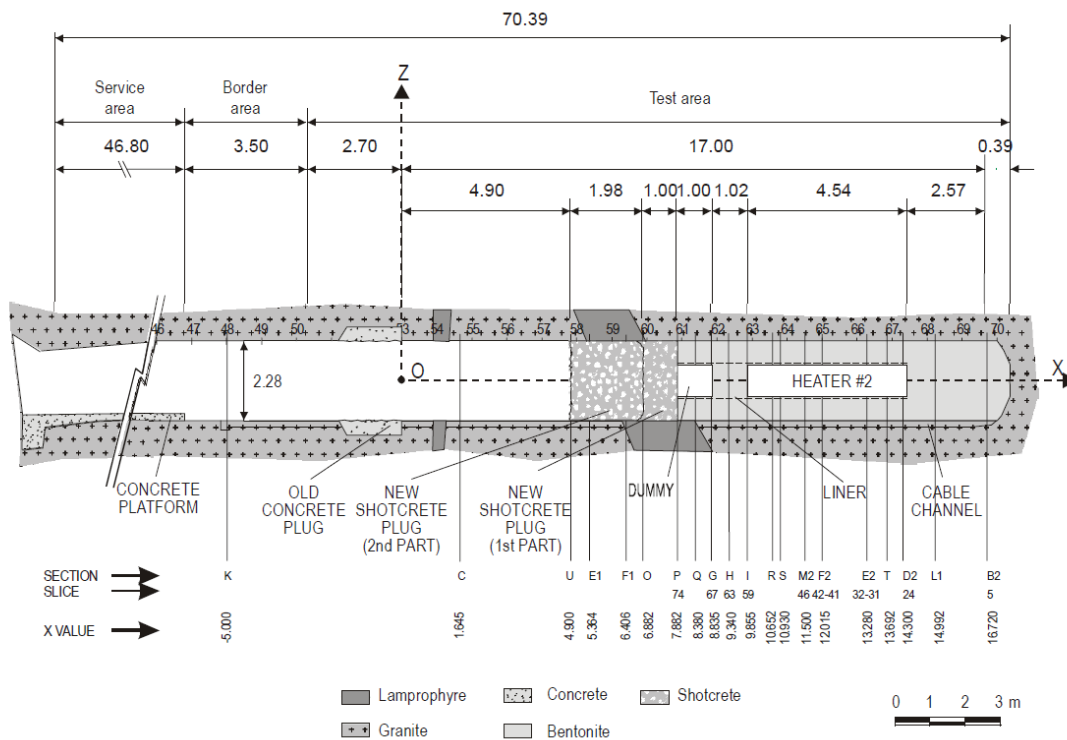

Figure 3.3-7 In situ test configuration following dismantling of Heater 1 (Huertas et al. 2005).

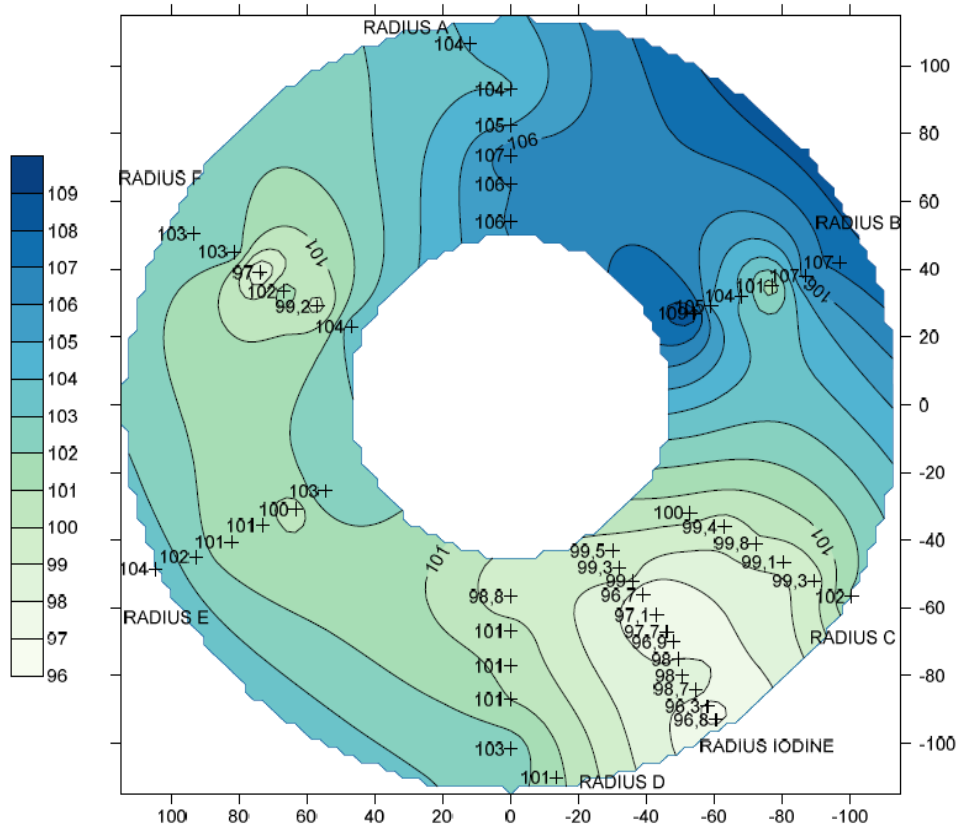

Figure 3.3-8 Spatial distribution of degree of saturation at section 37 (see Figure 3.3-10 for the position of section 37) (Zheng et al. 2016).

3.3.2.2 FEBEX-DP Objectives

The FEBEX-DP project is being conducted to provide data and to improve understanding of the long-term THMC performance of the EBS components and their interactions with the host rock. This will increase confidence in the models required for predicting the long-term evolution of the engineered barriers and how their natural environment affects these. The FEBEX-DP Project thus focuses on the following primary goals (Gaus and Kober 2014; NAGRA 2014) (Figure 3.3-9):

- Characterization of the key physical properties (density, water content) of the bentonite and their distribution
- Characterization of corrosion processes on instruments and coupons under evolving redox conditions and saturation states
- Characterization of mineralogical interactions at material interfaces and potential impacts on porosity
- Integration of monitoring results and modeling

These primary goals are realized by pursuing the following secondary objectives regarding the main elements of the experiment:

- Buffer and interfaces:
 - Obtain 3D insight into the water content and density distributions of the bentonite through extensive sampling.
 - Obtain insight into THM parameters and their evolution in time through comparison with the values of the first dismantling
 - Characterize pore water changes, modifications in the absorbed cations in the clays and potentially mineralogical alteration.
 - Microbiological characterization
 - Characterize interfaces with the liner, the heater, the embedded corrosion coupons and instrumentation and identify potential chemical interactions affecting the bentonite
- Instrumentation and metal coupons:
 - Recalibrate and correct the monitoring results if required, analyze their mechanical performance
 - Analyze corrosion products
- Plug and interfaces
 - Investigate the performance of the shotcrete at macro and micro level as well as the potential chemical changes occurring along the interfaces
- Granite host rock (service area and heated zone)
 - Investigate the rock properties of both zones, in particular the performance of the granite and the interfaces granite/bentonite.
- Heater and liner
 - Analyze potential corrosion, changes of position of the heater and deformations of the liner

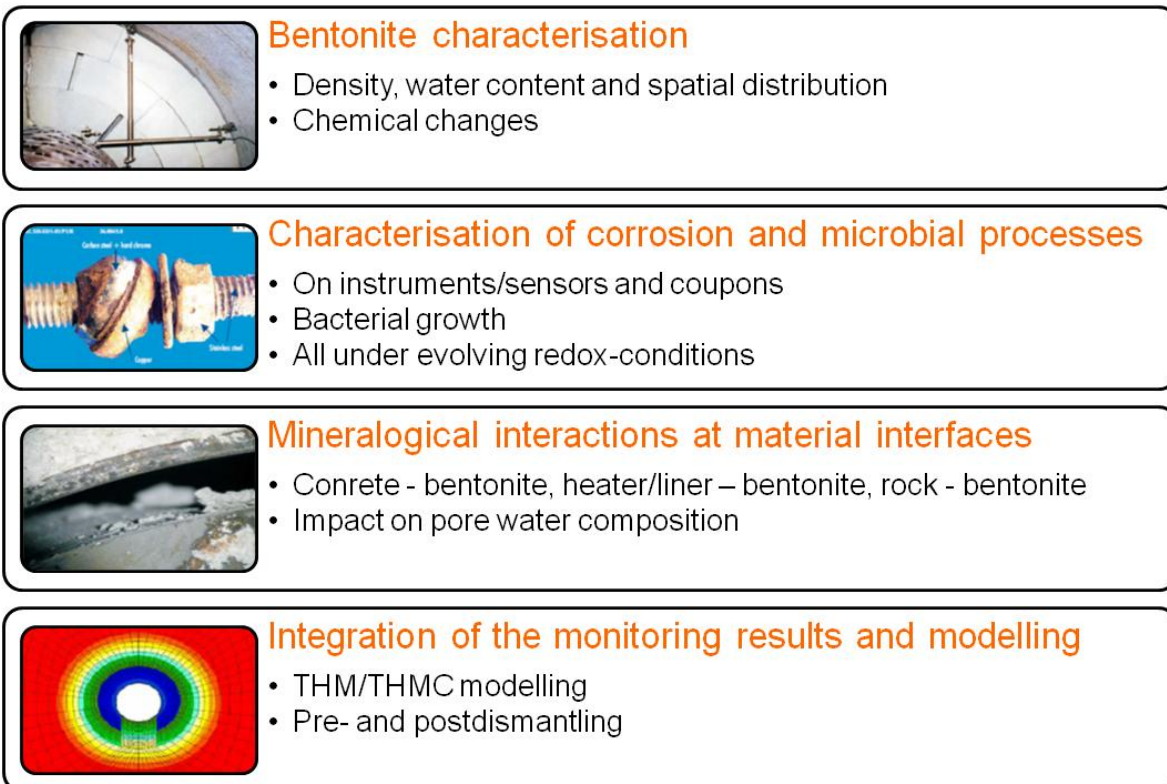

Figure 3.3-9 Primary goals of FEBEX-DP Project (NAGRA 2014).

3.3.2.3 *FEBEX-DP Activities and Timeline*

The FEBEX-DP project officially started with a kick-off meeting held June 10, 2014, in Thun, Switzerland. The project was originally scheduled to finish by the end of 2016, but might be extended for one more year as the delivery of reports that document project findings was delayed. The FEBEX-DP project includes the following activities (Gaus and Kober 2014):

Pre-dismantling modeling:

Pre-test modeling was conducted by a few international modeling groups to evaluate the predictive capability of THM and THC models regarding the long-term behavior of the EBS components. The THM models were developed by the Technical University of Catalonia to analyze the potential impact of switching off the heaters on the stress, pore pressure and relative water content in the EBS and granite. Preliminary THC models have been developed by LBNL to provide a scope of the geochemical changes after the dismantling of Heater 2 (Zheng et al. 2015).

Fieldwork related to the dismantling:

A final dismantling plan was developed in January 2015. Figure 3.3-10 shows the configuration of the dismantling sections during the dismantling of Heater 2. In February 2015, drilling was conducted through the concrete plug and parts of the bentonite to get access to the heater test area, and in about two weeks of dismantling, the dismantling crew retrieved several overcores with intact shotcrete/bentonite interface (Figure 3.3-11). Then the concrete plug was demolished starting April 8, 2015 until April 16, 2015. On April 24, 2015, the heater was switched off, after 6630 days of operation. The sampling on the first bentonite section (Section 36 in Figure 3.3-10) started on May 11, 2015. Sampling of all other sections was finished on August 6, 2015. Figure 3.3-12 shows an example of several core samples drilled out of one dismantling section, in this case section 62. Details about the dismantling of the second heater are given in Garcia-Sineriz et al. (2016). The samples were distributed to partners of FEBEX-DP for THMC and biological characterization and further experimental study, and most reports describing these collaborative studies are expected to be released by the end 2016 and early 2017.

Data synthesis and post-dismantling modeling:

Starting in early FY16, FEBEX-DP partners carried out laboratory analysis to characterize the hydrological, mechanical and chemical properties bentonite samples and some testing results were available in the second half of FY16. Post-dismantling modeling was conducted by UFD scientists to interpret these data (Zheng et al. 2016). In addition, laboratory experiments on FEBEX bentonite that focus on studying the micro-structure of bentonite were also conducted by UFD in FY16 (Zheng et al. 2016; Jove-Colon 2016). In FY17, post-dismantling modeling will continue, which will be centered on analyzing chemical data (scheduled to be available by the end of 2016) and refining chemical models. UFD R&D activities related to FEBEX-DP are further summarized in Section 6.1.2.

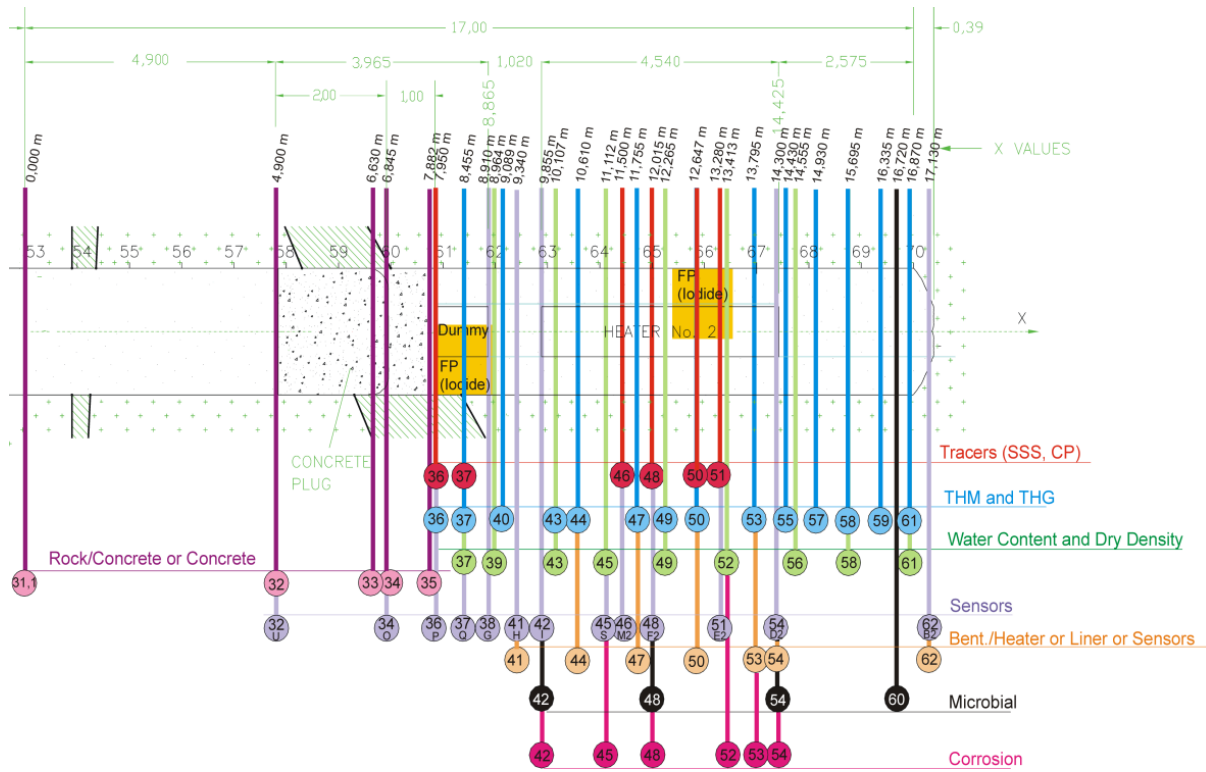

Figure 3.3-10 Sampling cross-sections (numbers in circles are cross-section numbers) for FEBEX-DP Project (NAGRA 2014).



Figure 3.3-11 An overcore that preserves the interface between shotcrete and bentonite (Zheng et al., 2016).



Figure 3.3-12 The front of dismantling section 62 with the core samples taken for microbiological studies, the blue bar prevents the partially detached bentonite from collapsing (Zheng et al., 2016).

3.3.2.4 FEBEX-DP Summary

Benefits of Participation:

- Access to experimental samples and laboratory investigations from a **long-term heater experiment** with focus on engineered barrier components, more narrow focus than other initiatives (Note that FEBEX-DP membership does not provide access to other experiments at Grimsel)
- Opportunity to **participate directly in international research groups that analyze samples and conduct modeling work** on coupled THM and THC behavior (more direct involvement than DECOVALEX)
- Opportunity for **designing sampling plans** as well as **conducting own laboratory experiments**

Status of Participation:

DOE joined the FEBEX-DP Project in 2014 as one of the initial partners. UFD researchers have participated in the test design and sampling plan development, and will continue working on the post-dismantling modeling and experimental studies. In FY15, the dismantling operation of the FEBEX test bed was successfully finalized and has provided valuable core samples for further analysis, testing and modeling. A pre-dismantling THC model was developed to predict the moisture content and concentrations of major elements in pore water and mineralogical change (Zheng et al. 2015). In FY16, the THC model was extended to THMC models and mechanical processes were simulated using both linear swelling model and dual structure BExM. LBNL scientists also conducted a series of synchrotron X-ray microCT (SXR- μ CT) examinations of the microstructure of bentonite samples. Fracture networks for each sample were obtained and quantified (Zheng et al. 2016). Another microscopic characterization

was carried out by SNL using SEMBSEI/EDS and micro-XRF to analyze FEBEX-DP bentonite-shotcrete overcore samples, which revealed that much of the reaction in this region appears to be confined to the shotcrete phase and little or no alteration is experienced in the bentonite (Jove-Colon 2016). See summaries of UFD R&D activities related to FEBEX-DP in Section 6.1.2.

Outlook:

The FEBEX-DP Project, which was originally scheduled to finish by the end of 2016, will likely be extended for one more year to allow for more analysis and synthesis modeling, in which case DOE will extend its membership in FEBEX-DP until the end of 2017. UFD researchers will remain involved in the post-dismantling analysis and modeling. Specifically, LBNL scientists will improve their fully coupled THMC models by incorporating additional coupling process (thermal osmosis) and revising the permeability-porosity relationship, such that the THMC model can best represent the observed behavior. Meanwhile, the chemical model will be fine-tuned, especially regarding redox condition evolution in the bentonite barrier and bentonite-canister interaction, and evolution of gases such CO₂, CH₄ and H₂. If the budget allows, UFD researchers will also conduct additional sample analysis, such as SXR- μ CT scanning for more samples at different locations to find statistically defensible relationships between microstructure and physical parameters.

Contact Information:

DOE Contact:

Prasad Nair, DOE-NE

UFD Contact:

Jens Birkholzer (LBNL)

Carlos Jove-Colon (SNL)

Liang Zheng (LBNL)

CFM Contact:

Irina Gaus and Florian Kober, NAGRA, Switzerland

3.3.3 Other Experiments at Grimsel Test Site, Switzerland

3.3.3.1 HotBENT – A Proposed High-Temperature Heater Test

Several international disposal programs have recently initiated investigating if clay-based barriers can withstand temperatures higher than the 100 °C threshold for bentonite performance usually assumed in advanced repository designs. For example, the UFD campaign has investigated the feasibility of direct geological disposal of large spent nuclear fuel canisters currently in dry storage (Hardin et al. 2014), which would benefit from much higher emplacement temperatures. The performance of bentonite barriers in the <100 °C temperature range is underpinned by a broad knowledge base built on laboratory and large-scale in-situ experiments. Bentonite parameter characterization above 100°C is sparser (especially for pelletized materials); although up to about 150 °C no significant changes in safety-relevant properties are indicated. At temperatures above 150 °C, it is possible that a potentially detrimental temperature-driven physicochemical response of materials (cementation, illitization) may occur, the characteristics of which are highly dependent on, and coupled with, the complex moisture transport processes induced by strong thermal gradients. The impact of such complex processes on the performance of a repository cannot be realistically reproduced and properly (non-conservatively) assessed at the smaller laboratory scale. Such an assessment needs to be conducted by large in-situ experiments in underground research

laboratories (URLs), where the most relevant features of future emplacement conditions can be adequately reproduced.

Potential options for a targeted high-temperature experiment (150 °C to 200 °C) in a fractured rock environment are currently being considered under the leadership of NAGRA with several international partners, including DOE (Vomvoris et al. 2015). In FY16, NAGRA proposed the so-called HotBENT experiment, a full-scale high-temperature heater test using the well-characterized FEBEX drift at the Grimsel Test Site. The benefit of such a large-scale test, accompanied by a systematic laboratory program and modeling effort, is that the temperature effects can be evaluated under realistic conditions of strong thermal, hydraulic and density gradients, which cannot be reproduced in the laboratory. This will lead to improved mechanistic models for the prediction of temperature-induced processes, including chemical alteration and mechanical changes, which can then be used for performance assessment (PA) analysis of high-temperature scenarios. The key question is whether higher repository temperatures would trigger mechanisms that compromise the various barrier functions assigned to the engineered components and host rock. If the barrier function is (partially) compromised, PA analysis can evaluate whether reduced performance of a sub-barrier (or parts thereof) would still give adequate performance.

In FY16, NAGRA held two planning meetings to discuss the interest of potential partners in the project and to develop a plan/design for the HotBENT project. Potential partners of HotBENT project proposed a modular design with several test modules (Figure 3.3-13) that would differ mainly in terms of type of bentonite and canister, temperature range, design with/without concrete liner, etc. Meanwhile, a small-scale “Hot Mock-up” test was proposed by SURAO, the Czech waste management agency (Kober 2016), which would greatly complement the full-scale HotBENT experiment. In FY17, the design of experiment should be finalized, and, if enough international partners join the project, the heater test is expected to start in 2018. LBNL has very actively participated in the project since the very beginning and will conduct scoping calculation in FY17 to facilitate the final design of the experiment. Potential HotBENT partners include NAGRA, GRS, SURAO, NUMO, RWM, and SKB. DOE’s participation in this new collaboration effort could be very beneficial; substantial cost savings would be achieved in the design of a repository if HotBENT demonstrates that the maximum temperature of bentonite backfill can be raised without drastic performance implications.

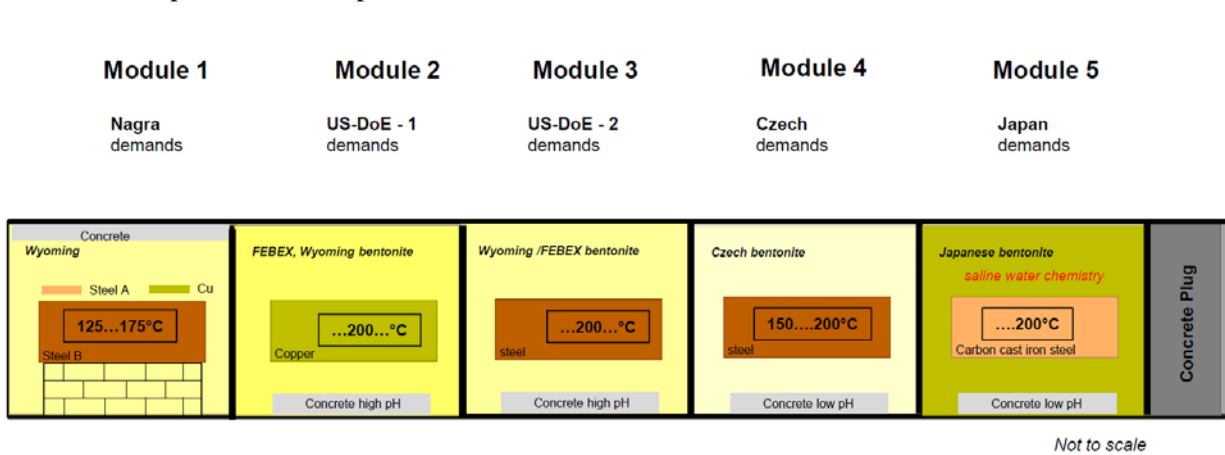

Figure 3.3-13 Design modules for HotBENT from partners of the project (Kober 2016).

3.3.3.2 Other Experiments at GTS

Besides the CFM, the FEBEX-DP Project and the proposed HotBENT test, other collaboratively conducted experiment at the Grimsel Test Site (GTS) may also be of interest to DOE/UFD. Worth considering is perhaps the Gas-Permeable Seal Test (GAST) (Focus: EBS), which looks at bentonite-sand mixtures for increased gas transport capacity (to mitigate pressure buildup from gas generation) within the backfilled underground structures, without compromising the radionuclide retention capacity of the engineered barrier system (Figure 3.3-14). Other options include the (1) Long-Term Cement Studies (LCS) project (Focus: EBS), which has the overall aim to increase understanding of the cement-leachate interaction effects in the repository near field and geosphere, (2) the Long-Term Diffusion (LTD) project (Focus: NBS), which has the overall aim to provide quantitative information on matrix diffusion of radionuclides in fractured rock under *in situ* conditions over long time scales, and (3) the experiments on gas production and migration conducted within the European Union project FORGE (Fate of Repository Gases). The possibility of participation, and the conditions of being involved in these latter three projects, requires further clarification.

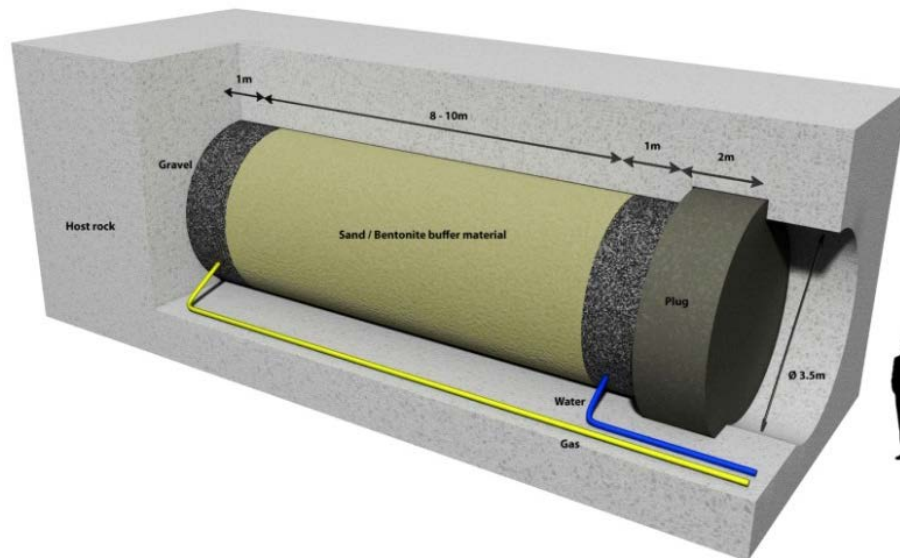

Figure 3.3-14 GAST Experiment at Grimsel Test Site: Schematic picture of repository seal design with 8–10 m long sand/bentonite plug in between two gravel packs and a concrete plug for reinforcement (from <http://www.grimsel.com/gts-phase-vi/gast/gast-introduction>).

3.4 SKB Task Forces

3.4.1 Introduction to SKB Task Forces

SKB, the Swedish Nuclear Fuel and Waste Management Company, has been organizing task forces as a forum for international organizations to interact in the area of conceptual and numerical modeling of performance-relevant processes in natural and engineered systems. There are two task forces: the Groundwater Flow and Transport (GWFTS) Task Force initiated in 1992, and the Engineered Barrier Systems (EBS) Task Force initiated in 2004. The GWFTS Task Force is led by Björn Gylling of SKB. The EBS Task Force has two parts, one for THM processes (led by Antonio Gens from UPC in Spain), and the other for THC processes (led by Urs Maeder of University of Bern). Different modeling tasks are being addressed collaboratively, often involving experiments carried out at SKB's Äspö Hard Rock Laboratory (HRL) situated in crystalline rock near Oskarshamn in Sweden. The Äspö HRL consists of a main tunnel that descends in two spiral turns to a depth of 460 m, where various tests have been and are being performed in several side galleries and niches (Figure 3.4-1). SKB collaborates closely with the Finnish repository program; thus in some cases, SKB Task Force modeling tasks are also related to experiments conducted at the Onkalo URL in Finland (Section 4.6).

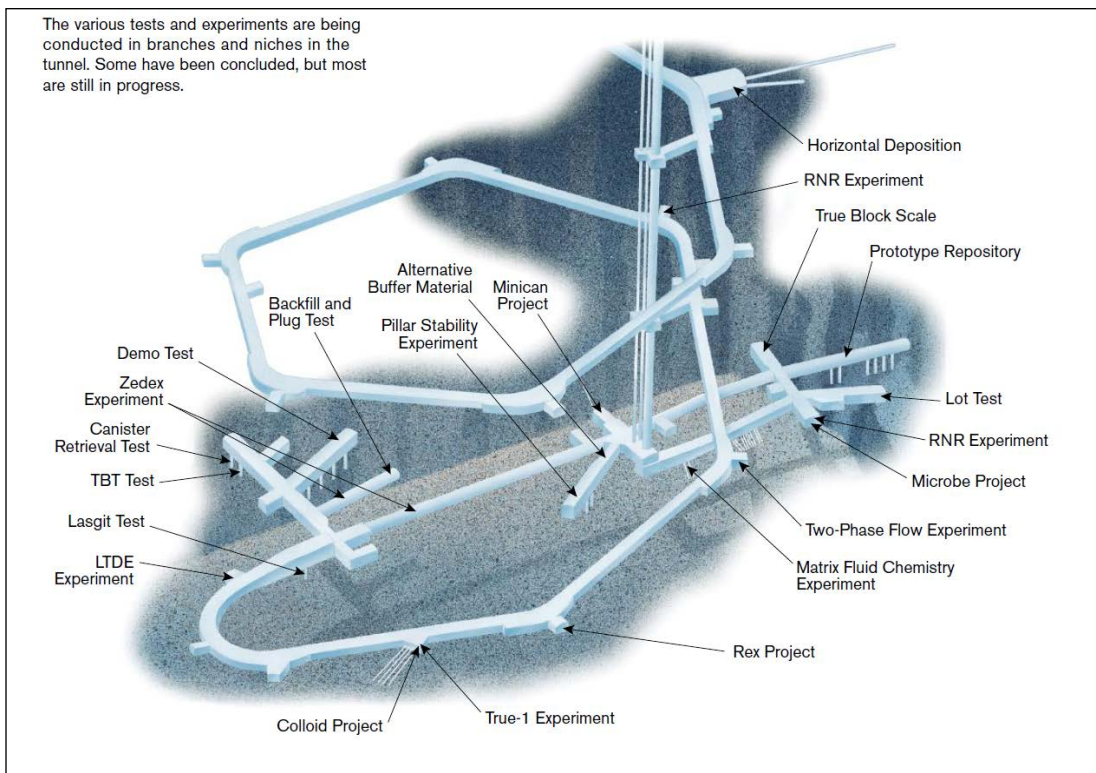

Figure 3.4-1 Layout of Äspö HRL and location of main experiments (Birkholzer 2012).

As the other collaborative initiatives introduced earlier in this report, participation in SKB in the Task Forces requires a formal membership agreement. Each participating organization is represented by a delegate; the modeling work is performed by modeling groups associated with these organizations (not unlike the DECOVALEX framework). The task forces meet regularly about once to twice a year. Task

force members interact closely with the principal investigators responsible for carrying out experiments at Äspö HRL. Much emphasis is put on building of confidence in the approaches and methods in use for modeling of groundwater flow and migration, as well as coupled THM and THC process, in order to demonstrate their use for performance and safety assessments.

In the past years, DOE/UFD's liaison for international collaboration frequently interacted with SKB representatives to evaluate the condition and benefits of joining one or both task forces. UFD representatives participated in the GWFTS Task Force meeting in April 24-25, 2012, in Oskarshamn in Sweden and participated in a joint meeting of the GWFTS and EBS Task Forces held in Lund, Sweden, November 27-29, 2012. DOE eventually joined both task forces in January 2014 and hosted a joint task force meeting in Berkeley in December 2014. Other participating organizations in the GWFTS and/or EBS Task Forces are SKB, POSIVA, KAERI, CRIEPI, JAEA, NAGRA, BMWi/KIT, RWM, NWMO, and SURAO.

In past years (FY14 and FY15), UFD researchers have been actively engaged in the GWFTS task force and have conducted simulation work supporting the interpretation of the Bentonite Rock Interaction Experiment, Äspö HRL, Sweden (BRIE) experiment (Section 3.4.2.1). This year, the focus has shifted to a new GWFTS modeling task, which involves diffusion and sorption experiments conducted at the Äspö HRL, Sweden, and the Onkalo URL, Finland. In regards to the EBS Task Force, DOE/UFD is going through a planning and selection process regarding future work as several new task proposals are being developed and discussed.

3.4.2 GWFTS Task Force

The main objective of the GWFTS Task Force is to develop and apply appropriate methods for investigating flow and transport in fractured crystalline rock, in particular to obtain better understanding of the retention of radionuclides transport in crystalline rock, and to improve the credibility of simulation models. The task force also provides a platform for interaction in the area of conceptual and numerical modeling of groundwater flow and solute transport in fractured rock.

For the past few years, the main modeling task conducted in the GWFTS task force was Task 8: Modeling of the BRIE at Äspö HRL. The BRIE experiment is a joint task shared between the GWFTS and the EBS Task Forces. The main objective of the BRIE experiment was to enhance the understanding of the hydraulic interaction between the fractured crystalline rock at Äspö HRL and the unsaturated bentonite used as backfill. The experiment was subdivided into two parts: the first part involving the selection and characterization of a test site and two central boreholes, the second part handling the installation, monitoring, and later overcoring of the bentonite-rock interface. Modeling groups seek (a) to gain a better understanding of water exchange at the bentonite-rock interface, and (b) to obtain better predictions of bentonite wetting in a fractured rock mass. Task 8 has been ongoing for several years and is now winding down. As mentioned above, a new Task 9 has recently been introduced, which involves modeling of two diffusion/sorption experiments: the Long Term Diffusion Experiment at Äspö HRL and the REPRO (Rock Matrix Retention Properties) Experiment at Onkalo URL in Finland. More details on Tasks 8 and 9 are given below.

3.4.2.1 Task 8: Bentonite Rock Interaction Experiment (BRIE)

The main objective of the BRIE experiment was to enhance the understanding of the hydraulic interaction between the fractured crystalline rock at Äspö HRL and the initially unsaturated bentonite used as backfill (SKB 2011b). The setup is aligned with the Swedish concept of emplacing canisters into vertical deposition holes that are subsequently backfilled (Figures 3.4-2 and 3.4-3). The experiment was

subdivided into two main parts: the first part describing the selection and characterization of a test site and two central boreholes, the second part handling the installation and extraction of the bentonite buffer. Initial characterization resulted in a deterministic description of the fracture network at a small scale (10 m). This includes all identified fractures and the water-bearing part of the fractures. BRIE has its focus on the common boundary between the bentonite clay and the water-bearing fractures in the near-field host rock, and as mentioned above, was a modeling task jointly undertaken by the Task Force on Groundwater Flow and Transport and the Task Force on Engineered Barrier Systems. In FY14 and FY15, UFD researchers from Los Alamos National Laboratories participated in the modeling analysis of the BRIE experiment (Viswanathan et al. 2015).

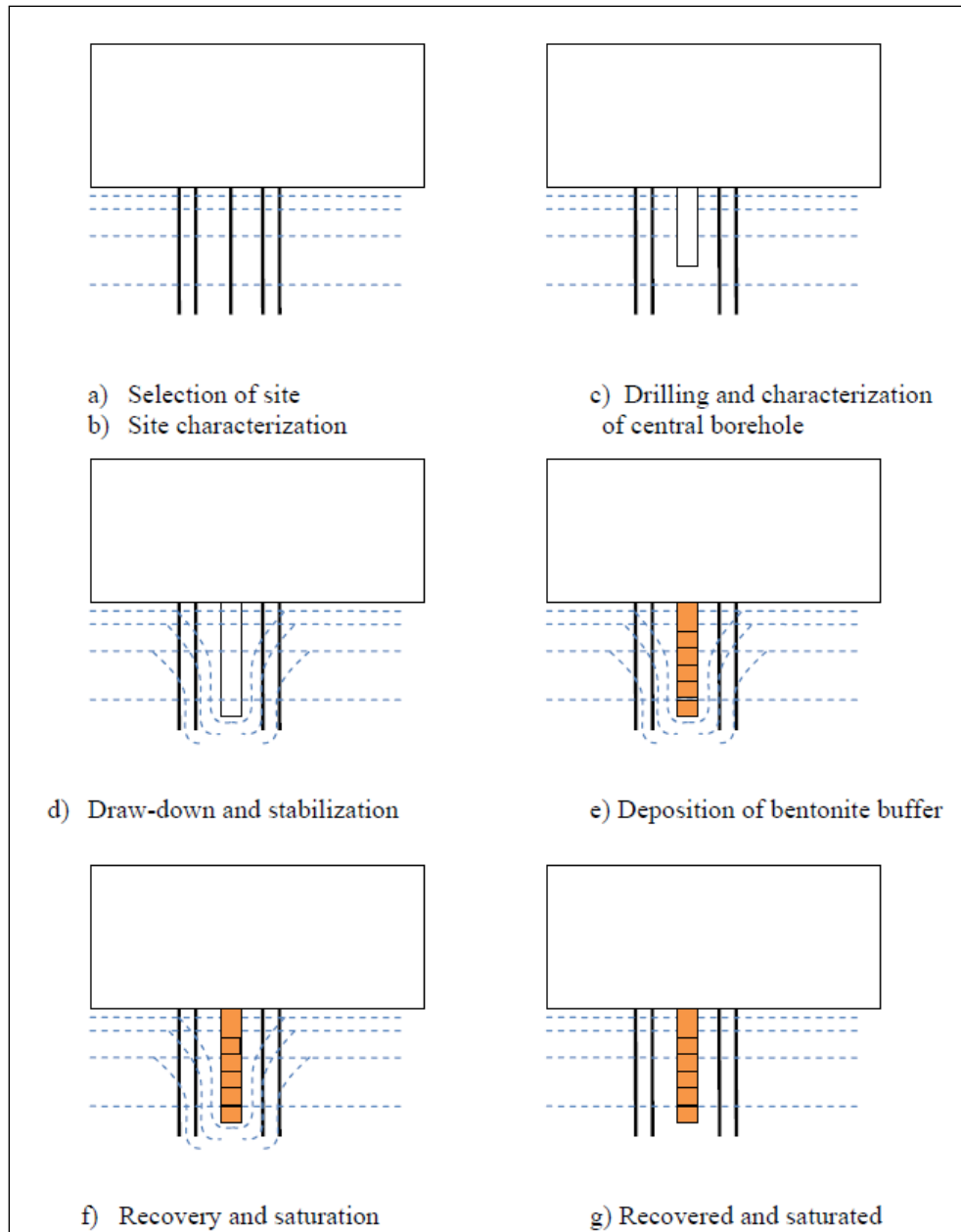

Figure 3.4-2 Schematic presentation of the stages of the BRIE Experiment at Äspö HRL (Bockgård et al. 2012).



Figure 3.4-3 BRIE Experiment at Äspö HRL: The test niche and five boreholes (distance 1.5 m) used for initial characterization and selection of BRIE site (SKB 2011b).

3.4.2.2 Task 9: Modeling Two Diffusion and Sorption Experiments in Crystalline Rock

This proposed task focuses on the modeling of coupled matrix diffusion and sorption in heterogeneous crystalline rock matrix at depth. This is done in the context of inverse and predictive modeling of tracer concentrations measured in two *in-situ* experiments performed within LTDE-SD at the Äspö HRL in Sweden as well as within the REPRO project at Onkalo URL in Finland (see Section 4.6), focusing on sorption and diffusion. The ultimate aim is to develop models that in a more realistic way represent retardation in the natural rock matrix at depth. Researchers from Los Alamos National Laboratory are participating in Task 9 as described in Section 6.2.2.

LTDE-SD, the Long-Term Diffusion Sorption Experiment was completed in 2010. The experiment was designed to examine diffusion and sorption processes in both matrix rock and a typical conductive fracture identified in a pilot borehole. A telescoped large-diameter borehole was drilled subparallel to the pilot borehole, in such a way that it intercepts the identified fracture some 10 m from the tunnel wall, and with an approximate separation of 0.3 m between the circumferences of the two boreholes (Figure 3.4-4). A cocktail of nonsorbing and sorbing tracers was circulated between the boreholes in packed-off sections for a period of 6 ½ months, after which the borehole was overcored and the extracted rock analyzed for tracer penetration and fixation. The specific objectives of LTDE-SD were to:

- Obtain data on sorption properties and processes of individual radionuclides, and their effect on natural fracture surfaces and internal surfaces in the rock matrix.
- Investigate the magnitude and extent of diffusion into matrix rock from a natural fracture *in situ* under natural rock stress conditions and hydraulic pressure and groundwater chemical conditions.
- Compare laboratory-derived diffusion constants and sorption coefficients for the investigated rock fracture system with the sorption behavior observed *in situ* under natural conditions, and to evaluate whether laboratory-scale sorption results are representative also for larger scales.

The illustration in the lower right of Figure 3.4-4 shows the location of LTDE-SD in the Äspö HRL tunnel system. In the center of the figure, the local tunnel section is depicted together with the different boreholes drilled from the site. These boreholes include the LTDE-SD borehole and the closely located pilot borehole. These two boreholes intersect a water-conducting natural fracture at a distance of 11 m from the tunnel wall, which is the experiment's target fracture. The LTDE-SD borehole was drilled with different diameters, roughly described as follows. Up to the fracture plane the borehole has a large diameter and beyond the fracture plane a small diameter was used. This is simplistically illustrated in the lower left of Figure 3.4-4. The borehole is indicated by the solid black line and the intersected fracture is indicated by the curved blue line. Orange areas indicate packed-off volumes, whereas blue areas indicate volumes of the tracer cocktail. The red arrows symbolize in-diffusion of tracers from the large-diameter borehole through the fracture surface and into the underlying altered rock matrix. They also symbolize diffusion into the unaltered rock matrix from the small-diameter borehole. The dashed black line indicates the rock volume that was overcored at the end of the tracer test.

The tracers injected were Na-22, S-35, Cl-36, Co-57, Ni-63, Se-75, Sr-85, Nb-95, Zr-95, Tc-99, Pd-102, Cd-109, Ag-110, Sn-113, Ba-133, Cs-137, Gd-153, Hf-175, Ra-226, Pa-233, U-236, and Np-237. Tracer concentrations as well as other environmental parameters were monitored during the 200 days the tracer test progressed. After that the surrounding rock volume was overcored, and from the overcored volume a number of smaller drill cores were excavated, as illustrated on the left in Figure 3.4-5. Here the natural fracture surface is located on the right-hand side of the overcored rock volume. A large number of the core samples of Figure 3.4-5 were cut into subsamples as indicated to the right in Figure 3.4-5, enabling the obtaining of tracer penetration profiles. Tracer concentrations (or activities) in the rock were obtained by a number of analysis methods, including autoradiography on intact samples; direct activity measurements on intact and crush samples; and leaching or dissolution of intact and crush samples, followed by water phase measurements.

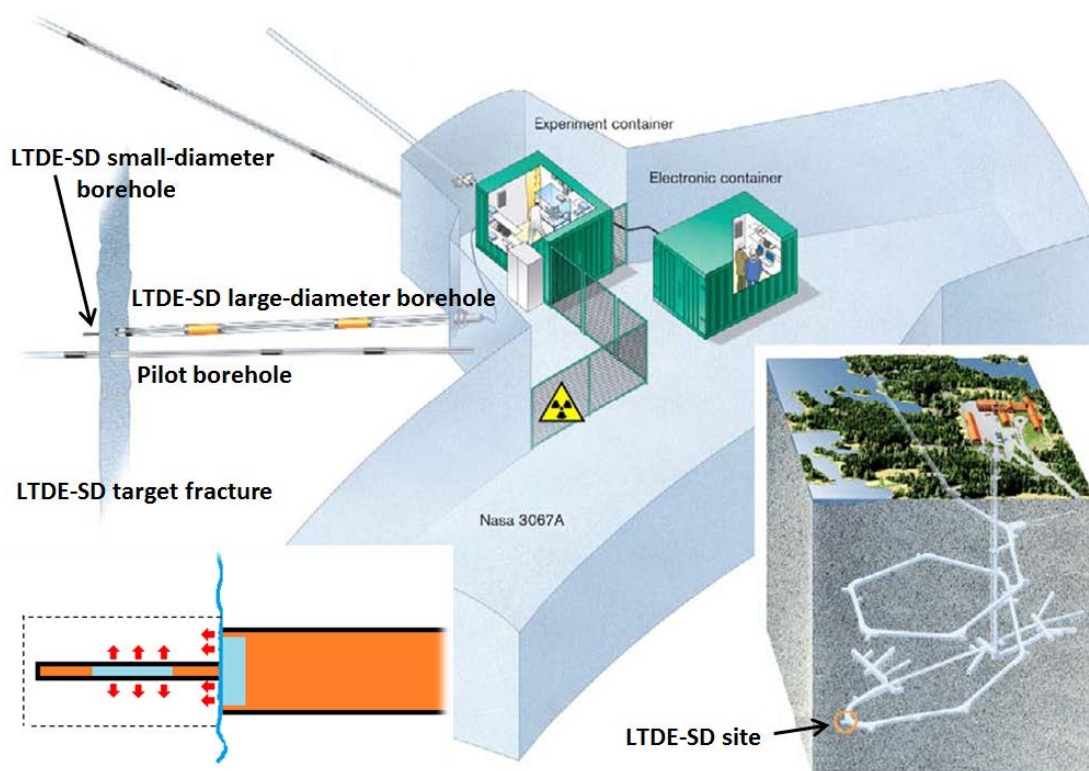

Figure 3.4-4 Schematic layout of LTDE-SD at Äspö HRL (SKB 2011a).

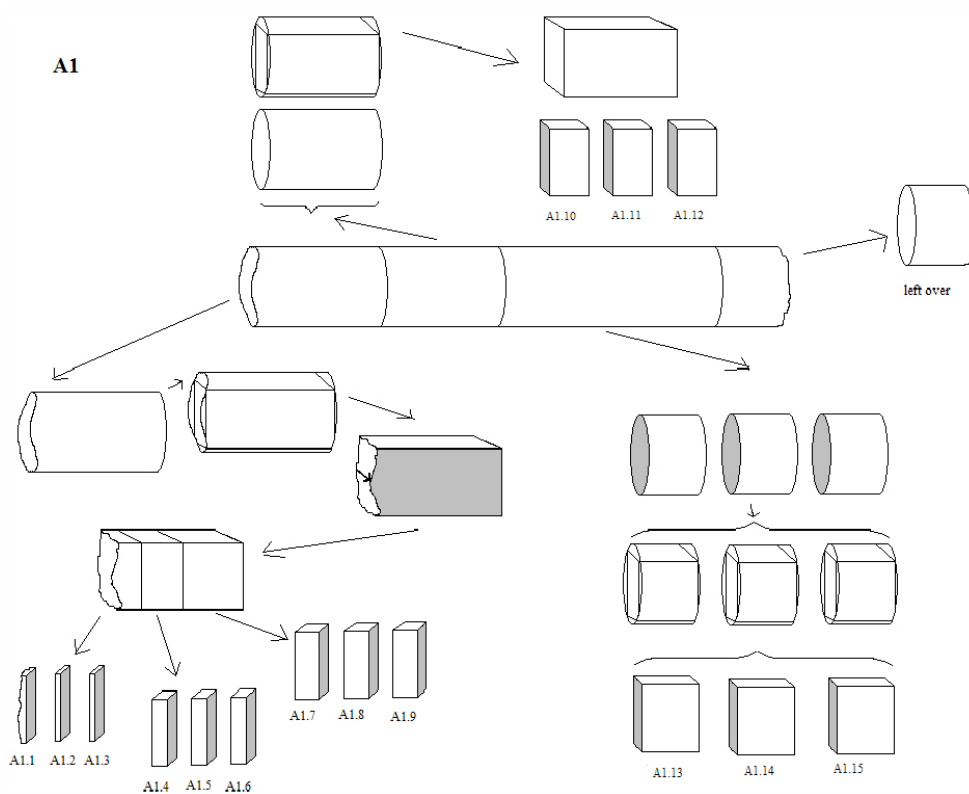
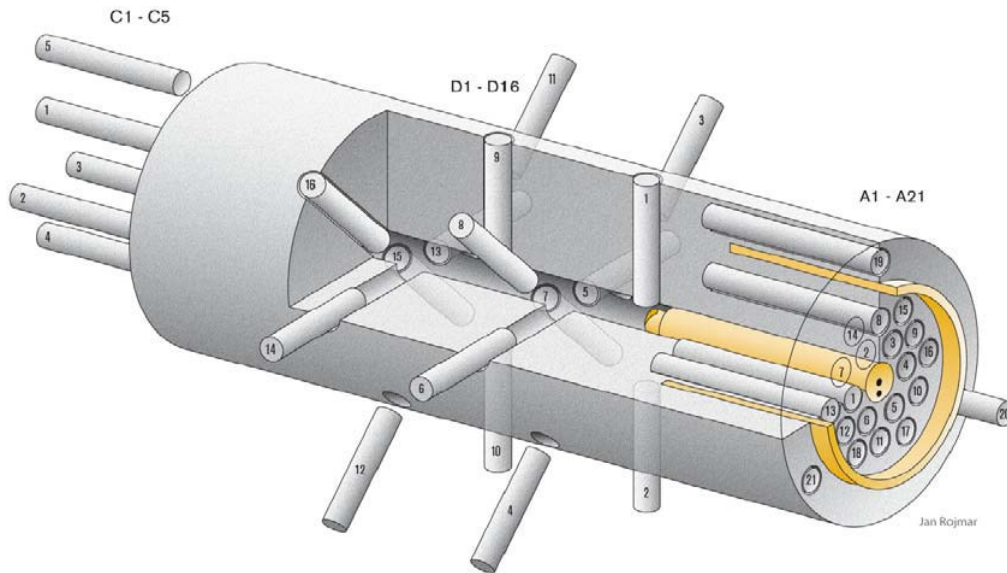

Figure 3.4-5 Illustration of the sampling of the overcored rock volume in LTDE-SD (SKB 2011a).

Results from the overcoring rock volume in LTDE-SD provide concentration profiles in the rock matrix that are not fully understood to date. Figure 3.4-6 shows experimental concentration profiles of two tracers compared to predictive model results, with obvious discrepancies in the curve shapes. These may be a result of heterogeneities in the rock matrix or may be related to inappropriate model assumptions related to Fickian diffusion or equilibrium sorption. One aim of Task 9 will be to increase realism in the diffusion-sorption predictions of the LTDE-SD.

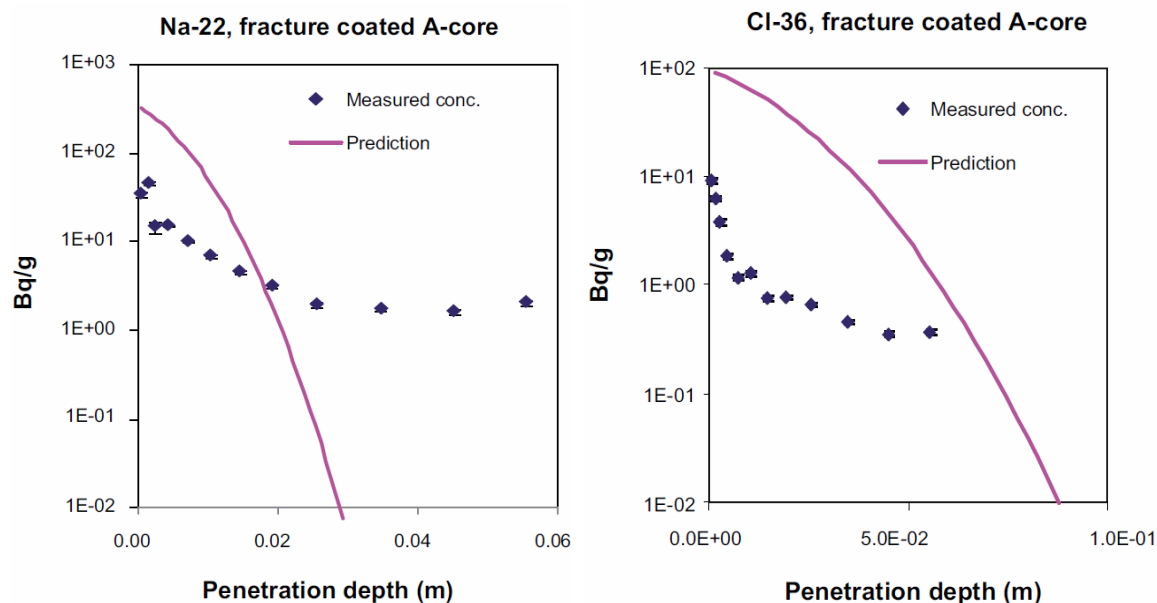

Figure 3.4-6 Results from the in-situ in-diffusion experiment LTDE-SD through a natural fracture surface. Modeled Na-22 and Cl-36 penetration profiles (solid curves) are compared to the measured profiles (diamonds). Na-22 activities in the rock matrix were obtained on intact or crushed rock slices and Cl-36 activities were obtained by leaching of intact or crushed slices (Viswanthan et al., 2016).

The REPRO experiments are the other important element of Task 9. REPRO involves a number of boreholes that have been drilled into the non-fractured rock matrix from a working niche at the Onkalo underground rock characterization facility, at about 400 m depth (see Figure 3.4-7). Borehole ONK-PP323 is utilized for the Water Phase Diffusion (WPDE) series of experiments, which are advection-diffusion-sorption tests. They are carried out between ~18-20 m from the tunnel wall. A 1.9 m long section has been packed off, and in this section a dummy has been placed. Its diameter is 54 mm whereas the borehole diameter is 56 mm, leaving a 1 mm gap between the borehole wall and the dummy. This gap is regarded as an artificial fracture of relatively well-defined geometry. A very low steady state water flow has been applied in this gap, directed towards the tunnel. This is achieved by injecting the water at the far end of the packed-off section, as shown to the upper right in Figure 3.4-7. In this water flow, the tracers HTO, Na-22, Cl-36, and I-125 were injected in WPDE-1, and HTO, Na-22, Cl-36, Sr-85 and Ba-133 in WPDE-2. Injection was made as a few hours long pulse at the far end of the experimental section. As the pulse travels with the water flow, its tracers diffuse into the rock matrix. As the pulse passes, the concentration gradients are reversed and the tracers diffuse out of the rock matrix and into the flowing water. To date, two experiments have been performed at different flow rates, WPDE-1 (20 $\mu\text{L}/\text{min}$) and WPDE-2 (10 $\mu\text{L}/\text{min}$). The tracer concentrations were measured in water flowing out of the experimental section, both by on-line Na(Tl)I-scintillation detection and by analyzing water samples in the laboratory. Breakthrough curves have been obtained over half a year and about one and a half a year for WPDE-1 and WPDE-2, respectively. Currently there are no plans for overcoring of the rock volume surrounding the experimental section.

Another REPRO experiment, referred to as Through Diffusion Experiment (TDE), will be carried out between three parallel boreholes situated perpendicular to each other, in 1 m long packed-off sections, at a distance of about 11 to 12 m from the tunnel wall. Borehole ONK-PP326 will be used as the injection hole and boreholes ONK-PP324 and ONK-PP327 as observation holes (see Figure 3.4-7, upper left corner). The distances between the boreholes are between 10 and 15 cm. Advective flow between the boreholes is foreseen to be insignificant, as the experiment takes place in a rock volume that lacks in water-bearing fractures. The tracers HTO, Na-22, Cl-36, Ba-133, and probably Cs-134 are planned to be injected. The decreasing and (expected) increasing tracer concentrations in the injection hole and observation holes, respectively, will be analyzed. This is done on extracted samples in the laboratory, by liquid scintillation counting and High Resolution x-ray spectroscopy (gamma measurements). Furthermore, on-line measurements will be performed in the injection hole and observation holes by a High Performance Germanium detector and a Na(Tl)I-scintillation detector, respectively. Tracer concentrations in the injection hole will be measured at a higher frequency at the first part of the experiment, while focus will be shifted towards analyzing breakthrough concentrations in the observation holes as the experiment progresses. Breakthroughs of non-sorbing tracers are foreseen within the timeframe of conducting Task 9, although unexpectedly low pore diffusivities may prevent this from happening. The tracers were chosen to make overcoring and analysis of tracer penetration profiles possible, although this option is presently not included in the REPRO planning. As the REPRO project is ongoing, it offers the possibility of both inverse and predictive modeling. The in-situ part of REPRO aims to tackle the topics of diffusion, sorption, anion exclusion, and rock matrix anisotropy. In addition, the laboratory has focused on small-scale rock characterization. This provides a wealth of input data that can be incorporated in the modeling.

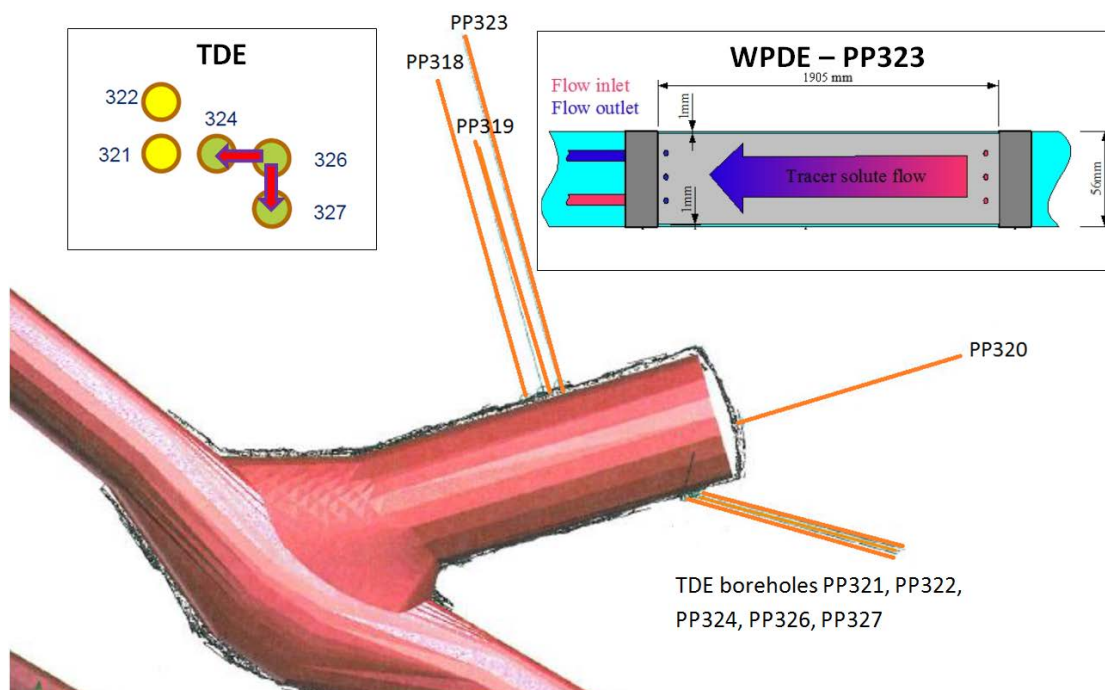

Figure 3.4-7 The REPRO Niche at the 401 m level at ONKALO, and the nine boreholes drilled from the niche. Borehole PP323 is utilized for WPDE-1&2, and boreholes PP324, PP326, and PP327 for TDE (Viswanathan et al., 2016).

3.4.3 EBS-THM Task Force

As mentioned above, the EBS Task Force essentially has two distinct focus areas, one on THM processes referred to as EBS-THM (led by Antonio Gens from UPC in Spain), the other on chemical processes referred to as EBS-C (led by Urs Maeder of University of Bern). The main objective of the EBS-THM Task Force is the development and application of general and effective tools for the advanced coupled THMC analysis of buffer and backfill materials, and their interactions with a saturated fractured host rock environment. Specific goals are as follows: (1) to verify the capability to model THM processes in unsaturated as well as saturated bentonite buffer and backfill materials, (2) to validate and further develop material models and computer codes by numerical THM modeling of laboratory and field tests and compare modeling results with measured results, and (3) to evaluate the influence of parameter variations, parameter uncertainties and model imperfections. The EBS-THM Task Force is currently in a transition phase. Three main modeling tasks in the EBS-THM task force that have been running for several years are winding down: the Homogenization Task, the Prototype Repository, and the BRIE experiment which is shared with the GWFTS Task Force (Section 3.4.2.1); at the same time, new tasks are being discussed, proposed and developed. The Homogenization Task and the Prototype Repository Task are briefly described below, followed by a review of possible future tasks in the EBS-THM Task Force.

3.4.3.1 Homogenization Task

SKB has been undertaking an experimental program with a series of laboratory experiments to better understand and quantify homogenization of bentonite backfill. Gaps and cracks may exist due to initial bentonite emplacement or due to long-term hydraulic and chemical erosion of bentonite (the latter refers the possibility of low-ionic strength waters affecting bentonite). Such heterogeneities can affect the bulk transport properties of the backfill and thus the isolation performance of the EBS. Therefore, these experiments are important to evaluate the fate of buffer/backfill upon hydration and the capacity for effective self-sealing and water saturation in the presence of these heterogeneities.

The Homogenization Task is a modeling task supporting the experimental program. Modeling teams developed predictive models for bentonite homogenization, which were then being tested in comparison to results from the experimental series. Figure 3.4-8 shows a typical experimental setup for a laboratory experiment as part of the Homogenization Task. This experiment was designed to investigate the swelling and potential self-sealing of an irregular cavity that was deliberately cut into a bentonite block in two diametrical positions as shown in the figure. Because these experiments involved the study of saturated bentonite, water for hydration was provided along the radial surfaces and in the cavities. Nine transducers for measuring swelling pressure and two for measuring suction were installed as shown in Figure 3.4-8. Experimental results showed that complete homogenization of the bentonite block incorporating the two cavities occurred after about 4 months, a result that then needs to be explained by the simulation models. UFD researchers are not currently active in this task.

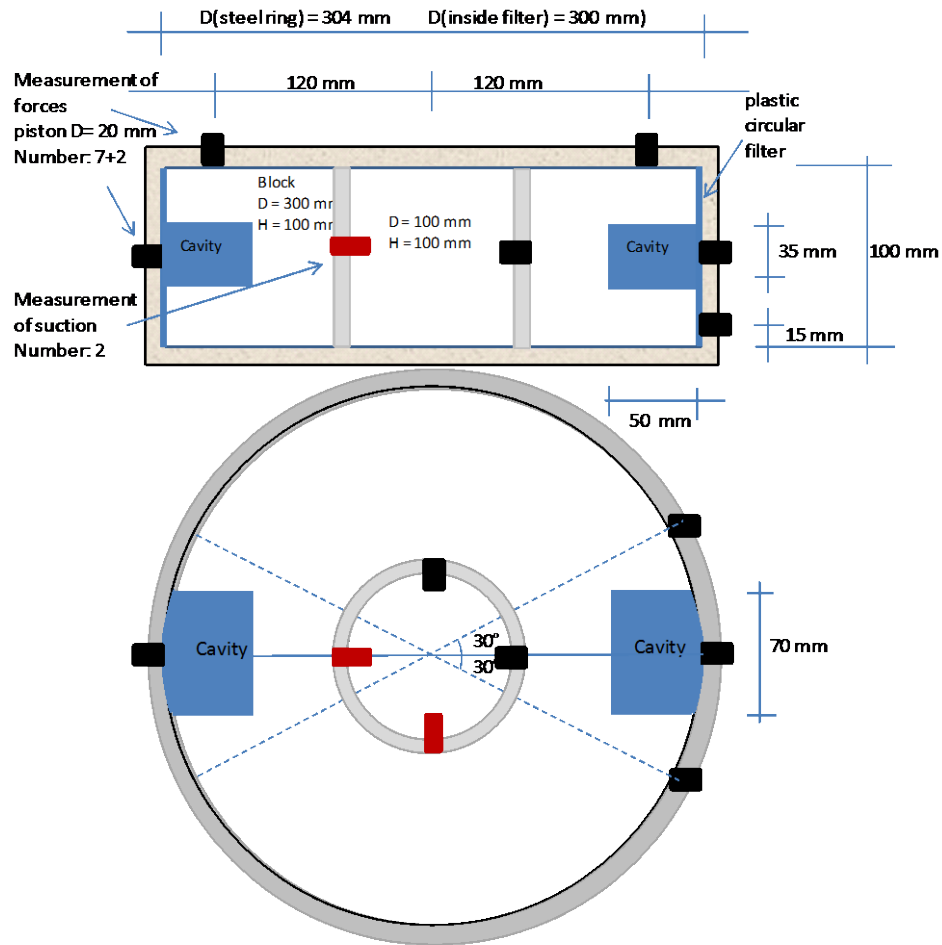

Figure 3.4-8 Top: Schematic view of device geometry used in the large-scale buffer homogenization experiments. Bottom: Photo of the device showing the lid, inlets, and sensors along with bentonite block (Börgesson et al. 2015).

3.4.3.2 Prototype Repository

In 2000, SKB started the planning and installation of a so-called Prototype Repository as a full-scale demonstration of the integrated function of the repository, and a reference for testing predictive models concerning individual components as well as the complete repository system. The test area is located in the innermost section of the TBM tunnel at Äspö HRL. The layout involves six deposition holes, four in an inner and two in an outer section—see Figure 3.4-9. Canisters with dimension and weight according to the current plans for the final repository, and with heaters to simulate the thermal energy output from the spent nuclear fuel, have been positioned in the holes and surrounded by bentonite buffer. The deposition holes were placed with a center distance of 6 m. This distance was evaluated considering the thermal diffusivity of the rock mass and the maximum acceptable temperature of the buffer. The deposition tunnel was backfilled with a mixture of bentonite and crushed rock (30/70). A massive concrete plug, designed to withstand full water and swelling pressures, separates the test area from the open tunnel system, and a second plug separates the two sections. This layout provides two more or less independent test sections. The monitoring system is comprised of a dense network of sensors for temperature, total pressure, pore-water pressure, relative humidity and resistivity, as well as some rock mechanical measurements. The heaters of the inner section were turned on in 2001, those in the outer section in 2004. This was followed by several years of monitoring, offering a very valuable data set of early-stage, full-scale repository evolution.

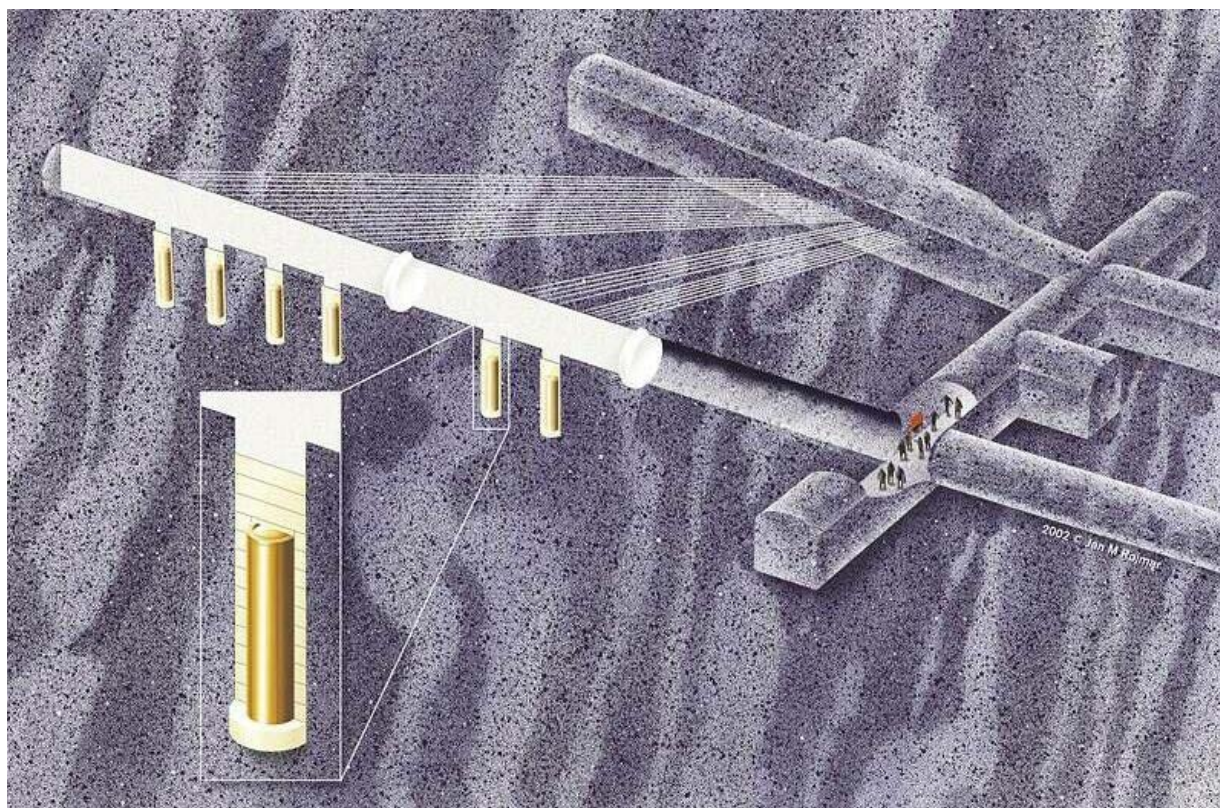

Figure 3.4-9 Schematic layout of Prototype Repository at Äspö HRL (SKB 2011a, b).

In 2011, SKB excavated the outer section of the Prototype Repository while extensive samplings were performed. Approximately 1,000 samples of the backfill and about 3,000 samples of the buffer were taken to determine water content and density. The two canisters were lifted up and transported to SKB's

Canister Laboratory in Oskarshamn for additional investigations. The main objectives of dismantling the outer section were to (1) investigate the density and water saturation of the buffer and backfill, (2) investigate the interface between buffer – backfill and between backfill – rock surfaces, after seven years of wetting, (3) measure and examine the canisters (positions, mechanical stress, corrosion), (4) investigate the bedrock after dismantling, (5) study biological and chemical activities in the buffer and backfill, and (6) study possible changes of the buffer material caused by temperature and saturation processes. The observations made in one of the excavated deposition holes (Figure 3.4-10) are the focus of the prototype Repository modeling task of the EBS Task Force, the objective being to verify the THM processes occurring during heating and resaturation, and validation against the post-mortem analysis. The task involves modeling of one of the two outer deposition holes. UFD researchers are not currently participating in this task.

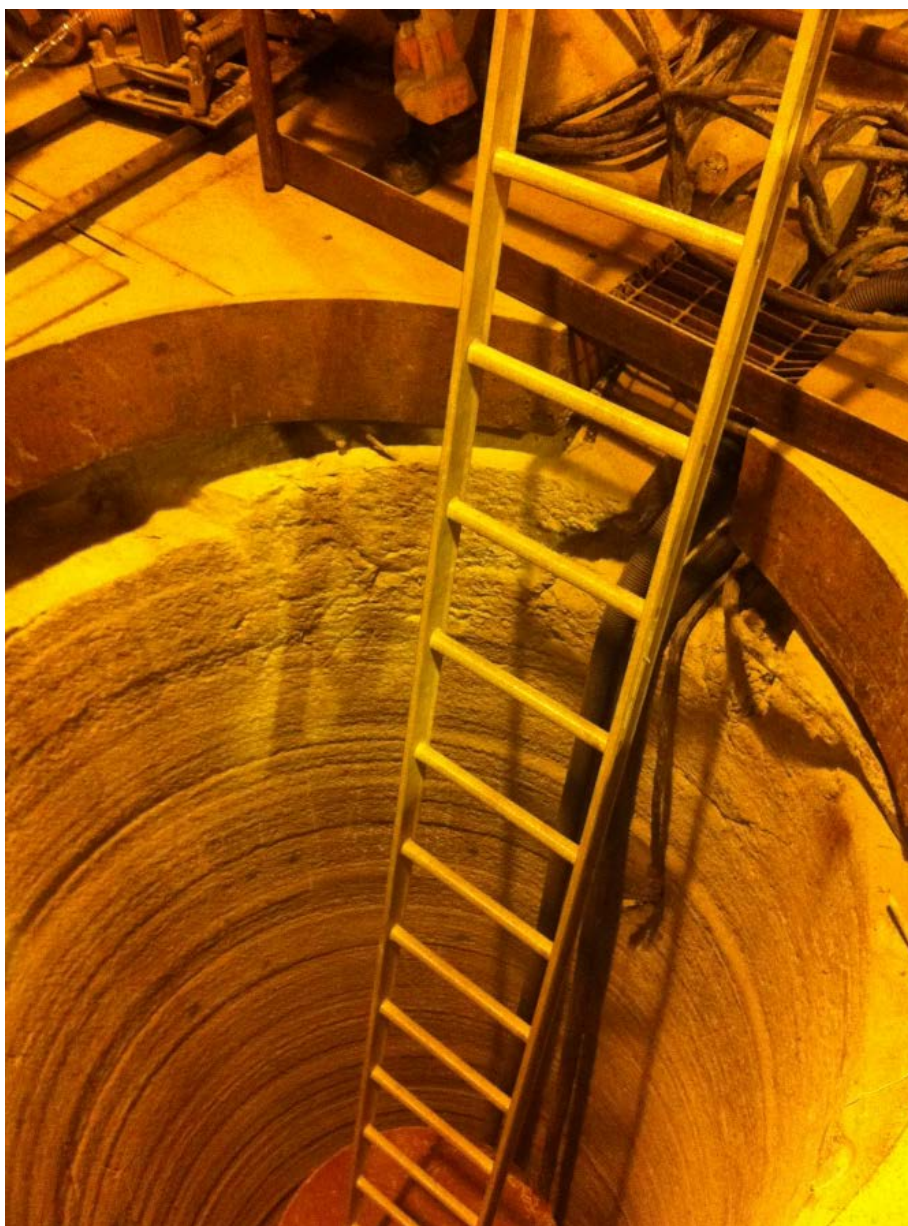

Figure 3.4-10 Prototype Repository at Äspö HRL: Photo of excavated deposition hole.

3.4.3.3 Potential Future EBS-THM Tasks and Outlook

The EBS-THM Task Force is considering initiation of new tasks and has been soliciting input from its task force participants. Several ideas have been brought up in recent meetings in Berkeley (December 2014), Barcelona (May 2015) and Prague (May 2016), some of which may be of relevance to DOE/UFD campaign:

- Task on homogenization in unsaturated barriers (as a continuation of the Homogenization task described in Section 3.4.3.1)
- Task on modeling of water transport in pellet filled laboratory chambers, which would aim to develop new material models for the time-dependent water uptake simulations of pelletized buffer materials
- Task on modeling the FEBEX-DP Experiment (see details in Section 3.3.2)
- Task on gas transport in bentonite utilizing new gas injection laboratory experiments conducted by the University of Bern

The above R&D activities have common goals for potential collaboration with the DOE UFD. Some modeling groups have expressed their potential interest on the gas transport task and the FEBEX-DP Experiment when data become available. DOE/UFD will be represented at future task force meetings and will help finalize the future task list of the EBS-THM Task Force.

3.4.4 EBS-C Task Force

The EBS-C section of the EBS Task Force, led by Urs Maeder from the University of Bern, aims at advancing the fundamental understanding of physicochemical processes in clay or bentonite materials relevant to various aspects of safety assessment. While ultimately a tight integration between EBS-THM and EBS-C is desired, the two EBS sections are currently working on different modeling tasks, and EBS Task Force meetings are jointly held but in separate sessions for THM and C. In addition, in contrast to the EBS-THM section, which usually has a tight connection between models and experiments, the “chemical” task force has been mainly working on conceptual model development and modeling benchmark studies of varying complexity. The main goals of the EBS-C section are:

- To develop and test alternate porosity concepts that explain fundamental properties like ion and water transport and swelling pressure in bentonite buffers and other nanoporous materials,
- To assemble experimental data sets (literature and/or own experiments) that allow testing of alternate concepts and assess so their relative merits
- To gain insight at the molecular scale of physicochemical processes within smectite interlayers (e.g., via MD simulations)
- To further develop numerical tools that allow for a general implementation of these chemical aspects into a THM framework (integration with EBS-THM). There is presently no THM code available that integrates a full chemical module including an electrostatic treatment of pore water, and likewise there is no general reactive transport code that handles an electrostatic treatment of pore water and linked to HM processes.

3.4.4.1 Modeling Benchmarks

In terms of model comparison, the EBS-C group has been working on benchmark data sets of various complexity based on experiments. While these existing benchmarks are generally highly idealized and

quite simple in terms of geometry, they deal with questions of chemical transport of high complexity. The following provides a brief description of the benchmark data sets used in the EBS-C Task Force.

Benchmark 1: Salt Diffusion in Montmorillonite

This benchmark experiment evaluates diffusion of salts (Na/Ca) through montmorillonite clay. To effectively prevent ion exchange, the cation type of the source saline solution is equal to the charge-compensating cation in the montmorillonite structure. Figure 3.4-11 shows the experimental setup used in this experiment (Birgersson 2011). The experimental device is fitted with a pressure transducer to measure swelling pressure. Various source solution compositions were considered:

- 1 M, 0.4 M, and 0.1 M NaCl in the Na-montmorillonite case.
- 0.4 M, 0.1 M, and 0.25 M CaCl₂ in the Ca-montmorillonite case.

The target solution was maintained diluted during the experiment. Electrochemical measurements were used to measure electrolyte concentrations in the target solution. The key measurements in this experiment are the swelling pressure (axial stress) and salt concentration in the target solution. In addition, measurements of water/solid mass ratio were performed upon tests by weight difference between dry and wet samples. Experimental data for this experimental are available through the SKB EBS TF website. The experiments are discussed in Birgersson et al. (2009).

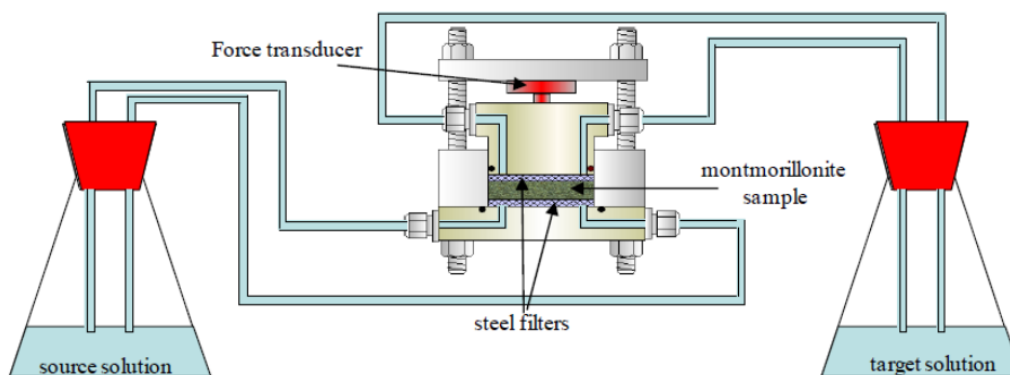

Figure 3.4-11 Experimental setup for Benchmark 1 involving salt diffusion experiment in montmorillonite (Birgersson 2011; Birgersson et al. 2009).

Benchmark 2: Gypsum Dissolution in Na- and Ca-Montmorillonite

This benchmark experiment is similar to Benchmark 1 since the experimental setup is the same but the clay sample is different. This experiment evaluates through-diffusion and gypsum dissolution in a mixed sample of montmorillonite clay and gypsum in a configuration depicted in Figure 3.4-12. Gypsum powder is sandwiched between water-saturated montmorillonite clay samples. Water saturation was attained by monitoring the stabilization of swelling pressure in the cell. Experiments and data collection were conducted in the same fashion as in Benchmark 1. Through-diffusion and gypsum dissolution experiments were performed by controlled solution concentrations in the source and target solution reservoirs. This allows for control of chemical gradients induced by solution concentration in the reservoirs. The experiments were conducted in configurations of Na-montmorillonite – Gypsum – Na-montmorillonite and Ca-montmorillonite – Gypsum – Ca-montmorillonite. These experiments are important in evaluating the potential effects of secondary minerals in bentonite. Such effects have been

identified in bentonite hydrothermal experiments conducted by UFD (Cheshire et al. 2014), where degradation of secondary phases could yield marked effects on the altered mineral assemblage and solution chemistry.

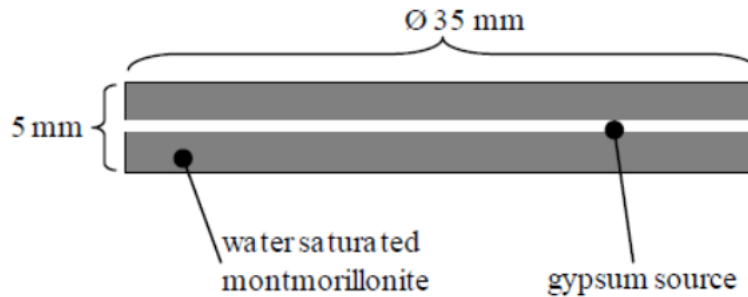

Figure 3.4-12 Sample configurations for Benchmark 2 experiments (Birgersson 2011).

Benchmark 3: Ca/Na Ion Exchange in Montmorillonite

This benchmark consists of ion exchange experiments on compacted Na-Ca montmorillonite having different densities and test solutions (Birgersson 2011). The purpose of these tests is to evaluate ion exchange equilibria along with diffusion of Na and Ca in saturated montmorillonite clay. It also investigates the effects of solution chemistry on swelling pressure. The experimental cell shown in Figure 3.4-13 is similar to Benchmarks 1 and 2 except that input solutions are recirculated through the semi-permeable membrane filters (Birgersson 2011). Swelling pressure was monitored constantly to confirm the attainment of an equilibrium state. Chemical analyses of different equilibrium states were used in the evaluation of cation exchange capacity.

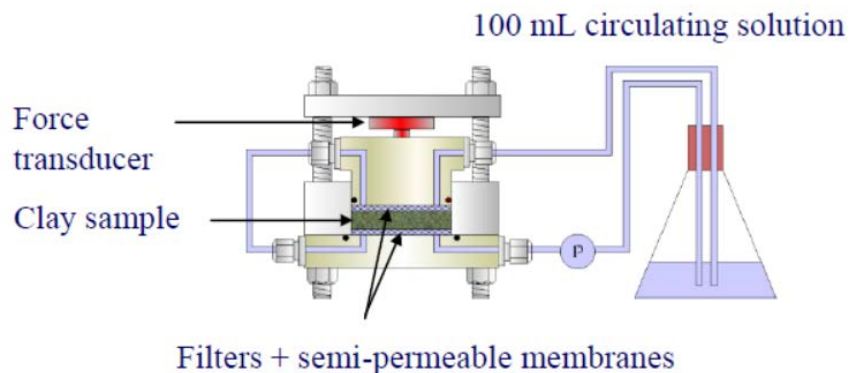

Figure 3.4-13 Experimental setup for Benchmark 3 to investigate ion exchange and effect on swelling pressure (Birgersson 2011; Birgersson et al. 2009).

Benchmark 4: Multi-Component Advective-Diffusive Transport Experiment in MX-80 Bentonite

Benchmark 4 investigates a percolation experiment (Figure 3.4-14) where an input solution of synthetic groundwater is injected through a sample of bentonite MX-80 (Birgersson 2011). The pressure difference (i.e., hydraulic gradient) in the sample is maintained constant throughout the experiment while keeping

constant flow. This allows for periodic sampling of outlet solutions with time. The setup also allows for monitoring of hydraulic and electrical conductivity. Experimental data consisting of solution concentrations of synthetic groundwater constituents (Na^+ , K^+ , Mg^{++} , Ca^{++} , Sr^{++} , Cl^- , Br^- , SO_4^{--} , NO_3^- , and deuterium) are available the SKB EBS TF website. Alt-Epping et al. (2015) provided reactive transport simulations for four computer codes using this benchmark. These authors also examine the effects of electrostatic effects on diffusion using the appropriate implementation in the simulation code. Such benchmarking exercise is not only important for code inter-comparisons but also to evaluate the significance of capturing pore-scale versus continuum effects (upscaling). This allows for analyzing the adequacy or predictive capability of reactive-transport model implementations and their use in the PA of a repository.

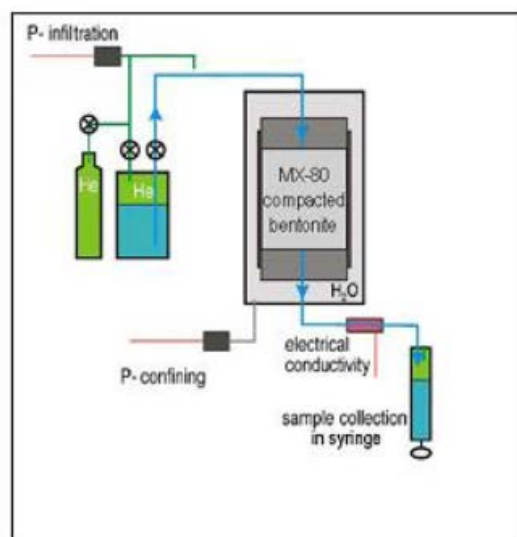

Figure 3.3-14 Schematic diagram of percolation experiment setup for compacted bentonite (Birgersson 2011).

Benchmark 5: Diffusion of Selected Anions through Compacted Bentonite

This benchmark describes the diffusion of the anions Cl^- , I^- , and SeO_4^{--} in compacted Czech bentonite (Birgersson 2011; Hofmanová and Červinka 2014). Radionuclides of these anionic species ($^{36}\text{Cl}^-$, $^{129}\text{I}^-$, and $^{79}\text{SeO}_4^{--}$) were used in the diffusion experiments. The aim of this study is to evaluate anionic retardation due to electrostatic effects in saturated bentonite at constant ionic strength of 0.1 M. The experimental setup is made up of a diffusion cell (Figure 3.4-15) containing compacted bentonite between two solution reservoirs (source and target). The bentonite sample is lined at each fluid contacting face with stainless steel filters. Samples were saturated under vacuum conditions.

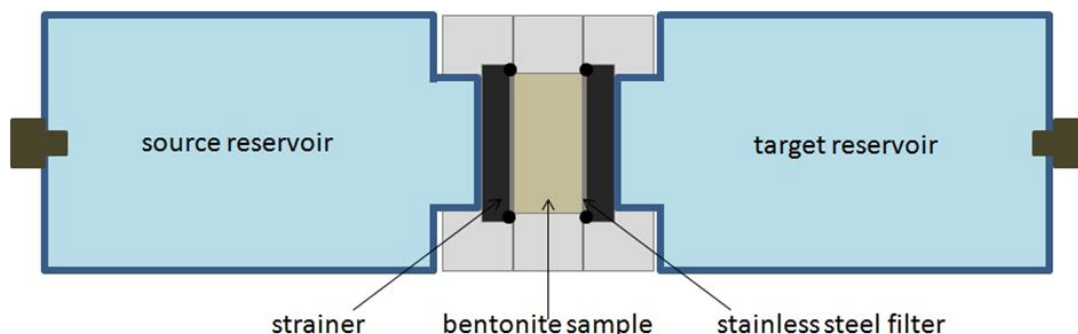

Figure 3.4-15 Schematic diagram showing diffusion cell used in Benchmark 5 (Birgersson 2011; Hofmanová and Červinka 2014).

3.4.4.2 Potential Future EBS-C Tasks and Outlook

The ongoing Benchmarks (1–5) provide a platform for collaboration tasks that are aligned with UFD experimental and modeling activities, for example:

- Molecular dynamics (MD) and first principles modeling of clay interlayer chemistry: MD modeling has been identified as a potential future activity in the EBS-C Task Force. This work could target sorption dynamics at clay edge sites and diffusion effects using the expertise from the UFD R&D on MD modeling on clay.
- Diffusion in compacted clay (model/experiment): Experimental and modeling activities on diffusion through clay conducted at LBNL and LLNL can benefit from similar work in the EBS-C Task Force (Benchmarks 1 – 5). This collaboration should be centered on the leveraging of existing data to examine the effects of electrostatics on reactive diffusion in porous clay.
- The effect of soluble or unstable phases in the buffer/backfill clay matrix: Current UFD experimental activities on clay interactions have revealed the effects of minor phases on the high temperature degradation of barrier clay material (Cheshire et al. 2014). Benchmark 2 has provided a data set on the effect of gypsum dissolution embedded with clay.

In addition, the EBS-C Task Force is presently considering new ideas about future activities and priorities. Below is a list of some of the topics discussed in recent EBS workshops.

- Experiments discriminating among concepts: Recent work has described “up-hill diffusion” of Na across a clay membrane and against a distinct salinity gradient between external reservoirs. Clearly, such behavior cannot be modeled without electrostatic effects that dictate ion equilibrium within the clay. A more difficult issue is to distinguish among the relative merits of the homogeneous mixture model and dual porosity models that treat electrostatic effects in the porosity representing the interlayer volume. There is largely agreement within the Task Force that a proper treatment of ion equilibrium within the interlayer volume (via Donnan approximation to the Poisson-Boltzmann distribution, for example) should be a central element in a conceptual model and its implementation.
- Interlayer chemistry: Accepting that chemistry in swelling clays largely happens within the interlayer space leads to some currently unresolved issues. For example, what type of water is contacting a canister in contact with bentonite? Is it the “free pore water” that exists in dual-porosity models, or is it interlayer water containing much higher concentrations of cations, including protons?

- HM-C coupling: There are relatively few experiments that include a complete description of the pore water chemical aspects and hydromechanical constraints. It is thought that such experiments are needed as test cases for implementing a coupling between chemistry and hydromechanics. Benchmarks 1-4 are also characterized with respect to swelling pressure or total pressure constraints, and could be used in this context. A new initiative by POSIVA (with Uni Bern) aims at providing a comprehensive HMC data set based on new squeezing experiments under drained conditions, as basis for future modeling.
- Reactive transport modeling at backfill/host-rock contact: This is an additional proposal that appears to be not based on an experiment. It aims to represent interactions between backfill, EDZ, and a fracture in host-rock. The relevance is in assessing different approaches of modeling surface reactions (ion exchange, surface complexation, Electrical Double Layer (EDL)) and quantifying S fluxes that may induce corrosion of the canister (Source: Martin Birgersson and Urs Mader, SKB EBS-C Task Force presentation at Prague meeting).

Similar to the EBS-THM task force, there is some interests in particular activities but the suggested “official tasks” to be carried forward in the SKB EBS-C task force are uphill diffusion, mini-ABM diffusion test, Ca/Na ion exchange in montmorillonite (pH13), HM-C squeezing tests, and the multi-component transport PV control experiments (A. Gens, Meeting Notes 2016). The mini-ABM test investigates the differences between diffusion in interlayer pores and bulk pore water. DOE/UFD will be represented at future task force meetings and will help finalize the future task list of the EBS-C Task Force.

3.4.5 SKB Task Force Summary

Benefits of Participation:

- Access to **several** sets of experimental data from **one** URL in crystalline rock
- Opportunity to perform **modeling and analysis of existing data** in collaboration with other modeling groups (typically less direct interaction with the project teams that run or interpret the experiments)

Status of Participation:

DOE joined both task forces in January 2014. Under the umbrella of the GWFTS task force, UFD researchers have participated in FY14 and FY15 in the interpretation and modeling of the BRIE bentonite-rock interaction experiment (Section 3.4.2.1), and in FY16 have focused on the new task involving diffusion and sorption experiments (Task 9, see Sections 3.4.2.2 and 6.2.2).

Outlook:

UFD’s collaboration in the GWFTS Task Force will continue to focus on the new Task 9 (LTD-SE and REPRO experiments). In regards to the EBS Task Force, the task portfolio is still somewhat in development but various intriguing and relevant task proposals have emerged. DOE/UFD will be represented at future task force meetings and will help finalize the future task list of the EBS-THM and EBS-THC Task Forces.

Contact Information:

DOE Contact:
Prasad Nair, DOE-NE

UFD Contact:

Jens Birkholzer, LBNL

Hari Viswanathan, LANL (GWFTS Task Force)

Carlos Jove-Colon, SNL, and Liange Zheng, LBNL (EBS Task Force)

SKB Contact:

Anders Sjöland, Executive Secretary, Technical-Scientific Council, SKB, Sweden

Björn Gylling, Secretary of GWFTS Task Force, SKB, Sweden

Antonio Gens, EBS Task Force for THM, from UPC, Spain

Urs Maeder, EBS Task Force for THC, University of Bern, Switzerland

3.5 NEA's Cooperative Initiatives

The previous sections describe initiatives that foster active research with other international disposal programs, provide access to field data, and/or may allow participation in field experiments in URLs (Sections 3.1 to 3.4). Here we briefly touch on NEA's international collaboration initiatives where the focus is less on active collaboration than on the exchange of information and shared approaches.

3.5.1 NEA's Clay Club

In 1991, the Nuclear Energy Agency (NEA) established a "Working Group on the Characterization, the Understanding and the Performance of Argillaceous Rocks as Repository Host Formations," known more commonly as the "Clay Club" (<http://www.oecd-nea.org/rwm/clayclub/>). Since 2000, the Clay Club has operated under the umbrella of NEA's Integration Group for the Safety Case (IGSC), an international forum on confidence building in repository technical safety cases and on the underlying methodological and scientific bases for the purpose of decision-making in repository development. The Clay Club promotes the exchange of information and shared approaches and methods to develop and document an understanding of clay media as a host rock for a repository. The Clay Club generally establishes the program of work at its own initiative, based on experience and progress in repository programs of its member countries. The work program and products are presented at each IGSC plenary meeting. The Clay Club may also carry out specific tasks at the request of IGSC dealing with, for instance, the analysis of performance of clays for safety assessment purposes. The Clay Club chooses among a variety of mechanisms for its work program, including, for example: to install task-oriented expert groups; to organize workshops; to hire dedicated consultants and specialists; to collaborate in conferences; or a combination of these. A high priority is placed on making the results of Clay Club projects publicly available, using printed and/or electronic publications. The Clay Club working group is composed of senior technical experts with experience in assembling or reviewing the understanding of argillaceous media as host rocks for deep geologic disposal projects. Members represent waste-management agencies, regulatory authorities, academic institutions, and research and development institutions.

The work program and modus operandi of the Clay Club emphasize the pooling of resources, the sharing and synthesis of understanding and experiences, and the communication of findings to various audiences. Clay Club projects are established most often at the initiative of the members; work may also be undertaken on specific topics at the request of the IGSC. The topics of work reflect issues of common interest, considering the experience, progress and challenges of national program. Decisions on projects are made on a consensus basis, taking into account the importance and urgency of the issue, the breadth of interest (i.e., the number of national program for whom the issue is considered a key issue), and the necessary resources and schedules to accomplish the work proposed. Communication within the group takes place through plenary meetings, which occur on at least an annual basis.

In general, the Clay Club addresses recommendations, trends, and information gaps concerning the characterization, evolution, modeling, and performance of argillaceous media, for example regarding:

- Understanding (and development of associated conceptual models) of argillaceous rocks through site characterization and expert evaluation, including both field and laboratory work on key issues
- Quality (characterization, understanding and conceptualization capability) and limitations of the information that is available
- Performance assessment and supporting models, including model abstraction and simplification as well as the traceability of related data and information
- Links and potential knowledge transfer between the understanding of clay as a host material and its use in engineered barrier systems of geologic repositories
- Relevant progress in R&D on clay materials in other fields or industries, such as petroleum exploration and CO₂ sequestration

Examples of topics that have been (or are being) addressed are:

- Catalogue of characteristics of the various argillaceous media;
- Relevant FEPs
- Use of natural tracers to support long-term dominance of diffusion;
- Role and influence of faults and fractures at repository depths
- The quality and limitations of the information that is available
- Potential for self-sealing of fractures in clay rocks
- Imaging and observations of clays at the microscopic level
- Anomalous heads in clay media
- Micro-mechanical models

Membership in the Clay Club requires no formal agreement, but rather a simple expression of interest, acceptance by current Clay Club members, and a voluntary annual financial contribution. Each member organization sends a representative to the annual meetings and provides a report on ongoing activities. Clay Club members are expected to: (1) promote Clay Club activities in their own organization; (2) provide relevant data and bibliographic material to support Clay Club initiatives; and, (3) as appropriate and on an ad hoc basis, make human or financial resources available to the Clay Club initiatives. In contrast to other international initiatives (such as the Mont Terri Project, DECOVALEX, or SKB's Task Forces), the Clay Club is not about active R&D collaboration, but rather about having a regular forum for in-depth discussion and information exchange. Current members are institutions from Belgium, Canada, France, Germany, Hungary, Japan, Netherlands, Spain, Switzerland, and United Kingdom.

3.5.2 NEA's Salt Club

The Salt Club brings together nations currently considering rock salt as a candidate medium for deep geologic disposal of High-Level Waste (HLW) and long-lived radioactive waste (<http://www.oecd-nea.org/rwm/saltclub/>). The club's mission is to develop and exchange scientific information on rock salt as a host rock formation for deep geologic repositories. By promoting information and knowledge exchange, the Salt Club also intends to stimulate interest in other nations with appreciable rock salt deposits to consider rock salt as a viable repository medium. In addition to the technical aspects, the working group also aims at transferring obtained knowledge to programs at different phases of development, fostering education and training of future subject-matter experts in the field of rock salt, and cooperating with other NEA working groups (e.g., the Forum on Stakeholder Confidence, FSC) to engender public acceptance and building stakeholder confidence. The Salt Club working group is composed of senior technical experts with experience in assembling or reviewing the understanding of salt formations as host rock for deep geologic disposal projects. Members represent waste management

agencies, regulatory authorities, academic institutions, and research and development institutions. Salt Club members have a level of seniority in their organizations such that they are able to mobilize resources to contribute to Salt Club initiatives. DOE is a current member of the Salt Club; other members are Sandia National Laboratories (SNL), Los Alamos National Laboratory (LANL), and institutions from Germany, the Netherlands, and Poland.

The club started in 2011 as a NEA working group, comprised of scientists and experts in developing disposal in geologic rock salt formations. The official kick-off meeting for the Salt Club took place on April 20, 2012, at the OECD NEA headquarters in Paris to discuss initial work activities, schedules and other project details. The 5th Nuclear Energy Agency (NEA) Salt Club Meeting was held September 6, 2016 in Washington D.C., in conjunction with the 7th US/German Workshop on Salt Repository Research, Design and Operation on September 7-9, 2016. The Salt Club has the following areas of interest:

- Geomechanical issues (coupled processes, excavation damaged zone (EDZ) behavior, rock mechanic issues, backfilling, sealing and plugging of rooms, drifts, shafts)
- Brine and gas migration
- Actinide and brine chemistry
- Microbial activities in rock salt
- Geochemical issues (radionuclide chemistry, modeling, natural analogs)
- Technical/technological and engineering issues (construction, operation, closure)
- Performance of geotechnical barriers
- Contributions to the Safety Case (e.g., FEP catalog, scenarios, performance assessment issues, uncertainties, use of natural analogs).

Similar to the Clay Club, the Salt Club is not about active R&D collaboration, but rather about providing a regular forum for in-depth discussion and information exchange.

3.5.3 NEA's Thermochemical Database Project

The purpose of the international Thermochemical Database Project (TDB) is to make available a comprehensive, internally consistent, quality-assured and internationally recognized chemical thermodynamic database of selected chemical elements, in order to meet the specialized modeling requirements for safety assessments of radioactive waste disposal systems. The unique feature of the TDB project is that the data are evaluated and selected by teams of leading experts drawn from universities and research institutes around the world, through a critical review of the existing primary experimental sources. Detailed TDB reports document the process leading to the selected values. Participating countries are as follows: Belgium, Canada, Czech Republic, Finland, France, Germany, Japan, Spain, Sweden, Switzerland, United Kingdom, and the United States. A history of NEA TDB activities was recently published and summarizes the accomplishment of the project since its inception in 1984 (Ragoussi and Brassinnes 2015).

The project has operated in five phases over almost two decades. During the first part of the project, a high priority was assigned to the critical evaluation of the data of inorganic compounds and complexes of the actinides uranium, americium, neptunium, and plutonium, as well as the inorganic compounds and complexes of technetium. The second phase provided for further needs of the radioactive-waste-management programs by updating the existing database and applying the TDB methodology to new elements present in radioactive waste (as fission or activation products): nickel, selenium and zirconium, and simple organic complexes. The third phase started in 2003, with three new reviews on thorium, tin, and iron (part 1), and with the constitution of an expert team for the preparation of guidelines for the evaluation of thermodynamic data for solid solutions. The fourth phase (2008-2013), included three

reviews concerning molybdenum, iron (part 2) and ancillary data, and the initiation of two state-of-the-art reports on cement minerals and high-ionic-strength solutions. The program for the current fifth phase (2014-2018) of the Thermochemical Database (TDB) Project comprises the following activities:

- Completion of the reviews from the fourth phase
- Preparation of an update of the phase II actinide volumes, including technetium
- Preparation of a state-of-the-art report on the thermodynamic properties of cement minerals
- Preparation of a state-of-the-art report on thermodynamic considerations for actinides in high-ionic-strength solutions

DOE has been participating in the TDB Project for a while, and is currently represented by scientists from LLNL. FY16 activities conducted by UFD scientists in support of the TDB project are described in Section 7.2.

3.5.4 NEA's Repository Metadata (RepMET) Project

The Repository Metadata (RepMET) Project involves over ten countries and the objective is to create a metadata registry that can be used by national programs to manage their repository data and records in a way that is harmonized internationally and is suitable for long-term management (McMahon 2016). The benefit of the project is to eventually supply those countries without advance waste management programs the metadata registry as a starting point. Beneficiaries will not likely be countries like with advanced programs such as the U.S., United Kingdom, Sweden, Finland or France, but all of these countries are participating and contributing their experience and expertise. SNL researchers have been participating in this NEA sponsored project for the last few years, and have created conceptual data models for waste-package, HLW/SNF (Spent Nuclear Fuel) repository (currently in development) and geoscience (currently in development). Kevin McMahon from SNL was recently elected Vice Chair of the project (the chair is from the NDA in the UK).

This page is intentionally blank.

4. BILATERAL COLLABORATION OPPORTUNITIES

Access to data from international field experiments and participation of UFD researchers in collaborative field studies can also be facilitated via direct informal or semi-formal agreements between national laboratories and international partners. Several UFD scientists have close relationships with their international counterparts, resulting from workshops and symposia meetings, or from collaboration outside of UFD's scope. International disposal programs benefited from collaboration with UFD scientists and are generally quite open to including them in their ongoing research teams. This may require preparation of Memorandum of Understandings (MoU) or other types of bilateral agreements. The U.S. DOE has several such bilateral agreements in place, among those the Joint Fuel Cycle Studies (JFCS) agreement with the Republic of Korea, with the German Federal Ministry of Education and Research (BMWi), with Japan under the JNEAP (Joint U.S.–Japan Nuclear Energy Action Plan) agreement, and with France as a result of a MoU with ANDRA. The subsections below give a short description of selected bilateral collaboration opportunities providing access to valuable data and major field experiments. The first two opportunities with the Republic of Korea and Germany have already resulted in close collaborative research work between UFD scientists and their international counterparts; the others describe opportunities for future collaboration. This list will be amended and updated as new opportunities arise.

4.1 Experiments at KURT URL, Republic of Korea

KURT is a generic underground research laboratory hosted by a shallow tunnel in a granite host rock, located in a mountainous area near Daejeon, Republic of Korea. KURT stands for KAERI Underground Research Tunnel, with KAERI being the Korea Atomic Energy Research Institute. Using KURT, KAERI intends to obtain information on the geologic environment and the behavior and performance of engineered barriers under repository conditions. KURT has a total length of 255 m with a 180 m long access tunnel and two research modules with a total length of 75 m. The maximum depth of the tunnel is 90 m from the peak of a mountain. The horseshoe shape tunnel is 6 m wide and 6 m high (Figure 4.1-1). The tunnel construction at KURT started in March 2005 and was completed in November 2006. An expansion of the tunnel has recently been completed as shown in Figure 4.1-2, which allows for additional several hundred meters of tunnel length for further site characterization and *in situ* testing. The host rock is granite, which is one of the potential host rock types for an HLW disposal repository in Korea. The utilization of radioactive material in KURT is not allowed.

Compared to other URLs, including those discussed in Section 3, KURT is a relatively new facility. The first 5-year research phase started in 2006 after successful completion of the facility. Past or current research works has included (1) geologic characterization and long-term monitoring, (2) development and testing of site investigation techniques, (3) solute and colloid migration experiments, (4) EDZ characterization, (5) borehole heater tests, and (6) investigation of correlation between streaming potential and groundwater flow (Figure 4.1-3). A second 5-year research phase, which started in 2012, comprises additional site characterization work related to the tunnel expansion and *in situ* long-term performance tests on a 1/3 scale engineered barrier system at KURT. The focus of the site characterization work is a major water-conducting feature (MWCF), which was initially identified from surface boreholes and which will soon be accessed from the new expansion tunnels. The hydrogeological, geochemical, and transport properties of the MWCF will be characterized, before, during, and after excavation.

The KURT site offers one unique feature in regards to *in situ* borehole characterization and deep borehole disposal R&D. The site hosts an existing deep (1 km) borehole drilled into granitic bedrock, which provides a unique opportunity for developing and testing techniques for *in situ* borehole characterization

in fractured crystalline rocks. The DB-2 borehole was drilled from the surface to a depth just outside of the KURT facility (Figure 4.1-4) to better understand the deep geologic, hydrogeological, and chemical characteristics around the KURT site, and to specifically explore the MWCF. The deep borehole could offer possibilities of collaboration regarding deep borehole disposal concepts. The Republic of Korea and KAERI are interested in further exploration of deep borehole disposal concepts.

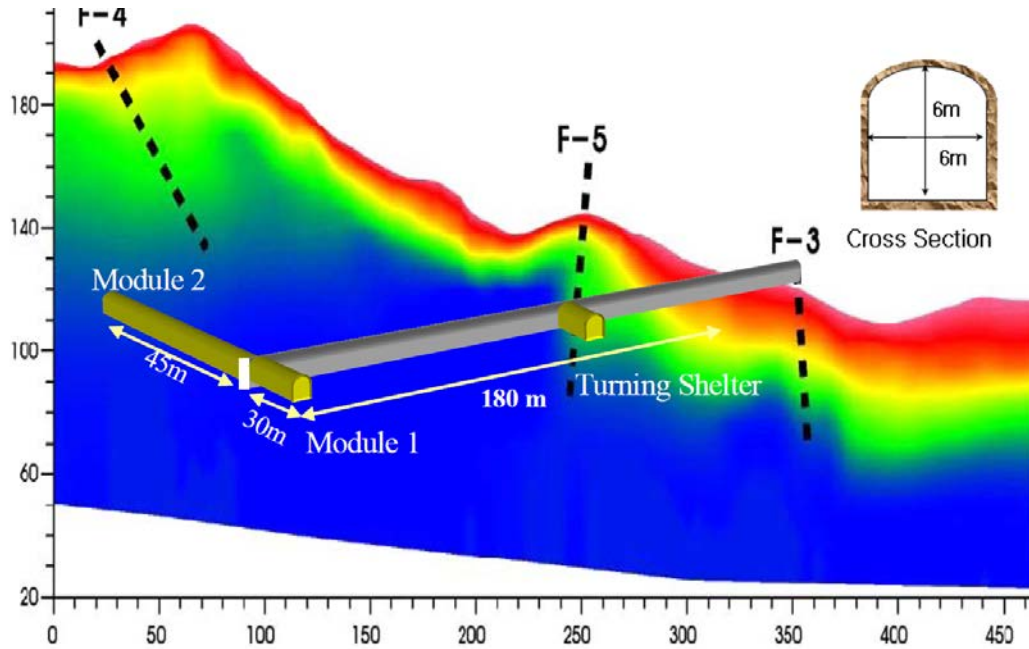

Figure 4.1-1 Layout of the KURT URL in Daejeon, Korea before extension (KAERI 2011).

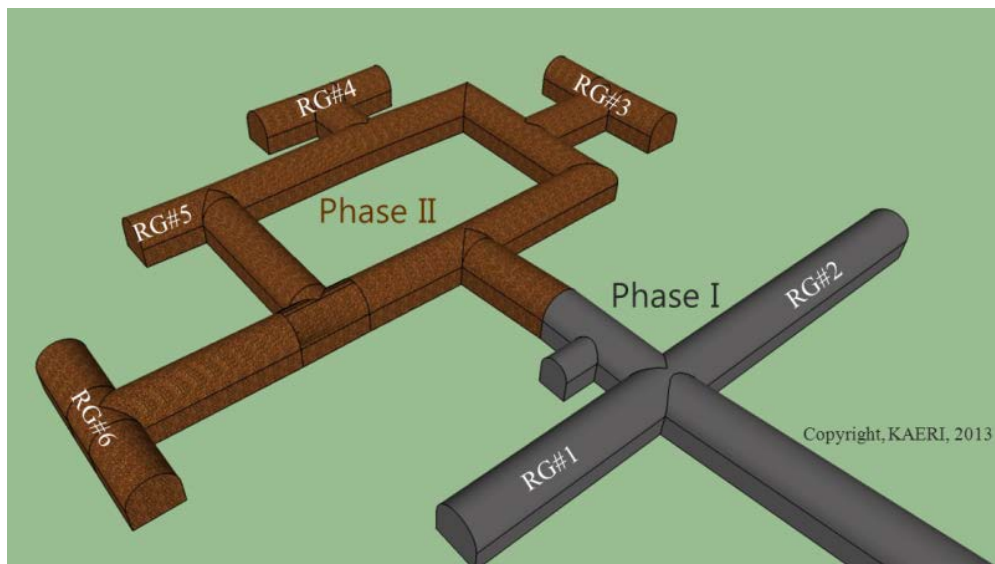

Figure 4.1-2 Layout for tunnel extension of KURT (Wang et al. 2014).

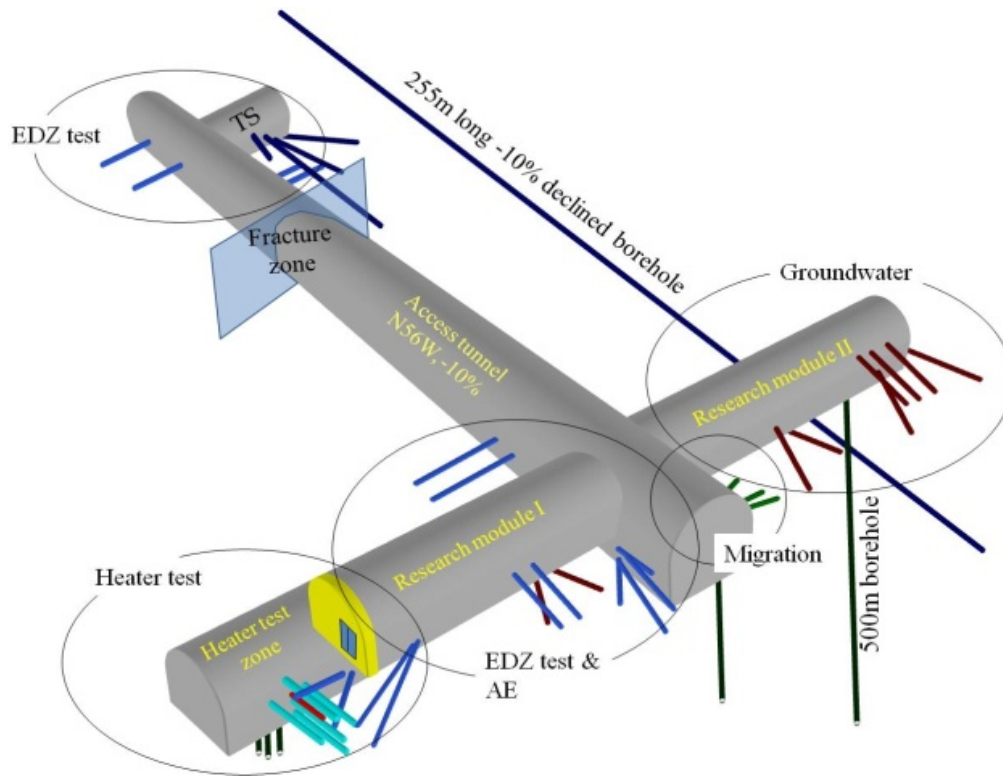

Figure 4.1-3 Location of *in situ* tests and experiments with related boreholes at KURT (from Wang et al. 2014).

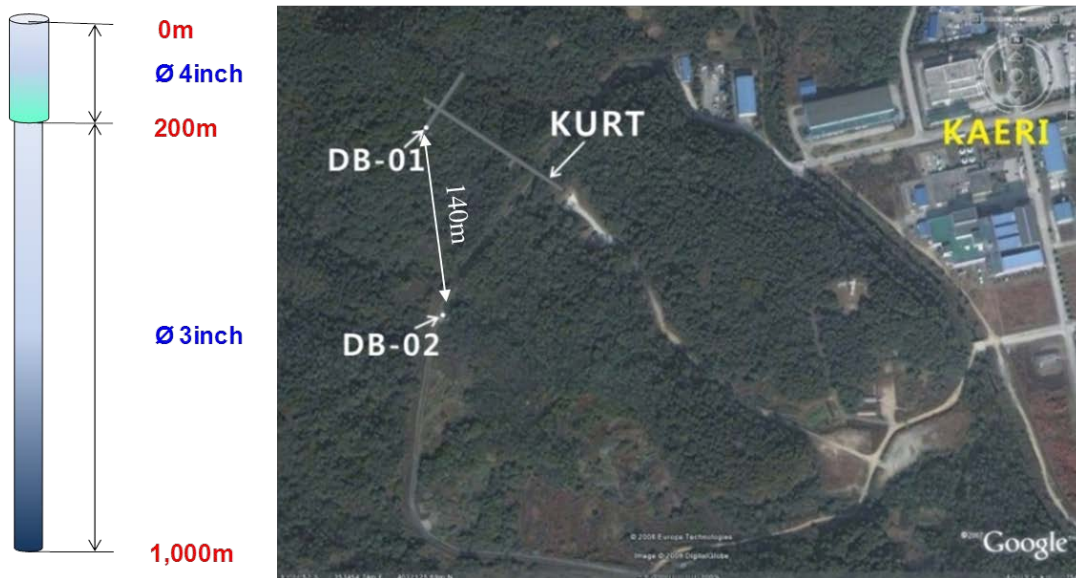

Figure 4.1-4 Specification of DB-2 borehole and its location near KURT site (from Wang et al. 2014).

In general, KAERI is open to international collaboration and is looking for new ideas and experimental designs for future tests. A few years ago, a formal commitment to collaboration on the management of nuclear fuel was established between the United States and the Republic of Korea (ROK). The agreement, called the Joint Fuel Cycle Studies (JFCS), between the U.S. Department of Energy, the ROK Ministry of Education, Science & Technology, and the ROK Ministry of Knowledge Economy, is currently mainly a forum for information exchange on fuel-cycle technologies, but has some active research elements related to geologic disposal. Researchers at SNL and KAERI have developed a multi-year plan for joint field testing and modeling to support the study of high-level nuclear waste disposal in crystalline geologic media, which includes sharing of KURT site characterization data. There are three specific collaborative tasks, as follows: (1) streaming potential (SP) testing regarding correlation with groundwater flow, (2) technical data exchange regarding site characterization and buffer material specifications, and (3) technique development for *in situ* borehole characterization. Tasks 1 and 2 were completed in FY2016, and the results are documented in Wang et al. (2016). The SP tests showed that there were changes in the observed SP after injection of tracer, indicating a possibility of using SP signals for monitoring solute transport. In FY2016, KAERI provided SNL with material specification data on their Ca-bentonite material. These data will be useful for the UFD to define its own specification for Na-bentonite materials. For Task 3, KAERI and SNL have initiated the development of in-situ hydrological and geochemical measurements in boreholes. This task is a joint effort between the UFD deep borehole disposal work package and the crystalline disposal R&D work package. More detail on the collaborative research tasks conducted within the KAERI/SNL collaboration given in Section 6.3.1.

4.2 Salt Research Collaboration with German Researchers

DOE/UFD scientists and their German colleagues in academia and other research laboratories collaborate closely on various R&D issues related to disposal of radionuclide waste in salt. A MoU was signed a few years ago between DOE and the German Federal Ministry of Economics and Technology (BMWi) to cooperate in the field of geologic disposal of radioactive wastes (MoU date: November 2011). Four U.S.–German Salt workshops have been held so far to advance collaboration, starting with a preparatory workshop on May 25–27, 2010, in Jackson Mississippi, followed by Peine, Germany, (November 9–10, 2011), Albuquerque, New Mexico (October 8–11, 2012), Berlin, Germany (September 16–17, 2013) (Hansen et al. 2013), Santa Fe, New Mexico (September 8–10, 2014) (Hansen et al. 2015) and Dresden, Germany (September 7–9, 2015). The most recent workshop was held September 7–9, 2016 in Washington, D.C. The overriding premise for U.S./German collaborations is to advance the scientific basis for salt repositories. Today, scientists from both countries have started cooperative work in several areas, including coupled-salt-mechanics modeling and benchmarking (Section 6.1.5), as well as safety case aspects for heat-generating waste in salt (Section 7.1).

Germany has a long history of salt R&D. The country started in 1979 to conduct exploration work at the Gorleben salt dome to evaluate its suitability for waste disposal (Figure 4.2-1). However, a moratorium on further exploration at the Gorleben site was imposed in 2000, mainly due to political reasons. While the moratorium has now been lifted, R&D activities at Gorleben have not yet resumed, and it is questionable whether and when further underground testing at this URL might be conducted. Another mine, the Asse II Mine, was also used as a research facility in the past, between 1965 and 1995, where some major experiments such as the long-term TSDE (*Thermal Simulation for Drift Emplacement*) experiment were carried out. As shown in Figure 4.2-1, the TSDE experiment comprised of two parallel drifts, each of which housing three electrical heaters to simulate emplacement of heat-producing waste. A significant amount of data was collected over several years in 20 monitoring cross sections: temperature, stress changes, displacement, convergence, and porosity of crushed salt, among others. Data from the TDSE experiment are currently used by UFD scientists to validate the large-scale applicability of coupled THM models (Rutqvist et al. 2016) (Section 6.1.5.2). Note that between 1967 and 1978, low-level and

intermediate-level radioactive wastes were placed in storage in other parts of the Asse II mine. Research was eventually stopped; between 1995 and 2004, all underground tunnels and cavities were filled with salt. Today, the Asse II mine is the subject of major controversy because of security concerns regarding water inflow and salt stability.

To date, the joint projects between Germany and the U.S. on salt R&D have primarily focused on domal salt (e.g., Gorleben) rather than bedded salt (e.g., the Waste Isolation Pilot Plant (WIPP) facility). This has changed recently with the onset of two collaborative projects KOSINA and WEIMOS. The KOSINA project focuses on the analysis of integrity of the geological barrier for generic locations in bedded salt and salt pillows by means of geomechanical model calculations (Section 7.1). Partners in KOSINA include Sandia National Laboratories (as an associate partner) and several German institutions, including BGR – Bundesanstalt für Geowissenschaften und Rohstoffe (Federal Institute for Geosciences and Natural Resources), DBE TEC – Deutsche Gesellschaft zum Bau und Betrieb von Endlagern für Abfallstoffe GmbH (The German Society for the construction and operation of waste repositories), GRS – Gesellschaft für Anlagen- und Reaktorsicherheit GmbH (Society for Plant and Reactor Safety), and IfG – Institut für Gebirgsmechanik GmbH (Institute for Geomechanics).

The name of the second project, WEIMOS, is a German abbreviation for: Weiterentwicklung und Qualifizierung der gebirgsmechanischen Modellierung für die HAW-Endlagerung im Steinsalz (WEIMOS), which translates to: Further Development and Qualification of the Rock Mechanical Modeling for the Final HLW Disposal in Rock Salt (McMahon 2016). WEIMOS is concerned with benchmarking and improvement of constitutive models in geomechanics simulations of field experiments conducted in bedded and domal salt, comprising the WIPP/bedded formation in the US and the Asse/dome formation in Germany. In FY16, researchers from Sandia National Laboratory and various German scientists have focused on constitutive model calibration for rock salt using laboratory experiments conducted for the WIPP Room B and D experiments (Reedlunn 2016). Rooms B and D are two drifts located in the northern experimental area at WIPP (Figure 4.2-3). More detail on this work is given in Section 6.1.5.1.



Figure 4.2-1 View of one of the underground tunnels at Gorleben at the 840 m level (BMW 2008).

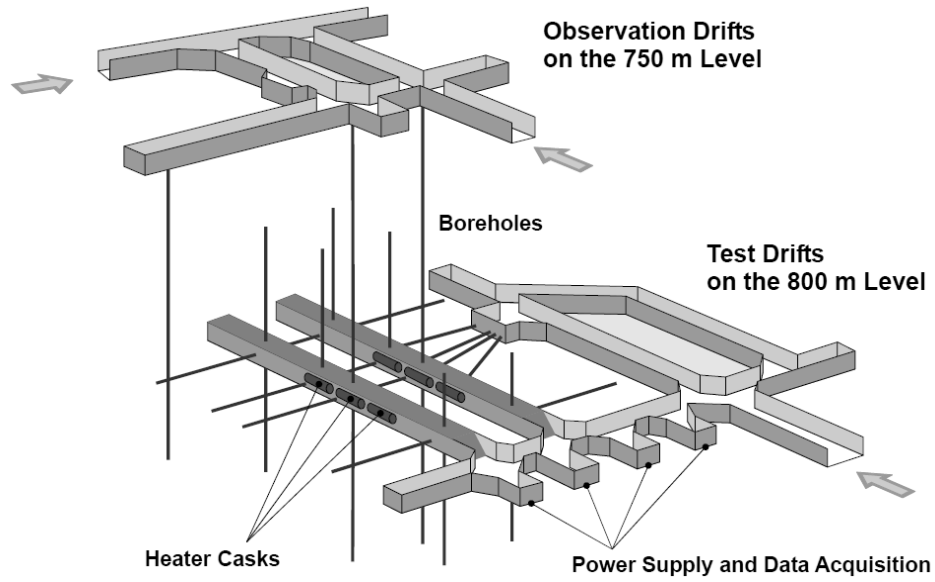

Figure 4.2-2 Schematic view of the two drift tests used in the TSDE experiment (800 m level of the Asse salt mine) (Ruqvist et al. 2015).

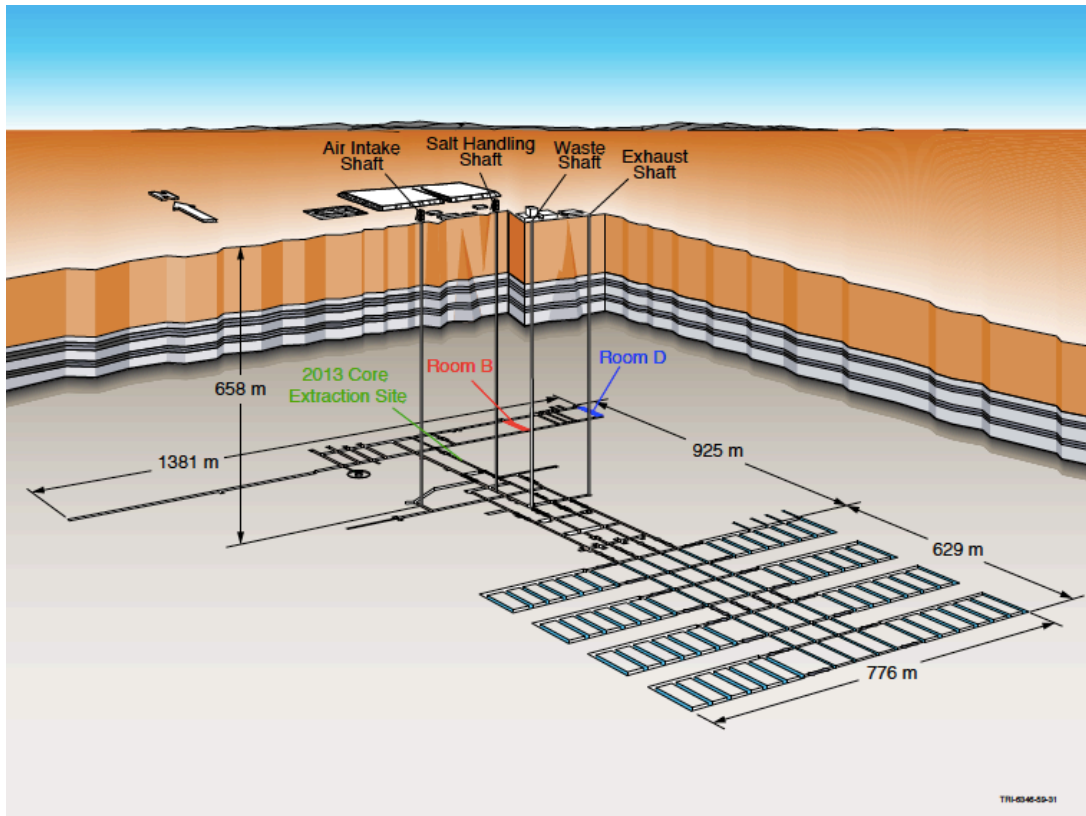

Figure 4.2-3 Locations of Rooms B and D at WIPP (Reedlunn et al. 2016).

4.3 Collaboration Opportunities at ANDRA's LSMHM URL, France

The major underground disposal research facility in France is ANDRA's LSMHM (Laboratoire de recherche Souterrain de Meuse/Haute-Marne) URL sited near Bure in the Meuse and Haute-Marne districts in the east of France, co-located with the proposed French disposal site Cigeo. R&D at Bure aims at studying the feasibility of reversible geologic disposal of high-level and long-lived intermediate-level radioactive waste in the Callovo-Oxfordian clay formation. This facility was licensed in August 1999, and its construction (access shafts, basic drift network with underground ventilation) was finalized in 2006. As shown in Figure 4.3-1, the URL consists of two shafts sunk down to a depth of about 500 m. A network of about 900 m of tunnels and drifts is used for various scientific experiments, engineering technological demonstrations, and the testing of industrial solutions for construction and operation (Figure 4.3-2). DOE and ANDRA have recently signed a Memorandum of Understanding (MoU) for collaborative work in clay/shale disposal at the LSMHM Underground Laboratory near Bure. Furthermore, U.S. and French scientists are starting collaborative work related to clay/shale disposal at the Bure URL under the umbrella of the DECOVALEX-2019 project (see Section 3.2.3.5). ANDRA is organizing a modeling task in this new DECOVALEX phase; the task focuses on upscaling THM modeling from small size experiments (some cubic meters) to real scale emplacement cells (some ten cubic meters) all the way to scale of a waste repository (cubic kilometers). U.S. researchers from LBNL are planning to participate in this task.

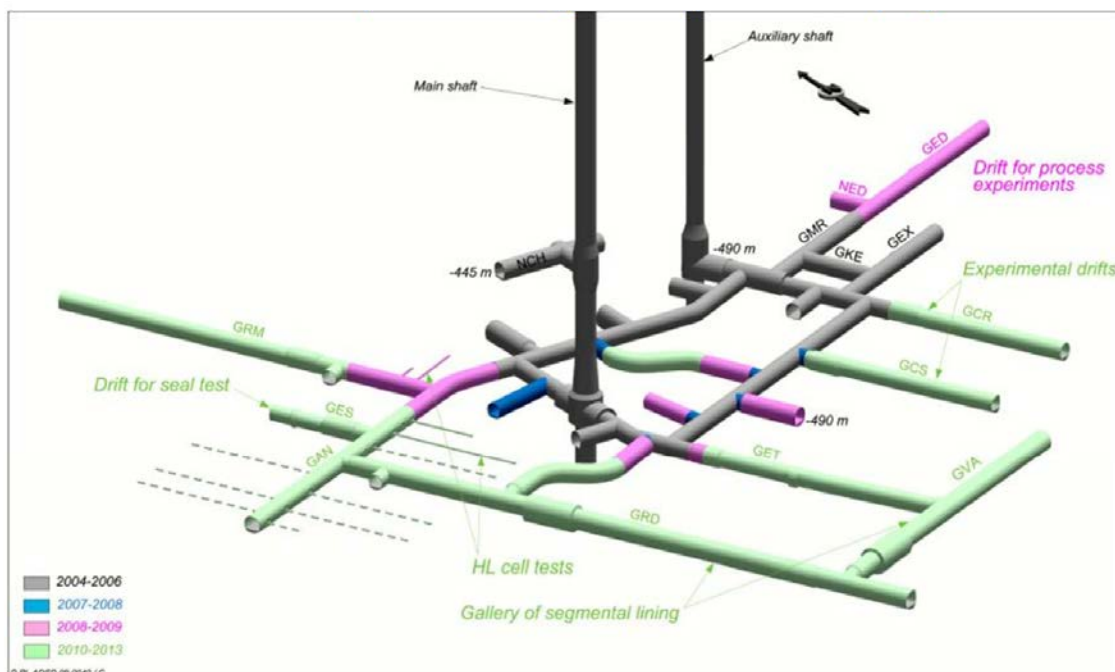

Figure 4.3-1 Layout of the LSMHM URL at Bure, France (Lebon 2011).



Figure 4.3-2 LSMHM URL at Bure, France (from <http://www.andra.fr/download/andra-international-en/document/355VA-B.pdf>).

4.4 Collaboration Opportunities with JAEA's URLs in Japan

Opportunities for active collaborative R&D with Japan exist not only at the Horonobe URL in sedimentary rock (Section 3.2.2.3), but also at this nation's second URL at the Mizunami Underground Research Laboratory, which resides in crystalline rock (Figure 4.4-1). Japan and the United States entertain close collaboration on issues related to nuclear energy under the JNEAP (Joint U.S.–Japan Nuclear Energy Action Plan) agreement. JNEAP has a Waste Management Working Group that meets in regular intervals to discuss joint R&D on, among other topics, waste disposal issues. Japanese research institutions are also a frequent partner in many of the cooperative initiatives that DOE has joined in recent years (Section 3, Table 3.1-1), and both nations have collaborated for several years on the DECOVALEX-2015 task featuring JAEA's Horonobe EBS experiment (see Section 3.2.2.3). JAEA is now organizing a modeling task in the new DECOVALEX-2015 project that utilizes the GREET experiment at Mizunami URL (Section 3.2.3.3). U.S. researchers are planning to participate in this modeling task.

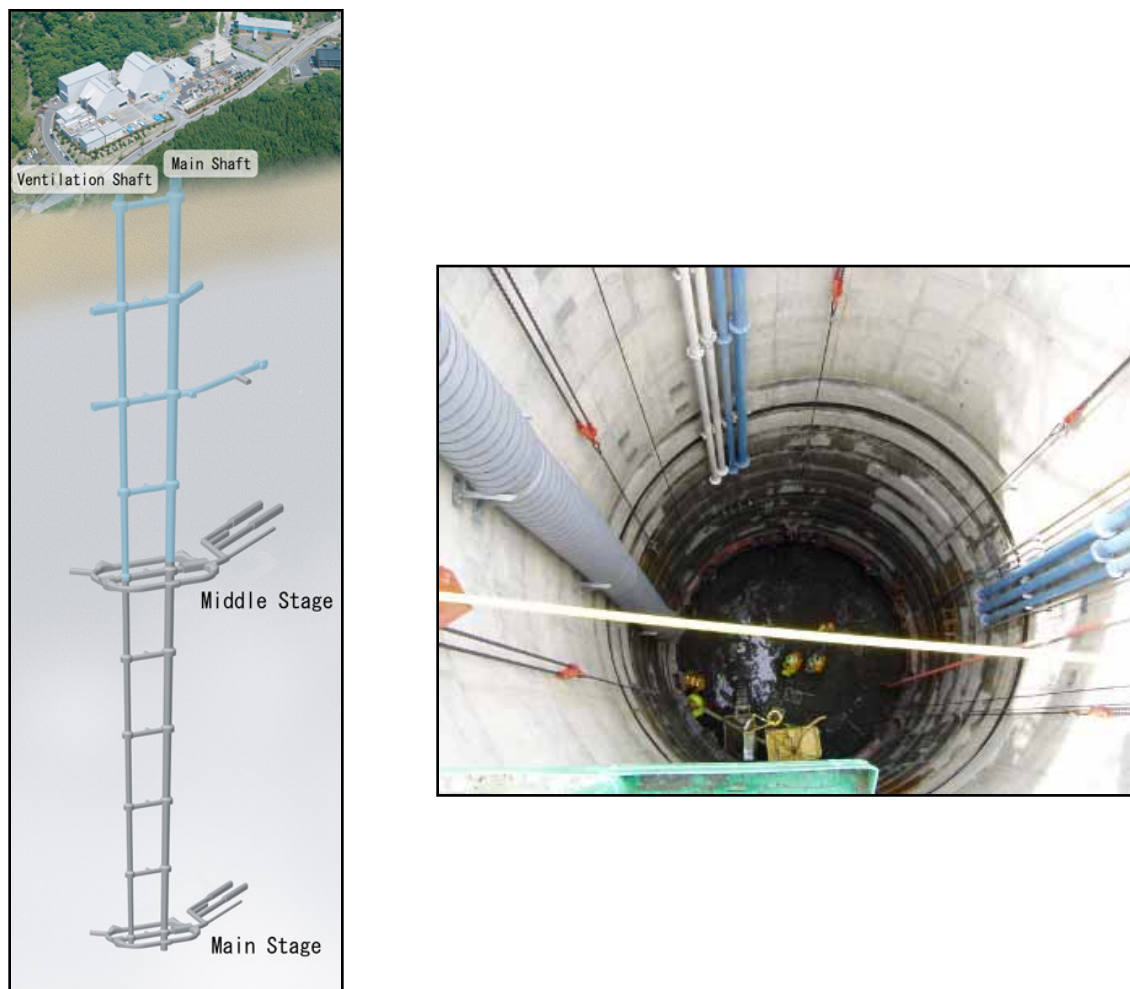

Figure 4.4-1 Layout of the Mizunami Underground Research Laboratory in Japan, and photo of tunnel shaft construction (http://www.jaea.go.jp/04/tono/miu_e/).

4.5 Collaboration Opportunities at HADES URL, Belgium

Belgium is another country with a strong R&D program in geologic disposal and a long history of experimental work in an underground research laboratory. The HADES (High Activity Disposal Experimental Site) URL is located in a secured area belonging to one of Belgium's nuclear power plants, which also hosts other nuclear research facilities. HADES is essentially a several-hundred-meter-long tunnel in the soft Boom Clay rock formation, accessible by two shafts located at each end (Figure 4.5-1). The tunnels were drilled in stages, starting with a first section in 1982, followed by additions in 1987 and 2001. Each of these sections was secured with different types of ground support, reflecting increased knowledge about the structural behavior of the host rock. Most interesting to DOE's program is probably the PRACLAY heater experiment, and to a lesser degree long-term clay diffusion experiments, both of which are discussed in more detail below. The Belgium organizations involved in conducting and interpreting these experiments have long-standing relationships with DOE/UFD scientists; they are open to participation with UFD research groups and have already invited researchers to provide THM modeling expertise to the PRACLAY project team. However, there are currently no joint activities related to the HADES URL.

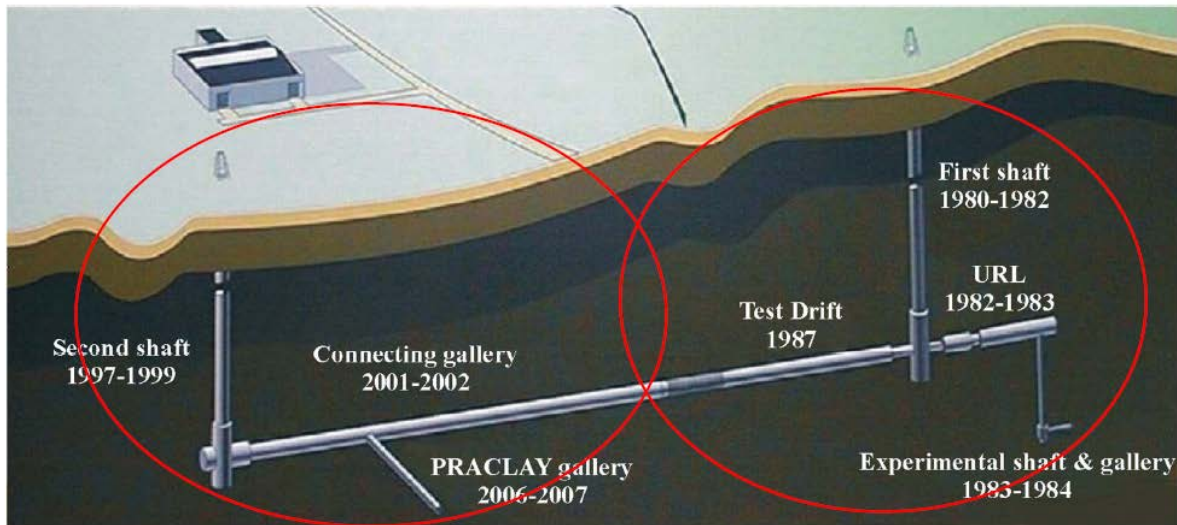

Figure 4.5-1 Layout of the HADES URL in Mol, Belgium (Li 2011).

4.5.1 PRACLAY Test

The PRACLAY Heater Test is a full-scale validation and confirmation experiment conducted at the HADES URL, excavated at 223 m depth in Boom Clay, a tertiary clay formation in Mol, Belgium. The heater test, which started its heating phase in January 2015, involves a 30 m gallery section heated for 10 years with many monitoring sensors (Figures 4.5-2, 4.5-3, and 4.5-4), for the purpose of investigating the thermo-hydro-mechanical (THM) behavior of near-field plastic clay under the most “mechanically critical” conditions that may occur around a repository (Van Marcke and Bastiaens 2010). For plastic clay under the influence of temperature change, these are undrained conditions, which then generate a higher pore-pressure increase and a higher possibility of near-field damage. For this objective, a hydraulic seal has been installed at the intersection between the planned heated and unheated sections of the gallery. This installation makes up the Seal Test, which was initiated in 2010, and allows for testing the functionality of the hydraulic seal under heated repository conditions.

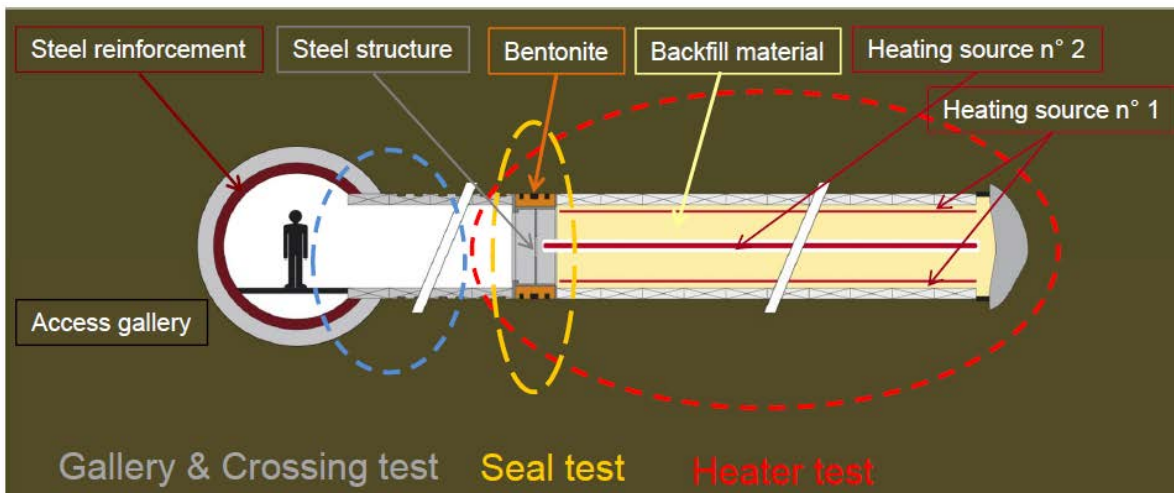

Figure 4.5-2 Layout of the PRACLAY *in situ* experiment at HADES URL (Li 2011).

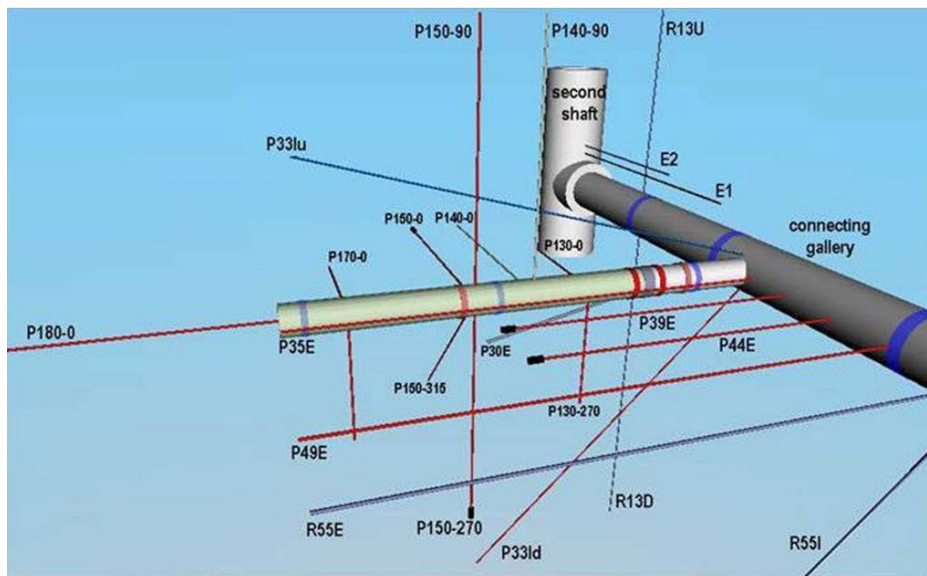

Figure 4.5-3 PRACLAY *in situ* experiment at HADES URL: Configuration of boreholes for pressure, stress, displacement, and water chemistry measurements (Li 2011).



Figure 4.5-4 PRACLAY *in situ* experiment at HADES URL: Photo on left shows hydraulic seal from the outside, with an access hole to the right, which soon will be closed. Photo on right was taken from access hole into the heater gallery section, which is currently being backfilled.

4.5.2 Radionuclide Migration Experiments

The Belgium waste management program has been conducting a suite of long-term radionuclide migration *in situ* experiments in dense clays at their HADES URL near Mol. Two of these experiments, named CP1 (Figure 4.5-5) and Tribicarb-3D, have been ongoing for 23 and 16 years, respectively, and offer valuable data on the slow diffusion-controlled migration of radionuclides in clay rock. Because of their duration, they offer unique test cases for model and process validation. Recently, two other ongoing large-scale migration experiments were initiated at HADES. The TRANCOM test involves colloid

transport with C-14 labeled humic substances. The RESEAL shaft seal experiment investigates transport of iodine-125 through the disturbed zone and the interface between Boom Clay and bentonite.

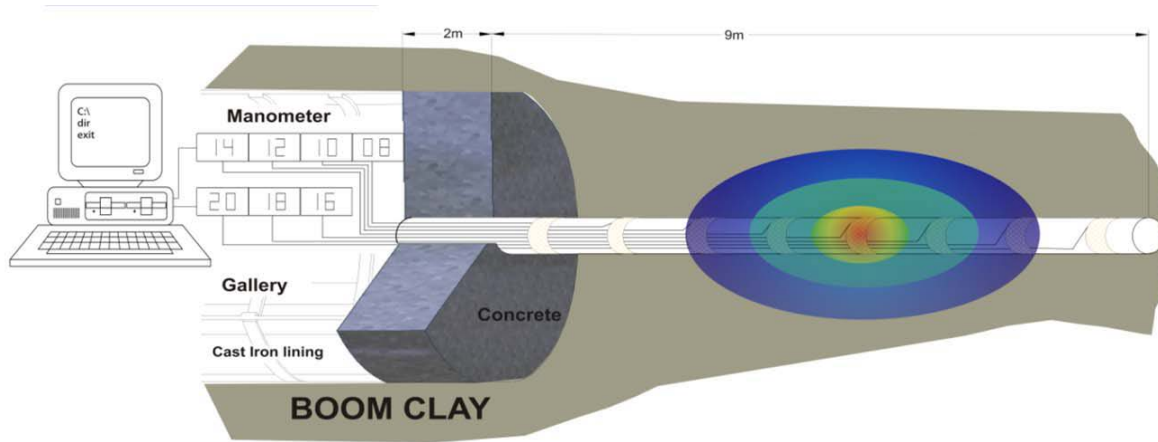

Figure 4.5-5 Schematic of CP1 Diffusion Experiment at HADES URL (Maes et al. 2011).

4.6 Collaboration Opportunities at Onkalo URL, Finland

The Onkalo URL in Finland is located at a site chosen to potentially co-host a repository. Thus, it is not only an underground research laboratory, but also an underground characterization facility. It is constructed in crystalline bedrock to the anticipated repository depth of 430–440 m. Construction began in 2004 and is ongoing, but actual underground tests were already started in 2007. Figure 4.6-1 shows the layout of the URL, with an access tunnel and three shafts. The access tunnel takes the form of a spiral on an approximately 1 in 10 incline downward, and reaches the technical facilities level at about 437 m. The three shafts consist of one personnel shaft and two ventilation shafts. Details may be found in Posiva (2011) and Aalto et al. (2009). There are currently no direct bilateral research activities between DOE and the Finnish waste management program related to the Onkalo URL. However, researchers from both countries are participating in the modeling interpretation of the REPRO diffusion experiment at Onkalo, which is a new modeling task conducted under the umbrella of the SKB GWFTS Task Force (see Section 3.4.2.2).

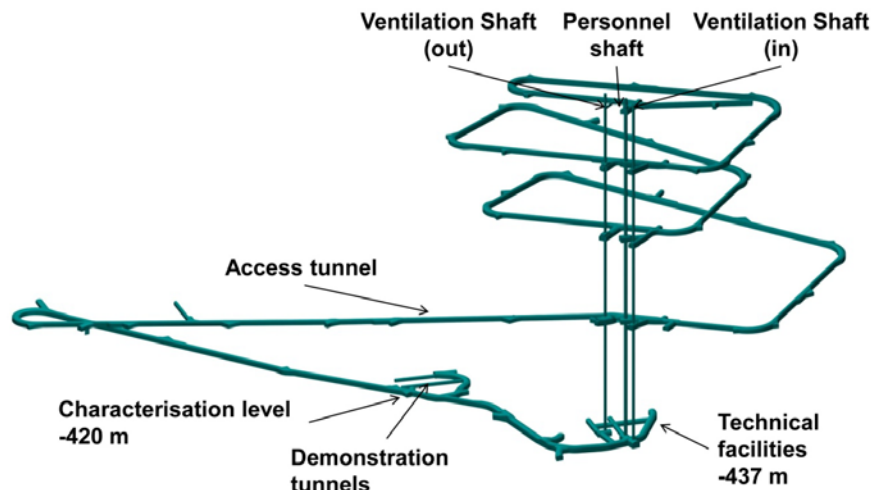

Figure 4.6-1 Layout of the Onkalo URL in Finland (Äikäs 2011).

4.7 Collaboration Opportunities with COSC, Sweden

The "Collisional Orogeny in the Scandinavian Caledonides" (COSC) project in Sweden is a scientific deep drilling project whose objective is to gain insights into the tectonic evolution of the area, characterize present and past deep fluid circulation patterns, determine current heat flow to constrain climate modeling, and characterize the deep biosphere. Another objective of this project is to calibrate high quality surface geophysics through deep drilling. The project is centered on the drilling of two deep boreholes (each to depth of ~2.5 km) into crystalline rock in Sweden. The first hole (COSC-1) was completed on August 26, 2014 to a depth of 2495.8 m: core recovery was greater than 99%. The COSC-1 borehole was drilled through the Seve Nappe, which contains high-grade metamorphic rocks indicative of deep (100 km) crustal levels (Figure 4.7-1). The main lithologies encountered consist of felsic, amphibolite, and calc-silicate gneisses, amphibolite, migmatites, garnet mica schist, with discrete zones of mylonite and microkarst. There is a transition from gneiss into lower grade metasedimentary rocks that occurs between 2345 and 2360 m, which likely marks a structural boundary between different nappes. In addition to drilling the well and collecting core, the research team also conducted pre-drilling and post-drilling seismic and other geophysical surveys, borehole geophysical logs, conducted on-site measurement on recovered cores, carried out systematic X-ray fluorescence (XRF) measurement on all cores at 10 cm intervals for key chemical compositions, and performed downhole spectral gamma ray (SGR) logging to determine U, Th and K contents all along the borehole.

DOE became aware of the COSC project through LBNL's Dr. Chin-Fu Tsang, who worked for many years in the Earth Sciences Division at LBNL and was active in the DOE's nuclear waste program from the Stripa project in Sweden to the Yucca Mountain Project in Nevada. It was recognized by UFD that the COSC project provided a valuable opportunity to test deep borehole characterization techniques in a crystalline basement environment. In FY15, BNL initiated an R&D program centered on fluid-logging testing using the first COSC borehole, and this work continued in FY16 (Section 6.3.2). The main objective of this project is analyze and understand data from the COSC-1 borehole as a case study for deep borehole characterization, with the goal to develop a better understanding of what information can be obtained from core and borehole measurements and what is the deep subsurface environment in granitic and other crystalline rocks in the context of nuclear waste disposal.

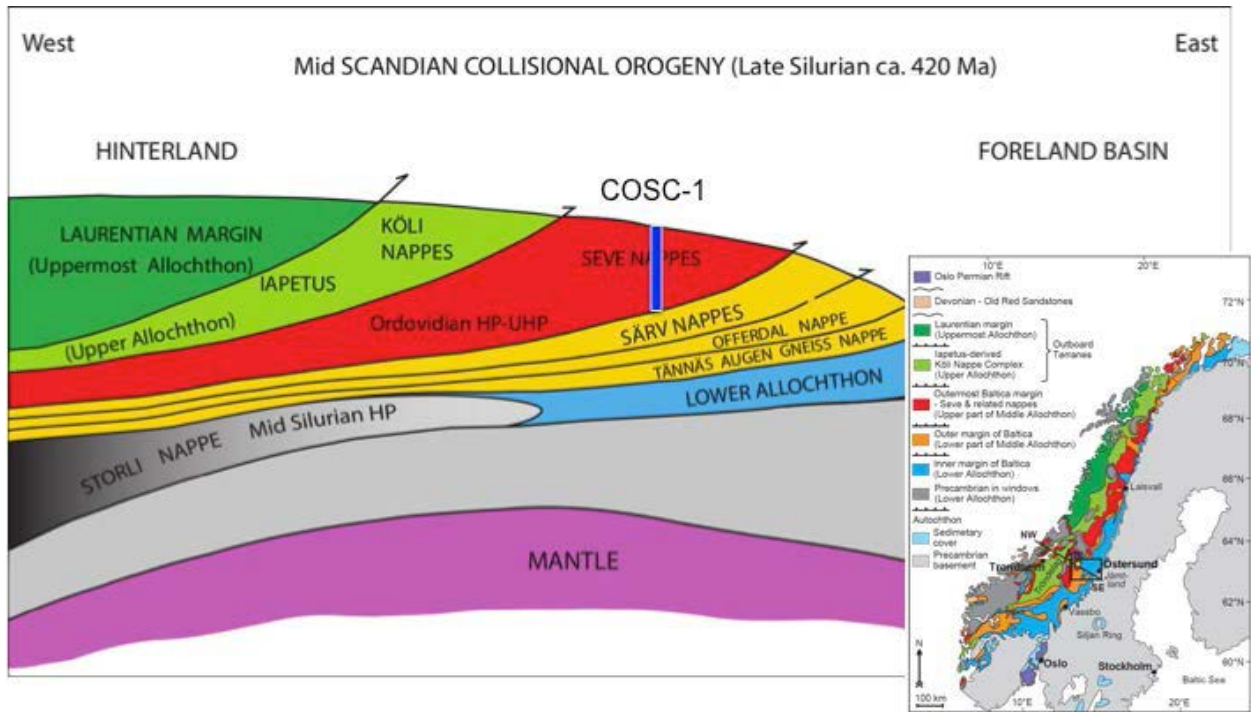

Figure 4.7-1 Location of COSC-1 deep borehole (Dobson et al., 2016).

5. SELECTION OF INTERNATIONAL COLLABORATION TASKS

As discussed in Section 3, DOE joined several multinational and multipartner initiatives that promote active international collaboration with specific focus on URL field experiments and related data: the DECOVALEX project, the Mont Terri Project, the Colloid Formation and Migration Project (until July 2015), the FEBEX-DP Project, and the SKB Task Forces (and is involved in planning another multinational initiative, the HotBENT Project, see Section 3.3.3.1). UFD researchers are in a position that allows participation in planning, conducting, and interpreting the many past and ongoing field experiments associated with these initiatives, and they do so in close collaborative partnership with international scientists. DOE also reached out to—and explored options of collaboration with—individual international disposal programs, such as the Republic of Korea’s KAERI, Germany’s BMWi, France’s ANDRA, Japan’s JAEA, Belgium’s SCK/CEN, and Finland’s POSIVA (Section 4), which have led to joint R&D projects with KAERI as well as German institutions on salt.

With many collaboration opportunities available to UFD, the campaign in FY12 started a planning exercise to identify the most relevant and promising ones, and to select and develop a set of activities that align with current goals, priorities, and funding plans of the UFD. In a general sense, the benefits of international collaboration are obvious: UFD can gain substantial value from the knowledge, data, and modeling capabilities that international partners have developed over decades of research. However, the benefit of international collaboration needs to be evaluated in the context of the open R&D issues that can be addressed through collaborative scientific activities. Open R&D issues with respect to NBS behavior are summarized in previous progress reports (e.g., *Natural System Evaluation and Tool Development – FY10 Progress Report, August 2010* (Wang 2010)); specific R&D issues related to clay/shale host rock are discussed, for example, in Tsang et al. (2011). EBS-related R&D items have also been considered in previous progress reports (e.g., Jove-Colon et al. 2010). All R&D gaps identified in these reports have been evaluated in consideration of their importance to the safety case in a roadmap exercise (*Used Fuel Disposition Campaign Disposal Research and Development Roadmap, FCRD-USED-2011-000065 Rev 0, March 2011; Tables 7 and 8; (Nutt 2011)*).

A summary table was developed in 2012 to provide a basis for planning and selection of international activities, and regular updates to this table have been prepared since then. As an example, Table 5-1 below shows the 2014 version of this summary table; it lists the most relevant ongoing or planned field experiments conducted in international URLs, provides information on how UFD participation can be achieved, which research areas would be the main benefactor (generally either the Engineered barrier System, EBS, or Natural Barrier System, EBS), the key FEPs addressed (including a link to roadmap and FEPs importance ranking; using the *Used Fuel Disposition Campaign Disposal Research and Development Roadmap, FCRD-USED-2011-000065 Rev 0, March 2011* [Nutt 2011]), and finally information on the experimental schedules.

Three workshops were held in FY11 and FY12 to inform the DOE leadership and UFD scientists about existing or future international opportunities, and align UFD work-package activities with international initiatives. The first workshop was a session held in conjunction with the UFD Working Group Meeting in Las Vegas, July 12–14, 2011, at this point mostly for informative purposes. The second workshop, held in Las Vegas on April 11, 2012, was a full-day meeting to review the current and planned work scope within UFD work packages for possible leveraging with the international programs, and to develop an initial set of R&D activities that align with goals, priorities, and funded plans of the UFD program. A third workshop was a session held in conjunction with the UFD Working Group Meeting in Las Vegas, May 15–17, 2012, to inform UFD researchers about the outcome of the full-day planning workshop, to present them with the collaboration options, and to initiate active R&D participation.

Today, three years after its initiation, the international disposal program within UFD has established a balanced portfolio of selected collaborative R&D activities in disposal science, addressing relevant R&D challenges and open research questions as follows:

- **Near-Field Perturbation:** How important is the near-field damage to a host rock (such as clay and salt) due to initial mechanical and thermal perturbation, and how effective is healing and sealing of the damage zone in the long term? How reliable are existing constitutive models describing the deformation of elastoplastic and plastic geomaterials as affected by temperature and water content changes?
- **Engineered Barrier Integrity:** What is the long-term stability and retention capability of backfills and seals? In a clay host rock, can bentonite mixtures be developed that allow for gas pressure release while maintaining sealing properties for water? In fractured granite, can bentonite be eroded when in contact with water from flowing fractures? How relevant are interactions between engineered and natural barrier materials, such as metal-bentonite-cement interactions?
- **Radionuclide Transport:** Can the radionuclide transport in fractured granites be predicted with confidence? What is the potential for enhanced transport with colloids? How can the diffusive transport processes in nanopore materials such as compacted clays and bentonites best be described? What is the effect of high temperature on the swelling and sorption characteristics of clays?
- **Demonstration of Integrated System Behavior:** Can the behavior of an entire repository system, including all engineered and natural barriers and their interaction, be demonstrated, and is the planned construction/emplacement method feasible?

Table 5-2 summarizes the FY16 portfolio of recent, ongoing or planned UFD activities related to relevant experiments in international URLs. As described in the following sections, this collaborative research portfolio has led to significant advances over the past years. The joint R&D with international researchers and the access to relevant data/experiments from a variety of URLs and host rocks have helped UFD researchers to significantly improve their understanding of the current technical basis for disposal in a range of potential host-rock environments and has contributed to testing and validating predictive computational models for evaluation of disposal-system performance in a variety of generic disposal-system concepts.

Over the years, as research priorities change, and as new opportunities for collaboration develop, UFD's international research portfolio has evolved and will continue to evolve. In FY15 and FY16, UFD made a targeted effort to re-evaluate its international collaboration activities, in a process similar to the initial planning phase in 2012. Two planning sessions each were held in conjunction with the recent UFD Working Group Meetings in Las Vegas on June 9-11, 2015 and June 7-9, 2016 to review existing and emerging opportunities for international collaboration, evaluate their technical merit and cost/benefit ratio, to align these opportunities with the current and planned work scope within UFD work packages for possible leveraging, and to develop a revised portfolio of international R&D activities that align with goals, priorities, and funded plans of the UFD program. For example, as a result of this process, UFD decided in FY15 to end its participation in the CFM Project because of its relatively narrow focus and relatively high participatory cost.

Another discussion point is whether DOE/UFD can and should move from a mostly participatory role in ongoing URL experiments conducted by other nations, to a more active role in developing its own experimental program specifically tailored to the DOE/UFD needs. Some collaborative initiatives like the Mont Terri Project or the Grimsel Test Site definitely provide the opportunity to involve partners, such as DOE, to take a leading role in developing new experimental projects. As mentioned earlier in this document, other international partners can be found if the proposed work aligns well with the interests of other Mont Terri or Grimsel Test Site partners. It is important to note in this context that the existing

infrastructure in these URLs developing and conducting experiments very easy, even if the proposing partner is located far away from the URL. At Mont Terri for example, Swisstopo can handle many of the organizational details if needed, and there is a long list of experienced contractors that are available to conduct the actual experimental work.

While there are no immediate plans for DOE to conduct its own experiments at international URLs of opportunity, UFD's disposal program is taking a more active approach in shaping the future R&D portfolio of the international initiatives it has joined as a partner. For example, with Jens Birkholzer of LBNL now the Chairman of the DECOVALEX-2019 Project, UFD scientists have been very influential in the project's current task selection. In addition, DOE has co-developed with international partners the planning and design of the HotBENT Project, a full-scale high-temperature heater experiment possibly conducted at the Grimsel Test Site a (Section 3.3.3.1). This experiment would be very important for UFD because of DOE's interest in the feasibility of direct geological disposal of large spent nuclear fuel canisters currently in dry storage (Hardin et al. 2014). Because of the large heat produced from such canisters, the important question arises whether clay-based barriers can withstand temperatures higher than the 100 °C threshold for bentonite performance usually assumed in advanced repository designs.

Table 5-1 Example of the 2014 Summary and Ranking Table of International Programs in Cooperative Initiatives Related to URLs: Status September 2014. The FEPs ranking is based on Tables 7 and 8 in Nutt (2011). Table entries are sorted by URLs.

URL	Relevant Ongoing or Planned Experiments (Selected)	Cooperation Mode	Main Focus	FEPs Ranking based on Tables 7 and 8 in Nutt (2011)	Test Period
Mont Terri, Switzerland (Opalinus Clay)	FE: Full-scale heater test demonstration experiment	Via Mont Terri Project	Both EBS and NBS NBS: Many aspects of near-field shale repository evolution, such as EDZ creation, desaturation and resaturation, thermal effects, pore-pressure increase after backfilling and heating EBS: Performance of EBS backfilling and lining technology	Geosphere FEPS (for shale): 2.2.01: Excavation Disturbed Zone (EDZ) >> High (Shale) 2.2.07: Mechanical Processes >> Medium (Shale) 2.2.08: Hydrologic Processes >> Medium (Shale) 2.2.11: Thermal Processes >> Medium (Shale) Engineered System FEPS: Buffer/Backfill materials 2.1.04.01: Buffer/Backfill >> High 2.1.07.02, .03., .04., .09: Mechanical Processes >> Medium 2.1.08.03, .07, .08: Hydrological Processes >> Medium 2.1.11.04: Thermal Processes >> Medium Engineered System FEPS: Seal/liner materials 2.1.05.01: Seals >> Medium 2.1.07.02, .08., .09: Mechanical Processes >> Medium 2.1.08.04, .05, .07, .08, .09: Hydrological Processes >> Low	Heating started in early 2015
Mont Terri, Switzerland	HE-E: Half-scale heater test in VE test section (VE = Ventilation Experiment)	Via DECOVALEX Project	Mostly EBS EBS: Non-isothermal resaturation behavior in bentonite backfill NBS: Interaction of near-field shale rock with EBS components	Geosphere (for shale): 2.2.01: Excavation Disturbed Zone (EDZ) >> High (Shale) 2.2.07: Mechanical Processes >> Medium (Shale) 2.2.08: Hydrologic Processes >> Medium (Shale) 2.2.11: Thermal Processes >> Medium (Shale) 2.2.09: Chemical Processes – Transport >> Medium-High Engineered System FEPS: Buffer/Backfill materials 2.1.04.01: Buffer/Backfill >> High 2.1.07.02, .03., .04., .09: Mechanical Processes >> Medium 2.1.08.03, .07, .08: Hydrological Processes >> Medium 2.1.11.04: Thermal Processes >> Medium	Heating phase: June 2011 through 2018
Mont Terri, Switzerland	MB: Mine-by Test for full-scale HM validation	Via Mont Terri Project	NBS Excavation-generated response in the argillaceous clay host rock near a mined tunnel, including changes in the near-field hydrologic properties	Geosphere FEPS (for shale): 2.2.01: Excavation Disturbed Zone (EDZ) >> High (Shale) 2.2.07: Mechanical Processes >> Medium (Shale) 2.2.08: Hydrologic Processes >> Medium (Shale)	2008 – 2009

URL	Relevant Ongoing or Planned Experiments (Selected)	Cooperation Mode	Main Focus	FEPs Ranking based on Tables 7 and 8 in Nutt (2011)	Test Period
Mont Terri, Switzerland	HG-A: Gas path host rock and seals	Via Mont Terri Project	Mostly NBS Investigation of EDZ as preferential flow path for gases generated from corrosion	Geosphere FEPS (for shale): 2.2.01: Excavation Disturbed Zone (EDZ) >> High (Shale) 2.2.08: Hydrologic Processes >> Medium (Shale) 2.2.12: Gas sources and effects >> Low	Ongoing since 2006 in various stages with hydraulic and gas injection tests
Mont Terri, Switzerland	DR-A: Diffusion, retention and perturbations	Via Mont Terri Project	NBS Long-term diffusion behavior of sorbing and non-sorbing radionuclides in clay	Geosphere FEPS (for shale) 2.2.05: Flow and Transport Pathways >> Medium (Shale) 2.2.08: Hydrologic Processes >> Medium (Shale) 2.2.09: Chemical Processes – Transport >> Medium (Shale)	2011 – 2013
Grimsel Test Site, Switzerland	CFM: RN tracer test	Via CFM Project	NBS Transport behavior of a tracer/radionuclide “cocktail” in a shear zone. Test includes conservative tracers, weakly sorbing solutes, strongly sorbing solutes and bentonite colloids	Geosphere FEPS (for crystalline rock) 2.2.05: Flow and Transport Pathways >>> Medium (Crystalline) 2.2.08: Hydrologic Processes >> Low (Crystalline) 2.2.09: Chemical Processes – Transport >> Medium (Crystalline)	Several tests in 2009 through 2012
Grimsel Test Site, Switzerland	CFM: RN-Doped Plug Experiment	Via CFM Project	NBS: Similar to above test, but this time involving at radionuclide-doped bentonite plug which erodes and induces colloid-facilitated transport	Geosphere FEPS (for crystalline rock) 2.2.05: Flow and Transport Pathways >>> Medium (Crystalline) 2.2.08: Hydrologic Processes >> Low (Crystalline) 2.2.09: Chemical Processes – Transport >> Medium (Crystalline) Engineered System FEPS: Buffer/backfill materials 2.1.04.01: Buffer/Backfill >> High 2.1.09.51-59, .61: Chemical Processes –Transport >> Low to Medium	Started in May 2014
Grimsel Test Site, Switzerland	FEBEX-DP: Full-scale heater test dismantling project	Via FEBEX-DP Project	Mostly EBS Long-term performance of the bentonite backfill and, to a lesser degree, the near-field crystalline rock, with emphasis on the thermal evolution and resaturation of bentonite backfill surrounding a heated waste package	Engineered System FEPS: Buffer/Backfill materials 2.1.04.01: Buffer/Backfill >>> High 2.1.07.02, .03, .04, .09: Mechanical Processes >> Medium 2.1.08.03, .07, .08: Hydrological Processes >> Medium 2.1.11.04: Thermal Processes >> Medium Geosphere FEPS (for crystalline rock) 2.2.01: Excavation Disturbed Zone (EDZ) >>> Medium (Crystalline) 2.2.07: Mechanical Processes >> Low (Crystalline) 2.2.08: Hydrologic Processes >> Low (Crystalline) 2.2.11: Thermal Processes >> Low (Crystalline)	Heater test ongoing since 1997; dismantling conducted in Summer 2015

URL	Relevant Ongoing or Planned Experiments (Selected)	Cooperation Mode	Main Focus	FEPs Ranking based on Tables 7 and 8 in Nutt (2011)	Test Period
Grimsel Test Site, Switzerland	GAST: Gas permeable seal experiment	Possibly via MoU with NAGRA	EBS Demonstrate the performance of repository seals and to improve the understanding of water and gas transport through these sealing systems. The experiment involves specially designed backfill and sealing materials such as high porosity mortars or sand/bentonite (S/B) mixtures.	Engineered System FEPs: Buffer/Backfill materials 2.1.04.01: Buffer/Backfill >> High 2.1.08.03, .07, .08: Hydrological Processes >> Medium 2.1.12.01, .02, .03: Gas sources and effects >> Medium	2010 – 2015
Äspö Hard Rock Laboratory, Sweden	BRIE: Bentonite rock interaction experiment	Via SKB Task Forces	Both NBS and EBS Understand the exchange of water and potential bentonite erosion at the interface between backfill and flowing fractures	Engineered System FEPs: Buffer/Backfill materials 2.1.04.01: Buffer/Backfill >> High 2.1.08.03, .07, .08: Hydrological Processes >> Medium Geosphere FEPs (for crystalline rock) 2.2.05: Flow and Transport Pathways >> Medium (Crystalline) 2.2.08: Hydrologic Processes >>Low (Crystalline)	Ongoing since 2012
Äspö Hard Rock Laboratory, Sweden	LTDE-SD: Long-term sorption diffusion experiment	Via SKB Task Forces	NBS Diffusion and sorption in a conducting fracture and adjacent matrix (sorbing and non-sorbing tracers)	Geosphere FEPs (for crystalline rock) 2.2.05: Flow and Transport Pathways >> Medium (Crystalline) 2.2.08: Hydrologic Processes >>Low (Crystalline) 2.2.09: Chemical Processes – Transport >> Medium (Crystalline)	Completed in 2010 with 6 months test duration
Äspö Hard Rock Laboratory, Sweden	Prototype Repository: full-scale prototype tunnels with six deposition holes	Via SKB Task Forces	Mostly EBS, also NBS Demonstration of the integrated function of the repository and a full-scale reference for test of predictive models concerning individual components as well as the complete repository system. Includes heaters and backfill.	Geosphere FEPs (for shale): 2.2.01: Excavation Disturbed Zone (EDZ) >> High (Shale) 2.2.07: Mechanical Processes >> Medium (Shale) 2.2.08: Hydrologic Processes >> Medium (Shale) 2.2.11: Thermal Processes >> Medium (Shale) Engineered System FEPs: Buffer/Backfill materials 2.1.04.01: Buffer/Backfill >> High 2.1.07.02, .03, .04, .09: Mechanical Processes >> Medium 2.1.08.03, .07, .08: Hydrological Processes >> Medium 2.1.11.04: Thermal Processes >> Medium	Since 2001. Outer test section opened and retrieved in 2011.

URL	Relevant Ongoing or Planned Experiments (Selected)	Cooperation Mode	Main Focus	FEPs Ranking based on Tables 7 and 8 in Nutt (2011)	Test Period
Tournemire, France	SEALEX: Long-time sealing experiment for different materials	Via DECOVALEX	Mostly EBS Long-term isothermal HM© behavior and hydraulic performance of swelling clay-based seals	Engineered System FEPS: Seal/liner materials 2.1.05.01: Buffer/Backfill >> Medium 2.1.07.02, .08., .09: Mechanical Processes >> Medium 2.1.08.04, .05, .07, .08, .09: Hydrological Processes >> Medium (Flow through seals) 2.1.09.01, .03, .09, .13: Chemical Processes – Chemistry >> Medium	2011 – 2015
Bedrichov Tunnel, Czech Republic	Flow patterns and tracer transport in fractured granite	Via DECOVALEX	NBS Flow patterns and tracer transport behavior within fractured crystalline rock	Geosphere (for crystalline rock): 2.2.02: Host Rock Properties >> High (Crystalline) 2.2.05: Flow and Transport Pathways >> Medium (crystalline) 2.2.08: Hydrologic Processes >> Medium (Crystalline)	Hydrogeologic characterization and monitoring ongoing
Horonobe URL, Japan	EBS experiment: Vertical heater and buffer test (planned)	Via DECOVALEX	Mostly EBS EBS: Non-isothermal resaturation behavior in bentonite backfill NBS: Interaction of near-field shale rock with EBS components	Geosphere (for shale): 2.2.01: Excavation Disturbed Zone (EDZ) >> High (Shale) 2.2.07: Mechanical Processes >> Medium (Shale) 2.2.08: Hydrologic Processes >> Medium (Shale) 2.2.11: Thermal Processes >> Medium (Shale) Engineered System FEPS: Buffer/Backfill materials 2.1.04.01: Buffer/Backfill >> High 2.1.07.02, .03., .04., .09: Mechanical Processes >> Medium 2.1.08.03, .07, .08: Hydrological Processes >> Medium 2.1.11.04: Thermal Processes >> Medium	Start of heating phase in late 2014
KURT URL, Korea	Streaming potential (SP) testing and correlation with groundwater flow	Via MoU with KAERI	NBS: Flow patterns in fractured crystalline rock	Geosphere (for crystalline rock): 2.2.02: Host Rock Properties >> High (Crystalline) 2.2.05: Flow and Transport Pathways >> Medium (crystalline) 2.2.08: Hydrologic Processes >> Medium (Crystalline)	<i>In situ</i> testing will be conducted once the KURT extension is complete
KURT URL, Korea	Development of techniques for <i>in situ</i> borehole characterization and monitoring	Via MoU with KAERI	NBS: Relevance to deep borehole disposal	Geosphere FEPS (for borehole): 2.2.01: Excavation Disturbed Zone (EDZ) >> High (Borehole) 2.2.07: Mechanical Processes >> Low (Borehole) 2.2.08: Hydrologic Processes >> Medium (Borehole) 2.2.11: Thermal Processes >> Medium (Borehole) 2.2.09: Chemical Processes – Chemistry >> Medium-High (Borehole) 2.2.09: Chemical Processes – Transport >> Medium-High (Borehole) 2.2.02: Host Rock (properties) >> High (Borehole) 2.2.05: Flow and Transport Pathways >> Medium (Borehole)	Ongoing

URL	Relevant Ongoing or Planned Experiments (Selected)	Cooperation Mode	Main Focus	FEPs Ranking based on Tables 7 and 8 in Nutt (2011)	Test Period
HADES URL, Belgium	PRACLAY: Full-scale seal and heater experiment	Possibly via bilateral collaboration with SCK/CEN	Mostly NBS Many aspects of near-field boom clay repository evolution, such as EDZ creation, desaturation and resaturation, thermal effects, pore-pressure increase after backfilling and heating	Geosphere FEPS (for shale): 2.2.01: Excavation Disturbed Zone (EDZ) >> High (Shale) 2.2.07: Mechanical Processes >> Medium (Shale) 2.2.08: Hydrologic Processes >> Medium (Shale) 2.2.11: Thermal Processes >> Medium (Shale)	Heating started January 2015
HADES URL, Belgium	RN Migration: Long-running RN diffusion tests	Possibly via bilateral collaboration with SCK/CEN	NBS Diffusion-controlled migration of radionuclides in clay rocks	Geosphere FEPS (for shale) 2.2.05: Flow and Transport Pathways >> Medium (Shale) 2.2.09: Chemical Processes – Transport >> Medium (Shale)	Ongoing since more than two decades

Table 5-2 Recent, Current and Future Work Package Activities with International Collaboration and Focus on URL Experiments (sorted by URL)

URL	Relevant Ongoing or Planned Experiments (Selected)	Cooperation Mode	UFD Participation
Mont Terri, Switzerland (Opalinus Clay)	<ul style="list-style-type: none"> FE: Full-scale heater test demonstration experiment <ul style="list-style-type: none"> HE-E: Half-scale heater test in VE test section <ul style="list-style-type: none"> HG-A: Gas path host rock and seals EB: Engineered Barrier Experiment FS: Fault Slip Experiment 	<ul style="list-style-type: none"> Mont Terri Project DECOVALEX-2015 Mont Terri Project DECOVALEX-2019 DECOVALEX-2019 	<ul style="list-style-type: none"> LBNL (Ongoing) LBNL (Complete) LBNL (Complete) LBNL (Planned) LBNL (Planned)
Grimsel Test Site, Switzerland (Granite)	<ul style="list-style-type: none"> CFM: RN tracer test and RN-doped plug experiment FEBEX-DP: full-scale heater test dismantling <ul style="list-style-type: none"> HotBENT: high-temperature heater test 	<ul style="list-style-type: none"> CFM FEBEX-DP HotBENT 	<ul style="list-style-type: none"> LANL, LLNL (Complete) SNL, LBNL (Ongoing) LBNL (Planned)
Äspö Hard Rock Laboratory, Sweden (Granite)	<ul style="list-style-type: none"> BRIE: Bentonite rock interaction experiment LTDE-SD and REPRO (Diffusion-Advection-Sorption) 	<ul style="list-style-type: none"> SKB Task Forces SKB Task Forces 	<ul style="list-style-type: none"> LANL (Complete) LANL (Ongoing)
Mizunami, Japan (Granite)	<ul style="list-style-type: none"> GREET: Groundwater Recovery Experiment 	<ul style="list-style-type: none"> DECOVALEX-2019 	<ul style="list-style-type: none"> SNL (Planned)
Bedrichov Tunnel, Czech Rep. (Granite)	<ul style="list-style-type: none"> Flow patterns and tracer transport in fractured granite 	<ul style="list-style-type: none"> DECOVALEX-2015 	<ul style="list-style-type: none"> SNL (Complete)
Horonobe URL, Japan (Sedimentary rock)	<ul style="list-style-type: none"> EBS experiment: Vertical heater and buffer test (planned) 	<ul style="list-style-type: none"> DECOVALEX-2015 	<ul style="list-style-type: none"> LBNL (Complete)
KURT URL, Korea (Crystalline rock)	<ul style="list-style-type: none"> Streaming potential (SP) testing Techniques for <i>in situ</i> borehole characterization 	<ul style="list-style-type: none"> MoU KAERI MoU KAERI 	<ul style="list-style-type: none"> SNL (Complete) SNL (Ongoing)
LSMHM URL, France (COX Clay)	<ul style="list-style-type: none"> TED Heater Test ALC Heater Test 	<ul style="list-style-type: none"> DECOVALEX-2019 DECOVALEX-2019 	<ul style="list-style-type: none"> LBNL (Planned) LBNL (Planned)
WIPP, U.S. (Bedded Salt)	<ul style="list-style-type: none"> Room B and D experiments 	<ul style="list-style-type: none"> MoU BMWi, Germ. 	<ul style="list-style-type: none"> SNL (Ongoing)
Asse Mine, Germany (Domal Salt)	<ul style="list-style-type: none"> TDSE Heater Test 	<ul style="list-style-type: none"> Bilateral Coll. 	<ul style="list-style-type: none"> LBNL (Completed)

This page is intentionally blank.

6. STATUS OF INTERNATIONAL COLLABORATION ACTIVITIES WITH FOCUS ON URL EXPERIMENTS

Here we give a brief description of ongoing international collaboration activities involving UFD scientists. This section is dedicated to R&D work with primary focus on participation in, and analysis of, URL experiments. We start with research addressing issues related to near-field perturbation and engineered barrier integrity (Section 6.1), followed by R&D research of fluid flow and radionuclide transport processes in the host rock (Section 6.2), and collaborative research to develop new characterization and monitoring methods (Section 6.3). Examples of R&D results will be presented, albeit without providing exhaustive explanations; we intend to merely illustrate technical achievements made in various areas. All necessary detail can be found in the references cited in the text and given a list of references. International collaboration activities unrelated to URLs are briefly described in Section 7.

6.1 Near-Field Perturbation and EBS Integrity

6.1.1 THM Modeling of Heater Experiments

6.1.1.1 *Introduction*

On behalf of DOE, LBNL has been heavily involved in understanding and predicting the complex coupled processes related to the thermal perturbations after emplacement of waste in clay-based engineered and natural barriers (bentonite buffer materials and clay host rock). To test new advanced methods for the rigorous THM modeling of behavior of swelling soils/rocks against large-scale heater experiments, LBNL in the DECOVALEX-2015 Project since 2012 as one of the international modeling teams working on Task B1, the HE-E Heater Test at Mont Terri (Sections 3.1.3 and 3.2.2.2), and Task B2, the Horonobe Engineered Barrier Experiment (Section 3.2.2.3). The DECOVALEX-2015 Project ended December 2015; thus LBNL's FY16 work finalizes the four-year effort on Tasks B1 and B2. LBNL has also been contributing to the design and scoping simulations for the FE Heater Test at Mont Terri and has recently used monitoring data from the first 400 days of heating to validate the initial predictions (Section 3.1.2). LBNL's work on the FE Heater Test will continue in future years.

As described in the milestone reports Zheng et al. (2015) and Zheng et al. (2016), the TOUGH-FLAC simulator developed at LBNL has been the primary modeling tool for the heater test analysis, because this simulator has the required capabilities to model multiple problems associated with nuclear waste disposal for various engineered and natural systems. TOUGH-FLAC can simulate coupled THM processes under multiphase flow conditions through a sequential coupling of the TOUGH2 multiphase flow simulator with the FLAC3D geomechanical code (Rutqvist et al. 2002; Rutqvist 2011; Rutqvist 2016). As part of the UFD R&D program, TOUGH-FLAC has been modified for applications related to bentonite-backfilled repositories in clay host formations (Rutqvist et al. 2014a; Rutqvist 2016). Major improvements include implementation of the Barcelona Basic Model (BBM) for the rigorous THM modeling of behavior of swelling soils and applied to modeling of bentonite backfill behavior (Alonso et al. 1990). The BBM model can describe many typical features of unsaturated-soil mechanical behavior, including wetting-induced swelling or collapse strains, depending on the magnitude of applied stress, as well as the increase in shear strength and apparent preconsolidation stress with suction (Gens et al. 2006).

Recently, the BBM has been extended to a dual-structure model, referred to as the Barcelona Expansive Model (BExM), as described by Vilarrasa et al. (2015). In a dual-structure model, the material consists of two structural components: a microstructure, in which the interactions occur at the particle level, and a

macrostructure that accounts for the overall fabric arrangement of the material comprising aggregates and macropores (Gens et al. 2006, Sánchez et al. 2005). A dual-structure model has important features for modeling the mechanical behavior of a bentonite buffer, such as irreversible strain during suction cycles. However, most importantly, a dual-structure model provides the necessary link between chemistry and mechanics, enabling one to develop a coupled THMC model for the simulation of the long-term EBS behavior. This approach enables mechanistic modeling of processes important for long-term buffer stability, including effects of pore-water salinity on swelling (loss of swelling), conversion of smectite to nonexpansive mineral forms (loss of swelling), and swelling pressure versus exchangeable cations (Rutqvist et al. 2014c). A detailed description of the dual structure approach is given in Section 2.2.1 of the FY16 milestone report Zheng et al. (2016).

6.1.1.2 Modeling of Mont Terri HE-E Experiment – DECOVALEX Task B1

DECOVALEX-2015 Task B1 included several heater test modeling steps of increasing complexity (Section 3.2.2.2): (1) the study of THM processes in the argillaceous host rock, using data from an earlier borehole heater test (HE-D experiment) at Mont Terri; (2) the study of THM processes in the buffer materials, using data from laboratory experiments (CIEMAT Column Experiments), and (3) the study of the ongoing HE-E experiment considering the host rock as well as the buffer material, initially as a predictive exercise, then as an interpretative effort with comparison to monitoring data (Garitte and Gens 2012). Regarding the HE-E experiment, the main objective was to test model capabilities addressing the evolution of EBS components and the near-field Opalinus Clay in the early post-closure perturbation period, with emphasis on thermal evolution, resaturation, and evolution of swelling pressure in bentonite backfill.

The first step of modeling the HE-D experiment had been conducted from 2012 until November 2013. LBNL's modeling of the HE-D experiment and comparison of the TOUGH-FLAC modeling results to those of other DECOVALEX modeling teams were reported in the FY2013 milestone report by Rutqvist et al. (2013). The second step, a study of bentonite properties through modeling of laboratory experiments, was completed in FY14 and was described in the FY14 milestone report by Zheng et al. (2014). The predictive and interpretive modeling of the HE-E experiment (the final step of Task B1) was finalized this year; details on the preliminary and final model comparison results are given in the milestone reports by Zheng et al. (2015; 2016). Below, we provide a brief description of the LBNL modeling studies conducted for the final and most complex step in Task B1, the HE-E experiment.

As described in Section 3.1.3, the Mont Terri HE-E Experiment has focused on the THM behavior of bentonite barriers in the early nonisothermal resaturation stage and their THM interaction with Opalinus Clay. The objective was to better understand the evolution of a disposal system for high-level waste in the early post-closure period, with emphasis on the thermal evolution, buffer resaturation (in situ determination of the thermal conductivity of bentonite and its dependency on saturation), pore-water pressure in the near field, and the evolution of swelling pressures in the buffer (Gaus et al. 2014). Similar to other seven modeling teams involved in this DECOVALEX task, the LBNL team first conducted a predictive analysis of the HE-E experiment, before the field data were made available to the DECOVALEX-2015 participants, followed by a comparison of the initial model predictions with experimental results.

Figure 6.1-1 shows the location of the HE-E experiment within the Mont Terri URL and the LBNL's 3-D model grid used for modeling of the HE-E. The model is a half symmetric with a vertical symmetry plane along the tunnel axis. In the model, the relevant fractured rock materials are represented, including different bentonite materials. The most important thermal and hydraulic properties were derived from

literature data and from material properties estimated by modeling of various THM laboratory experiments on bentonite.

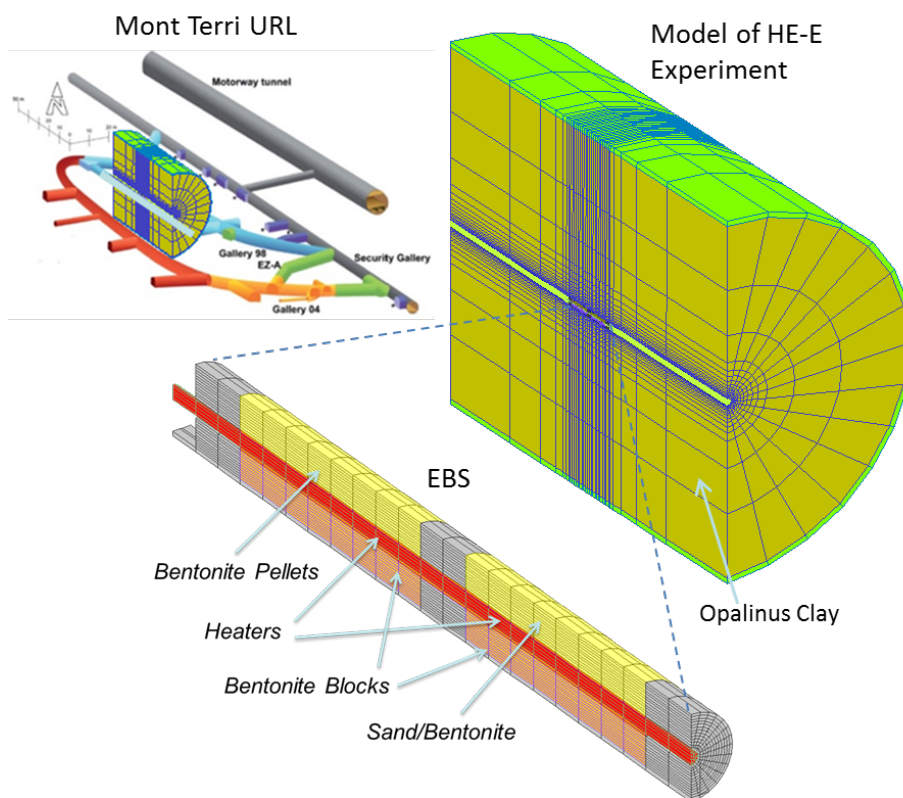

Figure 6.1-1 TOUGH-FLAC 3-D model of the Mont Terri HE-E experiment (Zheng et al. 2015).

Below we show some example results illustrating the LBNL's modeling results in comparison with the measurements as well as with other modeling teams participating in this DECOVALEX task. Predicted (by LBNL) and observed temporal trends of relative humidity and temperature are shown in Figure 6.1-2. The figure shows that the humidity behavior of the bentonite at the rock wall and drying of the inner parts of the bentonite buffer is generally captured well in the modeling, showing that the hydration of the bentonite is well represented in the TOUGH-FLAC model. Model results for relative humidity, which is related to saturation, are in a good agreement with measurements close the rock wall (shown by a blue curve) and close to the heater (shown by a red curve). However, the model overestimates relative humidity in the mid part of the bentonite buffer (green curve). A study to identify possible reasons for this discrepancy showed no significant effects of the buffer absolute and relative permeability and diffusion coefficient. A possible reason is the effect of the water retention curve, which might have caused deviations from the experimental data at low saturation. Nevertheless, the overall evolution of relative humidity is reasonably predicted by the modeling.

Figure 6.1-3 shows the evolution of fluid pressure within the Opalinus Clay at a monitoring point located 3.54 m from the tunnel wall. This increase in fluid pressure is a result of so-called thermal pressurization, caused by thermal expansion of the pore fluid that cannot escape in the relatively low-permeability host rock. The magnitude and duration of this excess pressure pulse depends on parameters such as rock permeability and compressibility of water and rock (Rutqvist et al. 2014b). Using the Opalinus Clay

properties determined from the earlier modeling of the HE-D experiments, it appears that the model could predict this pressure increase fairly well. However, when considering the initial pressure, one can observe some more deviation between modeling and measurements.

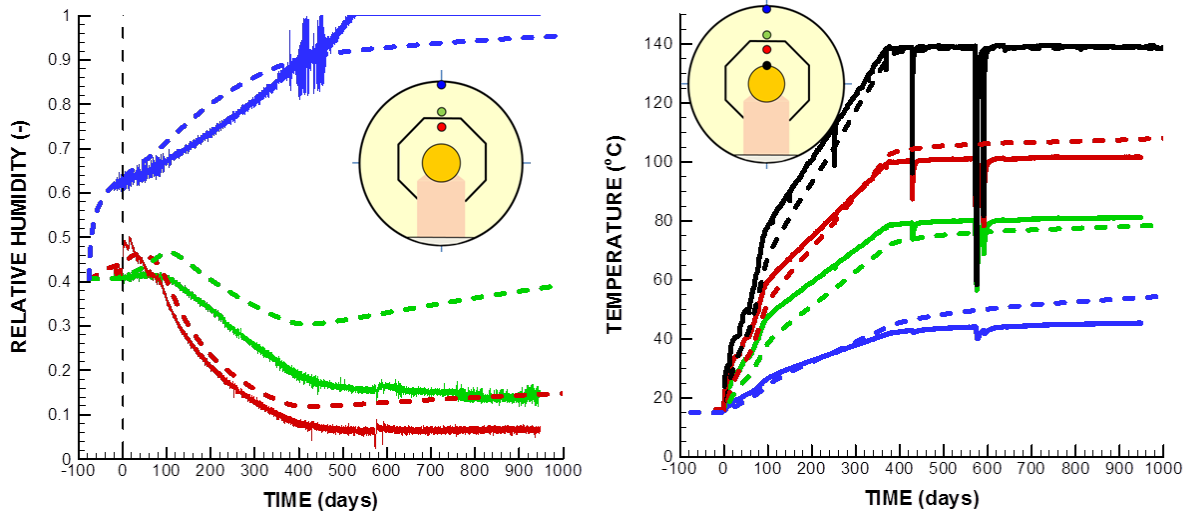

Figure 6.1-2 Comparison of simulated (dashed lines) and measured (solid lines) evolutions of (a) liquid saturation relative humidity and (b) temperature after interpretative modeling (Zheng et al. 2016).

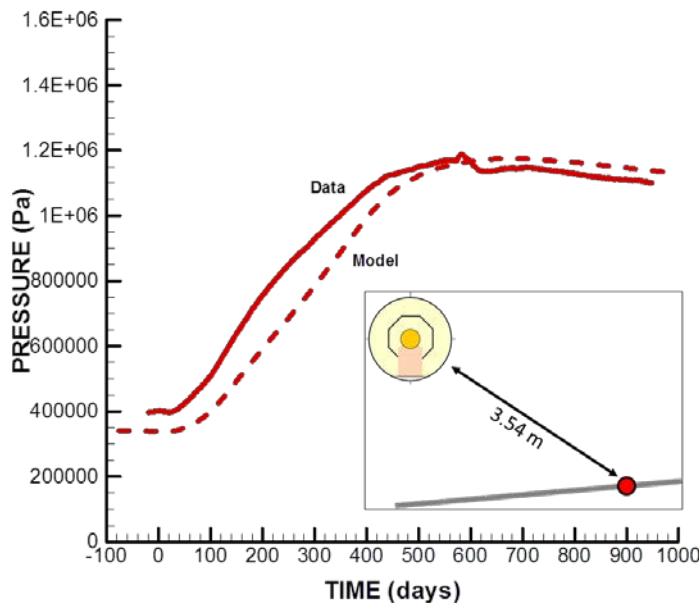

Figure 6.1-3 Comparison of modeled (dashed lines) and measured (solid lines) evolutions of pore pressure in Opalinus Clay at located 3.54 m from the tunnel after interpretative modeling (Zheng et al. 2016).

The following Figure 6.1-4 illustrates the working model with the DECOVALEX Project, where several international modeling teams analyze and simulate the same experimental data set. Here we look at a comparison of the modeling predictions by eight DECOVALEX-2015 modeling teams with measured data at different locations within granular bentonite and bentonite blocks. The results show good agreement between most models and measurements, though there are some distinct differences between the simulated relative humidity trends. Comparing results from different modeling teams and evaluating the rationale for differences in these results can help understanding model uncertainty and can lead to the improvement of conceptual models.

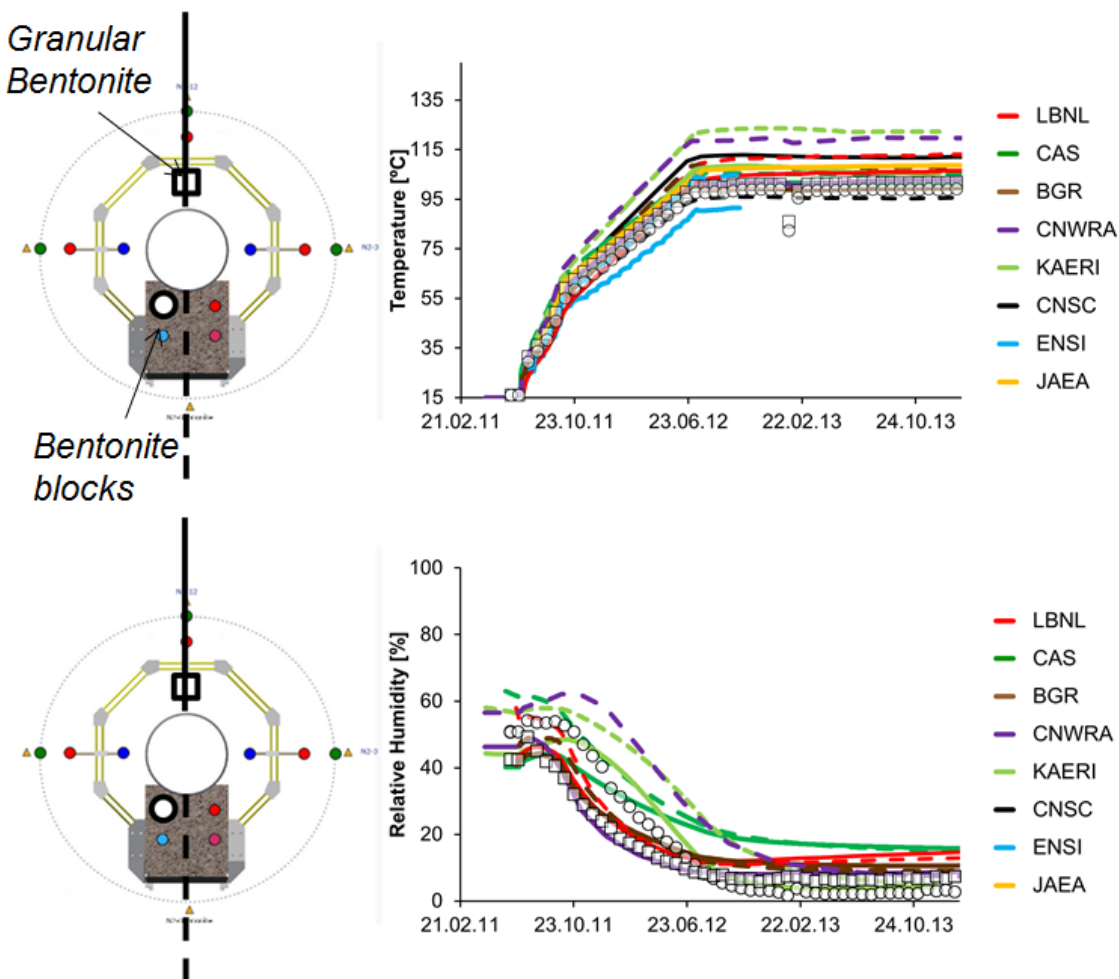

Figure 6.1-4 Comparison of predicted (lines) and measured (symbols) evolutions of temperature and relative humidity at points located 10 cm (in granular bentonite, white square in left figures) and 7 cm (in bentonite blocks, bigger white circle in left figures)) for eight modeling teams within the DECOVALEX-2015 project. Solid lines for modeling results in granular bentonite and dashed lines for modeling results in bentonite blocks (Zheng et al. 2016).

6.1.1.3 Modeling of the Horonobe EBS experiment – DECOVALEX Task B2

The DECOVALEX-2015 Task B2 involved coupled THMC modeling of a recently initiated full-scale EBS experiment conducted by the Japan Atomic Energy Agency (JAEA) at the Horonobe URL in Japan (Section 3.2.2.3). As a first modeling step, participating teams were asked to simulate a simplified 1D benchmark test with exact properties and boundary conditions given by the JAEA. This step allowed teams to get familiar with the problem setup and to conduct an initial model comparison for a simpler test problem before simulating the complex full-scale EBS experiment. Modeling teams then moved an initial “blind” model predictions for the full-scale Horonobe EBS experiment (Step 2), ultimately followed by a calibration analysis using the first 75 of monitoring data during the heating period (Step 3). Results of the initial benchmarking are reported in Rutqvist et al. (2013) and Zheng et al. (2014); the “blind” prediction and calibration steps are described in Zheng et al. (2015; 2016). Below we give a few examples of the Steps 2 and 3 conducted by LBNL.

To conduct the predictive and interpretative simulations for the Horonobe EBS experiment, the LBNL team developed a half symmetric 3D model, which includes half of the tunnel and half of the deposition hole (Figure 6.1-5), and explicitly represents all relevant materials, including mudstone rock, buffer, backfill, a sand layer at the rock/buffer interface, concrete lining, and plug. Predictive simulations of the expected THM response were conducted by all teams for a heating period of about two years. Selected results of temperature evolution are shown in Figures 6.1-6 for points located in the buffer and near-field rock. When keeping the heater temperature constant at 100°C, the simulation shows that the temperature at the buffer-rock interface (P3, P4 in Figure 6.1-6) increases to about 60°C after two years. In addition to LBNL’s prediction, four other international modeling teams participated in Task B2, namely BGR from Germany, CAS from China, KAERI from Korea, and JAEA. The predictive results obtained by all the DECOVALEX-2015 modeling teams have been compared to each other, as shown in Figure 6.1-7 for the evolution of temperature. The results are quite consistent and in good agreement between the modeling teams, though some outliers can be observed.

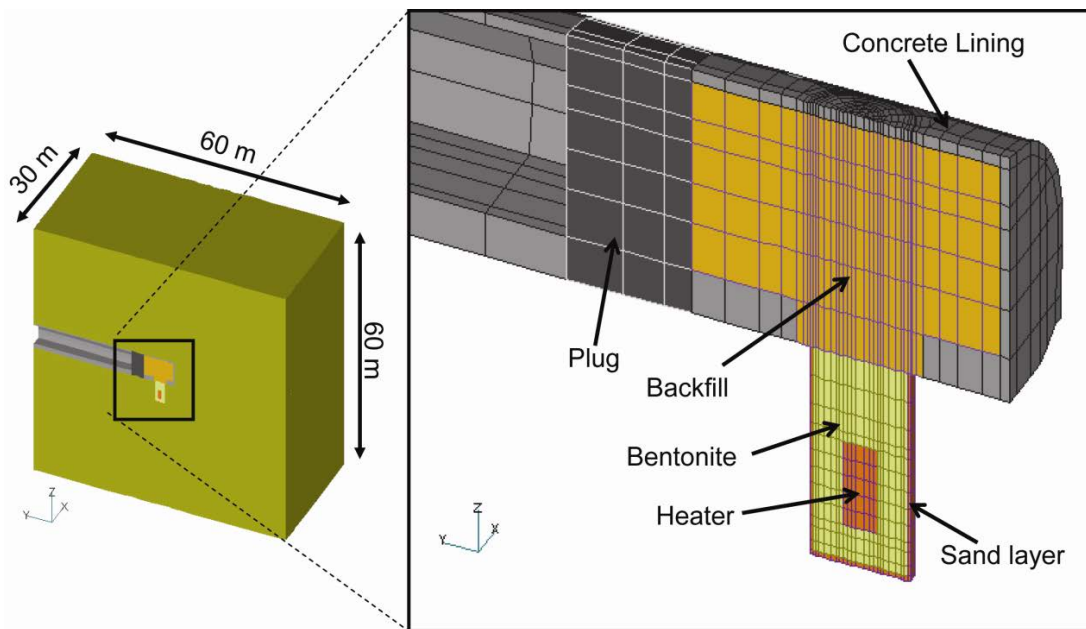

Figure 6.1-5 TOUGH-FLAC 3D numerical grid of the Horonobe EBS experiment (Zheng et al. 2016).

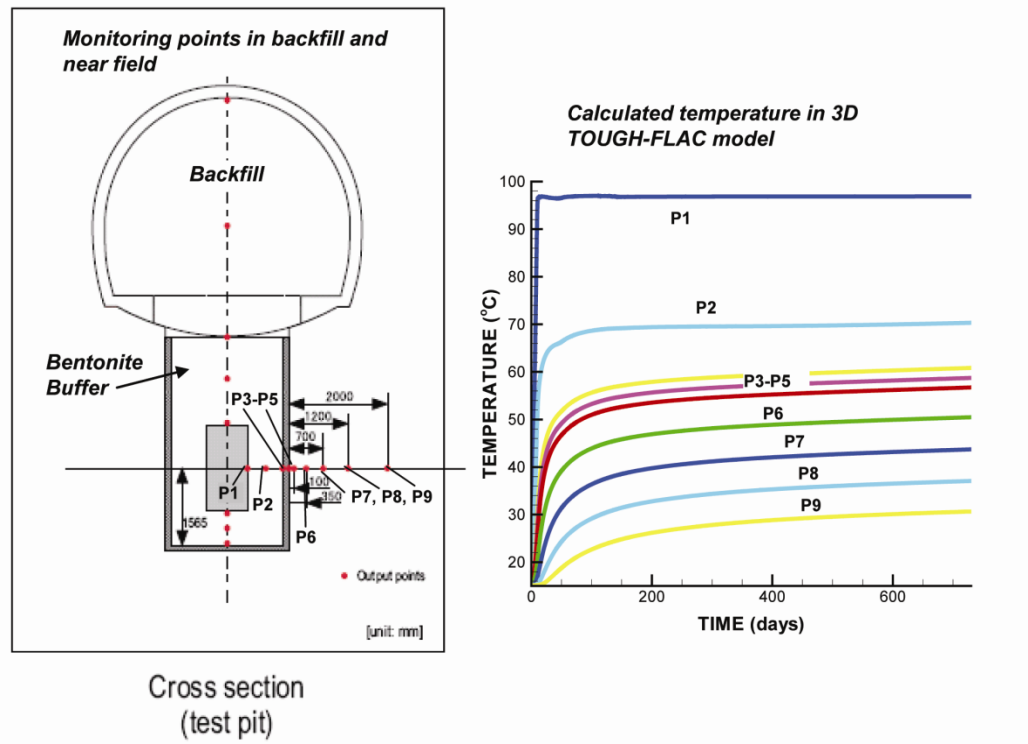

Figure 6.1-6 EBS Experiment: TOUGH-FLAC simulation results of temperature in the buffer and rock (from Zheng et al. 2015).

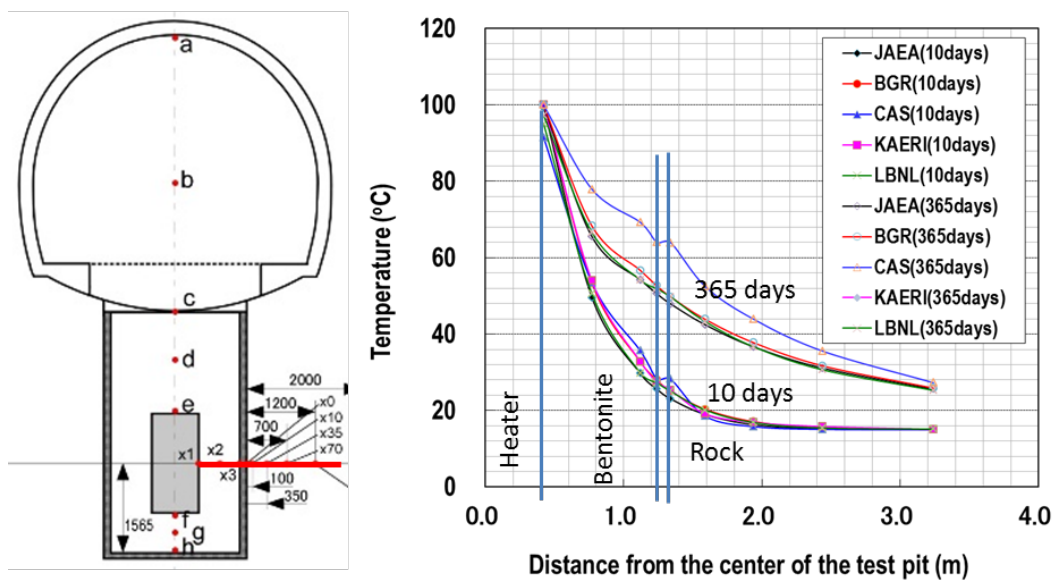

Figure 6.1-7 Comparison of simulated temperature profiles at 10 and 365 days among the DECOVALEX modeling teams (Zheng et al. 2015).

The LBNL team simulated the experiment in three steps:

The final step of Task B1 was to complete a calibration analysis using measured data provided by the JAEA. Figures 6.1-8 and 6.1-9 show a comparison of LBNL’s predictions with the measured changes of temperature and radial stress during the first 75 days of heating at six different locations. The temperature predictions are excellent, whereas stress predictions show some deviations. However, both the modeling predictions and measurements demonstrate that the stress changes in the buffer are quite small during the initial heating phase. On the other hand, the trends of the stress evolutions are quite different between the model predictions and measurements, likely because a simple linear relationship between the swelling strain and liquid saturation was applied. Such a model maybe used to predict the final swelling stress, but may not be accurate in prediction of the path of the swelling strain and stress along with changes in saturation.

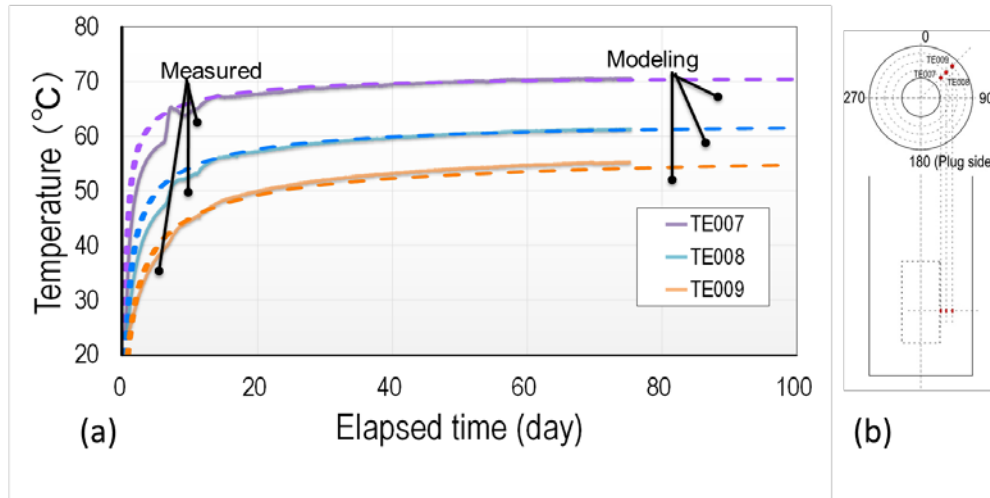

Figure 6.1-8 (a) Predicted and measured temperature evolution at three monitoring points in the buffer and (b) map view and vertical cross-section of the test pit monitoring points (Zheng et al. 2016).

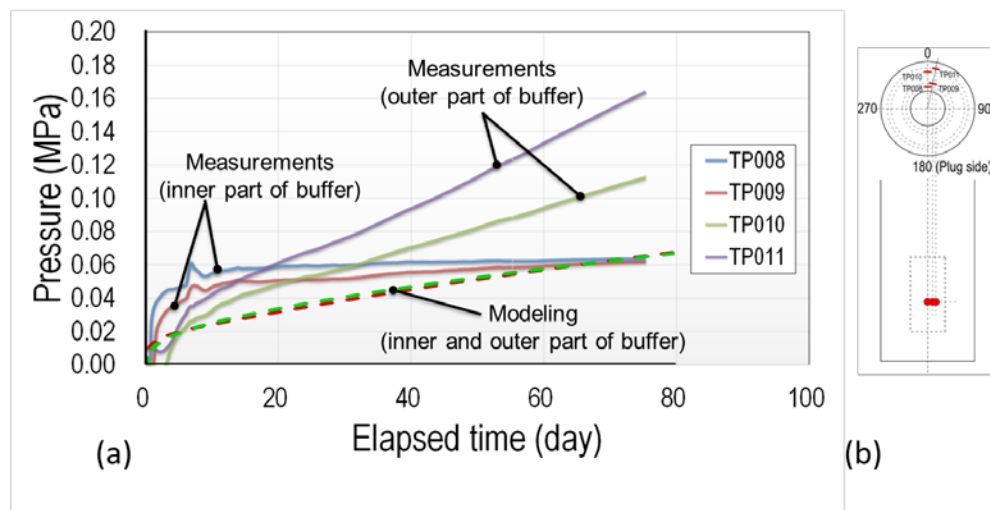

Figure 6.1-9 (a) Predicted and measured stress evolution at four monitoring points in the buffer, and (b) map view and vertical cross-section of the test pit with monitoring points (Zheng et al. 2016).

6.1.1.4 Modeling of FE Heater Test at Mont Terri

LBNL is one of seven international modeling teams conducting THM simulations for the design of the FE Heater Test and for the evaluation of monitoring data. As mentioned in Section 3.1.2, the heating phase of the experiment started in February 2015. FE is the largest and will be the longest-duration heater test worldwide, with focus on both the EBS components and the host-rock behavior. Over more than a decade, the experiment will provide data useful for the validation of THM coupling effects regarding the processes in the host rock, while correctly accounting for (and examining) the conditions in the emplacement tunnel (temperature, saturation, and swelling pressure). Due to the 1:1 scale of the experiment, it is possible to achieve realistic temperature, saturation, and stress gradients in the emplacement tunnel and the host rock, which is extremely useful for THM model validation.

In FY14 and FY15, international modeling teams including LBNL have conducted design predictions for the FE Heater Test, developing conceptual models and selecting material properties from the review of available literature (papers and reports) on lab experiments and previous Mont Terri *in situ* tests. Several sets of scoping simulations were conducted to probe the relevance of coupled processes, evaluate their significance and parameter range, compare conceptual models, test sensitivity to input parameters, and summarize lessons learned before the onset of the experiment (parameter ranges, importance, and expected response). This initial step was complemented with a restricted benchmark test for code comparison, in which properties and model geometry were defined by NAGRA. In FY16, modeling teams moved into a new modeling phase with evaluation, interpretation, and validation using the initial set of measured data from the FE Heater Test. Below, we briefly introduce LBNL's model setup for the FE Heater Test and then provide examples of the interpretation/validation modeling.

In collaboration with NAGRA and other teams, LBNL developed a sophisticated 3D TOUGH-FLAC model for the THM design predictions (Zheng et al. 2014). The host rock is modeled with anisotropic properties considering bedding planes in the Opalinus Clay. An inclined TOUGH-FLAC mesh was created to accurately represent anisotropic thermal and hydrological behavior. Anisotropic mechanical material behavior is simulated using the FLAC3D ubiquitous joint model, with initial properties derived from excavation design analysis conducted by another FE Heater Test modeling team (Nater 2012). In the ubiquitous joint model, weak planes are assumed along the bedding planes of the Opalinus Clay; in other words, the shear strength properties are different in the direction of bedding versus the direction across bedding. Bentonite behavior is accounted for with the Barcelona Basic Model (BBM). Initial model parameters for the bentonite and the rock are based on those developed for the HE-E Heater Test.

Figure 6.1-10 presents the 3D TOUGH-FLAC numerical grid of the FE experiment. This model grid includes all vital material components for the modeling of the FE experiment, including layered Opalinus Clay host rock, excavation-disturbed zone, tunnel, three heaters, bentonite buffer, concrete liner, and concrete plug. As in the real test, the simulations start with an open tunnel at atmospheric pressure for one year, creating a pressure drop and hydraulic gradient around the tunnel. Thereafter, the model assumes instantaneous emplacement of the heater and buffer, and the heating period is simulated. Figures 6.1-11 compares the simulated evolution of temperature in comparison with the measured data from the first 400 days of heating. Good agreement can be seen between model and measurements. The temperature at the heater surface is substantially lower below the heater (adjacent to bentonite blocks, around 118°C after 400 days) than at the side of the heater (adjacent to granular bentonite, around 125°C after 400 days). This difference can be explained by the fact that the thermal conductivity of the compacted bentonite blocks is much higher than that of the granular bentonite at the initial saturation. Figure 6.1-12 shows a reasonable agreement between modeled and measured relative humidity, which was achieved by using the porous medium tortuosity factor of 0.14. No other material parameters for bentonite or Opalinus Clay were modified compared to those of the HE-E experiment.

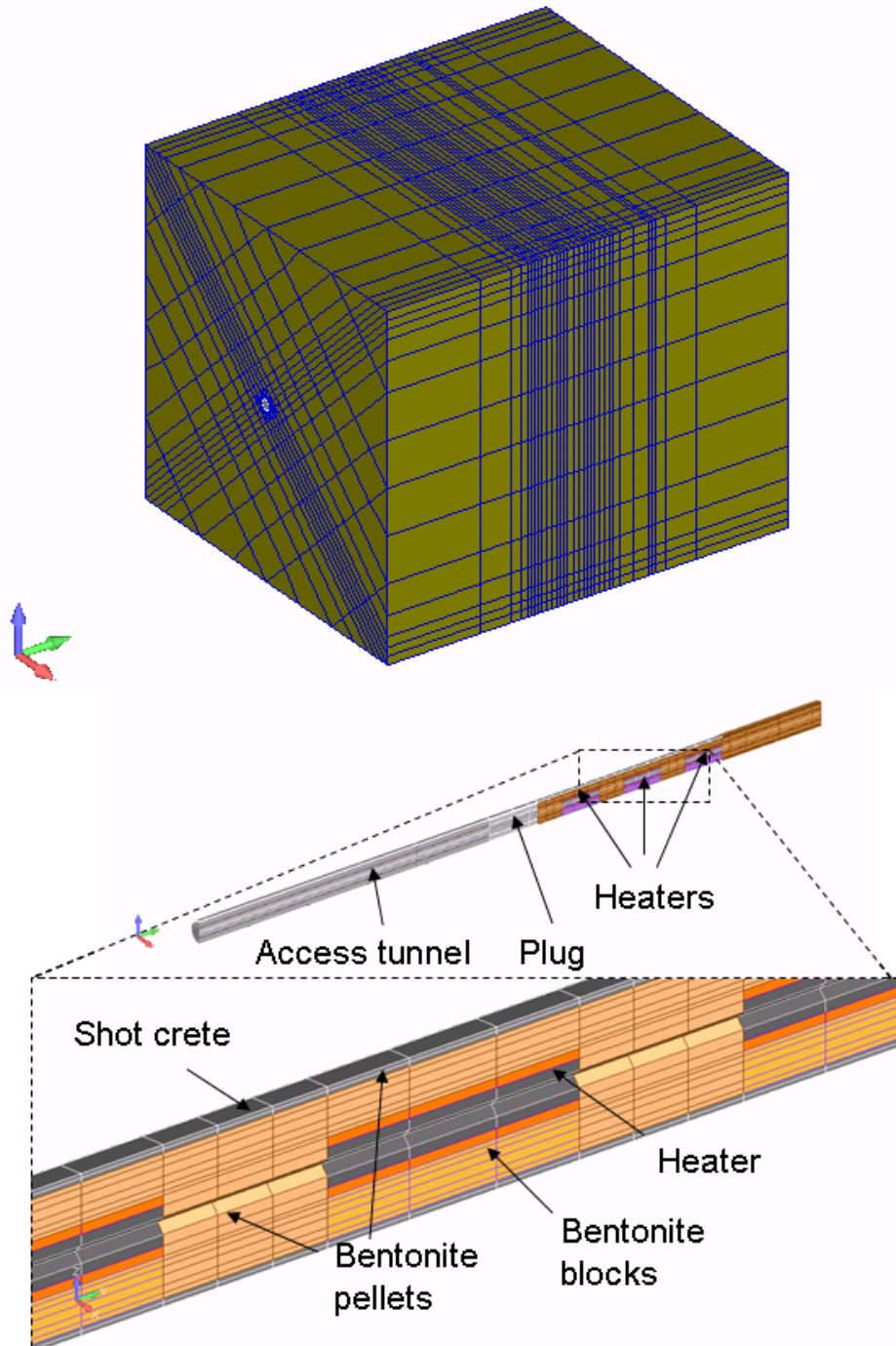
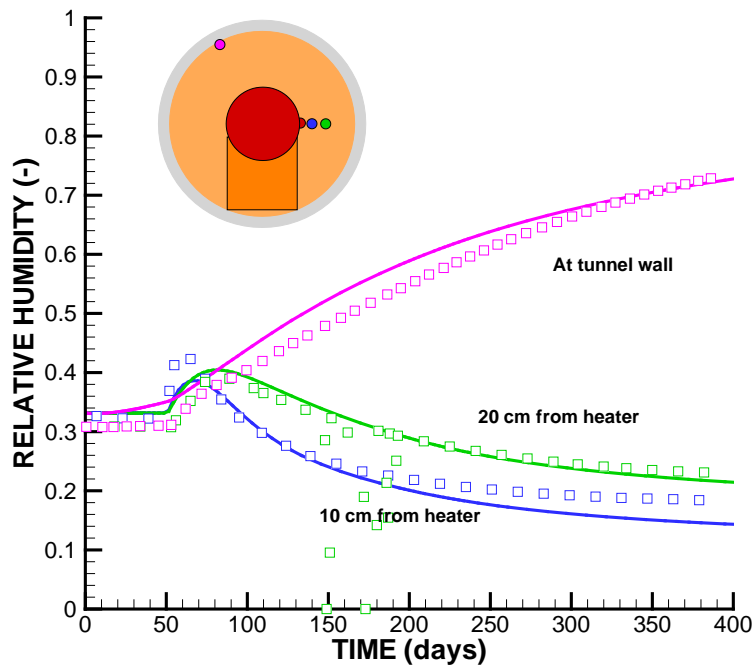
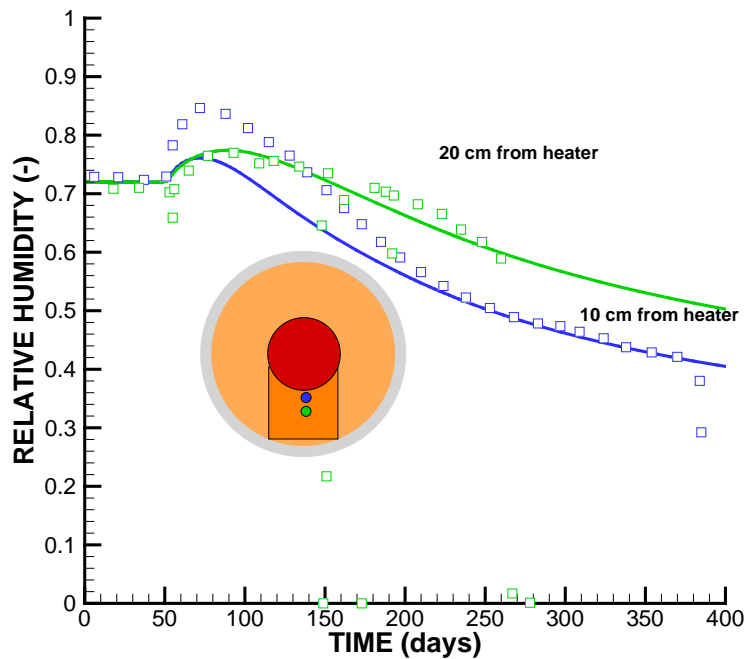

Figure 6.1-10 TOUGH-FLAC 3D numerical grid of the FE experiment (Zheng et al. 2016).



(a)



(b)

Figure 6.1-11 Comparison of modeled (lines) and measured (symbols) evolutions of relative humidity at monitoring points located in (a) granular bentonite and (b) bentonite blocks (Zheng et al. 2016).

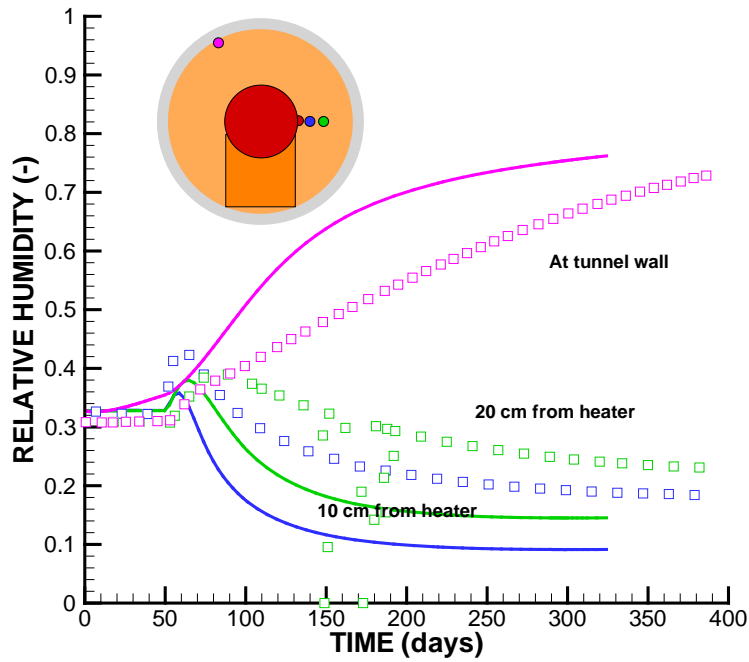

(a)

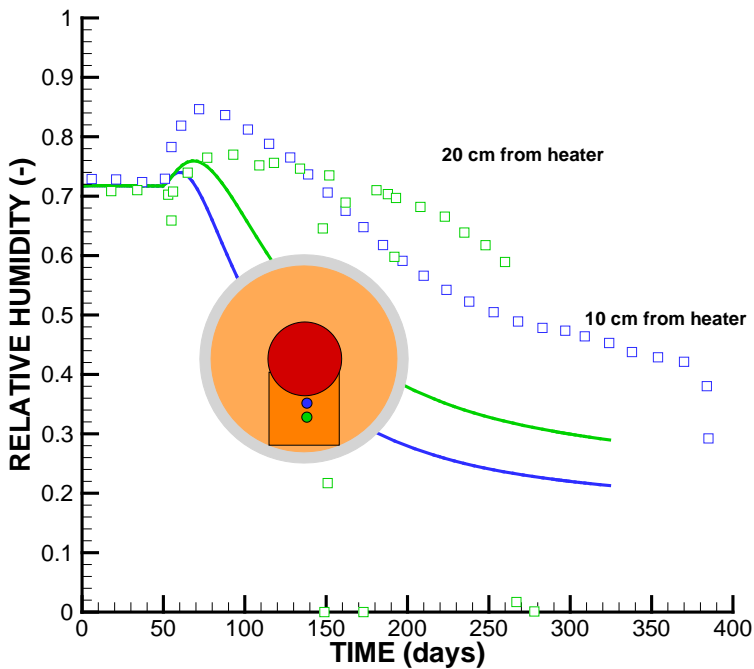

(b)

Figure 6.1-12 Comparison of modeled (lines) and measured (symbols) evolutions of relative humidity at monitoring points located in (a) granular bentonite and (b) bentonite blocks for a diffusion tortuosity factor of 0.14 (Zheng et al. 2016).

6.1.1.5 Summary of Modeling Heater Tests in Argillite Rocks

Over the past few years, UFD researchers have greatly benefited from participating in international activities for developing expertise and testing advanced models for coupled THM processes. As described below, LBNL scientists have been utilizing data and results from laboratory and field studies, which have been and are being conducted with millions of R&D investments provided by international partners. UFD simulators are being verified and validated against these experimental studies, providing a robust modeling and experimental basis for the prediction of the complex long-term THM and THMC evolution of a multi-barrier waste repository system involving backfilled emplacement tunnels and argillite host formations. Specific FY2016 accomplishments of UFD scientists include:

- Modeling of large-scale *in situ* heater experiments involved both bentonite and rock perturbations measured in the Mont Terri HE-E, Horonobe EBS, and Mont Terri FE experiments. Modeling these experiments required large 3D models, involving the interaction of all relevant components, such as simulated waste package, bentonite buffer, and host rock. Modeling a full-scale real system is the ultimate goal of the numerical modeling, which provides a valuable experience in preparation for the performance assessment of future high-level nuclear waste disposal sites in the U.S.
- The DECOVALEX-2015 modeling tasks associated with the Mont Terri HE-E experiment and Horonobe EBS experiment were successfully completed. Using these experiments, the improvement and efficiency of the Barcelona Expansive Model (BExM) in TOUGH-FLAC could be successfully demonstrated.
- For the first time, the analysis of field data from the Mont Terri FE experiment, the largest ongoing underground heater test in the world, was used for model validation.
- The interpretative analyses of heater experiments and an evaluation of the results of predictive modeling confirmed that temperature and moisture evolution can be predicted with confidence.
- More work is needed to analyze and validate predictions of the complex mechanical evolution of the buffer, which depends on a number of processes such as moisture swelling, pore pressure and thermal expansion that are in turn dependent on the evolution of saturation, temperature, pressure and 3D geometrical mechanical confinement effects. In the Mont Terri FE Heater Test, stress changes are comprehensively monitored to assess the mechanical changes in both buffer and host rock; however, it will take a few more years for stress increases to develop.

6.1.2 Modeling and Experimental Studies Related to the FEBEX-DP Project

As described in Section 3.3.2, the FEBEX-DP project provides a unique opportunity to evaluating the long-term behavior of an engineered barrier that underwent continuous heating with natural resaturation for about 18 years. LBNL/DOE joined the FEBEX-DP project with its initiation in FY15. In FY15, LBNL scientists participated in the pre-dismantling modeling, with particular focus on the chemical alteration of the bentonite and how this alteration is affected by THM processes, such as hydration, thermal osmosis, and swelling (Zheng et al. 2015). In FY16, as data from the dismantling and sampling campaign became available, UFD scientists engaged in two main activities: (1) Post-dismantling THMC modeling was conducted to interpret various measurements available from analyzing the dismantled samples (Zheng et al. 2016), and (2) Laboratory experiments were conducted on FEBEX samples with focus on the micro-structure of the bentonite and shotcrete samples, and respective interfaces, after being exposed to 18 years of heating (Zheng et al. 2016; Jove-Colon 2016).

6.1.2.1 Post-dismantling Modeling of the FEBEX-DP Data

In FY16, the LBNL team carried out the research aimed at the development of coupled THMC models needed to predict the hydrological, mechanical and chemical evolution of bentonite as it hydrates, swells and is exposed to heat. The ultimate goal of LBNL's modeling effort is to develop an advanced coupled THMC model of the FEBEX-DP behavior tested against observation data. Specifically, the following questions are to be answered with THMC modeling:

- What causes the hydration of bentonite to be slower than typically predicted by a Darcy flow model: Non-Darcian flow behavior, thermal osmosis that counteracts flow toward the heater, decrease of intrinsic permeability of the buffer due to changes in microstructure, or a combination of all these processes?
- What is the spatial density variation of the bentonite as a result of long-term hydration and swelling?
- What is the chemical evolution in the bentonite, especially the changes of more soluble minerals (gypsum, calcite and pyrite) and aqueous concentration, evolution of pH and Eh and alteration of smectite or other clay minerals?

Once the coupled THMC model can simultaneously match the measured temperature, relative humidity, water content, stress, aqueous concentrations, and minerals phase changes observed in the FEBEX-DP, it can be considered validated and can further be used, for example, to predict the long term evolution of engineered-natural barrier systems (e.g. one hundred thousand years as required by most performance assessment) under different conditions, such as when exposing bentonite to higher temperatures to accommodate waste packages with higher heat output.

As described in Zheng et al. (2015; 2016), LBNL's THMC simulations for the FEBEX-DP were conducted with TOUGHREACT-FLAC3D, which sequentially couples the multiphase fluid flow and reactive transport simulator, TOUGHREACT (Xu et al. 2011), with the finite-difference geomechanical code FLAC3D (Itasca 2009). The coupling of TOUGHREACT and FLAC was initially developed in Zheng et al. (2012) to provide the necessary numerical framework for modeling fully coupled THMC processes. It was equipped with a linear elastic swelling model (Zheng et al. 2012; Rutqvist et al. 2013) to account for swelling as a result of changes in saturation and pore-water composition and the abundance of swelling clay (Liu et al. 2013; Zheng et al. 2014). Recent additions to the code include the capability of simulating Non-Darcian flow (Zheng et al. 2015) as well as two mechanical models for bentonite swelling—a linear swelling model and the more complex dual structure Barcelona expansive clay model (BExM) (Zheng et al. 2016). The linear swelling model can easily be calibrated, but it does not describe correctly the transient of state of swelling. The BExM (Alonso et al. 1999; Sánchez et al. 2005) provides a better mechanistic description of the bentonite behavior, and was ultimately used to simulate the mechanical behavior of the FEBEX *in situ* test. Modeling the chemical evolution of the FEBEX test requires first the knowledge of initial chemical conditions in bentonite and granite, i.e., the initial mineralogical and pore water compositions. Zheng et al. (2016) used the average of mass fractions reported in ENRESA (2000), Fernández et al. (2004) and Ramírez et al. (2002). Previous THMC models for the *in situ* test (Samper et al. 2008; Zheng et al. 2011) only included quartz in the minerals assemblage in the granite host rock. In LBNL's FY16 model, Zheng et al. (2016) considered quartz, K-feldspar, plagioclase in granite. Detailed descriptions of the pore water composition for granite and bentonite are given in Zheng et al. (2016). In terms of chemical reactions, the model considered aqueous complexation, cation exchange, surface complexation and mineral dissolution/precipitation.

Below, we present some example results from the FY16 modeling effort. In the FEBEX *in situ* test, certain data were collected real time by sensors buried in the bentonite block and the near-field granite, such as temperature, relative humidity and stress; and some data were measured in the laboratory using the bentonite sample that were taken after dismantling of test sections, including water content, dry density, concentration of ions in pore water and mineralogical composition. The dismantling of Heater #1 in 2002 and that of Heater #2 in 2015 provide two snapshots with detailed spatial account of measured water content, dry density, and concentrations of ions in pore water and mineralogical composition, which are very valuable for understanding the temporal evolution of these key data, as shown later in the report. Note that concentrations of ions in pore water and mineralogical composition have been analyzed by the other partner of FEBEX-DP project and are not available yet.

Figures 6.1-13 compares the measured temperatures evolution at a selected sensor against simulation results for two alternative model concepts, a simple TH model (TH) and a complex THMC model with linear swelling (THMC-LS). Starting February 27, 1997, a constant power of 1200 W was applied to each heater for 20 days, and then a constant power of 2000 W for another 33 days, followed by a constant temperature mode, allowing the heater power to fluctuate freely, but the maximum temperature at the surface of steel liner of the heater was maintained at 100°C. Generally, the results of both models match well with the temperature data at radial distances. After the shutdown of heater #1 on February 2, 2002, the temperature field changed, as manifested by the temperature evolution after 1827 days.

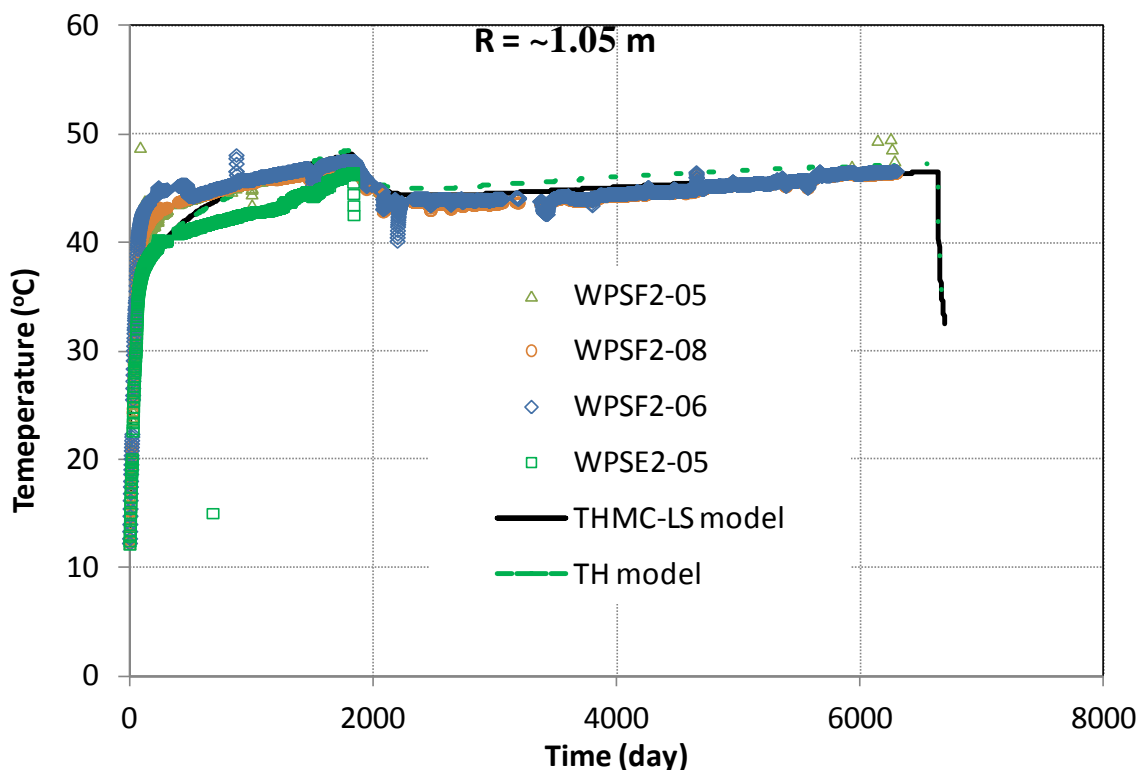

Figure 6.1-13 Measured temperature by sensor located at radial distance 1.05 m in sections E2 and F2 and model results from the TH model and THMC model with linear swelling (THMC-LS) (Zheng et al. 2016).

Next we compare model predictions and data for spatial distributions of bentonite properties, as are now available at two distinct times: after the dismantling of Heater #1 (in 2002, 5.3 years after the start of

heating) and after the dismantling of Heater #2 (in 2015, 18.3 years after the start of heating). Figure 6.1-14 shows the measured water content as a function of distance from the heaters, in different dismantling cross-section, and compares these to the model results. It is evident that the bentonite near the heater remained fairly dry, with water content close to the initial value, whereas the bentonite near the granite host rock became fully saturated, with gravimetric water content ranging from 25% to 35% (Figure 6.1-14). Again, two different models are tested, a simple TH model and a complex THMC model. The TH model with a constant porosity fails to match the measured data at both times—the model underestimates the water content near the granite and overestimates the data in the middle of bentonite barrier. In contrast, the THMC model that accounts for the swelling of bentonite and subsequent porosity and permeability changes clearly outperforms the TH model and matches reasonably well the data at 5.3 and at 18.3 years.

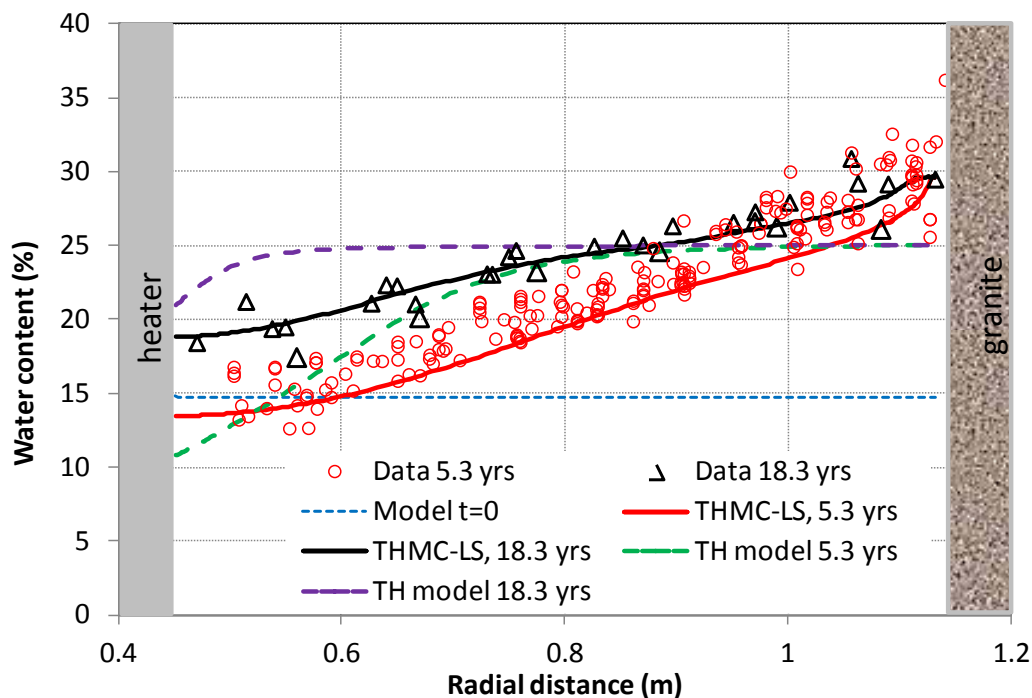

Figure 6.1-14 Measured water content data at cross sections 19, 28 and 29 and cross sections 22 and 27 (Daucousse and Lloret 2003) after the dismantling of heater #1 (“data 5.3 yrs.”) and at cross section 49 after the dismantling of heater #2 (“data 18.3 yrs.”) and model results from the TH model (TH), and the THMC model with linear swelling (THMC-LS) (Zheng et al. 2016).

The two dismantling events in the FEBEX *in situ* test also provide a unique opportunity to check the both the spatial and temporal evolution of the geochemistry in bentonite, a valuable data set that is otherwise impossible to obtain. Because the geochemical analytical results will not be available until the end of 2016, LBNL’s FY16 work utilized the chemical data obtained after the dismantling of Heater #1. In FY16, great efforts were dedicated to develop and calibrate the coupled THMC models against these chemical data. However, as shown in Figure 6.1-15, there are some remaining discrepancies between the model results and the measured data, which will be very useful in further constraining the THMC conceptual models and model properties. For example, the model generally overestimates the concentrations (e.g., Calcium in Figure 6.1-15) near the granite interface and underestimates concentrations near the heater. The decrease in permeability at the outer rings of the bentonite barrier in

the THMC model leads to less water infiltration and thus less dilution, which is why the THMC model has higher chloride concentration near the granite than the THC model. Less water infiltration also means less evaporation near the heater, which explains why the THMC model has lower chloride concentration near the heater than the THC model. Zheng et al. (2016) showed that an application of a correct permeability-porosity relationship or considering a process of thermal osmosis might allow the THMC model to match both the THM and chemical data. Chemical reactions alter concentration levels but not the overall trend of the concentration profiles. Similarly, just as the THMC model overestimates the concentration of calcium near the bentonite/granite interface, it also overestimates the concentrations of chloride, sodium, calcium, magnesium, and potassium as well. A detailed comparison of the modeling results with measured concentrations is given in Zheng et al. (2016).

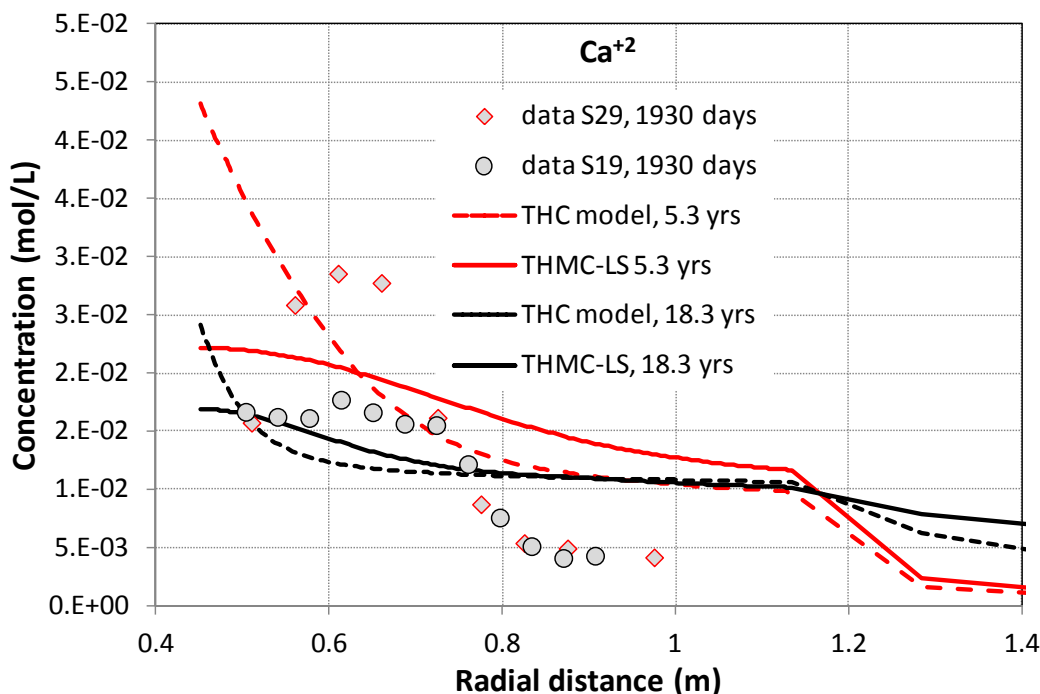

Figure 6.1-15 The measured concentration profile of calcium at 5.3 years and model results from a THC model versus a THMC model with linear swelling (THMC-LS) (Zheng et al. 2016).

Thus, the key findings from the modeling results are as follows:

- As expected, the THMC model outperformed the THC model in terms of matching measured THM data. Permeability and porosity changes due to mechanical process (swelling) were the key to matching all the THM data.
- Although the THMC models successfully matched the THM data, they failed to desirably match the measured concentration profile of conservative species (chloride) at 5.3 years and subsequently the concentration profile of reactive species. The concentration profiles of cations (calcium, potassium, magnesium and sodium) were largely shaped by transport processes despite that their concentration levels were affected by mineral dissolution/precipitation and cation exchange. The concentration profile of pH, bicarbonate and sulphate were largely determined by chemical reactions.
- Revising the function for permeability changes in the THMC model improved the goodness-of-fit to chloride concentration profile but deteriorated the fit to water content data. It seemed there was

a dilemma that the THMC model cannot match both the THM and chemical data simultaneously, suggesting that additional processes might be needed in the conceptual model.

- The THMC model predicted that concentration levels of major cations and anions at 18.3 years when the heater #2 was dismantled would continue going down in most parts of the bentonite barrier except the area very close to the heater, where the concentration would go up, which will be compared with concentration data that are expected to be available by the end of 2016.

6.1.2.2 *Microstructural Analysis of the FEBEX-DP Data*

In FY16, UFD scientists conducted microstructural analysis of samples shipped from the FEBEX-DP project to evaluate the potential for long-term chemico-mechanical alterations in heated engineered barrier materials. LBNL scientists conducted a series of synchrotron X-ray microCT (SXR- μ CT) examinations of micro-fractures in the bentonite samples; fracture networks for various samples were obtained and quantified (Zheng et al. 2016). Additional microscopic characterizations were carried out by SNL using SEMBSEI/EDS and micro-XRF to analyze FEBEX-DP bentonite-shotcrete overcore samples, which revealed that much of the reaction in this region appears to be confined to the shotcrete phase and little or no chemical alteration is experienced in the bentonite (Jove-Colon 2016). Below we provide short illustrations of the sample analysis results from both studies.

LBNL utilized the 8.3.2 beamline of the Advanced Light Source facility to conduct synchrotron X-ray microCT (SXR- μ CT) experiments on bentonite samples after 18.3 years of heating (Zheng et al. 2016). SXR- μ CT has so far proven to be a very valuable tool for studying the fracture network of these samples. While some sample conservation and preparation issues might be present in this method, the basically non-destructive aspect of the technique puts SXR- μ CT at an advantage to other imaging methods such as scanning electron microscopy (SEM), where dehydration cannot be avoided and could lead to desiccation of bentonite and the creation of micro-fractures. Figure 6.1-16 shows typical results from an experiment conducted at the ALS, showing the initial micro-CT scan results (at the top) and the digital representation of the bentonite micro-fractures at the bottom. From the results, one can appreciate that the samples are pervaded by a network of thin fractures, with sizes in the order of the few tens of microns. In the volume renderings one can see that the fractures are present in the clay matrix, some cut across larger crystalline particles (quartz, feldspar, etc.), and some fractures are located along the interfaces of the crystals with the clay-rich matrix. From this observation it seems safe to assume that there are different mechanisms involved in the development of the fractures. Figure 6.1-17 shows results obtained at a higher resolution (of a few hundred nanometer), the objective being to evaluate the possible presence of smaller features, below the resolution of the measurements in Figure 6.1-16, are missed using the lower resolution scans (which were done at a few micrometer), and to check if those are important.

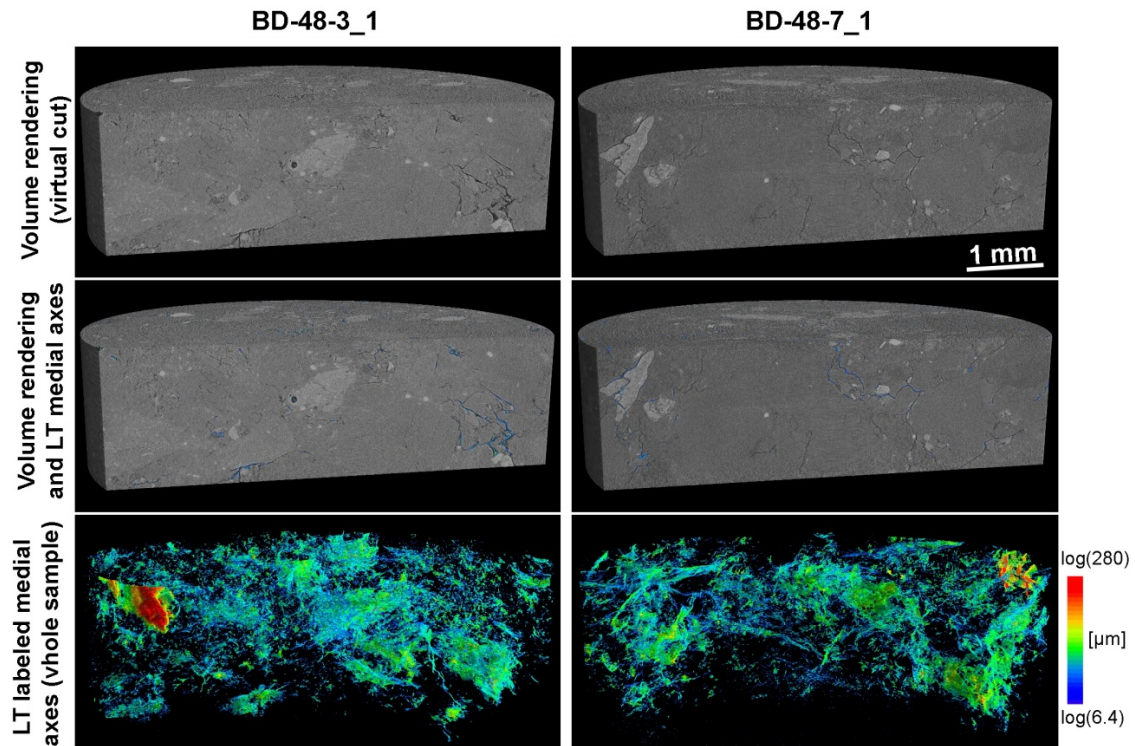

Figure 6.1-16 Graphical results of the micro CT analysis of two samples from section 48: BD-48-3 (near the heater) and BD-48-7 (near the granite) (Zheng et al. 2016).

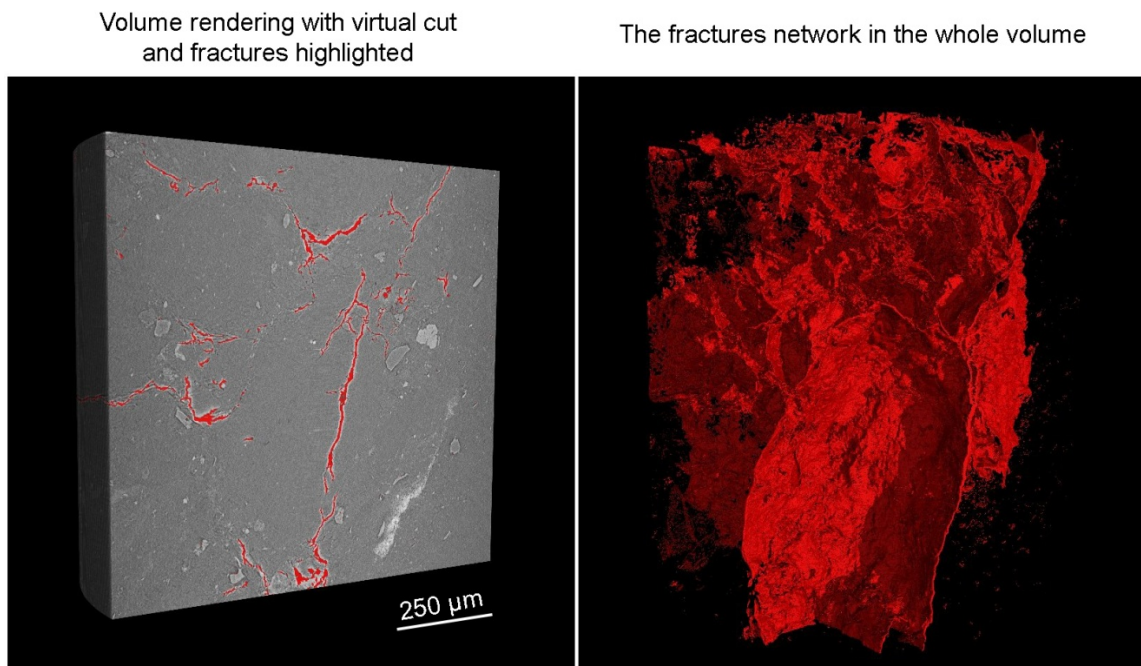

Figure 6.1-17 Results from the high-resolution SXR- μ CT measurement on sample BD-48-7. The voids have been highlighted in red (Zheng et al. 2016).

Complementing LBNL’s work in FY16, SNL scientists conducted characterization using X-ray CT (micro computerized tomography) imaging, SEM/EDS analyses, and micro-X-ray fluorescence (XRF) of samples obtained from FEBEX-DP phase of heater #2 which include: 1) overcore sample from the shotcrete plug – bentonite interface, and samples from sections 49 and 58 corresponding to bentonite domains near and far from the heater zone, respectively (Jove-Colon 2016). SEM/EDS analyses were conducted in both shotcrete – bentonite overcore thin sections and granular samples from section 49 whereas the X-ray CT image analysis was only performed on epoxied overcore samples. The main objective of this characterization study was to (1) identify spatial heterogeneities of barrier materials near and far from EBS interfaces that can inform process models (e.g., porous media transport), and (2) analyze the extent of chemical variations and heterogeneities (e.g., reaction fronts) at EBS interfaces and bulk barrier materials. Figure 6.1-18 shows example results from X-Ray CT scans of the of the shotcrete-bentonite interface region. The salient features from the analysis of 2D slices are the common occurrences of microcracks in bentonite and pores (no cracks) in shotcrete. Formation of gaping cracks and pores in bentonite tends to form near or at the shotcrete-bentonite interface whereas in other cases these are found at the interface of dissimilar materials (bentonite-epoxy). Crack formation is not only restricted to areas close to material interfaces but are also common to bulk bentonite regions as well (consistent with LBNL’s findings). Compositional analysis using micro – X-ray Fluorescence (XRF) were also conducted to evaluate chemical alterations. Figure 6.1-19 shows example results from micro-XRF maps for Ca and S indicating slight or virtually no alteration on the bentonite side. The Ca and S compositional maps also suggest the existence of an apparent millimeter-scale depletion zone in the shotcrete close to the interface. The depletion zone is demarcated by some gradation from the bulk shotcrete towards the bentonite interface that is depicted by the Ca map.

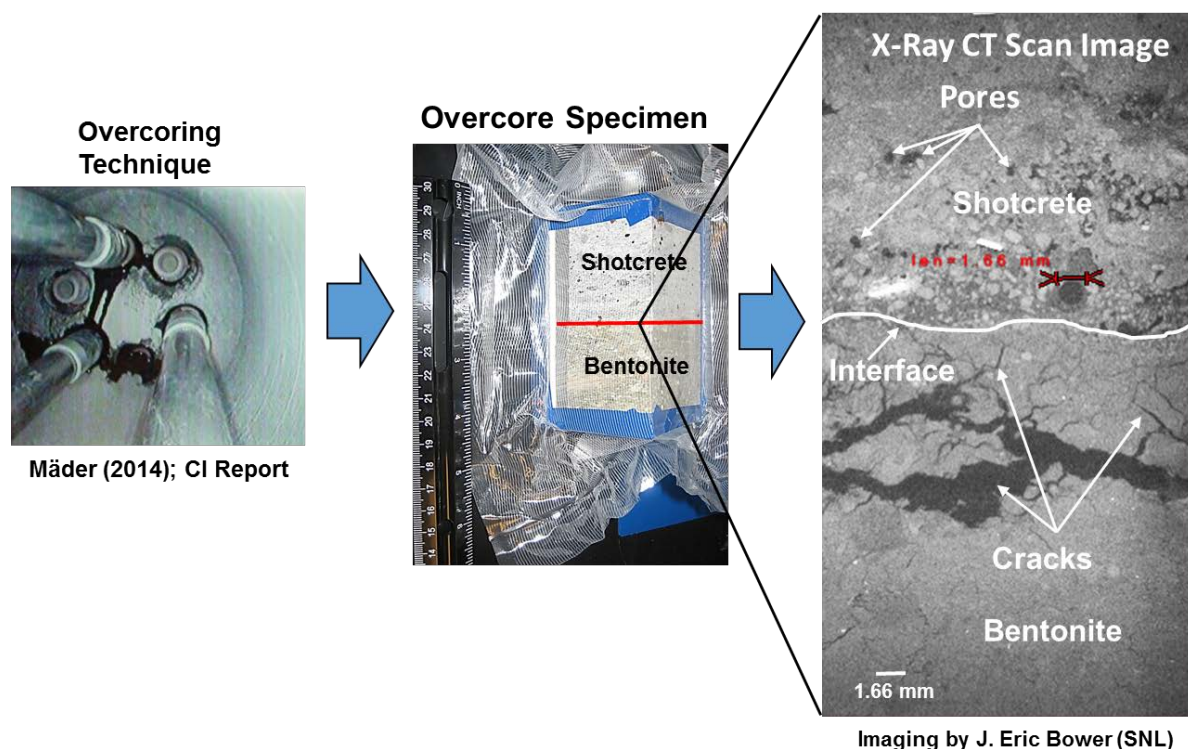

Figure 6.1-18 Photographs of the overcoring method (left), shotcrete-bentonite overcore sample (center) and the X-ray CT image (right) focusing on the interface region (Jove-Colon 2016).

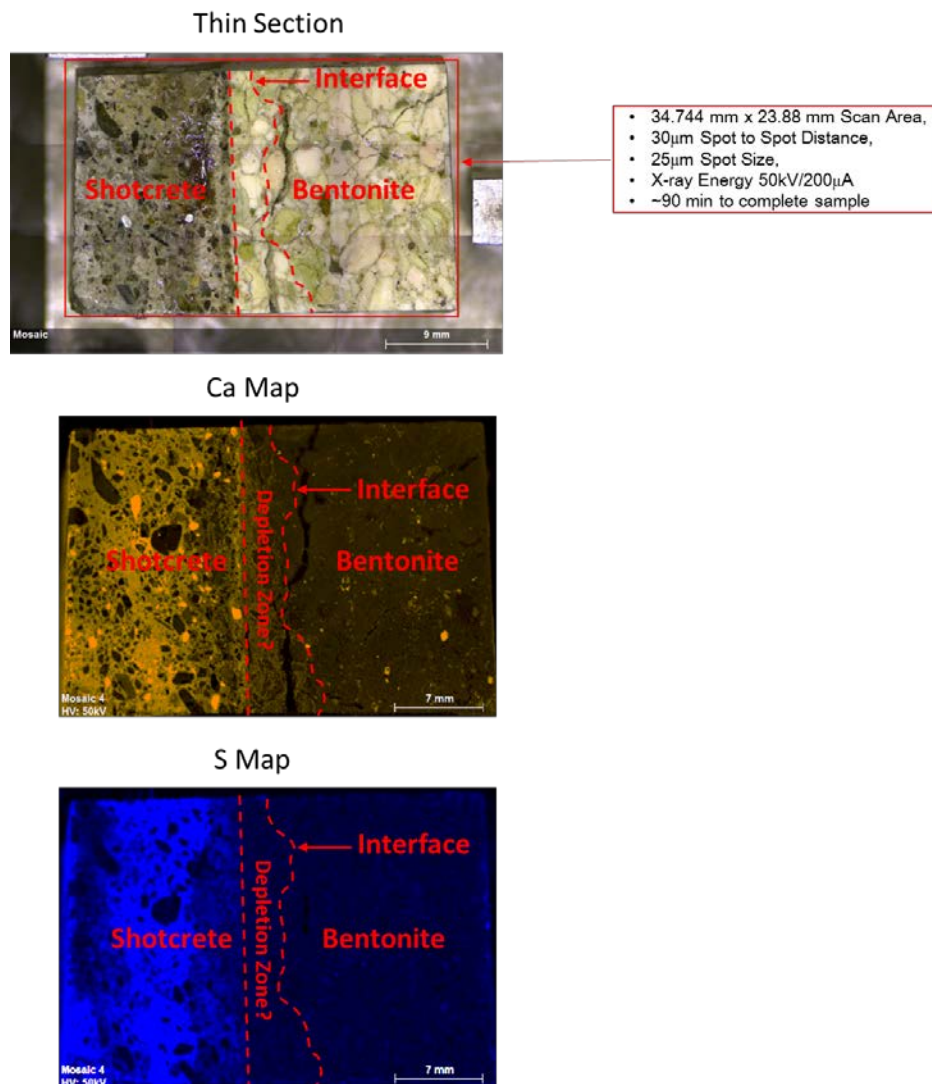

Figure 6.1-19 Micro-XRF maps for Ca and S at the shotcrete-bentonite interface. An apparent depletion zone close to the shotcrete-bentonite interface is delineated by red-dashed lines.

In summary, the micro-structural and chemical alterations of engineered barrier materials have been imaged by UFD scientists using advanced micro-characterization techniques. X-Ray CT and micro-CT techniques are powerful characterization tools in the analysis of nano-micron-to-millimeter scale structures in bentonite and shotcrete. This technique allows for the 2D-3D characterization of microcracks in FEBEX-DP bentonite and shotcrete-bentonite samples highlighting the importance of desiccation/shrinkage processes in bentonite and the nature of pores/voids in shotcrete. SEMBSEI/EDS and micro-XRF characterization of FEBEX-DP shotcrete-bentonite samples revealed that much of the reaction in this region appears to be confined to the shotcrete phase and little or no alteration was experienced by bentonite. This has implications to processes such as pore clogging and secondary mineralization at interfaces considered in reactive-transport models to assess barrier performance for interactions with cement.

6.1.3 Discrete Fracture Network (DFN) Modeling of the HG-A Experiment at Mont Terri

To more accurately characterize and model excavation-damage-zone evolution and its impact on flow and transport, LBNL has developed a new modeling approach for studying hydro-mechanical coupled processes, including fracture development, within geologic formations. This is accomplished through the novel linking of two codes: TOUGH for subsurface multiphase flow based on the finite volume method, and RBSN (Rigid-Body-Spring-Network) for discrete (lattice) representation of material elasticity and dynamic fracture development/propagation. The RBSN formulation is based on the concept of the Rigid-Body-Spring model, first introduced by Kawai (1978), in which the material constitution is represented as a collection of rigid bodies connected by spring sets. TOUGH is used to simulate relevant scalar quantities (e.g., temperature, pressure, and degree of saturation) associated with fluid flow and heat transport, whereas RBSN accounts for mechanical quantities (e.g., displacement, strain, and stress) of interest. The TOUGH-RBSN simulator predicts fracture evolution, as well as mass transport through fractured porous rock, under dynamically changing thermal-hydrologic and -mechanical conditions. The modeling approach is facilitated by a Voronoi-based discretization technique common to both codes, capable of representing discrete fracture networks embedded in a porous matrix. Further details on this method and UFD-related applications are provided in Section 3 of Zheng et al. (2014). More recent developments of the TOUGH-RBSN simulator, including a new dynamic simulation framework for RBSN that can be easily parallelized, are described in Zheng et al. (2015; 2016). This work on fluid driven fracture propagation forms the groundwork for another future application (DECOVALEX-2019 Task A, see Section 3.2.3.1), which is related to gas migration in bentonite and clay rocks as can be expected from long-term corrosion of canisters and hydrogen generation.

In FY13 and FY14, LBNL started testing the new TOUGH-RBSN modeling capabilities using data from the ongoing HG-A experiment at Mont Terri (Section 3.1). This experiment examines gas paths through the near-field host rock affected by the evolution of the damage zone. Several hydraulic and gas injection tests have been conducted, and a detailed discrete fracture mapping study was performed. The test is therefore a valuable testbed for discrete fracture and THM modeling capabilities. However, application to the HG-A experiment required a modification to the standard RBSN approach to account for anisotropic elastic properties of the RBSN spring sets. In the standard RBSN, the spring sets are oriented randomly as defined by the Voronoi element structure. In the new scheme, by comparison, all the spring sets are aligned with the principal bedding direction. The spring coefficients are defined in global fabric coordinates, where two orthogonal axes are normal and parallel to bedding, respectively. The anisotropic modeling scheme was validated through comparison with uniaxial compression tests for transversely isotropic rock specimens from Mont Terri. Cylindrical core samples were subjected to unconfined uniaxial compression, in which the loading direction formed an angle relative to the bedding plane.

An initial set of TOUGH-RBSN simulations for the HG-A experiment focused on the excavation damage observed in the micro-tunnel (Figure 6.1-20). The partial damage and exfoliations observed along the tunnel have been mainly attributed to the anisotropic strength characteristics of the rock. The relative weakness of the rock orthogonal to the bedding and the weakness near faults intercepting the tunnel resulted in the nonuniform damage around the excavation wall. Damage zones are more prominent at the tunneling wall tangential to the bedding planes. For identification of failure modes, individual fracture segments are drawn in different colors in Figure 6.1-20(b): blue and red segments represent tensile and shear failure modes, respectively. Tensile fracturing is concentrated at the borehole boundary, due to the lack of constraints against the pore pressure acting towards the center of the tunnel. This failure feature can be supported by observation of the deformation around the borehole. Figure 6.1-21 depicts the deformed shape of the tunnel, in which the deformation is exaggerated for better visibility. As one can

easily observe, the predicted fracture patterns show some distinct differences with the observed damage around the tunnel.

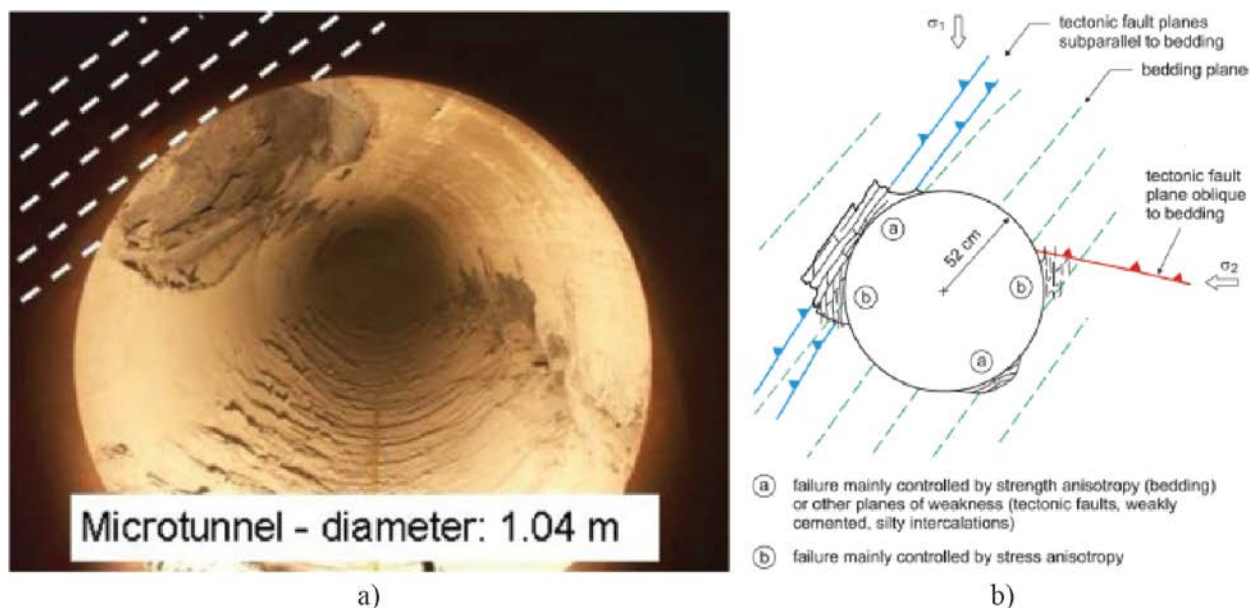

Figure 6.1-20 a) Excavation damage viewing from the HG-A Niche toward back end (Marschall et al. 2006); and b) Conceptual diagram of the damage zone (Lanyon et al. 2009).

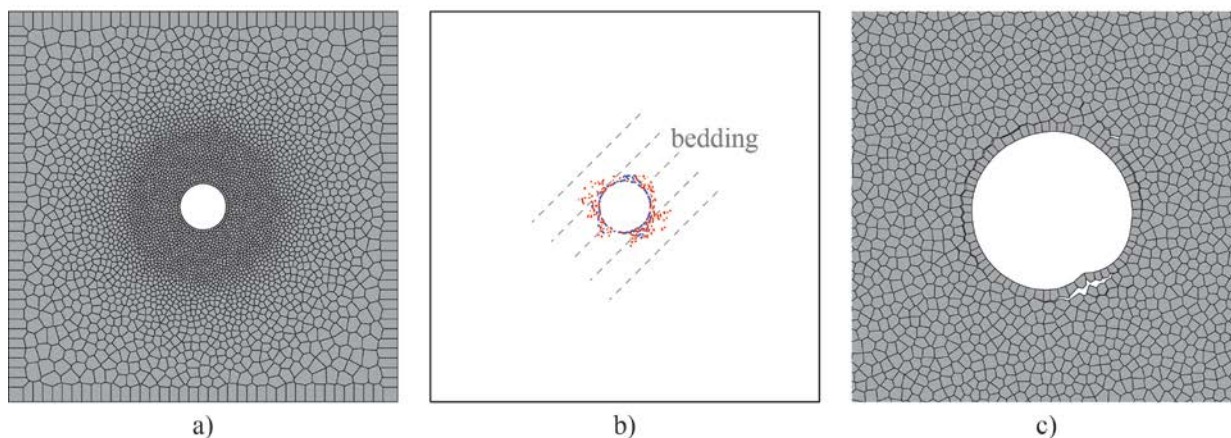

Figure 6.1-21 a) Discretization of the computational domain for the HG-A test simulation; b) nonuniform fracture pattern around the tunnel; and c) deformed shape of the borehole (Zheng et al. 2014).

In FY16, work on the HG-A tunnel damage analysis continued. The earlier TOUGH-RBSN model was improved by adding the effects of the faults on the failure characteristics. As shown in Figure 6.1-22, the initial 2D computational domain was finer discretized, and the fault planes observed in the field were precisely represented into the grid (see Figure 6.1-22), for which the weaker strength parameters were assigned. Figure 6.1-23 presents the simulated failure patterns, showing that the damage occurs mainly around the excavation zone, and more damage is found at the tunnel wall where its tangent is sub-parallel

to the bedding planes. This is consistent with the field observations (Figure 6.1-20). The effects of fault planes on the failure patterns can be interpreted by comparison between Figures 6.1-23 (a) and (b). The matrix domain is homogenous in the material composition, thus the failure pattern is quite symmetric without fault planes (Figure 6.1-23 a), which may be attributed to the anisotropic strength properties. However, in the presence of faults (Figure 6.1-23 b), distinct shear fractures develop along the fault planes, and then fractures grow from those fault planes. The resulting fracture pattern is not symmetric due to the stress contour perturbed by the fault planes.

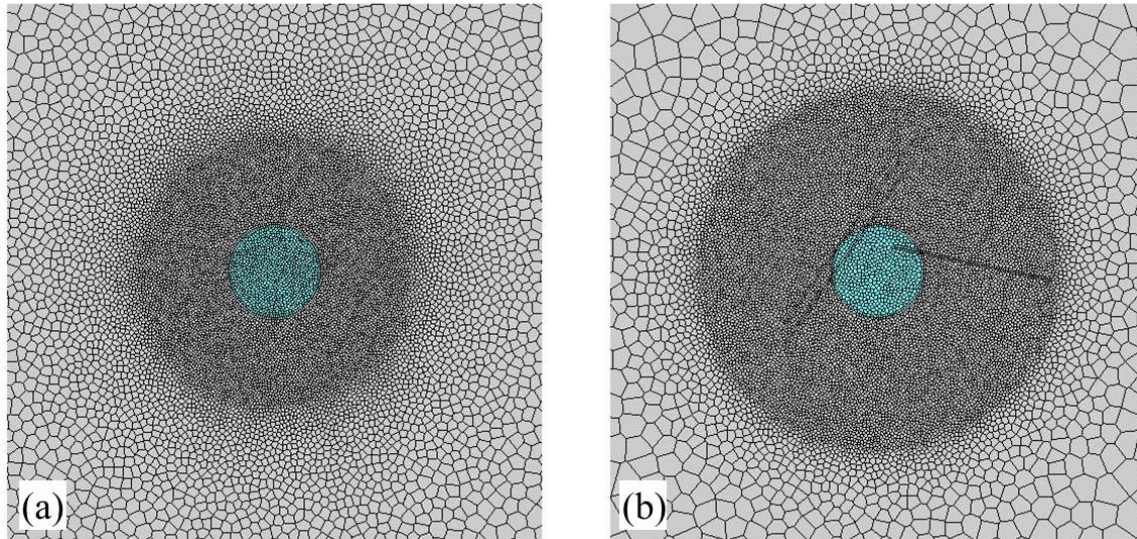

Figure 6.1-22 Discretizations of the computational domain for the HG-A test simulations: a) without fault planes; and b) with fault planes explicitly modeled into the grid (Zheng et al. 2016).

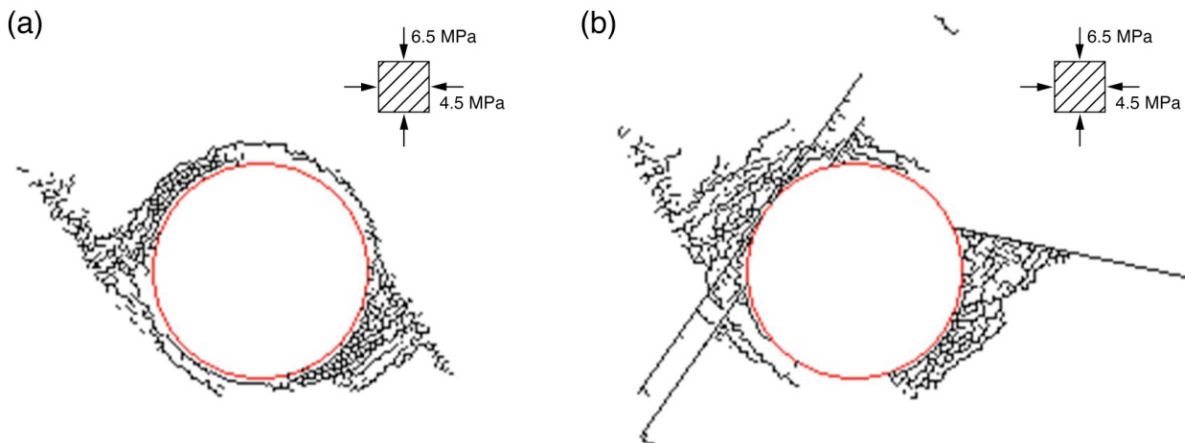

Figure 6.1-23 Resulting failure patterns around the tunnel excavation zone: a) without fault planes; and b) with fault planes (Zheng et al. 2016).

6.1.4 Modeling of THMC Processes in Single Fractures – DECOVALEX Task C1

Various models have been developed for fracture opening and closure as a result of thermal, chemical, or mechanical stresses, with different levels of complexity with respect to process couplings, ranging from a simple geometrical model to a coupled thermal-hydrologic-mechanical-chemical (THMC) model (see Table 1 in Wang et al. 2016). However, those models are to a large extent empirical and thus not amenable for predictions. No existing model is able to provide a consistent explanation for some key features of fracture evolution often observed in laboratory experiments, for example, a spontaneous transition from a permeability reduction to a permeability increase (Polak et al. 2004), an enhancement of fracture permeability by temperature (Yasuhara et al. 2006), or a similar enhancement by a low-pH solution (McGuire et al. 2013). Questions, such as what role a normal stress would play in fracture permeability evolution and under what conditions a fracture would tend to open or close, still remains open (Wang et al. 2016). These questions were at the heart of the DECOVALEX-2015 Task C1, which uses data from single-fracture-flow laboratory experiments to model complex coupled THMC processes, in particular looking at the linkage of thermal stresses mediating chemical effects, and conversely of chemical potentials mediating mechanical behavior (e.g., pressure solution) (Section 3.2.2.4).

From 2014 to 2016, SNL scientists have participated as DOE's modeling team in the interpretation and modeling of DECOVALEX Task C1. A mechanistic understanding of THMC-induced fracture opening and closure in geologic media is of significant importance to radioactive waste isolation (e.g., radioactive waste disposal and carbon sequestration and storage). It has been observed that, under certain circumstances, a fracture can undergo either opening or closure or switch from one regime to another. Fracture evolution involves a complex set of coupled physical and chemical processes, including stress-mediated mineral dissolution and precipitation, fluid flow and transport, mechanical deformation, etc. SNL researchers formulated a dynamic model for subsurface fracture opening and closure (Wang et al. 2015; 2016). It is assumed that a fracture plane can be represented with isolated contacting asperities and connected aperture channels that run through between the asperities. It is further assumed that the cross-section of an individual aperture channel can be described as a truncated ellipse defined by the intersection of two identical ellipses. The model explicitly accounts for the stress concentration around individual aperture channels and the stress-activated mineral dissolution and precipitation. A preliminary model analysis demonstrated the importance of the stress-activated dissolution mechanism in the evolution of fracture aperture in a stressed geologic medium. The model provides a reasonable explanation for some key features of fracture opening and closure observed in laboratory experiments, including a spontaneous switch from a net permeability reduction to a net permeability increase with no changes in experimental conditions (Figure 6.1-24). Once validated, this model can be incorporated into a simulator for large-scale simulations. The model will provide the needed information about fracture permeability evolution for reservoir-scale simulations.

It should be mentioned that several other international teams tackled the same Task C1 challenge in this DECOVALEX Task, and that a variety of modeling concepts were utilized and compared. These ranged from complex highly discretized models that capture the details of fracture topography (Figure 6.1-25) and THMC processes, to homogenized models that treat the entire fracture surface as a single entity, and to synthetic models that use the fracture topography data to define a statistical description of the fracture aperture distribution at different spatial scales and using this to inform physical models. Teams also used models with different process representation, some incorporating stress corrosion or pressure solution, other ignoring these processes, or describing them with bulk properties requiring calibration. This multi-team approach has been very valuable; it has shown that a range of models can be applied to the data and obtains a fit with both the aperture closure and silicon concentration discharge. However, in order to obtain these fits, use of various (often very large and context dependent) 'calibration' factors out of convenience tends to imply that key aspects of the physical model have not always been well captured.

These changes in calibration properties can have plausible physical explanations, but at this point one would have only modest confidence in making forward predictions based on the available physical models under dynamic flow conditions and time dependent thermal loads (Bond 2016).

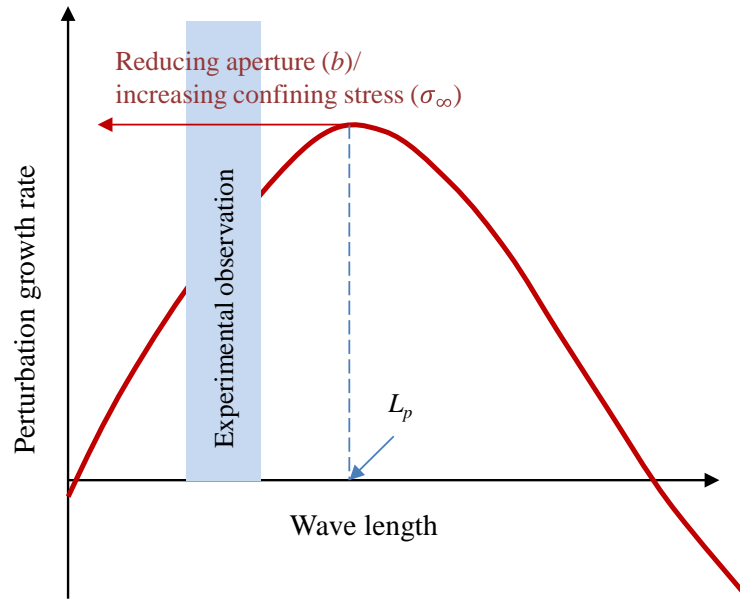

Figure 6.1-24 Spontaneous initiation of aperture channeling. As the fracture aperture reduces due to pressure dissolution, the preferred wavelength of dissolution fingering decreases. Once the preferred wavelength falls within the experimental observation range, a spontaneous initiation of preferential channeling can be observed. This may be responsible for the observed spontaneous switch from a net permeability reduction to a net permeability increase with no changes in a limestone fracture experiment (Wang et al. 2015; 2016).

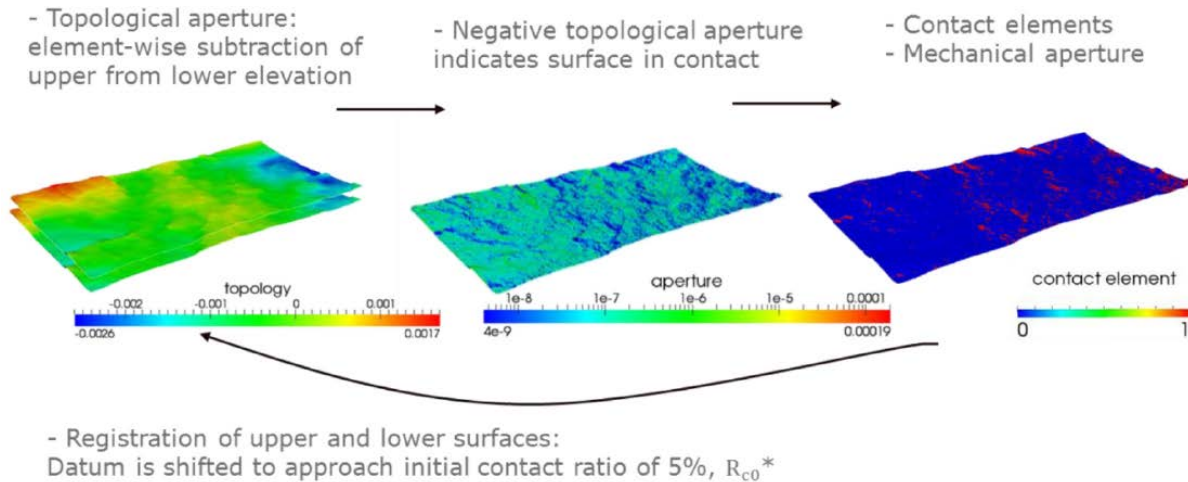

Figure 6.1-25 Schematic illustration of the process of deriving the fracture aperture maps from the laboratory measurements (Bond 2016).

6.1.5 Salt Geomechanics Modeling and Benchmarking

DOE/UFD scientists and their German colleagues in academia and other research laboratories collaborate closely on various R&D issues related to disposal of radionuclide waste in salt (Section 4.2). A MoU was signed a few years ago between DOE and the German Federal Ministry of Economics and Technology (BMWi) to cooperate in the field of geologic disposal of radioactive waste, and a variety of joint R&D projects have been conducted over the years. Below, we provide short descriptions of two such efforts, (1) a collaboration involving SNL scientists which is concerned with benchmarking and improvement of constitutive models in geomechanics simulations of field experiments conducted in bedded and domal salt (Section 6.1.5.1), and (2) a collaboration involving LBNL researchers which uses data from a large-scale heater test conducted in the Asse Mine in Germany to test the applicability of coupled THM models (Section 6.1.5.2).

6.1.5.1 *Reinvestigation into Closure Predictions of Room D at WIPP*

Thermo-mechanical simulations are an essential component of salt repository science. An excavated drift filled with nuclear waste (or other hazardous waste) will creep closed over the course of a few decades. Simulations play an important role in predicting the waste isolation process, and also provide valuable predictions needed for the design and operation salt repositories. To improve relevant simulation capability, SNL researchers in FY16 collaborated with German partners on the Joint Project WEIMOS (Reedlunn 2016). The Joint Projects seek to improve thermo-mechanical simulations of salt repositories through enhancing rock salt constitutive models and general simulation techniques. The scope of work includes calibration of rock salt constitutive models against laboratory experiments, and then benchmarking the models against underground experiments. To date, U.S.-German collaborations have primarily focused on predicting underground experiments in domal salt, rather than bedded salt. Each type of salt formation has advantages and disadvantages, so the Joint Project partners decided recently to exercise their models against in situ experiments in bedded salt. Rooms B and D at the Waste Isolation Pilot Plant (WIPP) in South Eastern New Mexico were a natural choice for this project. Figure 6.1-26 shows the design and dimensions of both rooms, which were instrumented to capture the closure immediately after excavation (Figure 6.1-27). The rooms were unheated for the first 354 days after excavation, and then Room B was heated to measure the closure at elevated temperatures, and causing the horizontal and vertical closure measurements to accelerate and deviate from Room D that remained unheated (Figure 6.1-28). The closure measurements from both rooms were used to validate the Munson-Dowson model (Munson et al. 1989; 1990).

The focus of the milestone report by Reedlunn (2016) is on the development of an improved modeling approach, based on measurements that recorded the horizontal and vertical closure in Room D between 1984 and 1991. Early finite element simulations of salt creep around Room D under-predicted the vertical closure by a factor of about five. Discrepancies between simulations and measurements were resolved through a series of adjustments to model parameters. The Joint Project participants, however, attempted to predict the evolution of the underground drift closure based on laboratory experiments alone. This approach requires a deeper scientific basis, and if successful improves confidence in model predictions and facilitates predictions of a new repository in a new location.

Reedlunn (2016) performed laboratory-based model predictions by updating the legacy simulations conducted for Room D. Argüello and Holland (2015) previously showed that including the anhydrite layers in the stratigraphy reduces the vertical closure predictions by about 20%, although Argüello (2015) was not able to achieve mesh convergence. Reedlunn (2016) was able to resolve the numerical issues and demonstrated mesh convergence, as well as obtained predictions that agreed with the measurements.

To provide the necessary basis for model setup using laboratory experiments, new clean salt and argillaceous salt cores were collected in 2013 from the WIPP drifts and sent to Germany for further testing. The German's collaborators performed a battery of triaxial creep tests, strength tests, petro-physical tests, and permeability tests. Surprisingly, virtually no difference was found between the clean and argillaceous salt creep samples. The creep tests were then used to create two new Munson-Dawson constitutive model calibrations. The simulations using the two calibrations both under predicted the vertical closure of Room D by about a factor of three. The difference occurred mostly in the first 50 days, because the simulations failed to capture the large transient strain jump following the excavation of Room D. Several potential causes for the differences between the predictions and the measurements are now considered (Reedlunn 2016):

1. Creep behavior at low equivalent stresses
2. Extent of the simulation area
3. 1983 reference stratigraphy versus Munson 1989 stratigraphy
4. Creep behavior of clean salt versus argillaceous salt
5. Lost transient strains
6. Sliding at clay seams
7. Anhydrite strength

The German collaborators have begun investigations of the first issue by planning more low equivalent stress creep tests. Based on the results of simulations described by Reedlunn (2016), the Munson-Dawson model should be modified and recalibrated to capture low equivalent stress creep. Once the modified Munson-Dawson model is recalibrated, the second issue can be addressed by changing the size of the finite element model. The remaining issues will likely require varying levels of modeling, field, and experimental support. Results of this ongoing project will help identify deficiencies in both the constitutive model and numerical methods needed for thermo-mechanical simulations of underground experiments, which are an essential component of salt repository science.

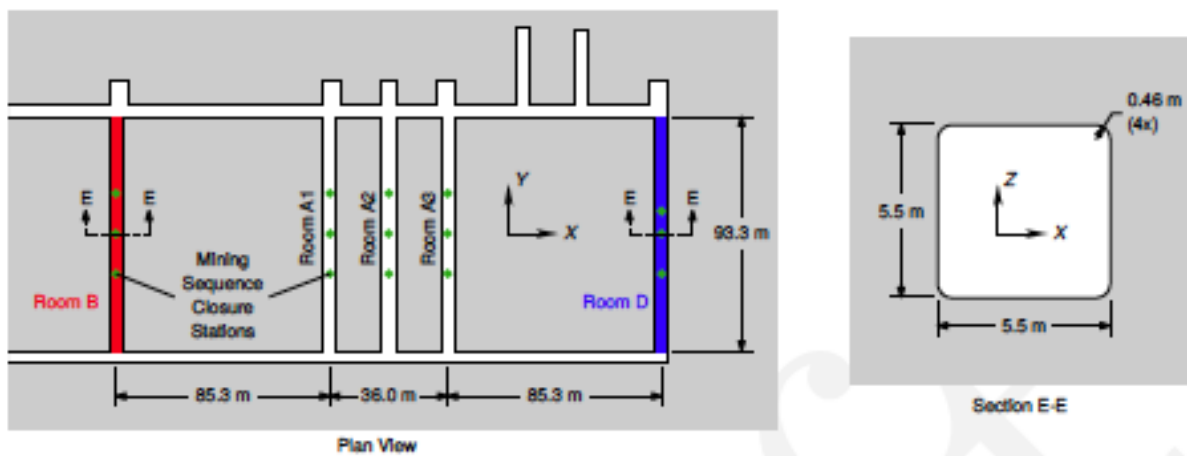

Figure 6.1-26 Rooms B and D dimensions (Reedlunn 2016).

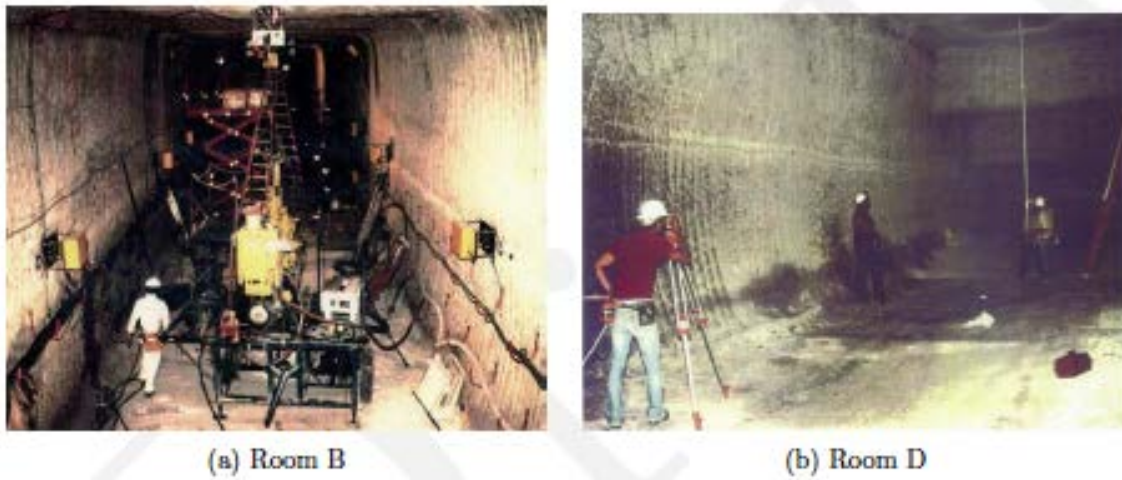

Figure 6.1-27 Photographs of Rooms B and D (Reedlunn 2016).

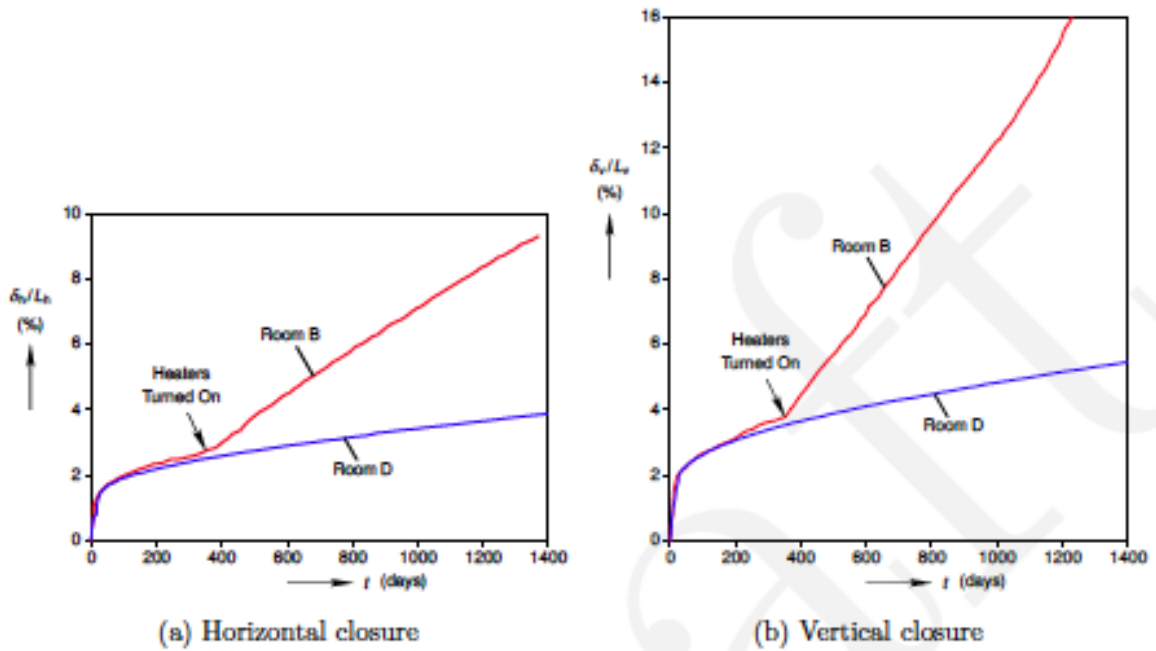

Figure 6.1-28 Horizontal and vertical closure measurements of Rooms B and D (Reedlunn 2016).

6.1.5.2 Modeling Coupled THM Processes and Brine Migration in the TDSE Test

In a parallel US-German effort, researchers from LBNL have been collaborating with a research group led by Professor Lux in Germany at the Clausthal University of Technology (TUC) on modeling coupled THM processes in salt. LBNL incorporated into the TOUGH-FLAC simulator an advanced geomechanical constitutive model for rock salt developed by the TUC group (the Lux/Wolters model), a model that can handle creep, damage, sealing, and healing of the salt as a function of stress, temperature, and pore pressure. In FY15, using the TOUGH-FLAC simulator, LBNL and TUC have started working on THM benchmarking studies involving the TSDE (Thermal Simulation for Drift Emplacement) test conducted in the Asse Mine in the 1990s, Germany (see Section 4.2). The details of the TSDE experiment and TOUGH-FLAC modeling are described in the FY2016 milestone report (Rutqvist et al. 2016), and in the recent journal paper by Blanco-Martin et al. (2016).

The experiment was conducted in two parallel drifts, drilled for the purposes of this test, at a depth of 800 m, in the Northeastern part of the salt dome (Figure 6.1-29). These drifts are both about 76 m long and lie 10 m apart. In each of the drifts, three electrical heaters were emplaced, each of them releasing a constant power of 6.4 kW. The heaters were 5.5 m long and placed in the central part of the drifts, at a constant distance of 3 m. The heaters were emplaced 1.4 years after the excavation of the drifts, parallel to the drifts' axis. The open space was subsequently backfilled with crushed salt, with an initial porosity of 35%. A significant amount of data was measured in 20 monitoring cross sections: temperature, stress changes, displacement, convergence and porosity of crushed salt, among others. These data could be used to validate the large-scale applicability of models developed from laboratory data, and also to calibrate some model parameters whose identification is difficult at the laboratory scale (Bechthold et al. 2004).

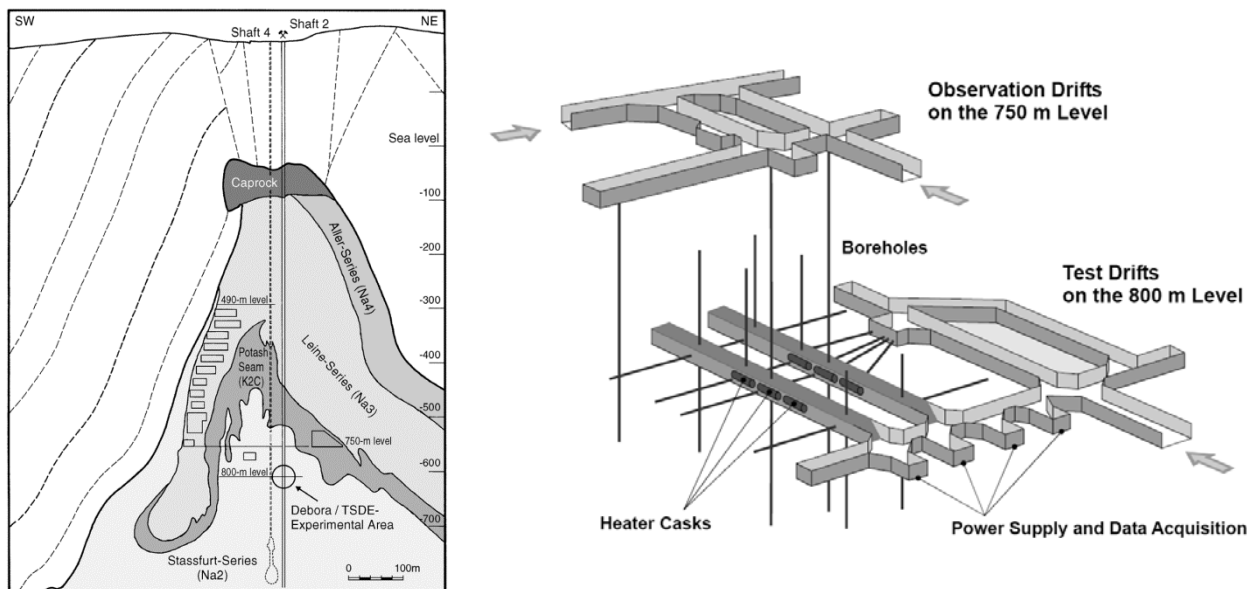

Figure 6.1-29 TSDE test: (a): cross-section of the Asse salt mine, indicating the location of the TSDE experiment; (b): schematic representation of the test area (Blanco-Martin et al. 2016).

A 3D (86,000 elements) TOUGH-FLAC model was developed and applied to simulate the TDSE behavior (Figures 6.1-30). During the 8 years of heating, the temperature at the heater cask reached 210°C after five months of heating, and it decreased thereafter as the thermal conductivity of the backfill increased (due to compaction) (Figure 6.1-31). After about 5 years, temperature in the heater cask area

reached a steady state (160-180 °C at the heater surface), while it continued to increase within the backfill at farther distances from the heater (Figure 6.1-31a). The backfill porosity evolution is displayed in Figure 6.1-31b, for the heated and non-heated areas. The changes in backfill porosity were calculated from horizontal and vertical convergence data. The simulation results show that the closure rate in the heated area increased significantly (factor of about 12) once heating started. Then, the closure rate decreases progressively over time due to the compaction and stiffening of the backfill. The results of numerical modeling are generally in a very good agreement with measurements of temperature and compaction rates (Figure 6.1-31). The difference in compaction rate between heated and non-heated areas is well captured in the modeling. Note though that the numerical closure rate was obtained after the recalibration of three parameters that control the stationary creep of the natural salt host rock (recall that the transient creep finishes during the open drift phase).

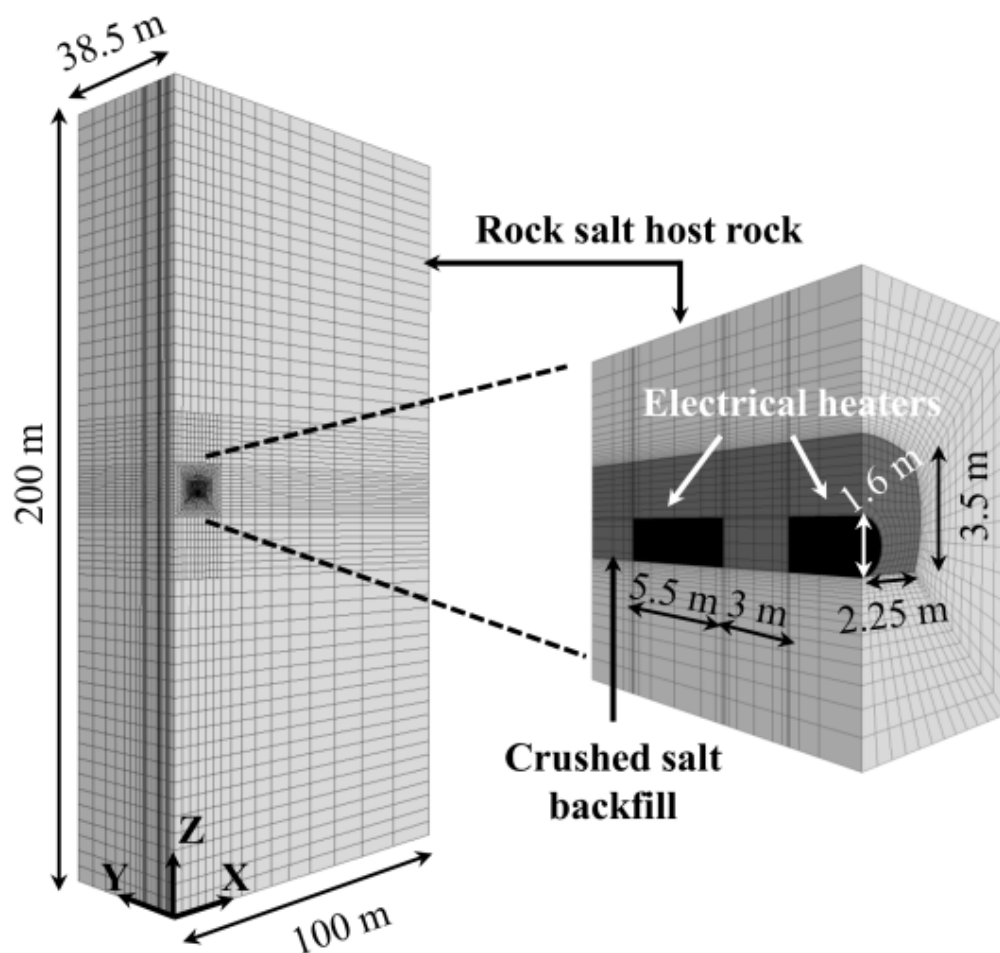

Figure 6.1-30 TSDE test: views of the initial mesh used in the geomechanics sub-problem. The main dimensions of the model are also shown (Rutqvist et al. 2016; Blanco-Martin et al. 2016).

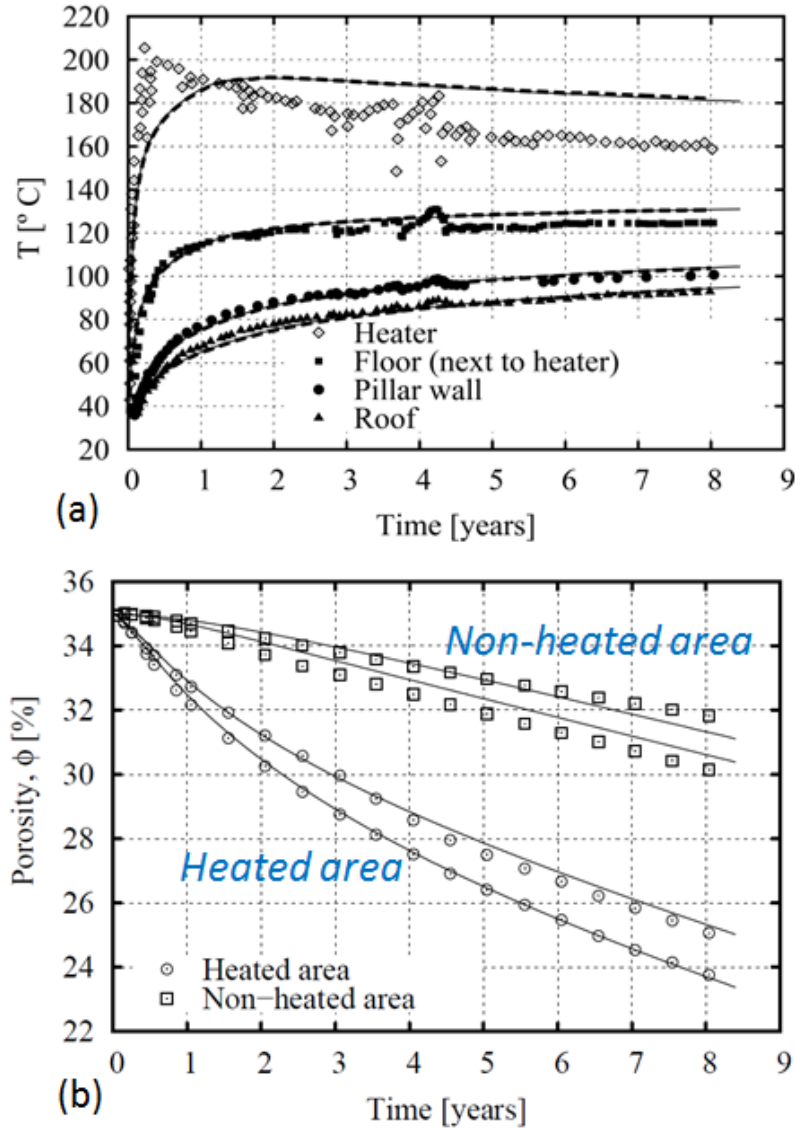

Figure 6.1-31 TSDE test: backfill porosity in the heated area and in the non-heated area. Points represent measurements, solid lines correspond to TOUGH-FLAC and dashed lines correspond to FLAC-TOUGH (Rutqvist et al. 2016).

LBNL’s modeling of the TSDE experiment showed that previously laboratory calibrated creep parameters are not valid for very low deviatoric stresses that prevail *in situ* and therefore the time required for complete drift convergence and sealing could be underestimated. Using creep parameters calibrated against the TSDE *in situ* convergence data, the time to complete convergence and sealing of the backfill in a generic repository extended from tens of years to hundreds of years. Further, our modeling of backfill compaction indicated some deviations in the calculated and measured stress evolution within the backfill. This may be due to the constitutive model for backfill not being adequate to accurately capture the stress evolution, especially at high temperatures. Predictions of the compaction of the backfill and sealing are very important for the long-term performance assessment and therefore *in situ* experiments addressing creep at low deviatoric stress gradient and backfill compaction properties at high temperature would be very useful for reducing the uncertainties of such predictions.

6.2 Fluid Flow and Radionuclide Transport

6.2.1 Using Environmental Tracers to Estimate Fracture-Network Properties: Application to the Bedrichov Tunnel Experiment – DECOVALEX Task C2

In FY16, SNL scientists finalized their participation in the interpretation and modeling of DECOVALEX-2015 Task C2, which is the Bedrichov Tunnel Experiment in the Czech Republic (Section 3.2.2.5). The task utilizes a dataset of environmental tracers and the discharge into the Bedrichov Tunnel, an existing tunnel for a water pipe that is also used for hydrogeological studies. The focus of Task C2 is to assess the possibility of the application of environmental tracers to provide valuable information for constraining parameters controlling flow and transport and making better predictions of contaminant transport in fracture network systems. The high-resolution groundwater discharge data measured in the Bedrichov Tunnel—along with measurements of stable isotopes of water ($\delta^{18}\text{O}$, $\delta^2\text{H}$) and tritium $\delta^3\text{H}$, tritiogenic ^3He , and other noble gases, as well as dissolved chlorofluorocarbons (CFC)—can provide a unique data set against which to test and calibrate numerical models of groundwater flow and solute transport in fractured media. The goal of Task DECOVALEX C2 is to model groundwater flow and transport of environmental tracers in the fracture systems surrounding the Bedrichov Tunnel and utilize these data to constrain fracture-network parameters.

As part of Task C2, SNL scientists initially developed a simple lumped parameter model for stable isotopes, tritium and CFC-12 transport at the Bedrichov Tunnel site, and then compared the modeling results to measured data (Wang et al. 2014; 2015). The lumped parameter model predicted reasonably well heavier isotopic values observed at the site, indicating a possibility of the preferential recharge of winter precipitation (Figure 6.2-1). PFLOTTRAN, a multiphase, multicomponent reactive flow and transport simulator, was then applied to simulate multiple environmental tracer concentrations in heterogeneous 2D and 3D domains (Figure 6.2-2). Fracture-zone permeability was calculated by matching the steady tunnel discharge to the appropriate values given in the description of Task C2. The modeling results demonstrated the usefulness of both the lumped parameter model and the PFLOTTRAN code for evaluating flow and transport behavior in fractured crystalline rocks.

In FY15, SNL scientists continued their interpretative modeling work for Task C2, utilizing several different conceptual models for simulations of the isotopic transport at the site, including models that allow modeling of a vertical fracture zone along with the background matrix (Wang et al. 2015). In the latest set of simulations, the constant recharge, which was used earlier models, was changed to a transient recharge set as 20% of monthly average observed precipitation at the site. The steady state hydraulic field was used as the initial condition, and then the transient recharge was applied across the top of the domain. A transient defined concentration taken as monthly average isotopic concentration was then applied across the recharge zone. The estimated recharge, the calculated discharge, and the observed discharge are plotted below in Figure 6.2-3. Overall there is a reasonable order of magnitude match to the observed discharge. An annual transport sequence of $\delta^{18}\text{O}$, which highlights the seasonal changes in isotopic composition and its transport through the system, is shown in Figure 6.2-4.

In FY16, the objective of SNL's work was to go back to simpler lumped parameter models and investigate different residence (or transit time) distribution approaches, a valuable method when the true distribution of flow paths is not known (Wang et al. 2016). The residence time distribution is a fundamental characteristic of a flow system and provides critical information for determining the parameters controlling flow and transport in the system. Residence time distributions were developed for a variety of simplistic aquifers. These models provide a convenient method to investigate the residence time and flow path distribution in a variety of hydrogeologic systems. Lumped parameter models in

conjunction with tracer transport observations provide a means to investigate the residence time distribution and infer flow path characteristics in a reservoir.

In FY16, the transit time distribution (TTD) of discharge collected from fractures in the Bedrichov Tunnel, Czech Republic, was investigated using lumped parameter models and multiple environmental tracers (Wang et al. 2016). Time series of $\delta^{18}\text{O}$, $\delta^2\text{H}$ and $\delta^3\text{H}$ along with CFC measurements from individual fractures were used to investigate the TTD and the uncertainty in estimated mean travel time in several fracture networks of varying length and discharge. Several transit time distributions, including the dispersion distribution, the exponential distribution, and a developed TTD, including the effects of matrix diffusion, were evaluated. The effect of seasonal recharge was explored by comparing several seasonal weighting functions to derive the historical recharge concentration. Minimizing the error-weighted, multi-tracer χ^2 residual for each seasonal weighting function identified the best fit of mean ages for each TTD. This methodology was used to test the ability of each TTD and seasonal input function to fit the observed tracer concentrations and the effect of choosing different TTD and seasonal recharge functions on the mean age estimation. It was found that the estimated mean transit time is a function of both the assumed transit time distribution and seasonal weighting function. Best fits as measured by the χ^2 value were achieved for the dispersive model using the seasonal input function developed for two of the three modeled sites, while at the third site, equally good fits were achieved with the exponential model and the dispersion model and our seasonal input function. The average mean transit time for all TTDs and seasonal input functions converged to similar values at each location. The sensitivity of the estimated mean transit time to the seasonal weighting function was equal to that of the transit time distribution. These results indicated that understanding seasonality of recharge is at least as important as the uncertainty in the flow path distribution in fracture networks, and that unique identification of the TTD and mean transit time is difficult given the uncertainty in the recharge function. However, the mean transit time appears to be relatively robust to the structural model uncertainty. The results presented here should be applicable to other studies using environmental tracers to constrain flow and transport properties of fractured rock systems.

The different modeling teams participating in DECOVALEX Task C2 conducted a thorough evaluation and a comparison of their respective analyses and simulation results. For most teams the results of modeling were matching each other, and overall all models reproduced the gross characteristics of hydraulic and tracer transport observed in the field. Understanding the discrepancies between models has proven to be a great learning experience for all teams; it enhanced the understanding of the processes and illustrated the strengths and limitations of various approaches and models (Wang et al. 2015; 2016). The results of this study highlighted the difficulty in using tracers to constrain travel time in a fractured network system. The inability to distinguish a single best age distribution using measured tracer concentration is consistent with the findings of McCallum et al (2014) and Solomon et al (2010). The estimated mean age is dependent upon the system's conceptual model. The standard error of the mean travel time estimate (defined as the standard deviation of mean travel times normalized by the average mean travel time) over all travel time distributions and seasonal weighting input functions ranges from 19% at the V4 sampling site to 22.4% at the V6 sampling site. These results indicate that tracer derived mean travel times converge to a similar value consistent with Solomon et al (2010), and can still be used to provide significant constraint on a complex flow system.

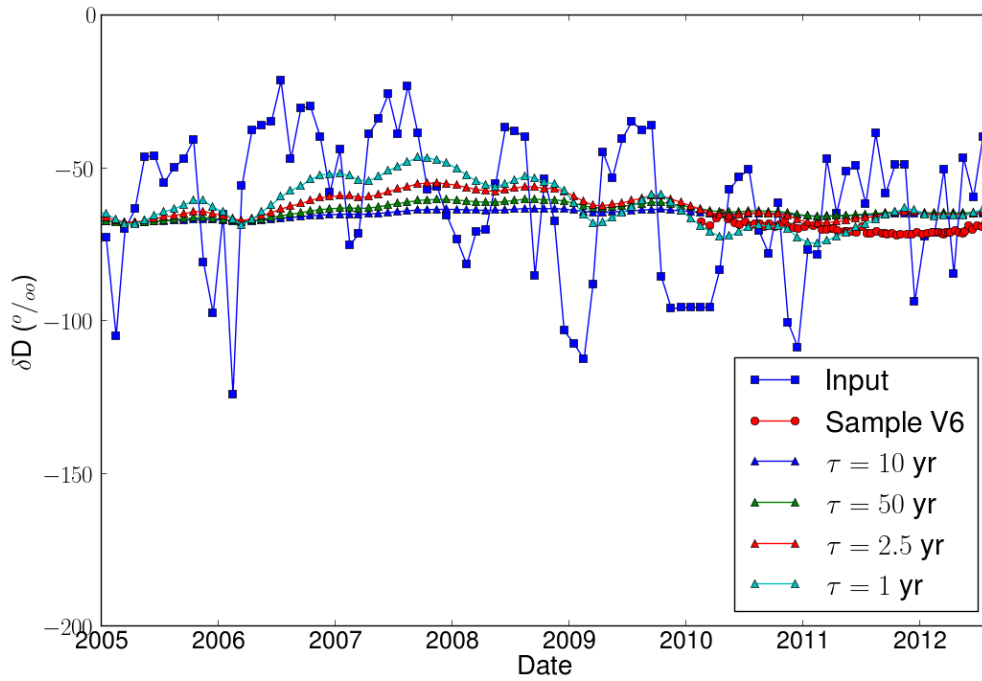

Figure 6.2-1 Measured and modelled stable isotope δD compositions for the Bedrichov collection canal using the exponential age distribution (Wang et al. 2014).

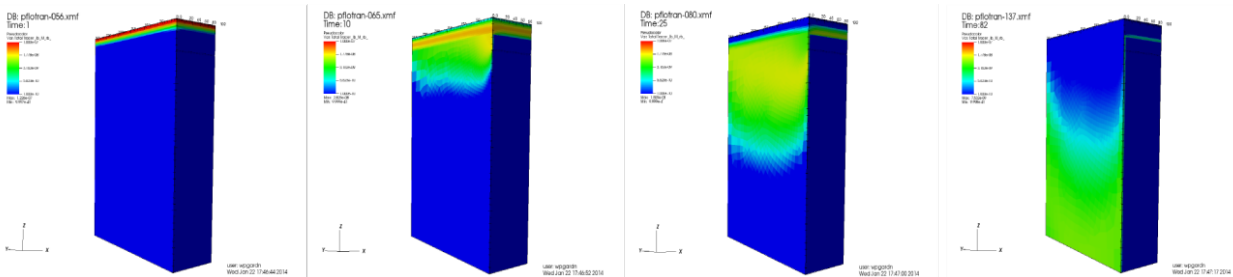

Figure 6.2-2 Transport sequence of tracer migration from a selected PFLOTRAN simulation run. Note that tracer concentration is contoured in log scale. Fracture plane on left side of domain, tunnel on right (front) of domain (Wang et al. 2014).

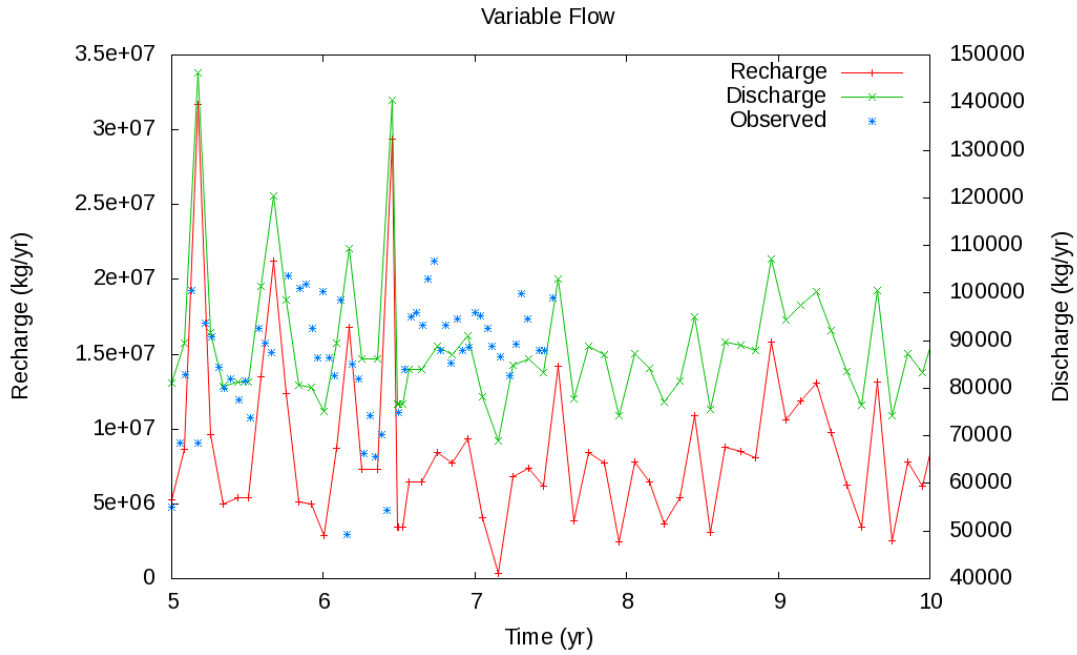

Figure 6.2-3 Transient recharge, modeled fracture discharge and observed discharge (Wang et al. 2015).

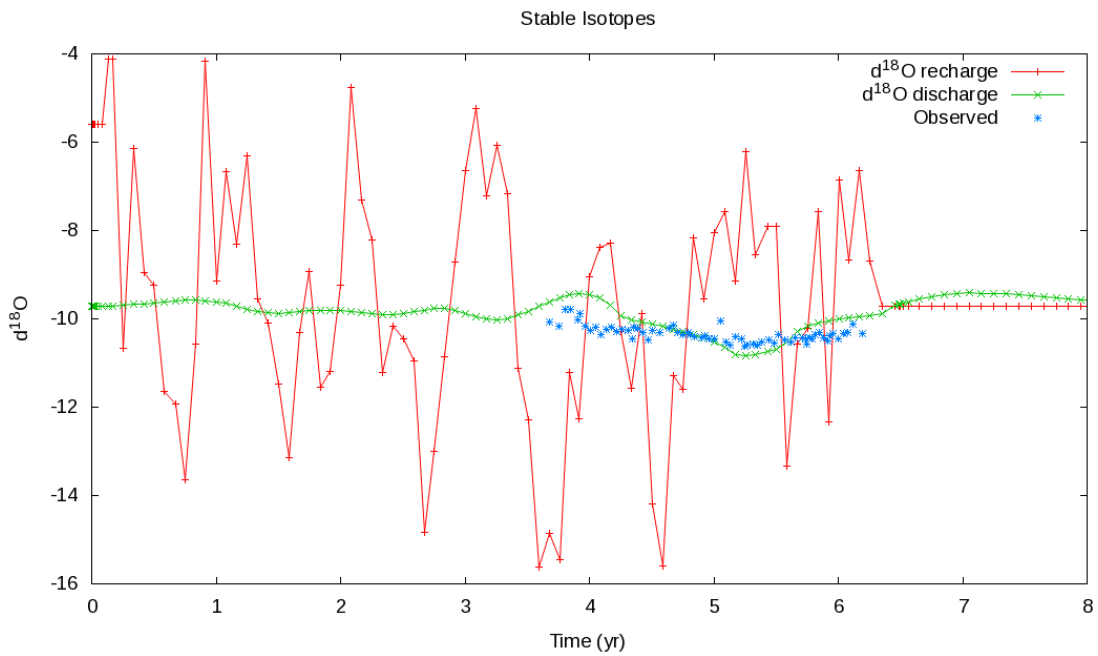

Figure 6.2-4 Transient $\delta^{18}\text{O}$ in precipitation (red line), modeled $\delta^{18}\text{O}$ in the fracture outflow (green line) and observed $\delta^{18}\text{O}$ (blue dots) in fracture outflow (Wang et al. 2015).

6.2.2 Modeling Two Diffusion and Sorption Experiments in Crystalline Rock

In FY16, researchers at LANL started with a new modeling task under the umbrella of the SKB GWFTS Task Forces, referred to as Task 9 (Section 3.4.2.2). The focus of this task is on the modeling of coupled matrix diffusion and sorption in heterogeneous crystalline rock matrix at depth. This is done in the context of predictive and inverse modeling of tracer concentrations measured in two *in-situ* experiments performed within LTDE-SD at the Äspö HRL in Sweden as well as within the REPRO project at Onkalo URL in Finland, focusing on sorption and diffusion. The ultimate aim is to develop models that in a more realistic way represent matrix retardation in the natural rock matrix at depth.

LTDE-SD, the Long-Term Diffusion Sorption Experiment, was completed in 2010 (Section 3.4.2.2). The experiment was designed to examine diffusion and sorption processes in both matrix rock and a typical conductive fracture identified in a pilot borehole. A cocktail of nonsorbing and sorbing tracers was circulated between two boreholes in packed-off sections for a period of 6 ½ months, after which the borehole was overcored and the extracted rock analyzed for tracer penetration and fixation. Tracer concentrations as well as other environmental parameters were monitored during the 200 days the tracer test progressed. Tracer concentrations (or activities) in the rock were obtained by a number of analysis methods, including autoradiography on intact samples; direct activity measurements on intact and crush samples; and leaching or dissolution of intact and crush samples, followed by water phase measurements. Results from the overcored rock volume in LTDE-SD provide concentration profiles in the rock matrix that are not fully understood to date. Figure 6.2-5 shows experimental concentration profiles, here for cesium, in comparison with predictive simulations, showing obvious discrepancies between the results. LANL's working hypothesis is that the major transport of injected tracer into the crystalline matrix occurs not via diffusion but through multiple micro-fractures, which are observed in the rock samples. This could potentially explain the much deeper penetration of cesium as would be expected from purely diffusive transport.

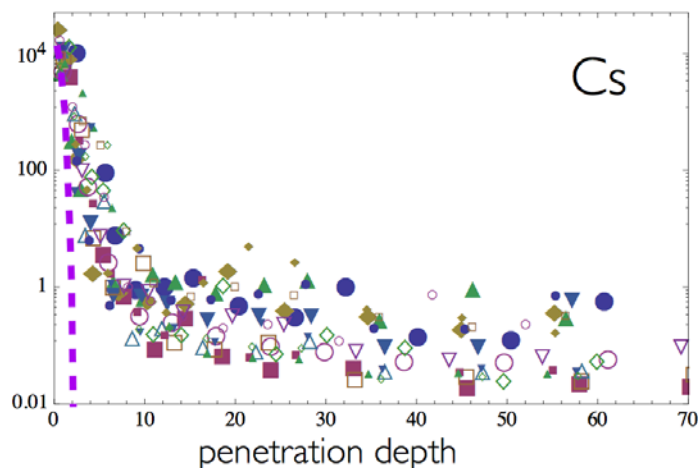

Figure 6.2-5 The measured experimental shapes of the Cs penetration profile (symbols) do not satisfy modeled penetration profile (dashed line). Penetration depth is given in cm (Viswanathan et al. 2016).

LANL scientists started testing this hypothesis using a powerful discrete fracture modeling tool that can handle small scale micro fracture networks with given micro fracture statistical characteristics. Figure 6.2-6 shows the connected network of micro fractures developed for the LTDE-SD test embedded into a matrix continuum model such that the transport simulation can account for fracture advection and porous matrix diffusion. The massively parallel reactive flow and transport model PFLOTRAN (Lichtner et al.

2015) was then used to simulate transport through the simulation domain. Example results are shown in Figure 6.2-7. One can see that tracer concentration is not uniform along the fluid flow direction; the micro-fracture cells provide faster paths for tracer than rock matrix cells due to higher permeability and higher porosity. In Figure 6.2-8, tracer concentration is plotted versus penetration depth to allow for comparison with Figure 6.2-5, for two modeling cases: the fractured system simulation, where a DFN is mapped onto the matrix continuum (blue line), and just the matrix continuum simulation (dashed green line). We can see that the pure diffusion case in the matrix continuum model (without fractures), shown by a dashed line, is different from the fractured continuum simulation and the experimental results.

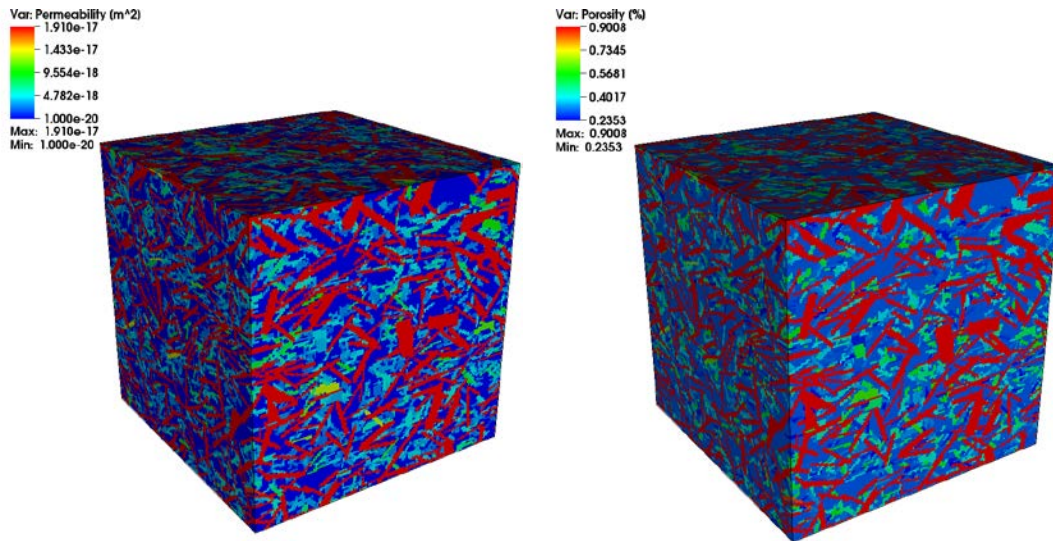

Figure 6.2-6 Permeability (left) and porosity (right) profiles are shown in the fracture continuum simulation (Viswanathan et al. 2016).

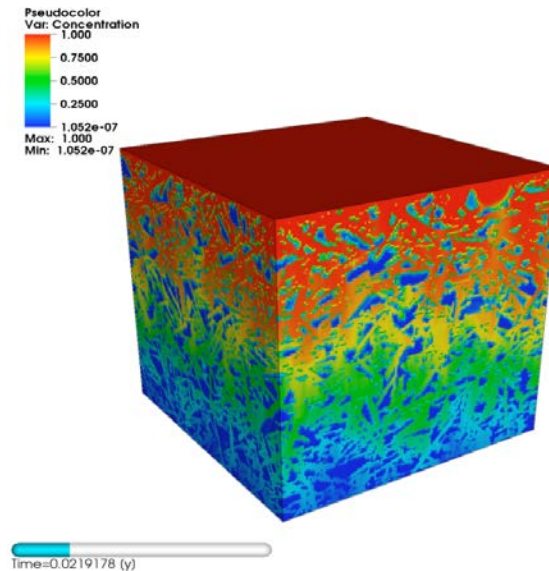

Figure 6.2-7 Tracer concentration of transport modeling in fractured continuum (Viswanathan et al. 2016).

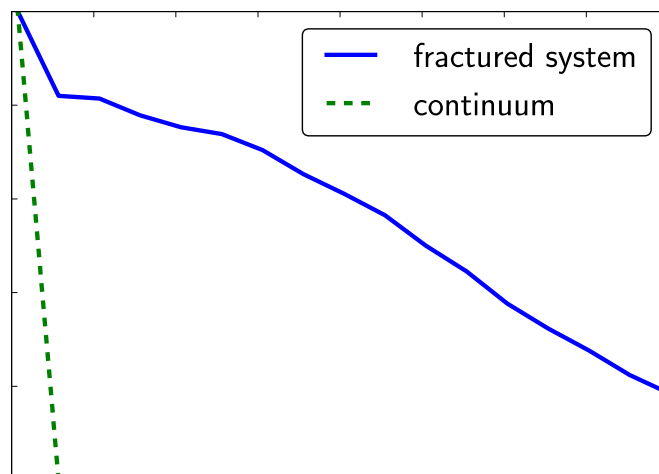

Figure 6.2-8 Simulation results of tracer concentration plotted versus tracer penetration depth. Blue line corresponds to fractured continuum model with simulated ADE, dashed green line shows results for uniform continuum with simulated pure diffusion process (Viswanathan et al. 2016).

The second experiment in Task 9 is the REPRO (**R**ock matrix **r**Etention **P**ROperties) experiment, which is presently carried out by Posiva at the ONKALO underground rock characterisation facility in Finland (Section 3.4.2.2). REPRO involves a number of boreholes that have been drilled into the non-fractured rock matrix from a working niche at the Onkalo underground rock characterization facility, at about 400 m depth (see Figure 6.2-9). Borehole ONK-PP323 is utilized for the Water Phase Diffusion (WPDE) series of experiments, which are advection-diffusion-sorption tests. To date, two experiments have been performed at different flow rates; WPDE-1 (20 $\mu\text{L}/\text{min}$) and WPDE-2 (10 $\mu\text{L}/\text{min}$). The tracer concentrations were measured in water flowing out of the experimental section, both by on-line Na(Tl)I-scintillation detection and by analyzing water samples in the laboratory. Breakthrough curves have been obtained over half a year and about one and a half a year for WPDE-1 and WPDE-2, respectively. REPRO also involves a second experiment method, referred to as the Through Diffusion Experiment (TDE), which will be carried out between three parallel boreholes situated perpendicular to each other, in 1 m long packed-off sections, at a distance of about 11 to 12 m from the tunnel wall. Borehole ONK-PP326 will be used as the injection hole and boreholes ONK-PP324 and ONK-PP327 as observation holes (see Figure 6.2-9, upper left corner). The distances between the boreholes are between 10 and 15 cm.

LANL's work on the REPRO experiment started with the development of high quality computational meshes for the WPDE and the TDE. A cube of size 1.9 m x 1.9 m x 1.9 m was generated for the WPDE experiment modeling, where only one borehole, drilled into non-fractured rock matrix, is considered). First, the structured tetrahedral mesh was produced in the cube. Then, the borehole of 56 mm diameter was created on the center of the cube (Figure 6.2-9, right panel). Producing the cylindrical hole, this represents the borehole in the rock, required to reform the structural grid to an unstructured circular grid around the borehole. The mesh of the borehole was generated separately. The cylinder of 54 mm diameter represents the dummy placed into the larger borehole, creating the gap (or fracture), see Section 3.4.2.2. The last step was to merge three-dimensional unstructured mesh of the cylinder with the cube, generating a 1 mm meshed layer between the dummy filled borehole and the rock matrix. A similar procedure was

applied to generate the mesh for the TDE experiment, where three boreholes are considered in non-fractured rock. Figure 6.2-9 shows the final grid developed for the TDE, illustrated along a cross section including the boreholes. The entire mesh consists of 133,650 nodes and 740,174 tetrahedral elements. Initial model simulation using these grids will be conducted in early FY17.

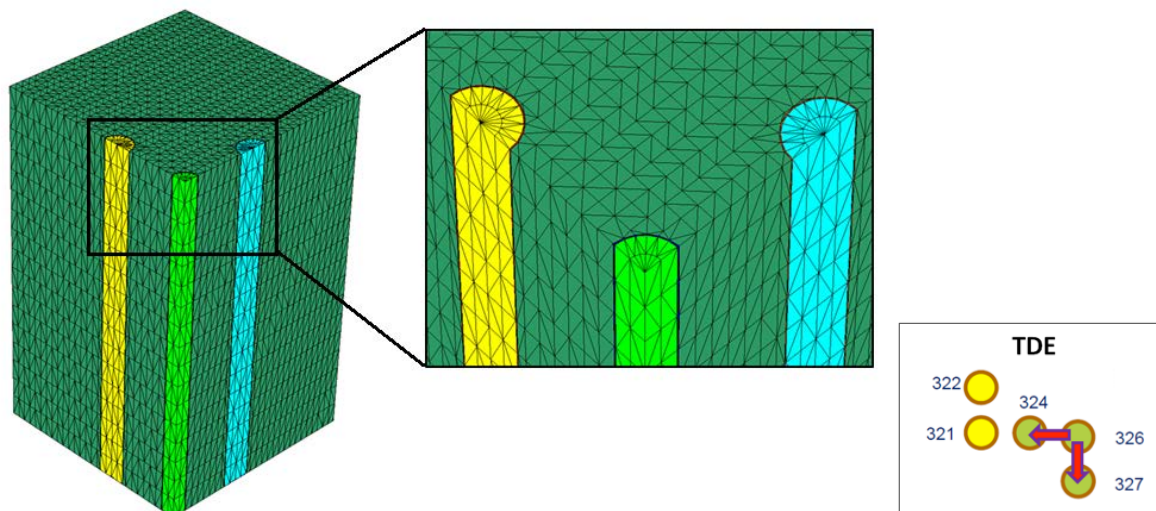

Figure 6.2-9 The cross section of the entire mesh along the boreholes, along z direction. The distance between central borehole and two others is 0.15 m. the zoom in figure shows the mesh of dummy filled boreholes and 1 mm layer between dummy and rock matrix (Viswanathan et al. 2016).

6.2.3. Analysis of Colloid-Facilitated Radionuclide Transport

As part of the Colloid Formation and Migration Project (CFM, Section 3.3.1), UFD scientists from LANL and LLNL have conducted various activities to quantify radionuclide transport associated with colloids. Although DOE’s formal partnership in CFM ended in 2015, UFD researchers continued in FY16 to collaborate with their international partners. For example, LANL performed interpretative analysis of CFM field measurements over the past few years (Section 6.2.3.2). Furthermore, Reimus et al. (2016) give a comprehensive synthesis of the current state of knowledge of colloid-facilitated radionuclide transport from a nuclear waste repository risk assessment perspective in a recent overview report. The report, briefly summarized in Section 6.2.3.1 below, draws heavily on findings from the extensive and carefully controlled set of colloid-facilitated solute transport experiments conducted at GTS.

6.2.3.1. Synthesis of Colloid-Facilitated Radionuclide Transport

Colloid-facilitated transport is generally considered one of the most important transport mechanisms of radionuclides over significant distances in groundwater in geological media. Since 2013, LANL scientists conducted investigations of colloid-facilitated radionuclide transport and colloid breakthrough, conducted as part of the Colloids Formation and Migration (CFM) partnership, an international collaboration of scientists studying colloid-facilitated transport of radionuclides at both the laboratory and field-scales in a fractured crystalline granodiorite at the Grimsel Test Site in Switzerland (Section 3.3.1). CFM tests and associated analysis provided valuable data on how colloids released due to swelling and erosion of a bentonite plug will transport radionuclides through a preferred flow paths such as a shear zone. The synthesis report by Reimus et al. (2016) summarizes the research conducted as part of the 3-year DOE

membership in the CFM partnership and provides a nice overview of the main findings for these studies. For example, Reimus et al. (2016) concluded that there are two primary regimes for significant colloid-facilitated radionuclide transport, which are illustrated graphically in Figure 6.2-10:

- Transport Regime 1.** A small fraction of radionuclide mass can transport essentially conservatively through a flow system under the following conditions: (a) radionuclide desorption from colloids is slow (i.e., a measurable fraction of radionuclide mass remains associated with colloids during the travel time of a conservative species through the flow system), and (b) colloid filtration rates are slow enough that some fraction of the colloids that bear the slow-desorbing radionuclides transports through the system without filtration. In the former case, after the initial breakthrough, the concentration of the colloid-associated radionuclide will increase by approximately an order of magnitude for every order of magnitude increase in time up until the solute front of the radionuclide arrives.
- Transport Regime 2.** If rates of radionuclide adsorption to and desorption from the colloids are rapid relative to conservative travel times through the flow system *and* the product of the mobile colloid concentration and the effective radionuclide partition coefficient onto the colloids is significantly greater than about 0.1, then a large fraction of radionuclide mass can be effectively transported through a flow system. The breakthrough of radionuclide will consist of significant fractions of colloids in a solution, with the colloid-associated fraction. For this transport regime, the filtration rate of colloids does not affect radionuclide transport as long as the concentration of mobile colloids remains constant, i.e., the radionuclide adsorbs and desorbs rapidly enough from colloids regardless of the colloid filtration.

Although these regimes are not necessarily mutually exclusive, they are considered the two end-members of concern for the nuclear waste repository risk assessment. A hybrid regime of Regimes 1 and 2 can develop under the following conditions: radionuclide adsorption to and desorption from colloids is slow (relative to transport times), but radionuclide concentrations are high enough, and/or radionuclide adsorption rates onto colloids are fast enough, so that the fraction of radionuclide mass is transported rapidly on colloids.

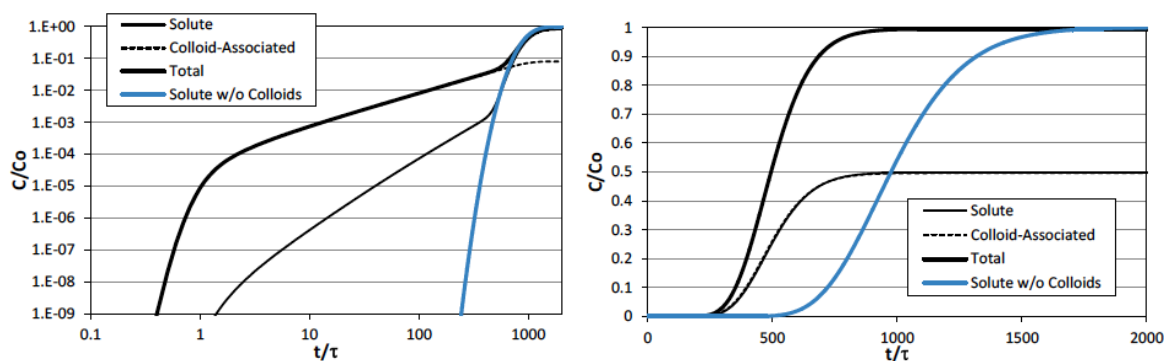

Figure 6.2-10 (a) Colloid-facilitated Transport Regime (1): Early, essentially conservative, breakthrough of a small fraction of radionuclide mass associated with colloids, and (b) Colloid-facilitated Transport Regime (2): Early (but not conservative) breakthrough of a large fraction of radionuclide mass that transports with a reduced retardation factor because of colloid association (Reimus et al. 2016).

Reimus et al. (2016) discussed modeling approaches for colloid-facilitated transport. Relatively mature models exist for describing colloid-facilitated radionuclide transport, including models that are relatively simple and make several limiting assumptions. In case of relaxing a number of simplifying assumptions (such as reversible or partially reversible colloid filtration, slow radionuclide adsorption to and desorption

from immobile surfaces), a model for simulation colloid-facilitated radionuclide transport becomes quite complex. A more sophisticated model should take into account the presence of multiple radionuclide adsorption sites with different rate constants on both immobile surfaces and colloids. Furthermore, for multiple types of colloids there will be a heterogeneous population of filtration and resuspension rate constants, which should be simulated using a number of limitations on either reversible or irreversible filtration sites on immobile surfaces. In a case of a dual-porosity system, a model should also take into account a diffusive mass transfer of radionuclides between the primary (i.e., flowing) and secondary (e.g., matrix/nonflowing) porosity. The report by Reimus et al. (2016) provides a detailed description of the equations for modeling mass fractions and retardation factors.

From the standpoint of nuclear waste repository risk assessments, the radionuclides generally considered to be of greatest concern for colloid-facilitated transport are the long-lived isotopes of Pu, Am, and Np (the latter under reducing conditions). The transport of radioisotopes of other actinides or lanthanides (e.g., Cm, Th, Pa, Ce, Eu - not intended to be all inclusive) would also be expected to be dominated by colloid-facilitated transport, but the inventories of these nuclides are typically much lower than those of Pu, Am and Np in high-level nuclear waste, so they generally contribute less to overall risk calculations. The transport of Cs fission-product isotopes are also expected to be strongly influenced by colloids, but the half-lives of these isotopes are short enough and/or their inventories small enough that they typically impact risk calculations only for a limited number of low-probability scenarios that involve early releases and rapid transport. Isotopes of uranium represent a special case of very high-inventory (at least for used fuel), long-lived radioisotopes that have the potential to contribute significantly to risk calculations, but their transport is generally considered to be dominated by solute processes, not colloid-facilitated transport processes. This is particularly true under oxidizing conditions because U(VI) is quite soluble and does not interact strongly with most surfaces. However, exceptions may occur in highly-reducing environments where the relatively insoluble and adsorptive U(IV) oxidation state is dominant, or in cases where U remains incorporated into waste form alteration colloids.

6.2.3.2. Modeling Colloid-Facilitated Transport for CFM Tests at Grimsel Test Site

In FY16, LANL continued quantitative interpretation of radionuclide transport and colloid breakthrough from tests conducted under the umbrella of the CFM project (Section 3.3.1). Three colloid-facilitated radionuclide transport experiments were conducted at the GTS between 2002 and 2013, and three additional colloid-facilitated homologue transport experiments were conducted between 2008 and 2010. The results and interpretations of all these experiments have been presented and discussed in the milestone reports as follows: Wang et al. 2013, (Ch. 2); Wang et al. 2014b, (Ch. 7); Viswanathan et al. 2016, Ch. 2). These tests serve to illustrate the experimental approach of varying transport times in the same system to gain insights into the time-scale dependence of both radionuclide/homologue desorption rates from colloids and colloid filtration rates. The purpose of LANL's FY16 work was to provide internally consistent interpretations of the various colloid-facilitated radionuclide transport experiments so that the model parameters describing colloid-facilitated transport can be compared and contrasted in the same configuration at different shear zone residence times and in different parts of the shear zone but at similar residence times. These comparisons were expected to yield insights into both the time-scaling behavior of colloid-facilitated radionuclide transport and the heterogeneity of transport properties with the shear zone.

The interpretation of breakthrough curves in the CFM tracer tests was conducted using a semi-analytical model referred to as RELAP (REactive transport LAPlace transform) (Reimus et al. 2003) as well as a more sophisticated 2D numerical model (Reimus 2012). RELAP uses a Fourier transform inversion method to solve the Laplace-domain transport equations in either a single- or a dual-porosity system. The model can account for diffusion between fractures and matrix, as well as linear, first-order reactions in

both fractures and matrix. The very rapid execution of the model makes it ideal for the numerous simulations needed for transport parameter estimation. For each test, RELAP was first applied to fit the conservative tracer extraction breakthrough curves by adjusting the mean residence time and Peclet number in the shear zone (Peclet number is transport distance divided by longitudinal dispersivity) as well as the fractional tracer mass participation in each test. In addition to providing estimates of shear-zone transport parameters for the conservative tracers, RELAP was also used to estimate colloid transport parameters (filtration and resuspension rate constants). These estimates were obtained by assuming that the mean residence time, Peclet number, and fractional mass participation estimated for the conservative tracers also applied to the colloids, and then the filtration-rate parameters were adjusted to fit the colloid data. The resulting best-fitting parameters from RELAP were used as initial parameter estimates in a 2-D numerical model that could account for processes that RELAP does not explicitly account for. The most important of these processes were the variable injection flow rates observed in one of the field experiments and the simultaneous transport of colloids and reactive solutes in all the tests (RELAP does not account for interacting species).

It was found that once appropriate mean residence times, Peclet numbers and fractional mass participations were determined for the conservative tracer breakthrough curves in each test, and filtration parameters were determined for the colloids, the model fits to the colloid-facilitated solute breakthrough curves were sensitive mainly to the desorption-rate constants of the solutes from the colloids. The best fits to the field data were obtained when (1) the rate constants for solute adsorption to the shear-zone surfaces were large enough that the solutes rapidly adsorbed to these surfaces after they desorbed from the colloids and (2) the rate constants for solute desorption from the shear-zone surfaces were small enough that the solutes effectively did not desorb from these surfaces for the remainder of the tests. Under these conditions, the shear zone surfaces act as a fast and irreversible sink once desorption from colloids occurs. Because the tri- and tetravalent solute desorption process from colloids appeared to be so important, LANL researchers implemented into their models alternative descriptions of the solute associations with the colloids and tested these against the measured breakthrough curves from the CFM experiments. Figures 6.2-11 and 6.2-12 show sample results for the model fit to the breakthrough curves for various radionuclides and colloids. Overall, the simulated and measured breakthrough curves show excellent agreement, indicating the relevant processes driving colloid-facilitated transport are reasonably accounted for in the RELAP analysis, at least at the scale of the CFM test facility.

The comprehensive model interpretations presented in Viswanathan et al. (2016) for all the CFM tests involving reactive radionuclides at the Grimsel Test Site yield valuable insights for modeling of radionuclide transport, and particularly of colloid-facilitated radionuclide transport, in saturated fractured crystalline rocks. Nonuniqueness in the model interpretations was reduced by minimizing the differences in the reactive transport parameter estimates for a given radionuclide in different tests, with the rationale being that all the tests were conducted within a few meters of each other in the same shear zone, so the model parameters for a given radionuclide should be similar in all tests. However, nonuniqueness in the parameter estimates could not be completely eliminated, particularly for parameters for which the model simulations of a given radionuclide were insensitive. For the most part, a relatively consistent set of reactive transport parameter estimates was obtained for each radionuclide, and these could be readily applied to all CFM tests in which that radionuclide was injected. However, adjustments to the most sensitive reactive transport parameters were inevitably necessary to improve model matches to breakthrough curves for a given radionuclide when interpreting different tests. Some of these adjustments can be readily justified as being attributable to differences in injection concentrations of the radionuclides or to differences in the locations of the tests in the shear zone.

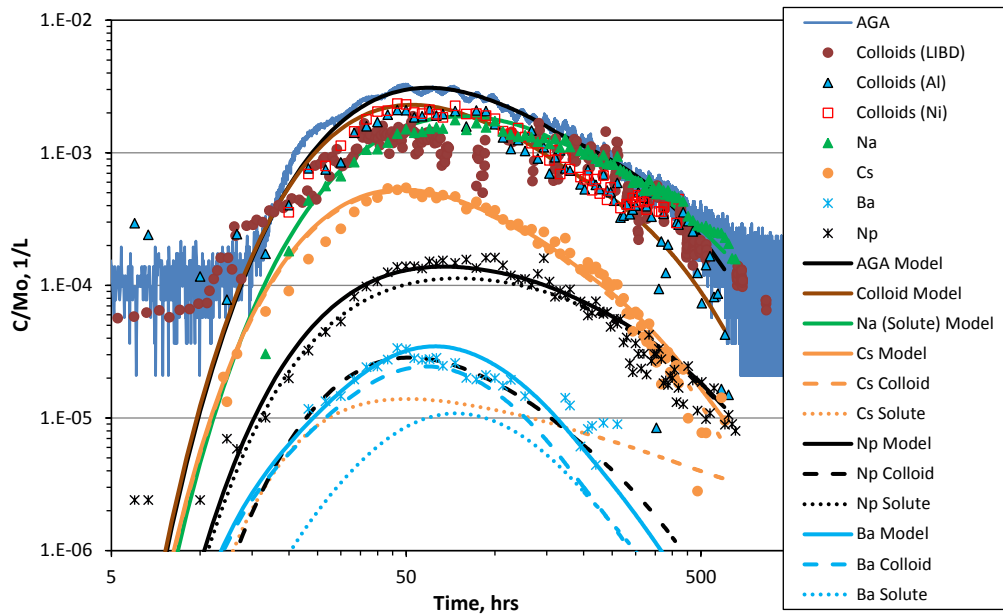

Figure 6.2-11 Model matches to the AGA, colloid, Na, Cs, Ba and Np breakthrough curves of CFM Run 12-02. Modeled solute and colloid contributions shown (Viswanathan et al. 2016).

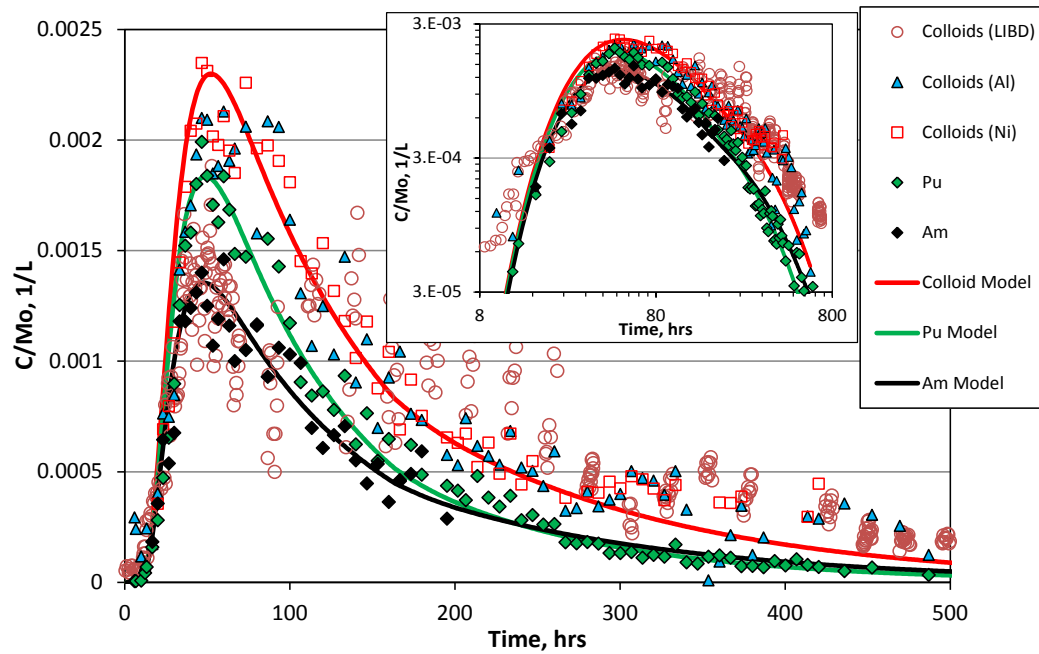

Figure 6.2-12 Model matches to the colloid, Pu, and Am breakthrough curves of CFM Run 12-02. Both species modeled as colloid-facilitated transport (Viswanathan et al. 2016).

6.3. Characterization and Monitoring Techniques

6.3.1. R&D Cooperation with KAERI at the KURT URL

As part of ongoing bilateral collaboration between U.S. DOE and the Republic of Korea (Section 4.1), researchers at SNL have developed a multi-year plan for joint field testing and modeling to support the study of high-level nuclear waste disposal in crystalline geologic media (Wang et al. 2015; 2016). In FY16, SNL and KAERI completed the task on streaming potential (SP) testing, and initiated a new task on the development of a technique for in-situ borehole characterization. The new task is a joint effort between the UFD deep borehole disposal work package and the crystalline disposal R&D work package. In FY16, KAERI also provided the data on THM properties and specifications of bentonite buffer materials. For the streaming potential testing, a sandbox experiment was established at KAERI to study the hydroelectric coupling. Below we briefly summarize results from the R&D collaboration with KAERI regarding the streaming potential.

The SP method is a geophysical technique that is sensitive to the movement of groundwater in real time. The method is based on the idea that the streaming of water through subsurface porous media or fractured rock can produce a natural electrical potential (called streaming potential) along the flow path. The objective of the collaborative R&D between SNL and KAERI is to evaluate whether the SP method can be used to estimate solute transport characteristics of an aquifer. The joint research team conducted tracer tests under steady-state groundwater flow condition with recording SP signals (Wang et al. 2015; 2016). An acrylic tank was filled with medium- to coarse-grained sand and infiltrated with water (Figures 6.3-1 to 6.3-4). Preliminary testing and numerical simulations were used to design the sandbox and regime of the tracer injection. The hydraulic conductivity of the sandbox was estimated from the groundwater flow tests with various hydraulic head differences between upstream and downstream reservoirs. The hydraulic conductivity was estimated to be $2.5 \times 10^{-4} \pm 2.09 \times 10^{-5}$ m/sec. Figure 6.3-3 displays the results of numerical simulations of the tracer test. The results show that the injection rate of 0.005 l/sec into the second screened well and the head difference less than 5 cm were sufficient for running the experiment in the sandbox.

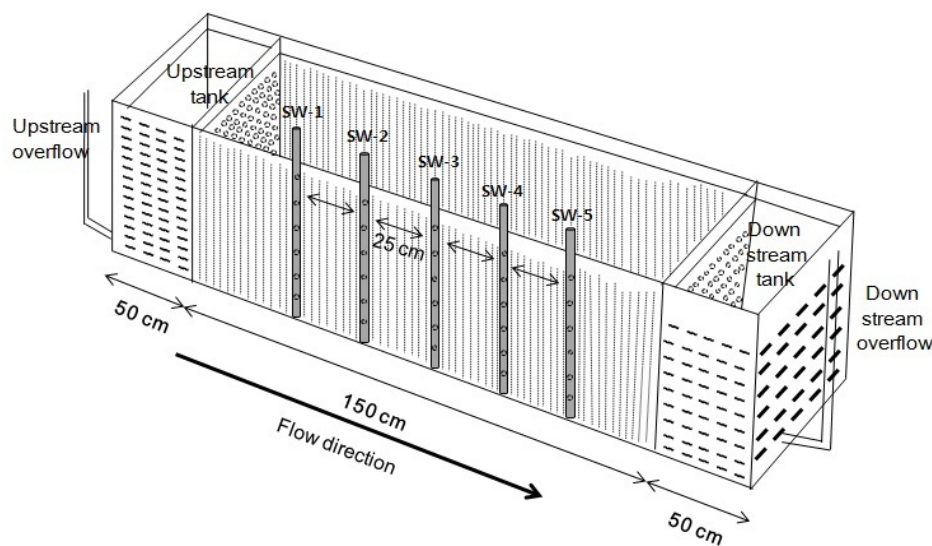

Figure 6.3.-1 3-D view of sandbox design (Wang et al. 2015; 2016)

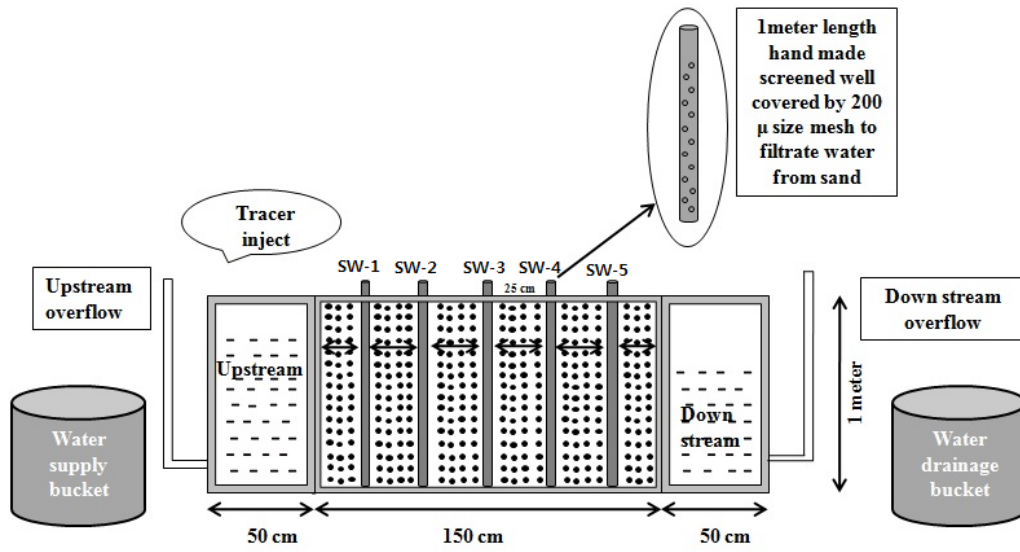

Figure 6.3-2 Cross-sectional view of sandbox design (Wang et al. 2015; 2016)



Figure 6.3-3 Full setup of a sandbox experiment (Wang et al. 2015; 2016)

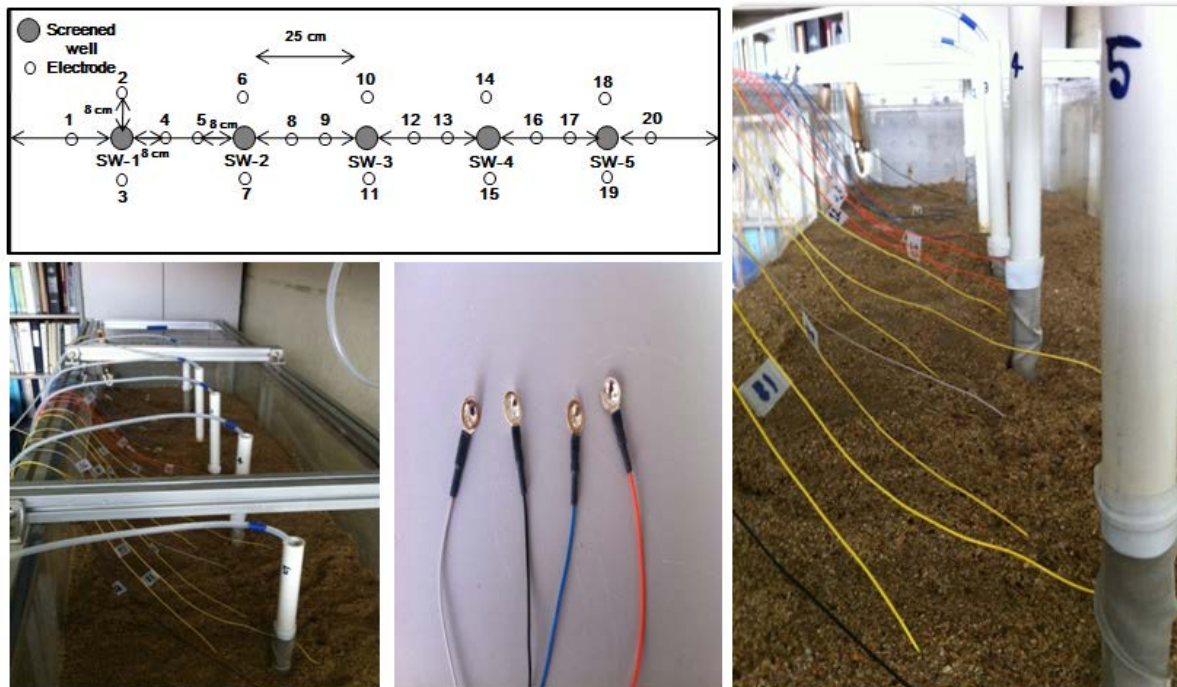

Figure 6.3-4 Electrode set up into the sandbox (Wang et al. 2016)

Tracer injection tests were performed in the sandbox using a peristaltic pump, and tracer samples were collected from the same depth interval of five screened wells in the sandbox. During each tracer test, SP signals from 20 nonpolarizable electrodes were measured at the top of the tank by a multichannel meter. The tracer tests were conducted in two phases. In the first phase, a steady-state groundwater flow condition was established by maintaining the hydraulic heads at the upstream and downstream reservoirs and by injecting water into the injection well with the designed rate. In the second phase, tracer was injected instead of water for 5 minutes, and then water was injected again to maintain water flow condition. Figure 6.3-5 shows the time trend of chloride concentration of collected water samples during the experiment. The obtained breakthrough curves were similar to the normal distribution curve, although the breakthrough curve from the third screened well (SW-3) showed double peaks. For SW-3, the first peak of the chloride concentration was analyzed to estimate the linear velocity and dispersion coefficient. The highest linear velocity was 5.5×10^{-6} m/sec at SW-3 and the largest dispersion coefficient was 2.8×10^{-4} m²/sec at SW-1. At the fourth (SW-4) and fifth (SW-5) screened wells, it was difficult to identify the breakthrough curve. Figure 6.3-5 also shows that the SP signals measured during the experiment responded to the trace injected and detected the solute transport at SW-1, SW-2 and SW-3. At SW-1, the chloride concentration showed one peak at 180 to 200 minutes, and during that time SP signals also showed the reverse effect. Similarly, at other screened wells, the SP signals also changed when the chloride concentration changed. Thus, the experimental results of the sandbox testing confirmed a relationship between the SP and measured concentrations, indicating the solute plume movement; however, further testing is needed to confirm these preliminary results.

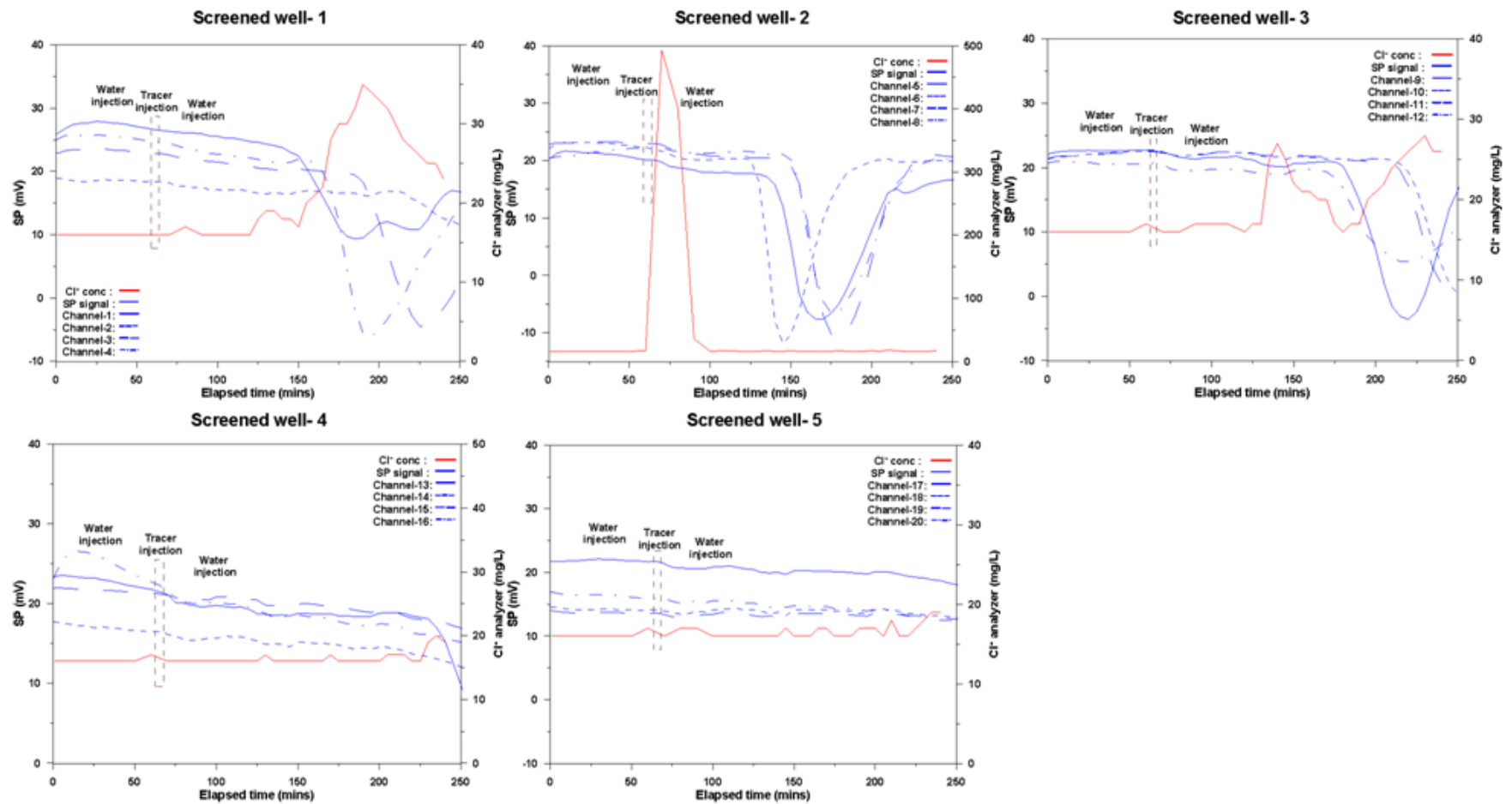

Figure 6.3-5 Measured SP signals and Cl⁻ concentrations during the sandbox tracer experiment. Black dotted boxes indicate timing of tracer injection (Wang et al. 2016).

6.3.2. Collaboration with COSC Project in Sweden on Deep Borehole Disposal

During FY16, LBNL scientists conducted research studies to support the UFD Deep Borehole Field Test effort, including a productive collaboration with members of the science team of the “Collisional Orogeny in the Scandinavian Caledonides” (COSC) project. The primary objective of the deep drilling project is to get a better understanding of some key issues of regarding the characterization of basement rocks intersected by a deep borehole through the application of geophysical surveys and downhole logging, lithologic descriptions of core, and structural studies (deformation, stress measurements, fracture orientations), as well as hydrological, geothermal, microbiologic, and geochemical measurements. One deep boreholes (2.5 km depth) was drilled into crystalline rock in central Sweden in 2014 and another will be drilled in 2017. Core was collected from the first borehole COSC-1 with over 99% core recovery. In FY15, LBNL scientists started collaborating with the COSC project as part of the UFD campaign’s deep borehole activity. This is to take advantage of the data and experiences in drilling and testing in the first 2.5-Km COSC-1 borehole that was completed in August 2014. In the drilling of COSC-1, the Swedish scientists kept a good record of (1) drilling experience with more than 99% core recovery; (2) pre-drilling and post-drilling seismic and other geophysical surveys, (3) borehole geophysical logs, (4) core handling procedure and immediate on-site measurement on recovered cores, (5) systematic XRF measurement on all cores at 10 cm intervals for key chemical compositions, and (6) downhole SGR logging to determine U, Th and K content all along the borehole.

COSC has provided a leveraged opportunity for DOE to test deep borehole characterization techniques that could be used for the planned UFD deep borehole, in particular an advanced hydrologic logging using a method called the flowing fluid electrical conductivity (FFEC) log that was developed at LBNL (Figure 6.3-6). The method is based on the evaluation of contrasts in wellbore and formation fluid salinities to identify permeable inflow zones in a wellbore (Tsang and Doughty 2003). To run the test, the borehole is first flushed with a low salinity fluid, then hydraulic head is lowered by pumping to induce inward fluid flow from the formation along permeable fractures, and finally a conductivity log is run into the borehole to detect zones with increased conductivity. Figure 6.3-6 illustrates the idea of the FFEC logging to identify locations of hydraulically active zones at a decimeter (10-cm) resolution.

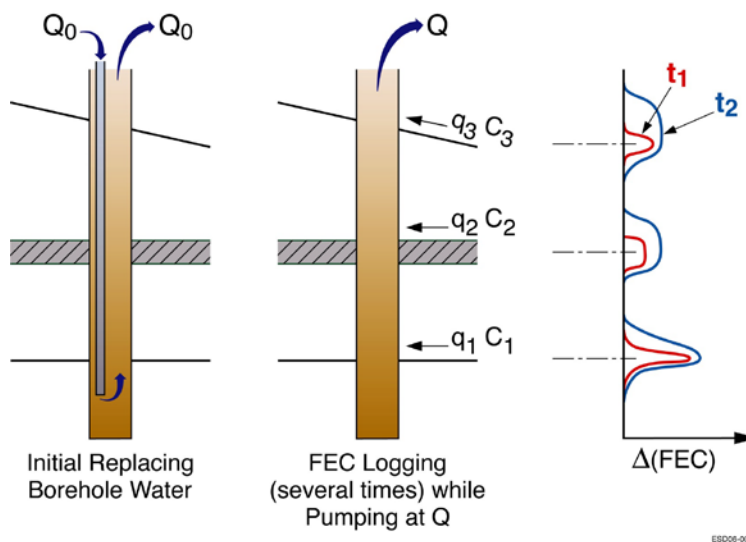

Figure 6.3-6 Schematic for FFEC logging method. Q is pump flow rate, $\Delta(\text{FEC})$ is change in electrical conductivity, q is inflow rate and C is salinity of the formation water (Dobson et al. 2016).

In the summer of 2014 during the drilling period, COSC conducted two preliminary FFEC logging tests (Tests 1 and 2), which were able to identify five hydraulically conductive zones along the borehole depth from 300 m to 2500 m. In FY15, under the COSC collaboration, LBNL studied and analyzed Tests 1 and 2 as a case study, with the goal to develop a better understanding of what information can be obtained from core and borehole measurements and what is the deep subsurface environment in granitic rocks in the context of nuclear waste disposal (Birkholzer 2015). In FY16, LBNL and COSC scientists conducted a longer-term repeat FFEC logging campaign at COSC-1 to improve on the preliminary measurements (Dobson et al. 2016). With the improved logging data from Tests 3 and 4, the analysis identified seven hydraulically conductive zones, each localized over a small depth zone, suggesting that they are individual fractures. Flow rate q and salinity C of each zone were determined by fitting the FFEC profiles for Tests 1 and 2 independently with the code BORE II. Then a Multi-Rate Analysis was used to obtain the transmissivity T and hydraulic head h of the zones by combining results of the two tests, which were conducted with different drawdowns. Figure 6.3-7 shows a typical FFEC logging analysis, baseline and pumping data compared with the model analysis using BORE II. Figure 6.3-8 shows a typical test drawdown sequence for Tests 3 and 4. For Test 3, the drawdown was set at 50 m, and for Test 4 drawdown was set at 10 m. As shown in the figure, these water levels were reasonably well maintained during logging.

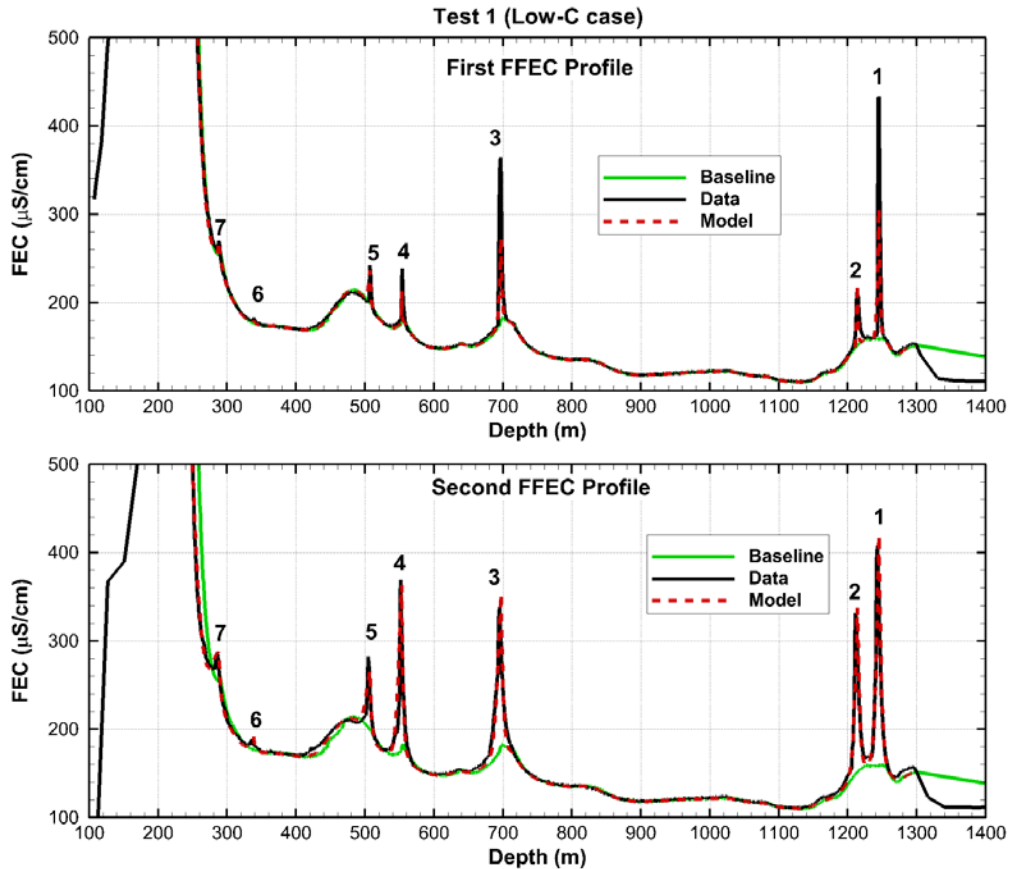

Figure 6.3-7 Comparison of the results of observations with modeling: BORE II fit to the FFEC profiles 1, using the Low- C approach (Dobson et al. 2016).

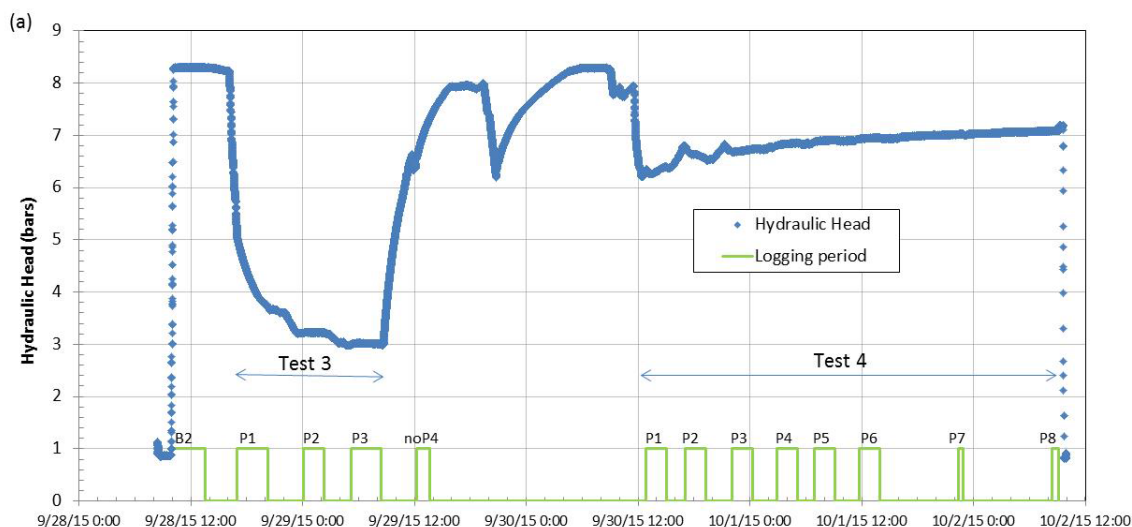

Figure 6.3-8 Test 3 and Test 4 operating conditions showing wellbore hydraulic head, with logging periods shown (Dobson et al. 2016).

The field activities were integrated with a laboratory measurements program at LBNL. LBNL obtained water samples and core samples around both flowing and non-flowing fractures. The laboratory measurements program had three parts: (i) chemical and microbiological analysis of water samples from the eight identified flow zones at COSC-1 borehole; (ii) analyses of rock matrix and fracture minerals of core samples by optical mineralogy in thin sections to determine how fracture mineralogy differs from the bulk rock and what are the differences in diagenetic alteration between hydraulically active fractures and fractures without measurable hydraulic conductivity, and (iii) measurement of fracture permeability of cores from the eight flow zones as a function of controlled stress. These laboratory permeability measurements were compared with in-situ determinations from the detailed FFEC logging. The locations of the inflow zones as identified from FFEC logging were confirmed by observations of open fractures in cores collected from these depths. Figure 6.3-9 presents photographs of two cores showing the open fractures at different depth levels.

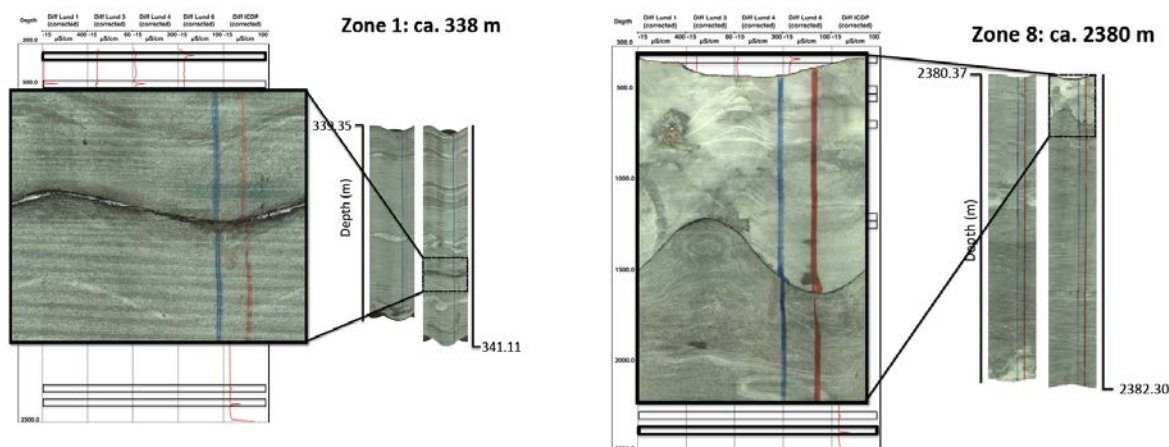

Figure 6.3-9 Core samples obtained for two of the hydraulically conductive inflow zones, showing distinct open fracture zones intersecting the borehole (Dobson et al. 2016).

Given the high value of the information that can be obtained, and the relative ease of conducting the tests, it is strongly recommend that FFEC logging during drilling be considered whenever suitable breaks in the drilling schedule occur. They can provide a wealth of information on the hydrology of the fractured rock in themselves, and offer essential guidance for designing and deploying more expensive, time-consuming characterization studies to be conducted after drilling is completed. As a further recommendation, it will be most useful to conduct a post-drilling, regular FFEC logging test lasting about one-week that includes an initial replacement of borehole water. Such a test would greatly improve the accuracy of hydrologic data obtained from the deep borehole. The experience with the FFEC logging conducted in Sweden can be very important when conducting similar field monitoring in deep borehole demonstration project currently planned in the U.S.

This page is intentionally blank.

7. BRIEF STATUS OF OTHER INTERNATIONAL COLLABORATION ACTIVITIES

This section provides brief descriptions of selected international collaboration activities that are not directly associated with access to field data or participation in URL field experiments. The focus here is on active collaboration in specific R&D projects.

7.1 Collaborative Salt Repository Research with Germany

As mentioned in Section 4.2, there are ongoing collaborative efforts between scientists from the U.S. and Germany regarding salt as a host rock for radioactive waste. These collaborative efforts focus on various topics such as thermomechanical behavior of salt, plugging and sealing, the safety case, and performance assessment, and aimed at advancing the basis for disposal of heat-generating nuclear waste in salt formations. A brief summary of the UFD funded interactions with Germany is provided in McMahon 2016. In addition to the two R&D activities focused on modeling of URL field experiments (i.e., the Asse Mine in Germany and the WIPP facility in the U.S., see Section 6.1.5), the following active collaborations were pursued in FY16:

KOSINA Project

The KOSINA project focuses on the analysis of integrity of the geological barrier for generic locations in bedded salt and salt pillows by means of geomechanical model calculations. There is no laboratory testing associated with the KOSINA project as there is in the WEIMOS project (Section 6.1.5.1), which is further developing constitutive models and simulation procedures. Partners in KOSINA include:

- BGR – Bundesanstalt für Geowissenschaften und Rohstoffe (Federal Institute for Geosciences and Natural Resources)
- DBE TEC – Deutsche Gesellschaft zum Bau und Betrieb von Endlagern für Abfallstoffe GmbH (The German Society for the construction and operation of waste repositories)
- GRS – Gesellschaft für Anlagen- und Reaktorsicherheit GmbH (Society for Plant and Reactor Safety)
- IfG – Institut für Gebirgsmechanik GmbH (Institute for Geomechanics)
- SNL – Sandia National Laboratories (Associate Partner)

In the past, bedded salt formations in Germany were not considered for HLW disposal even though bedded salt was, and still is used to host underground hazardous waste disposal facilities. Therefore, the KOSINA project was addressed in BMWi's new research concept as an important issue to improve knowledge and perform investigations that clarify conceptual questions and to contribute to the technical-scientific basis for the safety-oriented evaluation of potential repository systems in host rocks available in Germany. The topics of concern for KOSINA show good collaboration potential with the Design Concepts and Safety Analysis work packages in the DOE-Managed SNF and HLW research portfolio. Representatives from SNL visited BGR in March 2016 to conduct meetings associated with WEIMOS, KOSINA, and other topics of general interest for US/German collaboration in Salt R&D. These discussions will continue at the 7th US/German Workshop on Salt Repository Research, Design, and Operation, to be held from September 7-9 in Washington, DC.

Safety Case for Heat-Generating Waste Disposal in Salt

Subject matter experts from the US and Germany are in the process of compiling a comprehensive Features, Events, and Processes (FEPs) catalogue for disposal of heat-generating waste in salt. This collaborative effort is the primary topic of a bimonthly video conferencing between researchers from SNL and GRS (Gesellschaft für Anlagen- und Reaktorsicherheit). A face-to-face three-day workshop was held in February in Washington, DC between SNL and GRS researchers to further this effort. An associated electronic FEPs database is being created by the GRS researchers. This collaborative effort is also a key topic during periodic (generally, semi-annual) meetings of the NEA Salt Club, e.g., at the September 6, 2016 meeting to be held in conjunction with the 7th US/German Workshop on Salt Repository Research, Design, and Operation, to be held from September 7-9 in Washington, DC.

7.2 Thermodynamic Modeling and Database Development

Thermodynamic data are essential for understanding, evaluating, and modeling geochemical processes, such as speciation solubility, reaction paths, or reactive transport. The data are required to evaluate both equilibrium states and the kinetic approach to such states. However, thermodynamic databases are often limited and do not span the range of conditions that may exist under the various generic repository scenarios (salt, deep borehole, etc.). For example, previously developed thermodynamic data overstate the stabilities of smectites and illites. While this is adequate for both tuff and salt host rock, the databases have some deficiencies with respect to other repository designs, such as those in clay/shale, or those that include a clay/bentonite buffer. Data that continue to come out of the NEA thermochemical database review program were not incorporated into the previous DOE thermodynamic databases. Furthermore, NEA data are also limited and do not account for pressure extrapolations applicable to deep borehole repositories. Ion exchange data and surface complexation processes are also lacking in most current thermodynamic databases.

Scientists at LLNL have collaborated with the international research community to improve thermodynamic databases and models that evaluate the stability of EBS materials and their interactions with fluids at various physicochemical conditions relevant to subsurface repository environments. The development and implementation of equilibrium thermodynamic models are intended to describe chemical and physical processes such as solubility, sorption, and diffusion. As part of this work, LLNL scientists have continued participating in the NEA Thermochemical Database (TDB) Project (Section 3.5.3). Furthermore, LLNL has revised previously developed thermodynamic databases and expanded them to cover the needs of the repository types currently under consideration by UFD (i.e., clay, granite, deep borehole). In another collaborative effort, LLNL scientists have worked with colleagues from the Helmholtz Zentrum Dresden-Rossendorf in Germany to develop improved thermodynamic data for high-ionic-strength conditions and surface-complexation models. Progress made in FY16 on these tasks is documented in the Milestone Report M4FT-16LL080302052 “*Update to Thermodynamic Database Development and Sorption Database Integration*,” which was conducted at LLNL within the Argillite Disposal R&D Work Package Number FT-16LL08030205 (Zavarin et al. 2016). The focus of this research was on (1) the thermodynamic modeling of Engineered Barrier System (EBS) materials and properties, and (2) the development of thermodynamic databases and models to evaluate the stability of EBS materials and their interactions with fluids at various physico-chemical conditions relevant to subsurface repository environments.

7.2.1 Thermochemical Database Project

On behalf of DOE, Cynthia Atkins-Duffin of LLNL participates in the Nuclear Energy Agency (NEA) Thermochemical Database (TDB) project (Section 3.5.3). The TDB Project is a collaboration of the United States with Belgium, Canada, Czech Republic, Finland, France, Germany, Japan, Spain, Sweden,

Switzerland, and United Kingdom. Dr. Atkins-Duffin is the UFD representative for thermodynamic database development efforts at the NEA in support of international nuclear waste repository research.

The principal product of the TDB project is to make available a comprehensive, internally consistent, quality-assured and internationally recognized chemical thermodynamic database of selected chemical elements in order to meet the specialized modeling requirements for safety assessments of radioactive waste disposal systems. The objective of the TDB Project is to produce a database that:

- Contains data for all the elements of interest in radioactive waste disposal systems;
- Documents why and how the data were selected;
- Gives recommendations based on original experimental data, rather than compilations and estimates;
- Documents the sources of experimental data used;
- Is internally consistent;
- Treats all solids and aqueous species in the elements of interest for nuclear waste storage performance assessment calculations.

The Project is currently in the fifth phase (2014-2018) of activities, which include:

- Completion of the review of ancillary data (commonly used data required for use in calculations by all authors in reviews)
- Completion of second volume of iron data (thermochemical data of Iron is extensive. The review of Iron data was divided into two volumes. The first volume was completed in the fourth phase of the TDB.)
- Completion of the review of molybdenum data.
- Initiate and complete an update of the actinide data review.
- Initiate and complete a State-of-the-Art review of cement chemistry and suggest options for including these findings in safety case efforts.
- Initiate and complete a State-of-the-Art review of high ionic strength thermochemical data and suggest options for including these findings in safety case efforts.

7.2.2 Surface Complexation and Ion Exchange Database Development

LLNL researchers are also involved in international efforts to develop better surface complexation and cation exchange databases for use in PA models (Zavarin et al. 2016). This effort is a continuation of FY15 work, in collaboration with Dr. V. Brendler of the Institute of Resource Ecology at Helmholtz-Zentrum-Dresden-Rossendorf (HZDR) and the RES³T database development team. The goal of this effort is to develop a path forward for future sorption database development. The effort builds upon the RES³T database effort by assembling digitized data collected from references contained in RES³T and providing a modeling framework for fitting the digitized data to a self-consistent surface complexation model and associated database.

The RES³T project is a recent effort by HZDR to develop a digital open source thermodynamic sorption database. It includes mineral-specific surface complexation constants that can be used in additive models of more complex solid phases such as rocks or soils. It includes an integrated user interface to access selected mineral and sorption data and export data into formats suitable for other modeling software. Data records comprise mineral properties, specific surface areas, characteristics of surface binding sites and their protolysis constants, sorption ligand information, and surface complexation reactions (SC models include the Non-Electrostatic, Diffuse Double Layer, Constant Capacitance, Triple Layer, Basic Stern, and the 1-pK Model as extended to CD-MUSIC). The database also includes a comprehensive list of

publications that are the primary sources of the surface complexation data. In total, the database includes over 130 minerals, 5000 surface complexation reaction constants, and 2800 references. The database provides a comprehensive list of reaction constants reported in the literature for a very large number of radionuclide-mineral reaction pairs. However, this database project does not provide recommended values. It also does not capture the primary sorption data or provide information on the aqueous speciation constants used in determining those surface complexation constants. As a result, the RES³T project provides a foundation for developing a comprehensive surface complexation database but does not go so far as to provide one.

Three key limitations of the application of the RES³T database in performance assessment and other radionuclide transport/risk assessment models are as follows:

- An inability to integrate disparate data sets and surface complexation model constructs into single unified model and associated set of reaction constants
- An inability to produce self-consistent reaction constants based on a common set of aqueous speciation constants and surface properties.
- The absence of error propagation in the sorption data and/or database constants needed to assess model uncertainties.

To address these limitations, the inclusion of primary sorption data in the RES³T database (Dresden-Rosendorf 2013) is needed. This would allow for integration of all available literature data, error propagation, and database updating and ensure self-consistency between aqueous speciation, mineral solubility, and surface complexation databases. In FY16, the LLNL scientists continued the development of the promising approach identified in FY15, which is based on the application of recently released PhreeqC and PhreeqCRM modules (Charlton and Parkhurst 2011; Parkhurst and Wissmeier 2015). This approach was developed to facilitate operator splitting-techniques to reactive transport modeling, which could provide a comprehensive framework for testing various surface complexation models on large sets of sorption data. This new approach was tested in FY16 on a small set of U(VI)-quartz sorption data. For the test-case, only one U(VI)-quartz dataset was used (Arnold et al. 2000), using the reference formatting in RES³T; the code PhreeqC rather than PhreeqCRM was used in this case. A general description of the code is given in the report by Zavarin et al. (2016). The approach developed in FY16 can provide a robust path forward for the development of the surface complexation modeling databases that can

- Provide self-consistent fitted reaction constants based on large assemblies of data available in the literature.
- Account for data uncertainty and goodness-of-fit to the overall uncertainty in model parameters.
- Allow for updating the fitted surface complexation reaction constants as thermodynamic speciation and solubility databases evolve.
- Provide a platform for testing various surface complexation models and assess their ability to capture observed sorption data reported in the literature in a comprehensive manner.

7.3 Repository Metadata Project (RepMet)

SNL researchers have been participating in the NEA sponsored project RepMet for the last few years, and Kevin McMahon from SNL was recently elected Vice Chair of the project (the chair is from the NDA in the UK). The project involves over 10 different countries and the objective is to create a metadata registry that can be used by national programs to manage their repository data and records in a way that is harmonized internationally and is suitable for long-term management. Over these few years, the international team has created conceptual data models for waste-package, HLW/SNF repository (currently in development) and geoscience (also currently in development). The real benefit of the project is to

eventually supply those countries without RWM programs the metadata registry as a starting point. The benefit to the US (and DOE) is that expertise in this country is sought and utilized in the development of these models.

7.4 Data Exchange on Bentonite Properties with KAERI

In FY16, KAERI and SNL initiated a technical data exchange regarding the THM properties and specifications of potential bentonite buffer materials. KAERI has characterized their domestic Ca-bentonite in order to use it as a buffer material for the geological disposal system, and has provided this information to the U.S. program for consideration and data exchange. The buffer material considered in Korea is the Gyeongju bentonite, which is mostly a Ca-type bentonite. The Gyeongju bentonite consists of 70wt.% montmorillonite, 29wt.% feldspar, and about 1wt.% quartz. The bentonite mostly consists of SiO_2 and Al_2O_3 . The amount of CaO in the bentonite is greater than that of Na_2O . The cation exchange capacity (CEC) of the buffer is 57.6 meq/100 g. The specific gravity and surface area are 2.74 and 347.6 m^2/g , respectively. In addition, the liquid limit, plastic limit, and plasticity index of the buffer are 244.5%, 46.1% and 198.4%, respectively. KAERI has determined a range of thermal, hydraulic, and mechanical properties of the Ca-bentonite, such as thermal conductivity as a function of moisture content and dry density, hydraulic conductivity, diffusion coefficient, swelling pressure, uniaxial compressive strength, elastic modulus, and Poisson's ratio, etc. (Wang et al. 2016).

Page

8. SUMMARY

This report describes the status of international collaboration regarding geologic disposal research in the Used Fuel Disposition (UFD) Campaign. Since 2012, in an effort coordinated by Lawrence Berkeley National Laboratory, UFD has advanced active collaboration with several international geologic disposal programs in Europe and Asia. The joint research activities with these international programs, initiatives, or projects are very beneficial to UFD's disposal research program, providing access to the decades of experience that some international programs have gained in various disposal options and geologic environments.

The first part of this report provides an in-depth overview of the various opportunities for active international collaboration available to UFD researchers, with focus on those opportunities that involve field experiments in international URLs. Section 3 contains a summary of currently existing international opportunities resulting from DOE's formal "membership" in international collaborative initiatives, such as the DECOVALEX Project, the Mont Terri Project, the Colloid Formations and Migration Project (official membership ended December 2015), the FEBEX-DP Project, the SKB Task Force, the NEA Salt Club, and the NEA Thermochemical Database Projects. Benefits of DOE participation include (1) access to a deep knowledge base with regards to alternative repository environments developed over decades, (2) access to experimental data from many past, ongoing, and future *in situ* tests conducted in several URLs in different host rocks, (3) active research participation in international groups that conduct, analyze, and model performance-relevant processes, and (4) the opportunity to conduct own experiments in international URLs. Additional cooperation possibilities are discussed in Section 4; these comprise bilateral collaborations options with international disposal programs.

Within the past few years, UFD disposal research program has made very good use of these international collaboration opportunities. A balanced portfolio of international R&D activities was developed, addressing relevant R&D challenges in fields like near-field perturbation, engineered barrier integrity, RN transport, integrated system behavior, and method development for characterization and monitoring. These activities now form a considerable portion of UFD disposal research, in particular in the Crystalline and Argillite work packages. The second part of this report provides an overview of this collaborative R&D portfolio and explains how UFD scientists benefit from collaboration with international peers. Section 5 describes the planning process that forms the basis for the selection and continued reevaluation of specific activities. Section 6 then gives a detailed description of selected projects that make use of international field experiments, and Section 7 briefly mentions other active cooperation projects.

Overall, this report attests to the fact that DOE/UFD has in a very short time frame developed valuable international research collaborations that have already led to substantial technical advances. The joint R&D with international researchers and the access to relevant data for field and laboratory experiments and modeling from a variety of URLs and host rocks have helped UFD researchers to significantly improve their understanding of the current technical basis for disposal in a range of potential host-rock environments. UFD scientists have utilized data and results from laboratory and field studies that have been and are being conducted with millions of R&D investments provided by international partners. The UFD advanced simulation models have been verified and validated against these experimental studies, providing a robust modeling and experimental basis for the prediction of the complex processes defining the performance of a multi-barrier waste repository system. Comparison of UFD model results with other international modeling groups, using their own simulation tools and conceptual understanding, has enhanced confidence in the robustness of predictive models used for performance assessment. In addition, the possibility of linking model differences to particular choices in conceptual model setup has provided

valuable guidance into “best” modeling choices and understanding the effect of conceptual model variability.

Over the years, as research priorities change and new opportunities for collaboration develop, UFD’s international research portfolio has evolved and will continue to evolve. In FY15 and FY16, UFD made a targeted effort to reassess its international collaboration activities, in a process similar to the initial selection process conducted in previous years. Two planning sessions were held in conjunction with the recent UFD Working Group Meetings in Las Vegas on June 9–11, 2015 and June 7-9, 2016. These sessions were to review existing and emerging opportunities for international collaboration, evaluate their technical merit and cost/benefit ratio, align these opportunities with the current and planned work scope within UFD work packages for possible leveraging, and develop a revised portfolio of international R&D activities that align with goals, priorities, and funded plans of the UFD program. For example, because of this evaluation process, UFD decided in FY15 to end its participation in the CFM Project because of its relatively narrow focus and relatively high participatory cost. Meanwhile, promising opportunities exist for further expansion of the international program.

In the future, UFD will also evaluate whether its international collaboration focus should move from a mostly participatory role in ongoing *in situ* experiments conducted by other nations, to a more active role in developing or co-developing its own experimental program in international URLs. Some collaborative initiatives like the Mont Terri Project provide their partner organizations with the opportunity of conducting their own experimental work and inviting other partners to join. This option would allow the U.S. disposal program to perform *in situ* fieldwork in representative host rocks (e.g., clay, crystalline, salt), even though there are currently no operating underground research laboratories in the U.S.

9. ACKNOWLEDGMENTS

Funding for this work was provided by the Used Fuel Disposition Campaign, Office of Nuclear Energy, of the U.S. Department of Energy under Contract Number DE-AC02-05CH11231 with Lawrence Berkeley National Laboratory. The authors are grateful to the various international collaboration partners for many fruitful interactions and collaborations. The joint R&D with international researchers and the access to relevant data/experiments from a variety of URLs and host rocks have helped UFD researchers to significantly improve their understanding of the current technical basis for disposal in a range of potential host-rock environments and has contributed to testing and validating predictive computational models for evaluation of disposal-system performance in a variety of generic disposal-system concepts.

This page is intentionally blank.

10. REFERENCES

- Aalto, P., I. Aaltonen, H. Ahokas, J. Andersson, M. Hakala, P. Hellä, J.A. Hudson, E. Johansson, K. Kemppainen, L. Koskinen, M. Laaksoharju, M. Lahti, S. Lindgren, A. Mustonen, K. Pedersen, P. Pitkänen, A. Poteri, M. Snellman, and M. Ylä-Mella (2009), *Programme for Repository Host Rock Characterization in ONKALO (ReRoc)*, Posiva Oy Working Report 2009-31.
- Äikäs, T. (2011), *Towards Implementation*, Presentation given at the HADES Workshop, “30 Years of Underground Research Laboratory,” May 23-25, 2011, Antwerp, Belgium.
- Alonso, E.E., J. Vaunat and A. Gens (1999), Modeling the mechanical behaviour of expansive clays. *Engineering Geology* 54: 173-183.
- Alonso, E.E., A. Gens, and A. Josa (1990), A Constitutive Model for Partially Saturated Soils, *Géotechnique*, 40(3), 405-430.
- Alt-Epping, P., C. Tournassat, P. Rasouli, C.I. Steefel, K.U. Mayer, A. Jenni, U. Mäder, S.S. Sengor, and R. Fernández, (2015), Benchmark reactive transport simulations of a column experiment in compacted bentonite with multispecies diffusion and explicit treatment of electrostatic effects: *Computational Geosciences*, v. 19, no. 3, p. 535-550.
- Argüello, J.G. (2015), Summary of FY15 Results of Benchmark Modeling Activities. Tech. rept. SAND2015-6273. Sandia National Laboratories.
- Argüello, J.G. and J.F. Holland (2015), Revisiting the 1980’s WIPP Room D and B In-Situ Experiments: Performing Thermo-Mechanical Simulations of Rock Salt Using a State-of-the-Art Code Suite. In: 47th US Rock Mechanics/Geomechanics Symposium. American Rock Mechanics Association.
- Arnold, T., Zorn, T., Bernhard, G., and Nitsche, H., (2000), Applying the DDLM to model the sorption of uranium onto quartz and muscovite Annual report 1999, Forschungszentrum Rossendorf e.V. Institute of Radiochemistry, Dresden, Germany.
- Barnichon, J.D. (2011), *IRSN proposal - the SEALEX In Situ Tests*, Presentation given at 7th DECOVALEX 2011 Workshop, April 2011, Helsinki, Finland.
- Barnichon, J.D., and A. Millard (2012), *Task A: the SEALEX In Situ Experiments*, Presentation given at 1st DECOVALEX 2015 Workshop, April 2012, Berkeley, CA.
- Bechthold, W., E. Smailos, S. Heusermann, W. Bollingerfehr, B. Bazargan-Sabet, T. Rothfuchs, P. Kamlot, J. Grupa, S. Olivella, and F.D. Hansen. (2004), Backfilling and Sealing of Underground Repositories for Radioactive Waste in Salt (BAMBUS-II Project). Final Report EUR 20621 EN. Luxembourg: Office for Official Publications of the European Community. ERMS 534716.
- Birgersson, M. (2011), EBS-TFC: Experimental overview of benchmarks 1 – 4, Clay Technology AB, SKB EBS Task Force Internal Document: Sweden, SKB (Swedish Nuclear Fuel and Waste Management Company), p. 13.
- Birgersson, M., L. Börgesson, M. Hedström, O. Karnland, and U. Nilsson (2009), Bentonite erosion - Final report (TR-09-34), Clay Technology AB: Sweden, SKB (Swedish Nuclear Fuel and Waste Management Company), p. 164.
- Birkholzer, J.T. (2011), *Disposal R&D in the Used Fuel Disposition Campaign: A Discussion of Opportunities for Active International Collaboration*, Prepared for U.S. Department of Energy Used Fuel Disposition Campaign, FCRD-USED-2011-000225, Lawrence Berkeley National Laboratory.

- Birkholzer, J.T. (2012), *Status of UFD Campaign International Activities in Disposal Research*, Prepared for U.S. Department of Energy Used Fuel Disposition Campaign, FCRD-UFD-2012-000295, Lawrence Berkeley National Laboratory.
- Birkholzer, J.T. (2014), *International Collaboration Activities in Different Geologic Disposal Environments*, Prepared for U.S. Department of Energy Used Fuel Disposition Campaign, FCRD-UFD-2015-0000679, Lawrence Berkeley National Laboratory.
- Birkholzer, J.T. (2015), *International Collaboration Activities in Different Geologic Disposal Environments*, Prepared for U.S. Department of Energy Used Fuel Disposition Campaign, FCRD-UFD-2014-000065, Lawrence Berkeley National Laboratory.
- BMWi (2008), *Final Disposal of High-level Radioactive Waste in Germany – The Gorleben Repository Project*, Federal Ministry of Economics and Technology (BMWi), Germany, October, 2008.
- Blanco-Martín, L., Wolters R., Rutqvist J., Lux K.-H., Birkholzer J.T. (2016), Thermal–hydraulic–mechanical modeling of a large-scale heater test to investigate rock salt and crushed salt behavior under repository conditions for heat-generating nuclear waste. *Computers and Geotechnics*, 77, 120–133.
- Bockgård, N., P. Vidstrand, M. Åkesson (2012), *Task 8, Modeling the interaction between engineered and natural barriers - An assessment of a fractured bedrock description in the wetting process of bentonite at deposition tunnel scale*, Task Description for GWFTS Task Force, SKB, Internal Report.
- Bolton, A.J., M.B. Clennell, and A.J. Maltman (1999), Nonlinear stress dependence of permeability: A mechanism for episodic fluid flow in accretionary wedges, *Geology*, 27(3), 323-334.
- Bond, A. (2016), DECOVALEX-2015 Project, Task C1 Final Report, Published by KTH, ISBN 978-91-7595-829-3(06), May 2016.
- Bond, A., J.T. Birkholzer (2016), DECOVALEX 2019 Project – Summary Task Description, January 2016.
- Börgesson, L., A. Dueck, and R. Goudarzi (2015), *EBS TF Assignment For Phase 2 Homogenisation Task 2, Self-Healing Test (DRAFT)*: Sweden, SKB (Swedish Nuclear Fuel and Waste Management Company), p. 10.
- Bossart, P., and M. Thury (2007), *Research in the Mont Terri Rock laboratory: Quo vadis? Physics and Chemistry of the Earth, Parts A/B/C*, 32(1-7), 19-31.
- Bossart, P. (2012), *Welcome to Technical Meeting 8-9 February 2012*, Presentation given at the Mont Terri Technical Meeting TM-30, February 8-9, 2012, Saint Ursanne, Switzerland.
- Bossart, P. (2014a), *Enclosure – Steering Meeting SM-64*, Presentation given at the Mont Terri Steering Meeting SM-64, March 27, 2014, Tournemire URL, France.
- Bossart, P. (2014b), *Enclosure – Steering Meeting SM-654*, Presentation given at the Mont Terri Steering Meeting SM-65, May 15, 2014, Horonobe, Japan.
- Bossart, P. (2015), *Welcome to Technical Meeting 11-12 February 2015*, Presentation given at the Mont Terri Technical Meeting TM-33, February 11-12, 2015, Porrentruy, Switzerland.
- Bossart, P. (2016), *Minutes of the 71th Steering Committee Meeting of the Mont Terri Project*, May 19, 2016, St. Ursanne, Switzerland.

- Bossart, P., and various others (2016), Geologic Setting and Overview of Key Experiments in the Mont-Terri Rock Laboratory, accepted for publication in Swiss Journal of Geosciences.
- Bragg-Sitton, S.M, J.T. Birkholzer, R. MacKinnon, K. McMahon, S. Saltzstein, K., Sorenson, and P. Swift (2014), *Update of the Used Fuel Disposition Campaign Implementation Plan*, Prepared for U.S. Department of Energy Used Fuel Disposition Campaign, FCRD-UFD-2014-000047.
- Charlton, S. R. and Parkhurst, D. L., (2011). Modules based on the geochemical model PHREEQC for use in scripting and programming languages. *Computers & Geosciences* 37, 1653-1663.
- Cheshire, M., F.A. Caporuscio, M.S. Rearick, C.F. Jové Colón, and M.K. McCarney (2014), Bentonite evolution at elevated pressures and temperatures: An experimental study for generic nuclear repository designs: *American Mineralogist*, 99, 1662-1675.
- Daucousse. D. and Lloret ,A. (2003), Results of “in situ” measurements of water content and dry density, Technical report, Polytechnic University of Catalonia, 70-UPC-L-5-012.
- Dobson et al. (2016), Deep Borehole Field Test Research Activities at LBNL, Deep Borehole Field Test – LBNL FT-16LB08030803.
- Dresden-Rossendorf, H.-Z., (2013), RES³T - Rossendorf Expert System for Surface and Sorption Thermodynamics. RES³T - Rossendorf Expert System for Surface and Sorption Thermodynamics, Dresden, Germany.
- ENRESA (2000), Full-scale engineered barriers experiment for a deep geological repository in crystalline host rock FEBEX Project, European Commission: 403.
- Fernández, A. M., B. Baeyens, M. Bradbury and P. Rivas (2004), Analysis of the porewater chemical composition of a Spanish compacted bentonite used in an engineered barrier. *Physics and Chemistry of the Earth, Parts A/B/C* 29(1): 105-118.
- Garcia-Sineriz, J.L., Abós, H., Martínez, V., De la Rosa, C., Mäder, U. and Kober, F. (2016), *FEBEX-DP Dismantling of the heater 2 at the FEBEX "in situ" test*. Nagra Arbeitsbericht NAB 16-011. p. 92.
- Garitte, B. (2010), *New In Situ Experiments at Mont Terri*, Presentation given at 6th DECOVALEX 2011 Workshop, October 2010, Wuhan, China.
- Garitte, B. and several others (2011), *HE-E experiment - In Situ Heater Test*, Presentation given at 7th DECOVALEX 2011 Workshop, April 2011, Helsinki, Finland.
- Garitte, B. (2016), DECOVALEX-2015 Project, Task B1 Final Report, Published by KTH, ISBN 978-91-7595-827-9(04), May 2016.
- Garitte, B., and A. Gens (2012), *DECOVALEX-2015: Description of Task B1, THM Processes in Argillaceous Rocks and the Engineered Barrier*, DECOVALEX Task Description Report, Modeling Step 1, August 2012.
- Gaus, I., and Kober, F. (2014), *FEBEX-DP Project Plan*, NAGRA, Switzerland.
- Gaus, I., B. Garitte, R. Senger, A. Gens, R., Vasconcelos, J.-L. Garcia-Sineriz, T. Trick, K. Wiczorek, O. Czaikowski, K. Schuster, J.C. Mayor, M. Velasco, U. Kuhlmann, and M.V. Villar (2014), *The HE-E Experiment– Layout, Interpretation, and THM Modeling*, NAGRA Arbeitsbericht NAB 14-53, May 2014, Switzerland.

- Gens A., M. Sánchez, and D. Sheng, D (2006), On constitutive modelling of unsaturated soils. *Acta Geotechnica. 1*, 137-147
- Gens, A. (2016), DECOVALEX 2019, Task D: HM and THM Interactions in Bentonite Engineered Barriers (INBEB), Task Specification Document for DECOVALEX Project, 59 pp., 2016.
- Graupner, B., Rutqvist, J., Guglielmi, Y. (2016), DECOVALEX 2019, Description of DECOVALEX Task B, Fault Slip Test – Modelling of the Induced Slip of a Fault in Argillaceous Rock, 14 pp., 2016.
- Guglielmi, Y., F. Cappa, H. Lançon, J.B. Janowczyk, J. Rutqvist, C.F. Tsang, and J. Wang (2013a), Estimation of permeability, elastic and friction properties of fractured rock masses from in situ hydromechanical testing: the High- frequency Pulse Poroelasticity Protocole (HPPP) testing method. Submitted contribution to the ISRM Commission on Testing Methods, *Int J Rock Mech Min Sci and Geomech Abstr* special issue.
- Guglielmi, Y., P. Henry, F. Cappa, and B. Derode (2013b), *Relationships between slow slip, seismicity and fluid leakage during a pressurized fault zone rupture in situ experiment: Importance for reservoir/caprock stimulation monitoring and efficiency assessment*. ARMA Symposium Paper N°13-517, ARMA San Francisco 23-26 June 2013.
- Guglielmi, Y., P. Henry, C. Nussbaum, P. Dick, C. Gout, and F. Amann (2015), Underground Research Laboratories for conducting fault activation experiments in shales. ARMA Symposium Paper N°15-480, ARMA San Francisco June 2015.
- Guglielmi, Y. (2016), In Situ Clay Fault Slip Hydro-mechanical Characterization (FS Experiment), Mont Terri Underground Rock Laboratory, Mont Terri Project Technical Note 2015-60 63 pp., 2016.
- Guglielmi, Y., J.T. Birkholzer, J. Rutqvist, P. Jeanne, C. Nussbaum (2016), *Can Fault Leakage Occur Before or Without Fault Activation? Results from an In Situ Fault Reactivation Experiment at Mont Terri*. 13th International Conference on Greenhouse Gas Control Technologies, Lausanne, Switzerland, November 2016.
- Hansen, F., C.W. Leigh, W. Steininger, W. Bollingerfehr, and T. von Berlepsch (2015), *Proceedings of the 5th US/German Workshop on Salt Repository Research, Design and Operation*. FCRD-UFRD-2015-00514, SAND2015-0500R. U.S. Department of Energy, Office of Nuclear Energy, Used Fuel Disposition Campaign, Washington, D.C.
- Hansen, F., W. Steininger, and E. Biurrun (2013), *Proceedings of the 4th US/German Workshop on Salt Repository Research, Design and Operation*. FCRD-UFD-2014-000335, SAND2013-10592P. U.S. Department of Energy, Office of Nuclear Energy, Used Fuel Disposition Campaign, Washington, D.C.
- Hardin, E., C. Bryan, A. Ilgen, E. Kalinina, S. Teich-Goldrick, K. Banerjee, J. Clarity, R. Howard, R. Jubin, J. Scaglione, F. Perry, L. Zheng, J. Rutqvist, J.T. Birkholzer, H. Greenberg, J. Carter, and T. Severynse (2014), *Investigation of Dual-Purpose Canister Direct Disposal Feasibility*, Prepared for U.S. Department of Energy Used Fuel Disposition Campaign, FCRD-UFD-2014-000069 REV 1, Sandia Laboratories.
- Harrington, J., R. Cuss, C. Graham, and S. Norris (2015), *Advective Gas Flow in Bentonite*, Presentation given at 7th DECOVALEX 2015 Workshop, April 2015, Brno, Czech Republic.

- Harrington, J. (2016), DECOVALEX 2019, Specification for DECOVALEX-2019: Task A: modElliNg Gas INjection ExpERiments (ENGINEER), 16 pp., 2016.
- Hofmanová, E., and R. Červinka, (2014), Benchmark 5 – Diffusion of selected anions through compacted bentonite, SKB EBS Task Force Internal Documentation, p. 7.
- Hokr, M. and J. Slovak (2011), *Bedrichov Tunnel Test Case Proposal for DECOVALEX 2015*, Presentation given at 7th DECOVALEX 2011 Workshop, April 2011, Helsinki, Finland.
- Hokr, M., A. Balvín, I. Škarydová, and P. Rálek (2014), *Tunnel inflow in granite - fitting the field observations with hybrid model of discrete fractures and continuum*, in (Sharp and Troeger, eds) *Groundwater in Fractured Rocks*, 13 pages, to appear 2014
- Hokr, M., A. Balvin, H. Shao, H. Kunz, W.P. Gardner, Y. Wang (2016), DECOVALEX-2015 Project, Task C2 Final Report, Published by KTH, ISBN 978-91-7595-830-9(07), May 2016.
- Huertas, F.B., de la Cruz, J.L. Fuentes-Cantillana, et al. (2005). *Full-Scale Engineered Barriers Experiment for a Deep Geological Repository for High-Level Waste in Crystalline Host Rock – Phase II*. EUR 21922.
- Itasca (2009) *FLAC3D V4.0, Fast Lagrangian Analysis of Continua in 3 Dimensions, User's Guide*, Itasca Consulting Group, Minneapolis, Minnesota.
- Iwatsuki, T. (2016), *Task C: GREET, Hydro-mechanical-chemical-biological Processes During Groundwater Recovery*, Presentation given at 1st DECOVALEX 2019 Workshop, May 2016, Berkeley, USA.
- Jing, L. and J.A. Hudson (2011), *Technical Descriptions of the Three Tasks Proposed for the Next Phase of the DECOVALEX Project (2012–2015)*, Internal DECOVALEX Report, December 15, 2011.
- Jing, L., J.A. Hudson, J.T. Birkholzer. (2016), DECOVALEX-2015 Project, Executive Summary, Published by KTH, ISBN 978-91-7595-825-5(02), May 2016.
- Jove-Colon, C.F., F.A. Caporuscio, S.S. Levy, H. Xu, J.A. Blink, W.G. Halsey, T. Buscheck, M. Sutton, M.A. Serrano de Caro, T.J. Wolery, H.-H. Liu, J.T. Birkholzer, C.I. Steefel, J. Rutqvist, C.-F. Tsang, and E. Sonnenthal (2010), *Disposal Systems Evaluations and Tool Development - Engineered Barrier System (EBS) Evaluation*, Prepared for U.S. Department of Energy Used Fuel Disposition Campaign, Used Fuel Disposition Campaign.
- Jove-Colon, C. (2016), International Collaboration Activities on Engineered Barrier Systems, Prepared for U.S. Department of Energy Used Fuel Disposition. FCRD-UFD-2016-000628, Prepared for U.S. Department of Energy Used Fuel Disposition Campaign, Used Fuel Disposition Campaign.
- KAERI (2011), *KURT – KAERI Underground Research Tunnel*, Brochure, Korea Atomic Energy Research Institute, Division of Radioactive Waste Technology Development.
- Kawai, T. (1978), *New Discrete Models and their Application to Seismic Response Analysis of Structures*. Nuclear Engineering and Design, 48, 207-229.
- Kober, F. (2016), *HotBENT Meeting, 04, May 2016, Kartause Ittingen, CH*. NAGRA, Aktennotiz AN 16-443.

- Lanaro, F. (2016), *DECOVALEX-2019 Task G – EDZ Evolution, Reliability, Feasibility and Significance of Measurements of Conductivity and Transmissivity of the Rock Mass for the Understanding of the Evolution of a Repository of Spent Nuclear Fuel*, Presentation given at 1st DECOVALEX 2019 Workshop, May 2016, Berkeley, USA.
- Lanyon, G.W., Marschall, P., Trick, T., de La Vaissière, R., Shao, H., Leung, H. (2009), *Hydro-mechanical Evolution and Self-Sealing of Damage Zones around a Microtunnel in a Claystone Formation of the Swiss Jura Mountains*. American Rock Mechanics Association, ARMA 09-333.
- Lanyon, W. et al. (2013), *Review of the FEBEX in situ experiment and the mock-up after 15 years of operation and monitoring*. NAGRA NAB 13-096.
- Lebon, P. (2011) *Large-scale Experiment at Bure*, Presentation given at the HADES Workshop, “30 Years of Underground Research Laboratory,” May 23-25, 2011, Antwerp, Belgium.
- Li, X. (2011), *Design and Status of the PRACLAY Seal and Heater Test*, Presentation given at the HADES Workshop, “30 Years of Underground Research Laboratory,” May 23-25, 2011, Antwerp, Belgium.
- Liu, H.H., Houseworth, J., Rutqvist, J., Zheng, L., Asahina, D., Li, L., Vilarrasa, V., Chen, F., Nakagawa, S., Finsterle, S., Doughty, C., Kneafsey, T., Birkholzer, J. (2013) Report on THMC Modeling of the Near Field Evolution of a Generic Clay Repository: Model Validation and Demonstration. Prepared for U.S. Department of Energy, Used Fuel Disposition Campaign, FCRD-UFD-2013-000244, Lawrence Berkeley National Laboratory.
- Maes, N., E. Weetjens, M. Aertsen, J. Govaerts, and L. Van Ravestyn (2011), *Added Value and Lessons Learned from In Situ Experiments – Radionuclide Migration*, Presentation given at the HADES Workshop, “30 Years of Underground Research Laboratory,” May 23-25, 2011, Antwerp, Belgium.
- Marschall, P., M. Distinguin, H. Shao, P. Bossart, C. Enachescu, and T. Trick (2006), *Creation and Evolution of Damage Zones Around a Microtunnel in a Claystone Formation of the Swiss Jura Mountains*. Society of Petroleum Engineers, SPE-98537-PP.
- Mayor, J.C. and A. Gens (2015), *HM and THM Interactions in Bentonite Engineered Barriers*, Presentation given at 7th DECOVALEX 2015 Workshop, April 2015, Brno, Czech Republic.
- McCallum, J.L., Engdahl, N.B., Ginn, T.R., Cook, P.G. (2014), Nonparametric estimation of groundwater residence time distributions: What can environmental tracer data tell us about groundwater residence time? Water Resources Research DOI 10.1002/2013WR014974.
- McGuire, T.P., Elsworth, D., Karcz, Z., (2013), Experimental measurements of stress and chemical controls on the evolution of fracture permeability. *Transp. Porous Med.*, 98, 15-34.
- McMahon, K. (2016), *Report on the Status of the UFD Campaign International Activities in Disposal Research at SNL*, Prepared for U.S. Department of Energy Used Fuel Disposition Campaign, FCRD-UFD-2016-000619, Sandia National Laboratories.
- Millard, A. and J.D. Barnichon (2014), *Task A – Step 2: Modelling of the SEALEX WT-1 test*, Presentation given at 5th DECOVALEX 2015 Workshop, April 2014, Avignon, France.
- Millard, A., N. Mokni, J.D. Barnichon (2016), DECOVALEX-2015 Project, Task A Final Report, Published by KTH, ISBN 978-91-7595-826-2(03), May 2016.

- Munson, D.E., A.F. Fossum, and P.E. Senseny. (1989). Advances in resolution of discrepancies between predicted and measured in situ WIPP room closures. Tech. rept. SAND88-2948. Sandia National Laboratories.
- Munson, D.E., K.L. DeVries and G.D. Callahan. (1990). Comparison of Calculations and In Situ Results for a Large, Heated, Test Room at the Waste Isolation Pilot Plant (WIPP). Tech. rept. SAND89-2268. Sandia National Laboratories.
- NAGRA (2010), *Grimsel Test Site – Research on Safe Geologic Disposal of Radioactive Waste*, Brochure in Recognition of 25 Years of Research at Grimsel Test Site, NAGRA, July 2010.
- NAGRA (2014), *FEBEX-DP Kick-Off Meeting*, Presentation given at the kick-off meeting for the FEBEX-DP project, Thun, Switzerland, June 2014.
- Nutt, M. (2010), *Used Fuel Disposition Campaign International Activities Implementation Plan*, Prepared for U.S. Department of Energy Used Fuel Disposition Campaign, FCRD-USED-2011-000016 REV 0, Argonne National Laboratory.
- Nutt, M. (2011), *Used Fuel Disposition Campaign Disposal Research and Development Roadmap*, Prepared for U.S. Department of Energy Used Fuel Disposition Campaign, FCRD-USED-2011-000065 REV0, Argonne National Laboratory.
- Parkhurst, D. L. and Wissmeier, L., (2015). PhreeqcRM: A reaction module for transport simulators based on the geochemical model PHREEQC. *Advances in Water Resources* 83, 176-189.
- Polak, A., Elsworth D., Yasuhara H., Grader A. S., Halleck P. M. (2003) Permeability Reduction of a Natural Fracture Under Net Dissolution by Hydrothermal Fluids, *Geophys. Res. Lett.*, 30(20), 2020.
- Posiva (2011), *Olkiluoto Site Description 2011*, Posiva Oy, Report POSIVA 2011.
- Ragoussi, M.E. and S. Brassinnes (2015), The NEA Thermochemical Database Project: 30 years of accomplishments. *Radiochimica Acta*, 2392.
- Reimus, P. (2012), *Preliminary Interpretation of a Radionuclide and Colloid Tracer Test in a Granodiorite Shear Zone at the Grimsel Test Site, Switzerland*, Prepared for U.S. Department of Energy Used Fuel Disposition Campaign.
- Reimus, P. W. and Boukhalfa, H. (2014). Chancellor Water Colloids: Characterization and Radionuclide Associated Transport, Final Report for NNSS Underground Test Area Program, LA-UR-14-27538, Los Alamos National Laboratory, Los Alamos, NM.
- Reimus, P., M. Zavarin, Y. Wang (2016), *Colloid-Facilitated Radionuclide Transport: Current State of Knowledge from a Nuclear Waste Repository Risk Assessment Perspective*, Prepared for U.S. Department of Energy Used Fuel Disposition Campaign, FCRD-UFD-2016-000446.
- Reimus, P.W., G. Pohll, T. Mihevc, J. Chapman, L. Papelis, B. Lyles, S. Kosinski, R. Niswonger, and P. Sanders (2003), Testing and Parameterizing a Conceptual Model for Radionuclide Transport in a Fractured Granite Using Multiple Tracers in a Forced-Gradient Test, *Water Resour. Res.*, 39(12), 1350, doi:10.1029/2002WR001597.
- Rejeb, A. and J. Cabrera (2006) *Time-dependent evolution of the excavation damaged zone in the argillaceous Tournemire Site (France)*, Proceedings “GeoProc 2006,” Invited lecture in the 2nd International Conference on Coupled THMC Processes in Geosystems and Engineering, May 22-25 2006, Nanjing, China, pp. 65-74.

- Rutqvist, J., L. Zheng, F. Chen, H.-H. Liu, and J.T. Birkholzer (2014a), *Modeling of Coupled Thermo-Hydro-Mechanical Processes with Links to Geochemistry Associated with Bentonite-Backfilled Repository Tunnels in Clay Formations*. Rock Mechanics and Rock Engineering, 47, 167–186.
- Rutqvist, J., J. Davis, L. Zheng, V. Vilarrasa, J. Houseworth, and J.T. Birkholzer (2014b), *Investigation of Coupled THMC Processes and Reactive Transport: FY14 Progress*. Prepared for U.S. Department of Energy, Used Fuel Disposition, FCRD-UFD-2014-000497, Lawrence Berkeley National Laboratory, LBNL-6720E.
- Rutqvist, J., Zheng L., Chen F, Liu H.-H, and Birkholzer J. (2014c), Modeling of Coupled Thermo-Hydro-Mechanical Processes with Links to Geochemistry Associated with Bentonite-Backfilled Repository Tunnels in Clay Formations. Rock Mechanics and Rock Engineering, 47, 167–186.
- Rutqvist, J. (2011), Status of the TOUGH-FLAC Simulator and Recent Applications Related to Coupled Fluid Flow and Crustal Deformations. *Computers & Geosciences*, 37, 739–750.
- Rutqvist, J., C. Steefel, F. Chen, J. Houseworth, V. Vilarrasa, H.-H. Liu, and J.T. Birkholzer (2013), *THM and Reactive Transport Model Development and Evaluation: International Activities*, Prepared for U.S. Department of Energy Used Fuel Disposition Campaign, FCRD-UFD-2013-000372, Lawrence Berkeley National Laboratory.
- Rutqvist, J., L. Blanco-Martín, S. Molins, D. Trebotich, and J.T. Birkholzer (2015), *Modeling Coupled THM Processes and Brine Migration in Salt at High Temperatures*, Prepared for U.S. Department of Energy Used Fuel Disposition Campaign, FCRD-UFD-2015-000366, Lawrence Berkeley National Laboratory, LBNL-191216.
- Rutqvist, J., Y.-S. Wu, C.-F. Tsang, G. Bodvarsson, G. (2002), A Modeling Approach for Analysis of Coupled Multiphase Fluid Flow, Heat Transfer, and Deformation in Fractured Porous Rock, *Int. J. of Rock Mechanics & Mining Sciences*, 39, 429–442.
- Samper, J., L. Zheng, L. Montenegro, A. M. Fernández and P. Rivas (2008a). Coupled thermo-hydro-chemical models of compacted bentonite after FEBEX in situ test. *Applied Geochemistry* 23(5): 1186-1201.
- Sánchez, M., A. Gens, L. do N. Guimarães, and S. Olivella (2005), A double structure generalized plasticity model for expansive materials. *Int. J. Numer. Anal. Meth. Geomech.*, 29, 751–787.
- Shao, H. (2016), *Fluid Inclusion and Movement in Tight Rock (FINITO)*, Presentation given at 1st DECOVALEX 2019 Workshop, May 2016, Berkeley, USA.
- SKB (2011a), *Äspö Hard Rock Laboratory Annual Report 2010*, SKB Technical Report TR-11-10, February 2011.
- SKB (2011b), *Äspö Hard Rock Laboratory Planning Report for 2011*, SKB International Progress Report IPR-10-19, February 2011.
- Sugita, Y. (2015), *Groundwater REcovery Experiment in Tunnel (GREET) in the MIU Project*, Presentation given at 7th DECOVALEX 2015 Workshop, April 2015, Brno, Czech Republic.
- Solomon, D.K., Genereux, D.P., Plummer, L.N., Busenberg E (2010), Testing mixing models of old and young groundwater in a tropical lowland rain forest with environmental tracers. *Water Resour Res* 46(4): W04518.

- Sugita, Y. and S. Nakama (2012), *Task B: EBS Horonobe Experiment*, Presentation given at 1st DECOVALEX 2015 Workshop, April 2012, Berkeley, CA.
- Sugita, Y., S. Kwon, C. Lee, J. Massmann, P.Z. Pan, J. Rutqvist. (2016), DECOVALEX-2015 Project, Task B2 Final Report, Published by KTH, ISBN 978-91-7595-828-6(05), May 2016.
- Tsang, C.F. and Doughty, C. (2003) Multirate flowing fluid electric conductivity logging method, *Water Resources Research* 39(12):1354-1362, doi:10.1029/2003WR002308
- Tsang, C.-F., J.D. Barnichon, J.T. Birkholzer, X.L. Li, H.-H. Liu, X. Sillen, and T. Vietor (2011), A Review of Coupled Thermo-Hydro-Mechanical Processes in the Near-field of a High-Level Radioactive Waste Repository in a Clay Formation, *International Journal of Rock Mechanics and Mining Sciences*, 49, 31-44.
- Tsang, C.-F., O. Stephansson, L. Jing, and F. Kautsky (2009), *DECOVALEX Project: from 1992 to 2007*, *Environmental Geology*, 57, 1221–1237, 2009.
- Tsang, C.F., Rosberg, J.E., Sharma, P., Berthet, T., Juhlin, C., and Niemi, A. (2016) Hydrologic testing during drilling: application of the flowing fluid electrical conductivity (FFEC) logging method to drilling of a deep borehole, *Hydrogeology Journal* 24: 1333-1341.
- UFD (2012), *Office of Used Nuclear Fuel Disposition International Program – Strategic Plan*, April 2012, U.S. Department of Energy.
- Van Marcke, P. and W. Bastiaens (2010) *Construction of the PRACLAY Experimental Gallery at the Hades URF*, Clay in Natural and Engineered Barriers for Radioactive Waste Confinement, 4th International Meeting, March, 2010, Nantes, France.
- Vilarrasa, V., Rutqvist, J., Blanco-Martin, L., and Birkholzer, J. (2015). Use of a dual structure constitutive model for predicting the long-term behavior of an expansive clay buffer in a nuclear waste repository. *Int. J. Geomech.*, D4015005.
- Viswanathan, H., C. Chu, T. Dittrich, J. Hyman, S. Karra, N. Makendonska, and P. Reimus (2015), *Crystalline and Crystalline International Disposal Activities*, Prepared for U.S. Department of Energy Used Fuel Disposition Campaign, FCRD-UFD-2015-000602, Los Alamos National Laboratory.
- Viswanathan, H., C. Chu, T. Dittrich, J. Hyman, S. Karra, N. Makendonska, and P. Reimus (2016), *Crystalline and Crystalline International Disposal Activities*, Prepared for U.S. Department of Energy Used Fuel Disposition Campaign, FCRD-UFD-2016-000626, Los Alamos National Laboratory.
- Vitel, M., D. Seyed, G. Armand (2016), *Task E: Upscaling of Modeling Results from Small Scale to One-to-one Scale*, Presentation given at 1st DECOVALEX 2019 Workshop, May 2016, Berkeley, USA.
- Vomvoris, S., J.T. Birkholzer, L. Zheng, I. Gays, and I. Blechschmidt (2015), THMC behavior of clay-based barriers under high temperature – from laboratory to URL scale, *Proceedings, International High-Level Radioactive Waste Management Conference*, Charleston, NC, USA, April 12-16, 2015.
- Wang, Y. (editor) (2010), *Natural System Evaluation and Tool Development – FY10 Progress Report*, Prepared for U.S. Department of Energy Used Fuel Disposition Campaign, August 2010, Sandia National Laboratories.

- Wang, Y., et al. (2013). Natural System Evaluation and Tool Development – International Collaborations: FY13 Progress Report, Used Fuel Disposition Campaign Milestone Report - Chapter 2, Interpretations of Colloid-Facilitated Transport Experiments at the Grimsel Test Site from 2008 through 2012. FCRD-UFD-2013-000628.
- Wang, Y., P. Gardner, K.L. Kuhlman, G.-Y. Kim, and S.-H. Ji (2016), *International Collaborations on Fluid Flow in Fractured Crystalline Rocks: FY14 Progress Report*, Prepared for U.S. Department of Energy Used Fuel Disposition Campaign, FCRD-UFD-2014-000499, Sandia National Laboratories.
- Wang, Y., P. Gardner, K.L. Kuhlman, M.L. Kabir, M.L., and S.-H. Ji (2015), *International Collaborations on Fluid Flow in Fractured Crystalline Rocks: FY15 Progress Report*, Prepared for U.S. Department of Energy Used Fuel Disposition Campaign, FCRD-UFD-2015-000711, Sandia National Laboratories.
- Wang, Y., P. Gardner, G.-Y. Kim, and S.-H. Ji (2016), *International Collaboration on Used Fuel Disposition in Crystalline Rocks: FY16 Progress Report*, Prepared for U.S. Department of Energy Used Fuel Disposition Campaign, FCRD-UFD-2016-000629, Sandia National Laboratories.
- Xu, T., N. Spycher, E. Sonnenthal, G. Zhang, L. Zheng, and K. Pruess (2011) TOUGHREACT Version 2.0: A simulator for subsurface reactive transport under non-isothermal multiphase flow conditions. *Computers & Geosciences* 37(6): 763-774.
- Yasuhara, H., A. Polak, Y. Mitani, A. Grader, P. Halleck, and D. Elsworth (2006), Evolution of Fracture Permeability Through Fluid-Rock Reaction Under Hydrothermal Conditions, *Earth Planet. Sci. Lett.* 244: 186–200.
- Yasuhara, H., D. Elsworth, and A. Polak (2004) *The Evolution of Permeability in a Natural Fracture: Significant Role of Pressure Solution*, *J. Geophys. Res.*, 109(B3).
- Yasuhara, H., N. Kinoshita, H. Ohfuji, D.S. Lee, S. Nakashima, and K. Kishida (2011), *Temporal Alteration of Fracture Permeability in Granite Under Hydrothermal Conditions and its Interpretation by Coupled Chemo-Mechanical Model*, *Appl. Geochem.* 26, 2074–2088.
- Zavarin, M., T. Wolery, and C. Atkins-Duffin (2016), *Thermodynamic Database Development and Sorption Database Integration*, Prepared for U.S. Department of Energy Used Fuel Disposition Campaign, M4FT-16LL080302051, Lawrence Livermore National Laboratory.
- Zhang, S.Q., and S.F. Cox (2000), Enhancement of fluid permeability during shear deformation of a synthetic mud. *Journal of Structural Geology*, 22(10), 1385-1393.
- Zheng, L., J. Samper and L. Montenegro (2011). A coupled THC model of the FEBEX in situ test with bentonite swelling and chemical and thermal osmosis. *Journal of Contaminant Hydrology* 126(1–2): 45-60.
- Zheng, L., L. Li, J. Rutqvist H.-H. Liu, and J.T. Birkholzer, (2012), Modeling Radionuclide Transport in Clays. Lawrence Berkeley National Laboratory. FCRD-UFD-2012-000128
- Zheng, L., Rutqvist, J., Steefel, C., Kim, K., Chen, F., Vilarrasa, V., Nakagawa, S., Houseworth, J., and Birkholzer, J. (2014), Investigation of Coupled Processes and Impact of High Temperature Limits in Argillite Rock. Prepared for U.S. Department of Energy, Used Fuel Disposition, FCRD-UFD-2014-000493, Lawrence Berkeley National Laboratory, LBNL-6719E.

- Zheng, L., Rutqvist, J., Kim, K., Houseworth, J. (2015) Investigation of Coupled Processes and Impact of High Temperature Limits in Argillite Rock. Prepared for U.S. Department of Energy, Used Fuel Disposition, FCRD-UFD-2015-000362, Lawrence Berkeley National Laboratory, LBNL-187644.
- Zheng, L. (2016), *FEDEX-DP Collaboration*, Presentation given at UFD Working Group Meeting 2016, June 2016, Las Vegas, USA.
- Zheng, L., K. Kim, H. Xu, and J. Rutqvist (2016), *DR Argillite Disposal R&D at LBNL*, Prepared for U.S. Department of Energy Used Fuel Disposition Campaign, FCRD-UFD-2016-000437, Lawrence Berkeley National Laboratory.
- Zoback, M., A. Kohli, I. Das, and M. McClure (2012), The Importance of Slow Slip on Faults During Hydraulic Fracturing Stimulation of Shale Gas Reservoirs. Society of Petroleum Engineer, SPE155476, The Americas Unconventional Resources Conference, Pittsburgh, Pennsylvania, USA, 5-7 June 2012.
- Zuidema, P. (2007), *Advancements in Deep Geological Disposal of Radioactive Waste through International Cooperation: The Role of Underground Laboratories – Mont Terri Project*, Proceedings of the 10 Year Anniversary Workshop, pp 69-71, Rep. Swiss Geol. Surv. 2.