

BSC

Design Calculation or Analysis Cover Sheet

1. QA: QA
2. Page 1

Complete only applicable items.

3. System Monitored Geologic Repository		4. Document Identifier 000-00C-MGR0-03600-000-00A					
5. Title Nuclear Criticality Calculations for Canister-Based Facilities - Commercial SNF							
6. Group Licensing & Nuclear Safety / Criticality							
7. Document Status Designation <input type="checkbox"/> Preliminary <input checked="" type="checkbox"/> Committed <input type="checkbox"/> Confirmed <input type="checkbox"/> Cancelled/Superseded							
8. Notes/Comments							
Attachments			Total Number of Pages				
Attachment I: Potential Off-Normal Scenario 1 Results			7				
Attachment II: Potential Off-Normal Scenario 2 Results			12				
Attachment III: Potential Off-Normal Scenario 3 Results			10				
Attachment IV: Digital Video Disc Listing			2				
Attachment V: One Digital Video Disc			N/A				
RECORD OF REVISIONS							
9. No.	10. Reason For Revision	11. Total # of Pgs.	12. Last Pg. #	13. Originator (Print/Sign/Date)	14. Checker (Print/Sign/Date)	15. EGS (Print/Sign/Date)	16. Approved/Accepted (Print/Sign/Date)
0A	Initial Issue	131	131	B. A. Matthews <i>B.A. Matthews</i> 01-Nov-07	David M. Vaughn <i>D.M. Vaughn</i> 01-NOV-07	A. Alsaed <i>A. Alsaed</i> 11/1/2007	M. Wisenbarger <i>M. Wisenbarger</i> 11/1/2007

DISCLAIMER

The calculations contained in this document were developed by Bechtel SAIC Company, LLC (BSC) and are intended solely for the use of BSC in its work for the Yucca Mountain Project.

CONTENTS

	Page
1. PURPOSE.....	16
1.1 SCOPE.....	16
1.1.1 TAD Canister Design Concepts Evaluated.....	17
1.1.2 Commercial Spent Nuclear Fuel Evaluated.....	17
1.1.3 Operations Evaluated.....	17
2. REFERENCES	19
2.1 PROCEDURES/DIRECTIVES	19
2.2 DESIGN INPUTS.....	19
2.3 DESIGN CONSTRAINTS	21
2.4 DESIGN OUTPUTS.....	21
3. ASSUMPTIONS.....	22
3.1 ASSUMPTIONS REQUIRING VERIFICATION.....	22
3.1.1 Upper Subcritical Limit	22
3.1.2 TAD Dimensions and Materials	22
3.2 ASSUMPTIONS NOT REQUIRING VERIFICATION.....	26
3.2.1 Density of UO ₂ associated with CSNF	26
3.2.2 Stainless Steel Density in Borated Stainless Steel.....	27
3.2.3 Depleted Uranium Composition	27
3.2.4 Barium Cross Section Substitution.....	28
3.2.5 Hydraulic Fluid Composition	28
3.2.6 Aluminum Cross Section Substitution.....	28
4. METHODOLOGY	30
4.1 QUALITY ASSURANCE.....	30
4.2 USE OF SOFTWARE	30
4.2.1 MCNP	30
4.2.2 EXCEL.....	31
4.3 ANALYSIS PROCESS	31
5. LIST OF ATTACHMENTS	33
6. BODY OF CALCULATION.....	34
6.1 DESCRIPTION OF THE TAD CANISTER.....	34
6.1.1 Design Criteria.....	34
6.2 CRITICALITY SAFETY ANALYSIS MODEL	35
6.2.1 Model Geometry	36
6.2.2 Materials Modeled.....	48
6.3 CALCULATION METHODOLOGY	60
6.3.1 Evaluation of Normal Conditions.....	60
6.3.2 Evaluation of Off-Normal Conditions.....	67
7. RESULTS AND CONCLUSIONS	77

7.1 RESULTS77
7.1.1 Normal Conditions.....77
7.1.2 Potential Off-Normal Conditions83
7.2 CONCLUSIONS.....96

ATTACHMENT I: POTENTIAL OFF-NORMAL SCENARIO 1 RESULTS101
ATTACHMENT II: POTENTIAL OFF-NORMAL SCENARIO 2 RESULTS.....108
ATTACHMENT III: POTENTIAL OFF-NORMAL SCENARIO 3 RESULTS.....120
ATTACHMENT IV: ATTACHMENT DIGITAL VIDEO DISC LISTING.....130

FIGURES

	Page
Figure 1.	Preclosure Criticality Safety Process Flow Diagram..... 32
Figure 2:	Radial Cross-Section of the PWR TAD Canister MCNP Model (Fuel Assemblies Not Illustrated) 38
Figure 3:	Expanded Radial Cross-Section of the PWR TAD Canister MCNP Model Showing a Fuel Compartment (Fuel Assembly Not Illustrated) 38
Figure 4.	Radial Cross-Section of the PWR TAD Canister MCNP Model (Fuel Assemblies Illustrated) 39
Figure 5.	Axial Cross-Section of the PWR TAD Canister MCNP Model (Fuel Assemblies Not Illustrated)..... 39
Figure 6.	Radial Cross-Section of the BWR TAD Canister MCNP Model (Fuel Assemblies Not Illustrated) 42
Figure 7.	Expanded Radial Cross-Section of the BWR TAD Canister MCNP Model Showing a Fuel Compartment (Fuel Assembly Not Illustrated) 42
Figure 8.	Radial Cross-Section of the BWR TAD Canister MCNP Model (Fuel Assemblies Illustrated) 43
Figure 9:.	Axial Cross-Section of the BWR TAD Canister MCNP Model (Fuel Assemblies Not Illustrated)..... 43
Figure 10.	Cross-Section of the Westinghouse 17x17 OFA MCNP Model Showing Pin Map 46
Figure 11:	Cross-Section Illustration of the 7x7 Fuel Assembly Model Showing Pin Map47
Figure 12.	Radial Cross-Section of the PWR TAD Canister MCNP Model with Radial Reflector (Fuel Assemblies Illustrated) 63
Figure 13.	Radial Cross-Section of the BWR TAD Canister MCNP Model with Radial Reflector (Fuel Assemblies Illustrated) 63
Figure 14.	Axial Cross-Section of the Single TAD Canister Models and Infinite Planar Array TAD Canister MCNP Models (Fuel Assemblies Not Illustrated)..... 64
Figure 15.	Radial Cross-Section Illustration of the PWR TAD Canister MCNP Model with Periodic Boundary Condition (to Simulate an Infinite Planar Array of TAD Canisters) 64
Figure 16.	Radial Cross-Section Illustration of the BWR TAD Canister MCNP Model with Periodic Boundary Condition (to Simulate an Infinite Planar Array of TAD Canisters) 65
Figure 17.	Radial Cross-Section of the PWR TAD Canister MCNP Model Illustrating Maximum Fuel Assembly Bunching (Radial Reflector Not Illustrated)..... 65

Figure 18. Radial Cross-Section of the BWR TAD Canister MCNP Model Illustrating Maximum Fuel Assembly Bunching (Radial Reflector Not Illustrated)..... 66

Figure 19. Axial Cross-Section of the Emplacement Configuration TAD Canister MCNP Models (Fuel Assemblies Not Illustrated)..... 67

Figure 20. Radial Cross-Section Sketch of a Damaged PWR TAD Canister Depicting Basket Damage Considered Representative of a Horizontal Impact Event..... 69

Figure 21. Axial Cross-Section of the TAD Canister MCNP Model Depicting Moderator Intrusion (Fuel Assemblies Not Illustrated)..... 72

Figure 22. Radial Cross-Section of the PWR TAD Canister MCNP Model Depicting Maximum Flux Trap Gap Collapse and Maximum Fuel Assembly Birdcaging74

Figure 23. Radial Cross-Section of the BWR TAD Canister MCNP Model Depicting Maximum Flux Trap Gap Collapse and Maximum Fuel Assembly Birdcaging74

Figure 24. Axial Cross-Section of the TAD Canister MCNP Model Depicting Moderator Intrusion in Conjunction with Fuel Release (Fuel Assemblies Not Illustrated) 75

Figure 25. Variation of $k_{eff} + 2\sigma$ with Close Fitting Full-Thickness (I.E. 30 Cm) Reflector Material, for a Single Undamaged Dry PWR TAD Canister Containing Intact, Undamaged, Representative CSNF 78

Figure 26. Variation of $k_{eff} + 2\sigma$ with Close Fitting Full-Thickness (I.E. 30 Cm) Axial Reflector Material, For Infinite Planar Array of Undamaged Dry PWR TAD Canisters, in Close Packed Triangular-Pitched Configuration, and with Each TAD Canister Containing Intact, Undamaged, Representative CSNF..... 79

Figure 27. Variation of $k_{eff} + 2\sigma$ for Infinite Planar Array Of Undamaged Dry TAD Canisters In Close Packed Triangular-Pitched Configuration With Full-Thickness (I.E. 30 Cm) Stainless Steel Axial Reflector, with Each TAD Canister Containing Intact, Undamaged, Representative CSNF, and with Variable Density H2O Moderator Situated in the Interstitial Space Between Each TAD Canister..... 81

Figure 28. Variation of $k_{eff} + 2\sigma$ with Close Fitting Full-Thickness (I.E. 30 Cm) Reflector Material, for Infinitely Long Row (Drift) of Undamaged Dry PWR TAD Canisters, Containing Intact, Undamaged, Representative CSNF..... 82

Figure 29. Maximum Safe Moderator (H₂O) Volume as Function of Fuel Assembly Birdcaging, and Compartment Flux Trap Gap, for Single Damaged, Partially Flooded PWR TAD Canister with 30cm Thick Close Fitting Steel Reflector.. 84

Figure 30. Maximum Safe Moderator (H₂O) Volume as Function of Fuel Assembly Birdcaging, and Compartment Flux Trap Gap, for Single Damaged, Partially Flooded BWR TAD Canister with 30cm Thick Close Fitting Steel Reflector.. 85

Figure 31. Maximum Safe Moderator (H₂O) Volume as Function of Canister BSS Panel Boron Content and Compartment Flux Trap Gap, for Single Damaged, Partially Flooded PWR TAD Canister with 30cm Thick Close Fitting Steel Reflector.. 87

Figure 32. Maximum Safe Moderator (H₂O) Volume as Function of Canister BSS Panel Boron Content and Compartment Flux Trap Gap, for Single Damaged, Partially Flooded BWR TAD Canister with 30cm Thick Close Fitting Steel Reflector.. 88

Figure 33. Variation of $k_{eff} + 2\sigma$ with Variation of Density of Homogeneous UO₂-H₂O Sludge (Based on 5% Fuel Release Positioned at Base of TAD Canister), for Single Undamaged, Partially Flooded PWR TAD Canister with 30cm Thick Close Fitting Steel Reflector..... 90

Figure 34. Maximum Safe Moderator (H₂O) Volume as Function of Fuel Assembly Birdcaging, Compartment Flux Trap Gap and Fuel Release Fraction, for Single Damaged, Partially Flooded PWR TAD Canister with 30cm Thick Close Fitting Steel Reflector..... 91

Figure 35. Maximum Safe Moderator (H₂O) Volume as Function of Fuel Assembly Birdcaging, Compartment Flux Trap Gap and Fuel Release Fraction, for Single Damaged, Partially Flooded PWR TAD Canister with 30cm Thick Close Fitting Steel Reflector..... 92

Figure 36. Variation of $k_{eff} + 2\sigma$ with Close Fitting Full-Thickness (I.E. 30 cm) Reflector Material, for Single Damaged (Maximum Flux Trap Gap Collapse) and Partially Flooded (200 Liters Water Moderator) PWR TAD Canister Containing Intact, Damaged (Maximum Fuel Assembly Birdcaging), Representative CSNF 93

Figure 37. Variation of $k_{eff} + 2\sigma$ with Close Fitting Full-Thickness (I.E. 30 cm) Reflector Material, for Single Damaged (Maximum Flux Trap Gap Collapse) and Partially Flooded (300 Liters Water Moderator) BWR TAD Canister Containing Intact, Damaged (Maximum Fuel Assembly Birdcaging), Representative CSNF 94

Figure 38. Variation of $k_{eff} + 2\sigma$ for Single Damaged and Partially Flooded PWR TAD Canister (With 30cm Thick Steel Reflector) Containing Intact Representative CSNF with No Fuel Deformation (0% Birdcaging) 102

Figure 39. Variation of $k_{eff} + 2\sigma$ for Single Damaged and Partially Flooded PWR TAD Canister (with 30cm Thick Steel Reflector) Containing Intact Representative CSNF with Partial Fuel Deformation (20% Birdcaging) 102

Figure 40. Variation of $k_{eff} + 2\sigma$ for Single Damaged, Partially Flooded PWR TAD Canister (with 30cm Thick Steel Reflector) Containing Intact Representative CSNF with Partial Fuel Deformation (40% Birdcaging) 103

Figure 41. Variation of $k_{eff} + 2\sigma$ for Single Damaged, Partially Flooded PWR TAD Canister (with 30cm Thick Steel Reflector) Containing Intact Representative CSNF with Partial Fuel Deformation (60% Birdcaging) 103

Figure 42. Variation of $k_{eff} + 2\sigma$ for Single Damaged, Partially Flooded PWR TAD Canister (With 30cm Thick Steel Reflector) Containing Intact Representative CSNF with Partial Fuel Deformation (80% Birdcaging) 104

Figure 43. Variation of $k_{eff} + 2\sigma$ for Single Damaged, Partially Flooded PWR TAD Canister (with 30cm Thick Steel Reflector) Containing Intact Representative CSNF with Maximum Fuel Deformation (100% Birdcaging) 104

Figure 44. Variation of $k_{eff} + 2\sigma$ for Single Damaged, Partially Flooded BWR TAD Canister (with 30cm Thick Steel Reflector) Containing Intact Representative CSNF with No Fuel Deformation (0% Birdcaging) 105

Figure 45. Variation of $k_{eff} + 2\sigma$ for Single Damaged, Partially Flooded BWR TAD Canister (with 30cm Thick Steel Reflector) Containing Intact Representative CSNF with Partial Fuel Deformation (20% Birdcaging) 105

Figure 46. Variation of $k_{eff} + 2\sigma$ for Single Damaged, Partially Flooded BWR TAD Canister (with 30cm Thick Steel Reflector) Containing Intact Representative CSNF with Partial Fuel Deformation (40% Birdcaging) 106

Figure 47. Variation of $k_{eff} + 2\sigma$ for Single Damaged, Partially Flooded BWR TAD Canister (with 30cm Thick Steel Reflector) Containing Intact Representative CSNF with Partial Fuel Deformation (60% Birdcaging) 106

Figure 48. Variation of $k_{eff} + 2\sigma$ for Single Damaged, Partially Flooded BWR TAD Canister (with 30cm Thick Steel Reflector) Containing Intact Representative CSNF with Partial Fuel Deformation (80% Birdcaging) 107

Figure 49. Variation of $k_{eff} + 2\sigma$ for Single Damaged, Partially Flooded BWR TAD Canister (with 30cm Thick Steel Reflector) Containing Intact Representative CSNF with Maximum Fuel Deformation (100% Birdcaging) 107

Figure 50. Variation of $k_{eff} + 2\sigma$ for Single Maximum Damaged (No Flux Trap Gap) and Partially Flooded PWR TAD Canister (with 30cm Thick Steel Reflector) Containing Intact Representative CSNF with Maximum Fuel Deformation (I.E. 100% Birdcaging) 109

Figure 51. Variation of $k_{eff} + 2\sigma$ for Single Partially Damaged (0.232 Cm Flux Trap Gap) and Partially Flooded PWR TAD Canister (with 30cm Thick Steel Reflector) Containing Intact Representative CSNF with Maximum Fuel Deformation (I.E. 100% Birdcaging) 109

Figure 52. Variation of $k_{eff} + 2\sigma$ for Single Partially Damaged (0.464 Cm Flux Trap Gap) and Partially Flooded PWR TAD Canister (with 30cm Thick Steel Reflector) Containing Intact Representative CSNF with Maximum Fuel Deformation (I.E. 100% Birdcaging) 110

Figure 53. Variation of $k_{eff} + 2\sigma$ for Single Partially Damaged (0.696 Cm Flux Trap Gap) and Partially Flooded PWR TAD Canister (with 30cm Thick Steel Reflector) Containing Intact Representative CSNF with Maximum Fuel Deformation (I.E. 100% Birdcaging) 110

Figure 54. Variation of $k_{eff} + 2\sigma$ for Single Partially Damaged (0.928 Cm Flux Trap Gap) and Partially Flooded PWR TAD Canister (with 30cm Thick Steel Reflector) Containing Intact Representative CSNF with Maximum Fuel Deformation (I.E. 100% Birdcaging) 111

Figure 55. Variation of $k_{eff} + 2\sigma$ for Single Partially Damaged (1.160 Cm Flux Trap Gap) and Partially Flooded PWR TAD Canister (with 30cm Thick Steel Reflector) Containing Intact Representative CSNF with Maximum Fuel Deformation (I.E. 100% Birdcaging)..... 111

Figure 56. Variation of $k_{eff} + 2\sigma$ for Single Partially Damaged (1.392 Cm Flux Trap Gap) and Partially Flooded PWR TAD Canister (with 30cm Thick Steel Reflector) Containing Intact Representative CSNF with Maximum Fuel Deformation (I.E. 100% Birdcaging)..... 112

Figure 57. Variation of $k_{eff} + 2\sigma$ for Single Partially Damaged (1.624 Cm Flux Trap Gap) and Partially Flooded PWR TAD Canister (with 30cm Thick Steel Reflector) Containing Intact Representative CSNF with Maximum Fuel Deformation (I.E. 100% Birdcaging)..... 112

Figure 58. Variation of $k_{eff} + 2\sigma$ for Single Partially Damaged (1.856 Cm Flux Trap Gap) and Partially Flooded PWR TAD Canister (with 30cm Thick Steel Reflector) Containing Intact Representative CSNF with Maximum Fuel Deformation (I.E. 100% Birdcaging)..... 113

Figure 59. Variation of $k_{eff} + 2\sigma$ for Single Partially Damaged (2.088 Cm Flux Trap Gap) and Partially Flooded PWR TAD Canister (with 30cm Thick Steel Reflector) Containing Intact Representative CSNF with Maximum Fuel Deformation (I.E. 100% Birdcaging)..... 113

Figure 60. Variation of $k_{eff} + 2\sigma$ for Single Partially Damaged (2.320 Cm Flux Trap Gap) and Partially Flooded PWR TAD Canister (with 30cm Thick Steel Reflector) Containing Intact Representative CSNF with Maximum Fuel Deformation (I.E. 100% Birdcaging)..... 114

Figure 61. Variation of $k_{eff} + 2\sigma$ for Single Maximum Damaged (No Flux Trap Gap) and Partially Flooded BWR TAD Canister (with 30cm Thick Steel Reflector) Containing Intact Representative CSNF with Maximum Fuel Deformation (I.E. 100% Birdcaging)..... 114

Figure 62. Variation of $k_{eff} + 2\sigma$ for Single Partially Damaged (0.148 Cm Flux Trap Gap) and Partially Flooded BWR TAD Canister (with 30cm Thick Steel Reflector) Containing Intact Representative CSNF with Maximum Fuel Deformation (I.E. 100% Birdcaging)..... 115

Figure 63. Variation of $k_{eff} + 2\sigma$ for Single Partially Damaged (0.296 Cm Flux Trap Gap) and Partially Flooded BWR TAD Canister (with 30cm Thick Steel Reflector) Containing Intact Representative CSNF with Maximum Fuel Deformation (I.E. 100% Birdcaging)..... 115

Figure 64. Variation of $k_{eff} + 2\sigma$ for Single Partially Damaged (0.444 Cm Flux Trap Gap) and Partially Flooded BWR TAD Canister (with 30cm Thick Steel Reflector) Containing Intact Representative CSNF with Maximum Fuel Deformation (I.E. 100% Birdcaging)..... 116

Figure 65. Variation of $k_{\text{eff}} + 2\sigma$ for Single Partially Damaged (0.592 Cm Flux Trap Gap) and Partially Flooded BWR TAD Canister (with 30cm Thick Steel Reflector) Containing Intact Representative CSNF with Maximum Fuel Deformation (I.E. 100% Birdcaging)..... 116

Figure 66. Variation of $k_{\text{eff}} + 2\sigma$ for Single Partially Damaged (0.740 Cm Flux Trap Gap) and Partially Flooded BWR TAD Canister (with 30cm Thick Steel Reflector) Containing Intact Representative CSNF with Maximum Fuel Deformation (I.E. 100% Birdcaging)..... 117

Figure 67. Variation of $k_{\text{eff}} + 2\sigma$ for Single Partially Damaged (0.888 Cm Flux Trap Gap) and Partially Flooded BWR TAD Canister (with 30cm Thick Steel Reflector) Containing Intact Representative CSNF with Maximum Fuel Deformation (I.E. 100% Birdcaging)..... 117

Figure 68. Variation of $k_{\text{eff}} + 2\sigma$ for Single Partially Damaged (1.036 Cm Flux Trap Gap) and Partially Flooded BWR TAD Canister (with 30cm Thick Steel Reflector) Containing Intact Representative CSNF with Maximum Fuel Deformation (I.E. 100% Birdcaging)..... 118

Figure 69. Variation of $k_{\text{eff}} + 2\sigma$ for Single Partially Damaged (1.184 Cm Flux Trap Gap) and Partially Flooded BWR TAD Canister (with 30cm Thick Steel Reflector) Containing Intact Representative CSNF with Maximum Fuel Deformation (I.E. 100% Birdcaging)..... 118

Figure 70. Variation of $k_{\text{eff}} + 2\sigma$ for Single Partially Damaged (1.332 Cm Flux Trap Gap) and Partially Flooded BWR TAD Canister (with 30cm Thick Steel Reflector) Containing Intact Representative CSNF with Maximum Fuel Deformation (I.E. 100% Birdcaging)..... 119

Figure 71. Variation of $k_{\text{eff}} + 2\sigma$ for Single Partially Damaged (1.480 Cm Flux Trap Gap) and Partially Flooded BWR TAD Canister (with 30cm Thick Steel Reflector) Containing Intact Representative CSNF with Maximum Fuel Deformation (I.E. 100% Birdcaging)..... 119

Figure 72. Variation of $k_{\text{eff}} + 2\sigma$ for Single Damaged, Partially Flooded PWR TAD Canister (with 30cm Thick Steel Reflector) Containing Representative CSNF with No Fuel Deformation (0% Birdcaging) and 1% Fuel Release 121

Figure 73. Variation of $k_{\text{eff}} + 2\sigma$ for Single Damaged, Partially Flooded PWR TAD Canister (with 30cm Thick Steel Reflector) Containing Representative CSNF with Partial Fuel Deformation (20% Birdcaging) and 1% Fuel Release..... 121

Figure 74. Variation of $k_{\text{eff}} + 2\sigma$ for Single Damaged, Partially Flooded PWR TAD Canister (with 30cm Thick Steel Reflector) Containing Representative CSNF with Partial Fuel Deformation (40% Birdcaging) and 1% Fuel Release..... 122

Figure 75. Variation of $k_{\text{eff}} + 2\sigma$ for Single Damaged, Partially Flooded PWR TAD Canister (with 30cm Thick Steel Reflector) Containing Representative CSNF with Partial Fuel Deformation (60% Birdcaging) and 1% Fuel Release..... 122

- Figure 76. Variation of $k_{\text{eff}} + 2\sigma$ for Single Damaged, Partially Flooded PWR TAD Canister (with 30cm Thick Steel Reflector) Containing Representative CSNF with Partial Fuel Deformation (80% Birdcaging) and 1% Fuel Release..... 123
- Figure 77. Variation of $k_{\text{eff}} + 2\sigma$ for Single Damaged, Partially Flooded PWR TAD Canister (with 30cm Thick Steel Reflector) Containing Representative CSNF with Maximum Fuel Deformation (100% Birdcaging) and 1% Fuel Release. 123
- Figure 78. Variation of $k_{\text{eff}} + 2\sigma$ for Single Damaged, Partially Flooded PWR TAD Canister (with 30cm Thick Steel Reflector) Containing Representative CSNF with No Fuel Deformation (0% Birdcaging) and 3% Fuel Release 124
- Figure 79. Variation of $k_{\text{eff}} + 2\sigma$ for Single Damaged, Partially Flooded PWR TAD Canister (with 30cm Thick Steel Reflector) Containing Representative CSNF with Partial Fuel Deformation (20% Birdcaging) and 3% Fuel Release..... 124
- Figure 80. Variation of $k_{\text{eff}} + 2\sigma$ for Single Damaged, Partially Flooded PWR TAD Canister (with 30cm Thick Steel Reflector) Containing Representative CSNF with Partial Fuel Deformation (40% Birdcaging) and 3% Fuel Release..... 125
- Figure 81. Variation of $k_{\text{eff}} + 2\sigma$ for Single Damaged, Partially Flooded PWR TAD Canister (with 30cm Thick Steel Reflector) Containing Representative CSNF with Partial Fuel Deformation (60% Birdcaging) and 3% Fuel Release..... 125
- Figure 82. Variation of $k_{\text{eff}} + 2\sigma$ for Single Damaged, Partially Flooded PWR TAD Canister (with 30cm Thick Steel Reflector) Containing Representative CSNF with Partial Fuel Deformation (80% Birdcaging) and 3% Fuel Release..... 126
- Figure 83. Variation of $k_{\text{eff}} + 2\sigma$ for Single Damaged, Partially Flooded PWR TAD Canister (with 30cm Thick Steel Reflector) Containing Representative CSNF with Maximum Fuel Deformation (100% Birdcaging) and 3% Fuel Release. 126
- Figure 84. Variation of $k_{\text{eff}} + 2\sigma$ for Single Damaged, Partially Flooded PWR TAD Canister (with 30cm Thick Steel Reflector) Containing Representative CSNF with No Fuel Deformation (0% Birdcaging) and 5% Fuel Release 127
- Figure 85. Variation of $k_{\text{eff}} + 2\sigma$ for Single Damaged, Partially Flooded PWR TAD Canister (with 30cm Thick Steel Reflector) Containing Representative CSNF with Partial Fuel Deformation (20% Birdcaging) and 5% Fuel Release..... 127
- Figure 86. Variation of $k_{\text{eff}} + 2\sigma$ for Single Damaged, Partially Flooded PWR TAD Canister (with 30cm Thick Steel Reflector) Containing Representative CSNF with Partial Fuel Deformation (40% Birdcaging) and 5% Fuel Release..... 128
- Figure 87. Variation of $k_{\text{eff}} + 2\sigma$ for a Single Damaged, Partially Flooded PWR TAD Canister (with 30cm Thick Steel Reflector) Containing Representative CSNF with Partial Fuel Deformation (60% Birdcaging) and 5% Fuel Release..... 128
- Figure 88. Variation of $k_{\text{eff}} + 2\sigma$ for Single Damaged, Partially Flooded PWR TAD Canister (with 30cm Thick Steel Reflector) Containing Representative CSNF with Partial Fuel Deformation (80% Birdcaging) and 5% Fuel Release..... 129

Figure 89. Variation of $k_{\text{eff}} + 2\sigma$ for a Single Damaged, Partially Flooded PWR TAD Canister (with 30cm Thick Steel Reflector) Containing Representative CSNF with Maximum Fuel Deformation (100% Birdcaging) and 5% Fuel Release. 129

TABLES

	Page
Table 1.	Design Parameters Assumed for the PWR TAD Canister MCNP Model 24
Table 2.	Design Parameters Assumed for the BWR TAD Canister MCNP Model 25
Table 3.	UO2 Density Estimation for Assembly Types Evaluated 26
Table 4.	Material Specifications for S30400 and S30464 27
Table 5.	Design Parameters Evaluated for the PWR TAD Canister MCNP Model..... 37
Table 6.	Design Parameters Evaluated for the BWR TAD Canister MCNP Model 41
Table 8.	Basic Physical Parameters for the BWR Fuel Assemblies 47
Table 9.	Isotopic Abundances and Atomic Weights..... 49
Table 10.	Material Specification for 316 Stainless Steel..... 50
Table 11.	Material Specification for Borated Stainless Steel 51
Table 12.	Material Specification for Zircaloy-2 54
Table 13.	Material Specification for Zircaloy-4 55
Table 14.	Material Specification for UO2 (5 wt.% 235U Enriched U) 55
Table 15.	Water Material Specification 56
Table 16.	Material Specifications for SAR Concrete 56
Table 17.	Material Specification for 304 Stainless Steel..... 57
Table 18:	Uranium Shield Material Specification 57
Table 19:	Lead Material Specification..... 58
Table 20.	Material Specifications for Savannah River Site High-Level Waste Glass..... 58
Table 21.	Tuff Material Specification..... 59
Table 22.	Titanium Material Specification 59
Table 23.	Material Specification for Alloy 22 (SB-575 N06022) 60
Table 24.	Comparison of $k_{eff} + 2\sigma$ Values ffor Single Undamaged Dry PWR and BWR TAD Canisters Containing Intact, Undamaged, Representative CSNF, and with Close Fitting Full-Thickness (I.E. 30 Cm) Natural Uranium Metal Reflection 78
Table 25.	Comparison of $k_{eff} + 2\sigma$ Values For Infinite Planar Array Of Undamaged Dry PWR And BWR TAD Canisters In Close Packed Triangular-Pitched Configuration With Full-Thickness (I.E. 30 Cm) Stainless Steel Axial Reflector, and with Each TAD Canister Containing Intact, Undamaged, Representative CSNF 80

Table 26.	Comparison of $k_{\text{eff}} + 2\sigma$ Values for Infinitely Long Row (Drift) of Undamaged Dry PWR TAD Canisters, Containing Intact, Undamaged, Representative CSNF, and with Close Fitting Full-Thickness (I.E. 30 Cm) Natural Uranium Metal Reflection Applied to Cylindrical Surface of Canisters	82
Table 27.	Comparison of $k_{\text{eff}} + 2\sigma$ Values for Damaged PWR and BWR TAD Canisters, with Each TAD Canister Containing Water Moderator and Intact, Representative CSNF, with Maximum Fuel Assembly Birdcaging and Complete Canister Compartment Flux Trap Gap Closure	95
Table 28.	Comparison of $k_{\text{eff}} + 2\sigma$ Values for Single Fully Reflected Damaged PWR TAD Canister Containing 200 Liters of Water or Polysiloxane Moderator and Intact, Representative CSNF, with Maximum Fuel Assembly Birdcaging and Complete Canister Compartment Flux Trap Gap Closure	95
Table 29.	Summary of Calculated Maximum Safe Moderator Limits for TAD Canister-Based Systems and their Associated Range of Applicability	99

GLOSSARY OF KEY TERMS

<u>Term</u>	<u>Definition</u>
Birdcaging	A condition resultant from damage to a fuel assembly that has the effect of a localized or widespread increase in the fuel assembly pin pitch.
Flux Trap Gap	That space or medium situated between structure that has the effect (when occupied by moderator) of providing for thermalization of neutrons. In the context of this calculation, the flux trap gap is the space between adjacent fuel assembly compartments.
Fuel Assembly Bunçhing	A condition characterized by displacement of fuel assemblies within their respective TAD canister compartments, to the extent that neutron leakage from the system is reduced or minimized.
Maximum Safe	The value of a parameter that results in a condition in which the effective neutron multiplication factor, k_{eff} , of the system is equal to the Upper Subcritical Limit (USL).
Safe	A condition in which the effective neutron multiplication factor, k_{eff} , of the system is equal to or less than the Upper Subcritical Limit (USL).
Unsafe	A condition in which the effective neutron multiplication factor, k_{eff} , of the system exceeds the Upper Subcritical Limit (USL).

1. PURPOSE

The purpose of this calculation is to perform waste-form specific nuclear criticality safety calculations to aid in establishing criticality safety design criteria, and to identify design and process parameters that are potentially important to the criticality safety of the transportation, aging and disposal (TAD) canister-based systems.

It is intended that the results of the criticality safety calculations provided in this document will be used to support the criticality safety analysis of normal operations and off-normal conditions associated with the handling, transfer and emplacement of TAD canister-based systems in all surface and subsurface facilities, with the exception of the Initial Handling Facility (IHF) and pool operations in the Wet Handling Facility (WHF) (i.e. those operations involving the presence of pool water internal or external to the TAD canister). The criticality safety analysis is provided in Ref. 2.4.1. All off-normal conditions referred to in this document are considered potential end states of category 1 and 2 event sequences.

The criticality safety calculations are performed according to a systematic, methodical process to ensure that the configurations analyzed clearly bound those representative of normal conditions, and to provide assurance that sufficient information is available to establish trends and to determine control parameters and their limits for off-normal conditions. The calculation methodology employed for this analysis is described in detail in Section 6.3. The main elements of the calculation method include:

1. **Simplification:** To reduce or eliminate reliance on design features (e.g. modeling an extensive range of close-fitting full thickness (i.e. 30 cm) reflectors to account for non-fissile materials situated outside the environs of the TAD canisters);
2. **Conservatism:** To reduce or eliminate reliance on design parameters or variation in design parameter values (e.g. a variety of conservative modeling treatments are applied to the Commercial Spent Nuclear Fuel (CSNF) assembly models, as summarized in Section 1.1.2); and
3. **Comprehensiveness:** To assure that an in-depth analysis is performed to completely characterize and establish the relative importance of the key aspects of the design.

1.1 SCOPE

The criticality safety calculations performed and recorded in this document are based on conceptual representations of a TAD canister-based system. Analyses of dual-purpose canisters (DPCs) and Department of Energy (DOE) Spent Nuclear Fuel (SNF) canisters are the subject of other, separate documents. Analysis of sealed waste packages containing naval SNF is provided in the Naval Nuclear Propulsion Program Technical Support Document. Interaction between TAD canisters and DOE SNF canisters will be addressed in the Preclosure Criticality Safety Analysis (Ref. 2.4.1).

1.1.1 TAD Canister Design Concepts Evaluated

Two TAD canister conceptual representations are considered; a pressurized water reactor (PWR) CSNF canister variant and a boiling water reactor (BWR) canister variant. Each conceptual representation is described in detail in Section 6.2.1.1, and complies with the design criteria (Section 6.1.1) established for TAD canister-based systems in Ref. 2.2.6 (pg. 8 & 15).

The TAD canister Monte Carlo N-Particle (MCNP) models are constructed in a manner that permits an extensive range of design variations to be readily examined, as described in Section 6.2.1.1. While the primary intent of the design variations considered is to establish trends in the system behavior to potential off-normal conditions that result in canister damage, the established data can be used to examine the efficacy of alternate canister designs.

1.1.2 Commercial Spent Nuclear Fuel Evaluated

The CSNF assemblies modeled in the TAD canister calculations are limited to two assembly types that are based on the Westinghouse Electric 17x17 Optimized Fuel Assembly (OFA) and the General Electric (GE) 7x7 Fuel Assembly. Design information related to the PWR and BWR fuel assembly types included in the scope of this document is provided in Sections 6.2.1.2.1 and 6.2.1.2.2, respectively.

Numerous CSNF assembly model simplifications (Section 6.2.1.2.1) are implemented which have the effect of introducing a level of conservatism in the calculations. In addition to conservative modeling practices, extensive sensitivity studies (Section 6.3.2) are performed to determine the susceptibility of evaluated criticality safety limits (i.e. maximum safe moderator volume) to pronounced changes in the fuel assembly design, including substantial variations in the fuel pin pitch. While the primary intent of these sensitivity studies is to characterize system behavior under potential off-normal conditions, the evaluated data provides an understanding of the sensitivity of the system to perturbations in the fuel assembly design.

1.1.3 Operations Evaluated

All TAD canisters received and accepted into the surface and subsurface facilities examined in this document¹ will be hermetically sealed, with a dry, intact, basket containing intact CSNF with a maximum initial enrichment of 5 weight percent (wt %) ²³⁵U/U. Under all normal conditions, operations associated with receipt and handling of the TAD canisters in the surface facilities, in addition to operations concerned with emplacement of the TAD canisters within the Subsurface, will not alter these conditions.

¹ Note that the WHF pool and the IHF are excluded from the scope of surface facilities in this criticality safety calculation.

1.1.3.1 Anticipated Surface Facility and Intra-Site Operations

Operations conducted in the surface facilities¹ (which include Intra-Site operations) concern the preparation of the received TAD canisters for loading into waste packages and emplacement in the Subsurface facility. These preparatory operations primarily entail:

- Receipt of transportation casks containing CSNF in TAD canisters;
- Unpending and removal of transportation casks from their conveyance, including unbolting and removal of lids from casks;
- Transfer of the TAD canisters from their transportation cask to an aging overpack;
- Transfer of TAD canisters in aging overpacks between the Receipt Facility (RF) the WHF, the Canister Receipt and Closure Facility (CRCF), and the Aging Facility;
- Aging of TAD canisters in aging overpacks on an aging pad;
- Receipt of loaded TAD canisters inside aging overpacks from the aging pad;
- Transfer of canisters from transportation casks and aging overpacks into waste packages;
- Installation and welding of waste package inner and outer lids; and
- Transfer of the completed sealed waste packages, using the transport and emplacement vehicle (TEV), to the Subsurface facility.

1.1.3.2 Anticipated Subsurface Facility Operations

Operations conducted in the Subsurface facility concern the receipt of the TEV and subsequent unloading and placement of sealed waste packages into the repository disposal drifts.

2. REFERENCES

This section details the references used in this calculation. The Document Input Reference system (DIRS) number is provided (within parenthesis) for each applicable reference.

2.1 PROCEDURES/DIRECTIVES

- 2.1.1 BSC 2007. *Calculations and Analyses*. EG-PRO-3DP-G04B-00037, Rev.09. Las Vegas, Nevada: Bechtel SAIC Company. ACC: ENG.20070717.0004. (DC53238).
- 2.1.2 BSC 2007. *Preclosure Safety Analysis Process*. LS-PRO-0201, Rev. 05. Las Vegas, Nevada: Bechtel SAIC Company. ACC: ENG.20071010.0021. (DC54505).
- 2.1.3 BSC 2007. *Preclosure Criticality Analysis Process Report*. TDR-DS0-NU-000001, Rev. 02. Las Vegas, Nevada: Bechtel SAIC Company. ACC: DOC.20071023.0011 (DIRS 182214).
- 2.1.4 BSC 2007. Rev. 07, *Software Management*. IT-PRO-0011, Las Vegas, Nevada: Bechtel SAIC Company. ACC: DOC.20070905.0001 (DC 53898).
- 2.1.5 BSC 2007. *Quality Management Directive*, QA-DIR-10, Rev. 01. Las Vegas, Nevada: Bechtel SAIC Company. ACC: DOC.20070330.0001. (DC 51536).
- 2.1.6 BSC 2007. *Qualification of Software*. IT-PRO-0012, Rev. 04. Las Vegas, Nevada: Bechtel SAIC Company. ACC: DOC.20070319.0014. (DC 51230)
- 2.1.7 BSC 2007. *Desktop Information for Using CalcTrac*. EG-DSK-3013, Rev. 02., Las Vegas, Nevada: Bechtel SAIC Company. ACC: ENG.20070516.0024. (DC 52227).

2.2 DESIGN INPUTS

- 2.2.1 BSC (Bechtel SAIC Company) 2006. *Dimension and Material Specification Selection for Use in Criticality Analyses*. CAL-DSU-NU-000017 REV 0A. Las Vegas, Nevada: Bechtel SAIC Company. ACC: DOC.20060906.0004 (DIRS 177193).
- 2.2.2 Briesmeister, J.F., ed. 1997. *MCNP-A General Monte Carlo N-Particle Transport Code. LA-12625-M, Version 4B*. Los Alamos, New Mexico: Los Alamos National Laboratory. ACC: MOL.19980624.0328 (DIRS 103897).
- 2.2.3 CRWMS M&O 1998. *Software Qualification Report for MCNP Version 4B2, A General Monte Carlo N-Particle Transport Code*. CSCI: 30033 V4B2LV. DI: 30033-2003, Rev. 01. Las Vegas, Nevada: CRWMS M&O. ACC: MOL.19980622.0637 (DIRS 102836).
- 2.2.4 BSC (Bechtel SAIC Company) 2004. *Criticality Model*. CAL-DS0-NU-000003 REV 00A. Las Vegas, Nevada: Bechtel SAIC Company. ACC: DOC.20040913.0008; DOC.20050728.0007 (DIRS 168553).

- 2.2.5 Baum, E.M.; Knox, H.D.; and Miller, T.R. 2002. *Nuclides and Isotopes*. 16th edition. [Schenectady, New York]: Knolls Atomic Power Laboratory. TIC: 255130. (DIRS 175238).
- 2.2.6 DOE (U.S. Department of Energy) 2007. *Transportation, Aging, and Disposal Canister System Performance Specification*. WMO-TADCS-000001, Rev. 0. Washington, D.C.: U.S. Department of Energy, Office of Civilian Radioactive Waste Management. ACC: DOC.20070614.0007 (DIRS 181403).
- 2.2.7 ASTM A 887-89 (Re-approved 2004). 2004. *Standard Specification for Borated Stainless Steel Plate, Sheet, and Strip for Nuclear Application*. West Conshohocken, Pennsylvania: American Society for Testing and Materials. TIC: 258746 (DIRS 178058).
- 2.2.8 NRC (U.S. Nuclear Regulatory Commission) 2000. *Standard Review Plan for Spent Fuel Dry Storage Facilities*. NUREG-1567. Washington, D.C.: U.S. Nuclear Regulatory Commission. TIC: 247929 (DIRS 149756).
- 2.2.9 DOE (U.S. Department of Energy) 1987. Appendix 2A *Physical Descriptions of LWR Fuel Assemblies. Volume 3 of Characteristics of Spent Fuel, High-Level Waste, and Other Radioactive Wastes Which May Require Long-Term Isolation* DOE/RW-0184. Washington, D.C.: U.S. Department of Energy, Office of Civilian Radioactive Waste Management. ACC: HQX.19880405.0024 (DIRS 132333).
- 2.2.10 CRWMS M&O 1998. *Summary Report of Commercial Reactor Criticality Data for McGuire Unit 1*. B00000000-01717-5705-00063 REV 01. Las Vegas, Nevada: CRWMS M&O. ACC: MOL.19980622.0079 (DIRS 106022).
- 2.2.11 Lide, D.R., ed. 2006. *CRC Handbook of Chemistry and Physics*. 87th Edition. Boca Raton, Florida: CRC Press. TIC: 258634 (DIRS 178081).
- 2.2.12 Gelest, Inc. 2004. *Gelest Silicone Fluids: Stable, Inert Media*. Morrisville, Pennsylvania: Gelest, Inc. TIC: 256122 (DIRS 169915).
- 2.2.13 CRWMS M&O 1999 *DOE SRS HLW Glass Chemical Composition*. BBA000000-01717-0210-00038 REV 00. Las Vegas, Nevada: CRWMS M&O. ACC: MOL.19990215.0397 (DIRS 102140).
- 2.2.14 Stout, R.B. and Leider, H.R., eds. 1991. *Preliminary Waste Form Characteristics Report* Version 1.0. Livermore, California: Lawrence Livermore National Laboratory. ACC: MOL.19940726.0118 (DIRS 102813).
- 2.2.15 Peterman, Z.E. 2000 GS000308313211.001. *Geochemistry of Repository Block*. MOX-000412-24-02. U.S. Geologic Survey (DIRS 162015).

- 2.2.16 ASTM A 240/A 240M-06c. 2006. *Standard Specification for Chromium and Chromium-Nickel Stainless Steel Plate, Sheet, and Strip for Pressure Vessels and for General Applications* West Conshohocken, Pennsylvania: American Society for Testing and Materials. TIC: 259153 (DIRS 179346).
- 2.2.17 Larsen, N.H.; Parkos, G.R.; and Raza, O. 1976. *Core Design and Operating Data for Cycles 1 and 2 of Quad Cities 1*. EPRI NP-240. Palo Alto, California: Electric Power Research Institute. TIC: 237267. (DIRS 146576).
- 2.2.18 BSC (Bechtel SAIC Company) 2005. *CSNF Assembly Type Sensitivity Evaluation for Pre- and Postclosure Criticality Analysis*. CAL-DSU-NU-000013 REV 00A. Las Vegas, Nevada: Bechtel SAIC Company. ACC: DOC.20050525.0006 (DIRS 175046).
- 2.2.19 MCNP V. 4B2LV.2002. WINDOWS 2000.STN: 10437-4B2LV-00.
- 2.2.20 BSC (Bechtel SAIC Company) 2007. *IED Geotechnical and Thermal Parameters*. 800-IED-MGR0-00401-000 Rev 00G. Las Vegas, Nevada: Bechtel SAIC Company. ACC: ENG.20070601.0020 (DIRS 179928).

It is noted that Reference 2.2.9 is "QA-NA" but is used as "direct input" based on the context of its use (i.e. "data" only). This reference is suitable for its intended use in this document because the data refers to fuel assembly characteristics that are representative of the broader CSNF assembly population.

It is also noted that References 2.2.12 and 2.2.17 are "inputs from outside sources". These references are suitable for their intended use in this document because the data is considered representative and the safety limits established in this document are considered insensitive to the exact values used.

2.3 DESIGN CONSTRAINTS

None.

2.4 DESIGN OUTPUTS

- 2.4.1 Preclosure Criticality Safety Analysis.

3. ASSUMPTIONS

3.1 ASSUMPTIONS REQUIRING VERIFICATION

3.1.1 Upper Subcritical Limit

Assumption: The Upper Subcritical Limit (USL) for all calculations reported in this document is assumed to be 0.92, which includes a 0.05 administrative margin.

Rationale: The largest bias and uncertainty for benchmarks applicable to PWR and BWR CSNF configurations, as summarized in Table 5 of the Criticality Model (Ref. 2.2.4), is 0.023. Range of applicability extension to cover the range of parameters for all normal and potential off-normal conditions may necessitate the use of additional benchmarks or the establishment of a penalty on the USL (Δk_{EROA}) to account for extension of the range of applicability. The extension of the range of applicability is not expected to result in a bias and uncertainty larger than 0.03.

Use: This assumption applies to the results and conclusions of all calculations described in this document.

Confirmation Status: This assumption requires confirmation by analysis and is tracked via CalcTrac (*Desktop Information for Using CalTrac* (Ref. 2.1.7)). The required analysis will validate the criticality computational method (MCNP4B2) using applicable benchmarks to determine the bias and bias uncertainties associated with how well MCNP4B2 and associated cross-section data predict the k_{eff} of the configurations considered in this calculation.

3.1.2 TAD Dimensions and Materials

Assumption: The *Transportation, Aging and Disposal Canister System Performance Specification* (Ref. 2.2.6, pg. 8 & 15) stipulates basic design criteria for TAD canister-based systems. Certain dimensions and materials of construction of the TAD canister are not explicitly defined in Ref. 2.2.6 but are required in order to define criticality safety models. The model parameters that have been assumed in the criticality safety models are defined and discussed in detail in Section 6.2.1.1. The model parameters that have been assumed are summarized in Tables 1 and 2.

Rationale: The assumed dimensions and internal arrangement modeled configurations are considered to reflect typical design practices for CSNF transportation packages and are considered appropriate for this analysis. Furthermore, all of the parameters and values selected for parameters are compliant with the *Transportation, Aging and Disposal Canister System Performance Specification* (Ref. 2.2.6, pg. 8 & 15).

The majority of the parameters listed in Table 1 and 2 that do not have specific design criteria are those parameters relating to the thickness of the canister wall, base, lid, and the canister height. The actual value assumed for these parameters in the criticality safety calculations is relatively unimportant (Section 6.2.1.1.1).

The remaining parameters listed in Table 1 and 2 can have a strong influence on the criticality safety performance of the TAD canister-based system, in particular, the values selected for the fuel compartment inner width and the spacing between adjacent compartments. Because these two main parameters directly influence the criticality safety performance of the canister system, their values have been selected to minimize this sensitivity, as should be the case when designing a CSNF transportation canister. In addition, the off-normal scenarios evaluated in this document (Section 6.3.2) consider a wide variation in value of the predominant compartment-compartment spacing parameter, which reduces the sensitivity of the results to uncertainty in the actual TAD canister design.

Use in the Calculation: The assumed dimensions and internal arrangement (Tables 1 and 2) are integral components of all TAD canister MCNP models utilized in this document.

Confirmation Status: The dimensions and internal arrangement of the TAD canister (and the associated integrated basket) must be verified. This assumption is tracked via CalcTrac (*Desktop Information for Using CalTrac* (Ref. 2.1.7)).

Table 1. Design Parameters Assumed for the PWR TAD Canister MCNP Model

Design Parameter	MCNP Model		Design Criteria
<i>TAD body</i>			
Inner diameter of TAD canister	65.0"	165.10 cm	No specific criteria
Outer length/height of TAD canister ^b	211.5"	537.21 cm	211.5" (min), 212.0" (max)
TAD spacer ^b	Not modeled		Required for TAD Canisters less than 211.5" in height.
Inner length/height of TAD canister	210.5"	534.67 cm	No specific criteria
TAD base thickness	0.5"	1.27 cm	No specific criteria
TAD lid thickness	0.5"	1.27 cm	No specific criteria
<i>TAD basket structure</i>			
Inner width of fuel assembly compartment	9.0"	22.86 cm	No specific criteria
Compartment inner wall thickness	0.1875"	0.48 cm	No specific criteria
Compartment borated stainless steel panel arrangement ^c	Four panels around each compartment with a flux trap between		Panels must surround all four longitudinal sides of assemblies
Borated stainless steel panel thickness between adjacent fuel assemblies ^d	0.8 cm ((0.6 cm + (4 × 250 nm/yr × 10,000 yr)/2)		6 mm remaining after 10,000 yr with 250 nm/yr of corrosion for each surface
Basket height	Same as assembly height ^a		The BSS plates are required to cover the entire active fuel region plus an allowance for any axial shift in the fuel assemblies
Compartment outer wall thickness	0.1875"	0.48 cm	No specific criteria
Outer width of fuel assembly compartment	10.38"	26.37 cm	No specific criteria
Spacing between compartments (surface-to-surface) ⁽³⁾	0.0" - 0.91"	0 - 2.32 cm	No specific criteria
Axial placement of fuel/basket in TAD ^a	Fuel/basket modeled to sit directly on the base of the TAD cavity		No specific criteria

NOTES: ^a The active fuel region and basket height are conservatively modeled equivalent to the fuel assembly height.

^b The provision of a TAD waste package 'spacer' is reserved for TAD canisters with external heights less than 211.5". The TAD waste package spacer is a feature that is external to the TAD canister and is not modeled in the criticality safety calculations.

^c The modeled canister basket structure design features a gap between adjacent fuel assembly compartments, commonly referred to as a flux trap gap. This arrangement is typical of CSNF canister designs and complies with the *Transportation, Aging and Disposal Canister System Performance Specification* (Ref. 2.2.6, pg. 8 & 15).

^d The provision of a flux trap gap results in two neutron absorber panels between adjacent assemblies. Accounting for 250 nm corrosion per year on each surface of the panels over a 10,000-year period results in a total thickness reduction of 10mm. Based on this corrosion allowance and a design specification of 8mm per panel, with two panels between adjacent assemblies, it is seen that a total thickness of 6mm is retained at 10,000 years.

Source: Original

Table 2. Design Parameters Assumed for the BWR TAD Canister MCNP Model

Design Parameter	MCNP Model		Design Criteria
<i>TAD body</i>			
Inner diameter of TAD canister	65.0"	165.10 cm	No specific criteria
Outer length/height of TAD canister ^b	211.5"	537.21 cm	211.5" (min), 212.0" (max)
TAD spacer ^b	Not modeled		Required for TAD Canisters less than 211.5" in height.
Inner length/Height of TAD canister	210.5"	534.67 cm	No specific criteria
TAD base thickness	0.5"	1.27 cm	No specific criteria
TAD lid thickness	0.5"	1.27 cm	No specific criteria
<i>TAD basket structure</i>			
Inner width of fuel assembly compartment	6.0"	15.24 cm	No specific criteria
Compartment inner wall thickness	0.125"	0.32 cm	No specific criteria
Compartment borated stainless steel panel arrangement ^c	Four panels around each compartment with a flux trap between		Panels must surround all four longitudinal sides of assemblies
Borated stainless steel panel thickness between adjacent fuel assemblies ^d	0.8 cm ((0.6 cm + (4 × 250 nm/yr × 10,000 yr)/2)		6 mm remaining after 10,000 yr with 250 nm/yr of corrosion for each surface
Basket height	Same as assembly height ^a		The BSS plates are required to cover the entire active fuel region plus an allowance for any axial shift in the fuel assemblies
Compartment outer wall thickness	0.125"	0.32 cm	No specific criteria
Outer width of fuel assembly compartment	7.13"	18.11 cm	No specific criteria
Spacing between compartments (surface-to-surface) ^c	0.0" - 0.58"	0 - 1.48 cm	No specific criteria
Axial placement of fuel/basket in TAD ^a	Fuel/basket modeled to sit directly on the base of the TAD cavity		No specific criteria

NOTES: ^a The active fuel region and basket height are conservatively modeled equivalent to the fuel assembly height.

^b The provision of a TAD waste package 'spacer' is reserved for TAD canisters with external heights less than 211.5". The TAD waste package spacer is a feature that is external to the TAD canister and is not modeled in the criticality safety calculations.

^c The modeled canister basket structure design features a gap between adjacent fuel assembly compartments, commonly referred to as a flux trap gap. This arrangement is typical of CSNF canister designs and complies with the *Transportation, Aging and Disposal Canister System Performance Specification* (Ref. 2.2.6, pg. 8 & 15).

^d The provision of a flux trap gap results in two neutron absorber panels between adjacent assemblies. Accounting for 250nm corrosion per year on each surface of the panels over a 10,000-year period results in a total thickness reduction of 10mm. Based on this corrosion allowance and a design specification of 8mm per panel, with two panels between adjacent assemblies, it is seen that a total thickness of 6mm is retained at 10,000 years.

Source: Original

3.2 ASSUMPTIONS NOT REQUIRING VERIFICATION

3.2.1 Density of UO₂ associated with CSNF

Assumption: The density of the UO₂ fuel considered when evaluating CSNF in this calculation is conservatively assumed to be 10.751 g/cm³, which corresponds to 98% of the theoretical density for naturally enriched UO₂ (10.97 g/cm³) (*CRC Handbook of Chemistry and Physics* (Ref. 2.2.11, page 4-97)).

Rationale: Based upon a review of the uranium mass per assembly, the active fuel length, fuel pellet diameter, and number of fuel rods per assembly, as given in Ref. 2.2.1, it is seen that the maximum effective density of CSNF UO₂ in the assembly types evaluated is 10.31 g/cm³ (Table 3). Therefore, the assumed artificially high density of UO₂ (10.751 g/cm³) in the CSNF MCNP models results in the presence of more fuel per assembly than is reflected by CSNF design. Consequently, this modeling assumption imposes a degree of conservatism in the criticality safety analysis.

Use in the Calculation: Used in the determination of the UO₂ material specification for CSNF in Section 6.2.2.2.

Table 3. UO₂ Density Estimation for Assembly Types Evaluated

Assembly Design Parameter ^c	W 17x17 (OFA)	7x7
Active fuel length - h _F (cm)	365.76	365.76
Fuel pellet OD - D _P (cm) ^d	0.784352	1.23952
U mass - M _U (kg per assembly)	423.12	^a
Number of guide and instrument tubes	25	0
Fuel Volume in Rod (cc) $V_F = \pi \times \left(\frac{D_P}{2}\right)^2 \times h_F$	176.729	441.3602
Number of fuel Rods - N _F	17 ² -25=264	7 ² =49
Fuel Volume - V _{Fuel} =V _F × N _F (cc)	46656.49	21626.64
UO ₂ Mass (kg) ^b - $M_{UO_2} = \frac{M_U}{wf_{235U} + wf_{238U}}$	480.03	222.98 ⁽¹⁾
UO ₂ Density (g/cc) - $\rho_{UO_2} = \frac{M_{UO_2} \times 1000}{V_{Fuel}}$	10.289	10.310

NOTES: ^a The UO₂ mass is based on the largest UO₂ value quoted in Table 3 of *Core Design and Operating Data for Cycles 1 and 2 of Quad Cities 1* (Ref. 2.2.17).

^b The values of wf_{235U} & wf_{238U} are the weight fraction of each isotope in UO₂ with a uranium enrichment of 5 wt% ²³⁵U. These values are based on the weight percent values determined in Section 6.2.2.2.

^c Physical parameters are based on *Dimension and Material Specification for Use in Criticality Analyses* (Ref. 2.2.1, Table 71), unless otherwise noted.

^d Fuel pellet OD based on Table 5-1 of *CSNF Assembly Type Sensitivity Evaluation for Pre- and Postclosure Criticality Analysis* (Ref. 2.2.18).

Source: References 2.2.1, 2.2.17 and 2.2.18.

3.2.2 Stainless Steel Density in Borated Stainless Steel

Assumption: Transportation, Aging, and Disposal Canister System Performance Specification (Ref. 2.2.6, pg. 8 & 15) requires that the TAD canister incorporate S30464 borated stainless steel as described in ASTM A887-89 (*Standard Specification for Borated Stainless Steel Plate, Sheet, and Strip for Nuclear Application*, (Ref. 2.2.7)) as a neutron absorber within the TAD basket structure. Since the ASTM A887-89 specification does not provide an overall density for the borated stainless steel, the density of the borated stainless is determined assuming that the stainless steel component of the borated stainless steel is 304 stainless steel.

Rationale: In comparing the chemical composition requirements of the S30464 borated stainless steel with that of the S30400 stainless steel (Table 4), it is seen that the chemical composition requirements are identical except for the boron content, nickel content, and the residual iron content. On this basis, it is reasonable to utilize the density of S30400 stainless steel (7.94 g/cm^3 , *Dimension and Material Specification Selection for Use in Criticality Analyses* (Reference 2.2.1, Table 12)) in determining the density of the S30464 borated stainless steel. It is noted that the additional nickel content in the S30464 specification may result in a slightly higher overall density due to its higher density in comparison to the other elements. However, neglecting this effect is conservative since the use of a slightly lower density results in a slight decrease in the boron concentration in the borated stainless steel.

Table 4. Material Specifications for S30400 and S30464

UNS Designation	Carbon (wt. %)	Manganese (wt. %)	Phosphorous (wt. %)	Sulfur (wt. %)	Silicon (wt. %)	Chromium (wt. %)	Nickel (wt. %)	Nitrogen (wt. %)
S30464 ^a	0.08	2.00	0.045	0.030	0.75	18.0-20.0	12.0-15.0	0.10 max
S30400 ^b	0.08	2.00	0.045	0.030	0.75	18.0-20.0	8.0-10.5	0.10

Source: ^a Table 1 of *Standard Specification for Borated Stainless Steel Plate, Sheet, and Strip for Nuclear Application* (Ref. 2.2.7).

^b Table 1 of *Standard Specification for Chromium and Chromium-Nickel Stainless Steel Plate, Sheet, and Strip for Pressure Vessels and for General Applications* (Ref. 2.2.16).

Use in the Calculation: The S30400 density is utilized in Section 6.2.2.1 for determination of the density of borated stainless steel used in the TAD basket structure.

3.2.3 Depleted Uranium Composition

Assumption: Depleted uranium metal is modeled as naturally enriched uranium metal.

Rationale: Depleted uranium metal may be used as a radiation shield associated with the TAD, DPC or waste package transportation casks. The depleted uranium associated with these shields (if present) would, by definition, have a ^{235}U content less than what is found naturally. The exact content, however, may vary depending on source. Therefore, for the purpose of this calculation, the ^{235}U content is conservatively set to that found in naturally occurring uranium with the balance being ^{238}U . From a criticality safety perspective, this is conservative because it assumes

the presence of additional fissile material (used as a reflector in this assessment) than would be present in practice.

According to *Nuclides and Isotopes* (Ref. 2.2.5, pg. 70), the ^{235}U abundance in natural uranium is 0.72 atom percent. The balance (i.e. ^{238}U) represents 99.28 atom percent.

Use in the Calculation: The natural uranium isotopic content of ^{235}U is used to define the composition of depleted uranium which is used as a reflector in the criticality safety analysis.

3.2.4 Barium Cross Section Substitution

Assumption: Since the Ba-137 cross section libraries are unavailable, it is assumed that representing the Ba-137 material composition in Savannah River Site High-Level Waste Glass as Ba-138 would maintain similar neutronic characteristics.

Rationale: The rationale for this assumption is that the thermal neutron capture cross-section and resonance integral of Ba-137 (*Nuclides and Isotopes* (Ref. 2.2.5, pg. 56)) are greater than the thermal neutron capture cross-section and the resonance integral of Ba-138 (*Nuclides and Isotopes* (Ref. 2.2.5, pg. 56)), which results in less parasitic capture, and is therefore conservative with respect to criticality safety evaluations.

Use in the Calculation: This assumption is used in Section 6.2.2.3.

3.2.5 Hydraulic Fluid Composition

Assumption: It is assumed that the hydraulic fluid considered as an alternative moderator material in this calculation is a conventional silicone fluid (polysiloxane fluid) with a viscosity of 10cSt with a degree of polymerization of four (which is necessary for a viscosity of 10cSt at 25°C (*Gelest Silicone Fluids: Stable, Inert Media* (Ref. 2.2.12, p.11))).

Rationale: The basis for this assumption is that polysiloxane fluid is a common silicone based hydraulic fluid (*Gelest Silicone Fluids: Stable, Inert Media* (Ref. 2.2.12, p. 7)), and is therefore representative for the purpose of evaluating the moderating effectiveness of hydraulic fluid in this calculation.

Use in the Calculation: This assumption is used in Section 7.1.2.1.2.

3.2.6 Aluminum Cross Section Substitution

Assumption: Since the zinc cross section libraries are unavailable, it was assumed that representing the zinc material composition in the Savannah River Site High-Level Waste Glass material specification (Table 20) as aluminum would maintain similar neutronic characteristics.

Rationale: The rationale for this assumption is that the thermal neutron absorption cross-section and resonance integral for these two elements are sufficiently similar and very small (0.230, 0.17 for Al, and 1.1, 2.8 for Zn) (*Nuclides and Isotopes* (Ref. 2.2.5, pg. 42 & 48)), with Al being slightly less than Zn which is conservative for eigenvalue calculations. In addition, Zn is present

in only trace quantities and therefore the reaction rate impact on the system would be negligible in terms of neutron spectrum influence.

Use in the Calculation: This assumption is used in Section 6.2.2.3.

4. METHODOLOGY

4.1 QUALITY ASSURANCE

This calculation is prepared in accordance with EG-PRO-3DP-G04B-00037, *Calculations and Analyses* (Ref. 2.1.1) and LS-PRO-0201, *Preclosure Safety Analyses Process* (Ref. 2.1.2). Therefore, the approved record version has a quality assurance designation of QA:QA. This calculation is subject to the *Quality Assurance Requirements and Description* (QARD) (Ref. 2.1.5).

4.2 USE OF SOFTWARE

4.2.1 MCNP

The base-lined Monte Carlo N-Particle (MCNP) code (Ref. 2.2.19) is used to calculate the effective neutron multiplication factor (k_{eff}) of single isolated TADs, and TAD arrays, with both PWR and BWR representative CSNF payloads. The MCNP software specification is as follows:

- Software Title: MCNP
- Version/Revision Number: Version 4B2LV
- Status/Operating System: Qualified/Microsoft Windows 2000 Service Pack 4
- Software Tracking Number: 10437-4B2LV-00 (Computer Software Configuration Item Number)
- Computer Type: Dell OPTIPLEX GX260 Workstations

The input and output files for the MCNP calculations are contained on a Digital Video Disc (DVD) attachment to this calculation report (Attachment V), as detailed in Attachment IV. The MCNP software has been validated as being appropriate for use in modeling a range of radiation transport problems as documented in *Software Qualification Report for MCNP Version 4B2, A General Monte Carlo N-Particle Transport Code* (Ref. 2.2.3). The range of validated problems includes cases where MCNP is used to determine k_{eff} of systems containing fissile material. The use of MCNP in determining k_{eff} values is further documented in *A General Monte Carlo N-Particle Transport Code* Ref. 2.2.2. The MCNP software was obtained from Software Configuration Management in accordance with the appropriate procedure *Software Management* (Ref. 2.1.4).

The software qualification report *Software Qualification Report for MCNP Version 4B2, A General Monte Carlo N-Particle Transport Code* (Ref. 2.2.3) was performed prior to the effective date of IT-PRO-0012, *Qualification of Software* (Ref. 2.1.6), however, MCNP Version 4B2 was qualified software in the centralized baseline as of the effective date of IT-PRO-0012 and is therefore considered acceptable and part of the established software baseline available for level 1 usage *Qualification of Software* (Paragraph 1.2.3 of Reference 2.1.6).

4.2.2 EXCEL

- Software Title: Excel
- Version/Revision number: Microsoft® Excel 2003 11.8120.8122 SP-2 (on an OPTIPLEX GX620 Workstation)
- Computer Environment for Microsoft® Excel 2003: Software is installed on a DELL OPTIPLEX GX620, personal computer, running Microsoft Windows XP Professional, Version 2002, Service Pack 2.

Microsoft Excel for Windows is used in calculations and analyses to process the results of the MCNP calculations, using standard mathematical expressions and operations. It is also used to tabulate and chart the MCNP results. The user-defined formulas, inputs, and results are documented in sufficient detail to allow an independent repetition of computations. Thus, Microsoft Excel is used only as a worksheet and not as a software routine. The use of Excel in the calculation constitutes Level 2 software usage, which does not require qualification *Software Management* (Ref. 2.1.4, Attachment 12).

The Microsoft Excel spreadsheets generated for the calculations developed in support of this document are provided in the Microsoft Excel workbook *tad_canister_calculations.xls*, included in the DVD file of Attachment V. The Excel calculations and graphical presentations were verified by hand calculations and visual inspection.

4.3 ANALYSIS PROCESS

This calculation is performed in support of the criticality safety analysis process described in the *Preclosure Criticality Analysis Report* (Ref. 2.1.3). The key elements of the criticality safety analysis process are detailed in Figure 1. The calculations reported in this document specifically address function (1), highlighted in Figure 1. This is accomplished by determining the effective neutron multiplication factor (k_{eff}) of TAD canisters loaded with CSNF, under normal and potential off-normal conditions. The results of the calculations are used to establish criticality safety design criteria, and to identify design and process parameters that are important to the criticality safety of the TAD canister-based systems in all surface and sub-surface facilities, with the exception of the WHF pool and the IHF.

For all calculations documented a prescriptive method (Section 6.3) has been applied to ensure that the configurations analyzed clearly bound those representative of normal conditions, and provide sufficient information to establish trends and to determine control parameters and their limits for off-normal conditions.

A significant number of the criticality safety calculations documented pertain to the examination of off-normal conditions. For these cases, the analysis approach is to comprehensively characterize the system behavior and response to changes in important parameters, such as geometry, moderation and neutron absorber. This systematic approach results in a very large parametric study but is important in that it affords an in-depth understanding of the system

behavior and sensitivity to single and multi-parameter perturbations, that is not achieved with a case-specific end state evaluation.

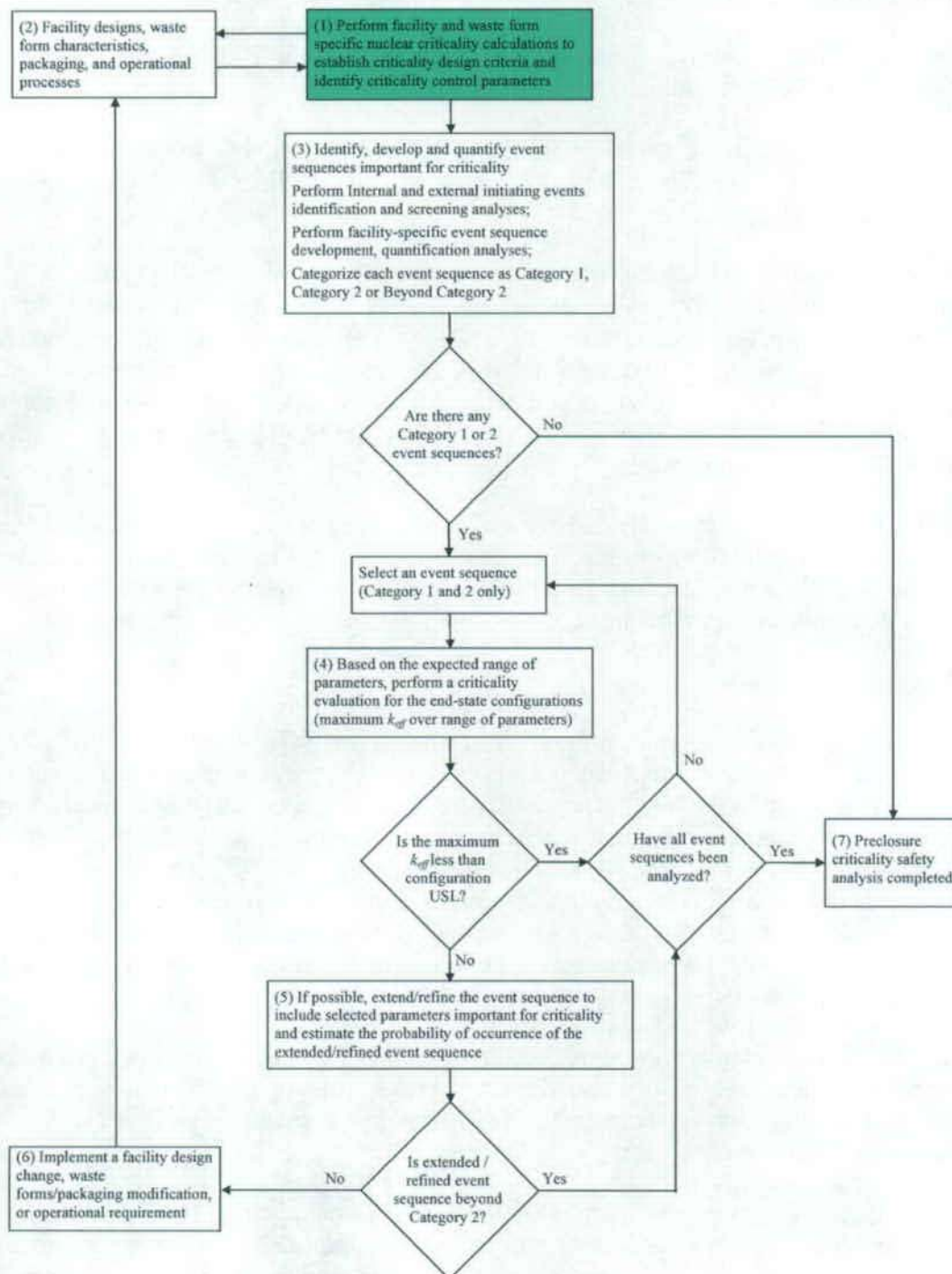

Source: Ref. 2.1.3

Figure 1. Preclosure Criticality Safety Process Flow Diagram

5. LIST OF ATTACHMENTS

Attachment #	Title	Number of Pages
I	Potential Off-Normal Scenario 1 Results	7
II	Potential Off-Normal Scenario 2 Results	12
III	Potential Off-Normal Scenario 3 Results	10
IV	Attachment Digital Video Disc Listing	2
V	Attachment Digital Video Disc	N/A

6. BODY OF CALCULATION

This section provides a detailed description of the TAD canister-based systems, describes their representation in the criticality safety models, and defines the criticality safety analysis method used to establish the conditions under which the TAD canister-based systems remain safely subcritical. The following structure is used:

- Section 6.1 outlines the design of the TAD canister-based systems;
- Section 6.2 explains how the TAD canister-based systems are represented in the criticality safety calculation models; and
- Section 6.3 presents the calculation method used to evaluate the criticality safety performance of the TAD canister-based systems under normal and potential off-normal conditions.

6.1 DESCRIPTION OF THE TAD CANISTER

The TAD canister is a welded cylindrical structure with flat ends. Internally, the TAD canister consists of a fuel basket that serves to provide a series of geometrically fixed and ordered (i.e. equally spaced) compartments into which CSNF assemblies are loaded. The basket structure is constructed of structurally competent material with incorporated neutron absorber, the design of which is important for criticality safety control.

The TAD canisters consist of two basic variants; a PWR variant and a BWR variant. Each variant conforms to the same dimensional envelope (i.e. the TAD diameters are identical) but differ in their internal basket structure. This distinction is primarily due to the differing payload of the two TAD variants; i.e. 21 PWR CSNF assemblies and 44 BWR CSNF assemblies, for the PWR and BWR TAD variants, respectively.

The TAD canisters are to be loaded and sealed with CSNF at the commercial reactor sites. However, provision exists to perform loading/sealing functions within the WHF due to the need to repackage CSNF that is delivered from reactor sites within a DPC or transportation cask, and to provide the capability to perform remediation work, where necessary.

6.1.1 Design Criteria

The *Transportation, Aging and Disposal Canister System Performance Specification* (Ref. 2.2.6, pg. 8 & 15) stipulates basic design criteria for TAD canister-based systems. The criteria pertinent to criticality safety are summarized below:

1. TAD OD of 66.5" $\left(\begin{array}{c} + 0.0'' \\ - 0.5'' \end{array} \right)$

2. TAD height of 212.0" $\left(\begin{array}{c} + 0.0'' \\ - 0.5'' \end{array} \right)$
3. The maximum capacities of the PWR and BWR TAD canisters shall be either 21 PWR CSNF assemblies or 44 BWR CSNF assemblies.
4. TAD cavity basket design shall feature borated stainless steel neutron absorber panels which conform to the following specification:
 - a. Have a minimum thickness of 0.433" (1.1 cm);
 - b. Multiple plates may be used if corrosion assumptions (250 nm/year) are taken into account for all surfaces such that 6 mm remains after 10,000 years;
 - c. Have a boron content within the range 1.1 weight percent (wt.%) to 1.2 wt.%;
 - d. Extend the full length of the active fuel region inclusive of any axial shifting of the assemblies within the TAD canister; and
 - e. Envelope all four longitudinal sides of each fuel assembly compartment.

Other pertinent, but less important to criticality safety, criteria include:

1. The use of Type 300-series stainless steel for the construction of the TAD, including the basket structure, but excluding neutron absorbing materials associated with the basket structure; and
2. Prohibiting the use of organic or hydrocarbon based materials in the TAD construction.

6.2 CRITICALITY SAFETY ANALYSIS MODEL

Using the design criteria outlined in Section 6.1.1, two base MCNP models are generated to represent PWR and BWR TAD design configurations that comply with the basic design criteria (Section 6.1.1). There are two basic components to the criticality safety models. The two basic components comprise the TAD canister and the CSNF assemblies associated with the TAD canister. A description of each component is provided in sub-sections 6.2.1.1 and 6.2.1.2, respectively. Materials employed for the two base MCNP models are detailed separately in Sub-section 6.2.2.

6.2.1 Model Geometry

6.2.1.1 TAD Canister Model Geometry

6.2.1.1.1 PWR TAD Canisters

The design parameters used for the PWR TAD canister criticality safety model are summarized in Table 5. For ease of comparison, the basic design criteria (Section 6.1.1) are also detailed. Cross-section illustrations of the PWR TAD canister criticality safety model are provided in Figure 2 through Figure 5.

From Table 5 it is seen that design parameters additional to those specified as design criteria *Transportation, Aging, and Disposal Canister System Performance Specification* (Ref. 2.2.6, pg. 8 & 15) are provided. The additional parameters are necessary in order to construct the MCNP model of the TAD canister. The nominal values assumed for these parameters reflect typical design practices for PWR CSNF transportation packages and are considered appropriate for this analysis. (Assumption 3.1.2 details of assumed values).

The majority of the parameters listed in Table 5 that do not have specific design criteria are those parameters relating to the thickness of the canister wall, base, lid, and the canister height. However, the value used for these parameters in the analysis of the criticality safety performance of the TAD canister system is relatively unimportant. For example, the examination of a wide variety of full-thickness (i.e. 30 cm) close fitting reflectors in the criticality safety analysis (Section 6.3) ensures that deviations between the 'actual' and 'modeled' TAD thickness is inconsequential. In addition, deviations between the 'actual' and 'modeled' canister height will not impact the conclusions of the analysis because the reactivity of the system is driven by the active fuel region, which is modeled with a conservative length in the calculations (Section 6.2.1.2).

The minority of the parameters listed in Table 5 that do not have specific design criteria are those parameters related to the fuel compartment width and wall design, in addition to the spacing between adjacent compartments. The values used for these parameters can have a strong influence on the criticality safety performance of the TAD canister-based system. In particular, the fuel compartment inner width and the spacing between adjacent compartments are important components of the criticality safety design, especially for potential off-normal conditions involving moderator entrainment into the canister cavity. Because these parameters directly influence the criticality safety performance of the canister system, their values have been selected to minimize this sensitivity, as should be the case when designing a CSNF transportation canister. Minimization of sensitivity in this case results in maximizing spacing between adjacent compartments, which provides for a maximum possible flux trap gap (and thus maximum effectiveness of the neutron absorber). Nevertheless, the off-normal scenarios evaluated (Section 6.3.2) consider progressive collapse of the compartment-compartment spacing (i.e. flux trap gap), and therefore provide an understanding of the system sensitivity to a range of compartment-compartment spacing.

Table 5. Design Parameters Evaluated for the PWR TAD Canister MCNP Model

Design Parameter	MCNP Model		Design Criteria
<i>TAD body</i>			
Inner diameter of TAD canister	65.0"	165.10 cm	No specific criteria
Outer length/height of TAD canister ^b	211.5"	537.21 cm	211.5" (min), 212.0" (max)
TAD spacer ^b	Not Modeled		Required for TAD Canisters less than 211.5" in height.
Inner length/height of TAD canister	210.5"	534.67 cm	No specific criteria
TAD base thickness	0.5"	1.27 cm	No specific criteria
TAD lid thickness	0.5"	1.27 cm	No specific criteria
<i>TAD basket structure</i>			
Inner width of fuel assembly compartment	9.0"	22.86 cm	No specific criteria
Compartment inner wall thickness	0.1875"	0.48 cm	No specific criteria
Compartment borated stainless steel panel arrangement ^c	Four panels around each compartment with a flux trap between		Panels must surround all four longitudinal sides of assemblies
Borated stainless steel panel thickness between adjacent fuel assemblies ^d	0.8 cm ((0.6 cm + (4 × 250 nm/yr × 10,000 yr)/2)		6 mm remaining after 10,000 yr with 250 nm/yr of corrosion for each surface
Basket height	Same as assembly height ^a		The BSS plates are required to cover the entire active fuel region plus an allowance for any axial shift in the fuel assemblies
Compartment outer wall thickness	0.1875"	0.48 cm	No specific criteria
Outer width of fuel assembly compartment	10.38"	26.37 cm	No specific criteria
Spacing between compartments (surface-to-surface) ^c	0.0" - 0.91"	0 - 2.32 cm	No specific criteria
Axial placement of fuel/basket in TAD ^a	Fuel/basket modeled to sit directly on the base of the TAD cavity		No specific criteria

NOTES: ^a The active fuel region and basket height are conservatively modeled equivalent to the fuel assembly height.

^b The provision of a TAD waste package 'spacer' is reserved for TAD canisters with external heights less than 211.5". The TAD waste package spacer is a feature that is external to the TAD canister and is not modeled in the criticality safety calculations.

^c The modeled canister basket structure design features a gap between adjacent fuel assembly compartments, commonly referred to as a flux trap gap. This arrangement is typical of CSNF canister designs and complies with the *Transportation, Aging and Disposal Canister System Performance Specification* (Ref. 2.2.6, pg. 8 & 15).

^d The provision of a flux trap gap results in two neutron absorber panels between adjacent assemblies. Accounting for 250 nm corrosion per year on each surface of the panels over a 10,000-year period results in a total thickness reduction of 10mm. Based on this corrosion allowance and a design specification of 8mm per panel, with two panels between adjacent assemblies, it is seen that a total thickness of 6mm is retained at 10,000 years.

Source: Original

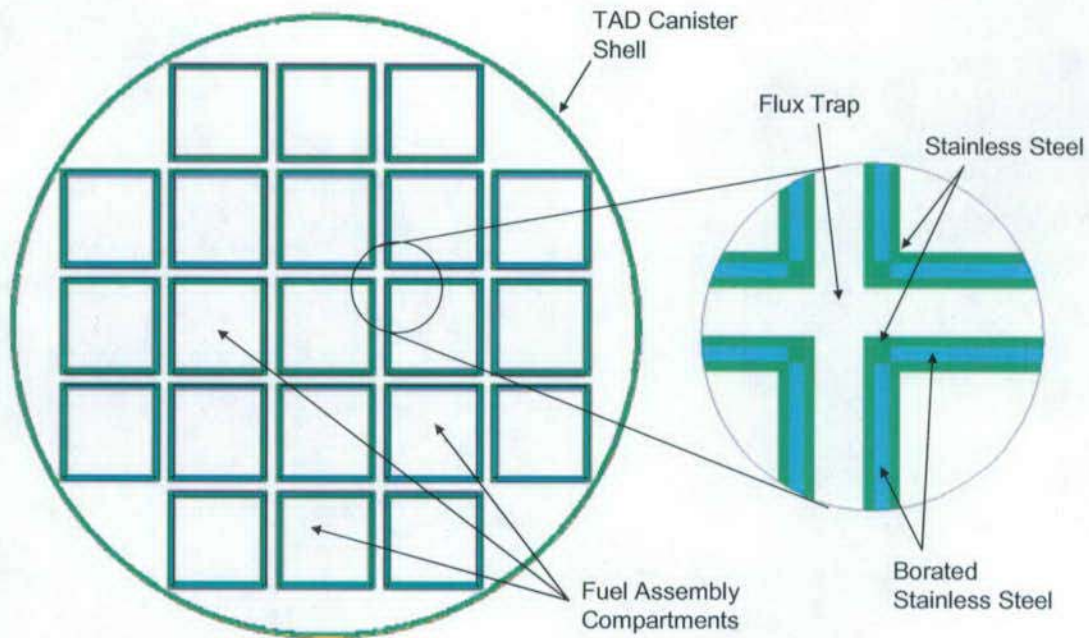

Source: Original

Figure 2: Radial Cross-Section of the PWR TAD Canister MCNP Model (Fuel Assemblies Not Illustrated)

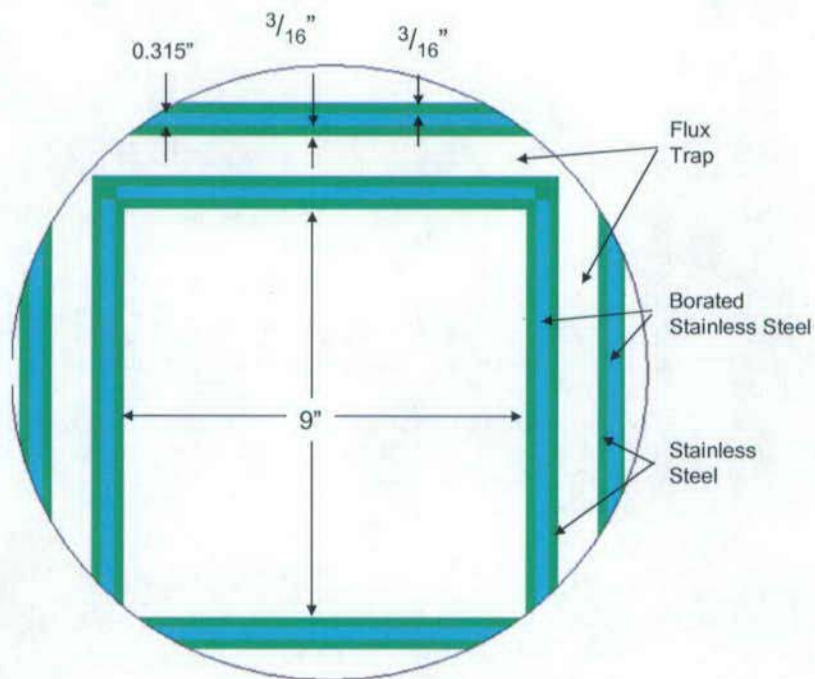

Source: Original

Figure 3: Expanded Radial Cross-Section of the PWR TAD Canister MCNP Model Showing a Fuel Compartment (Fuel Assembly Not Illustrated)

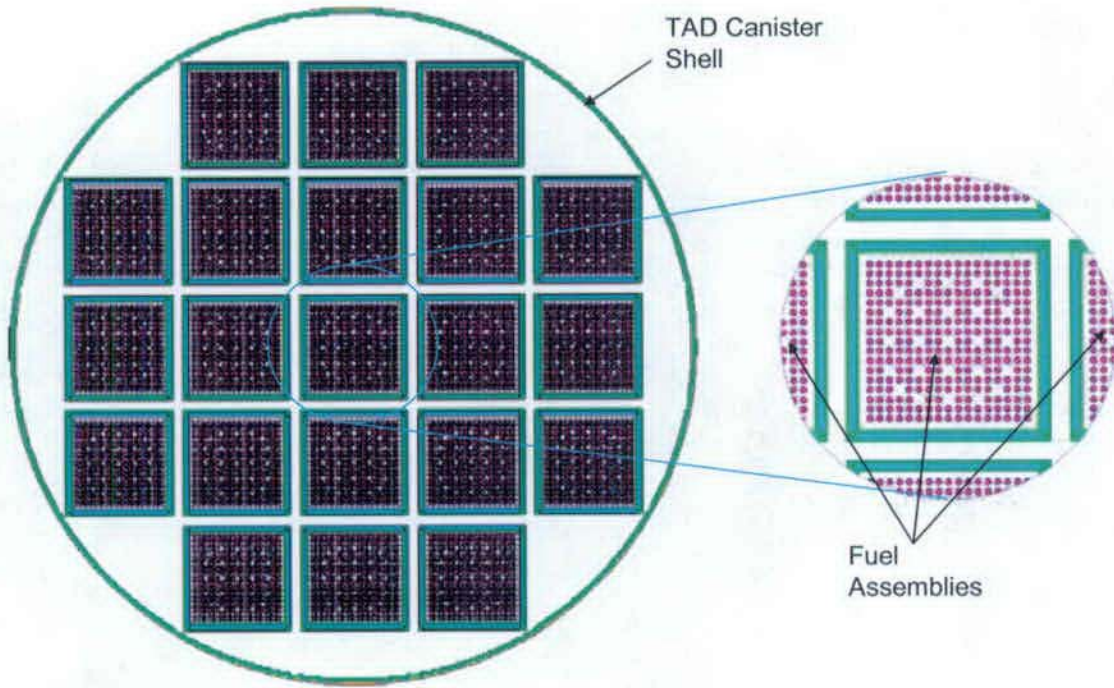

Source: Original

Figure 4. Radial Cross-Section of the PWR TAD Canister MCNP Model (Fuel Assemblies Illustrated)

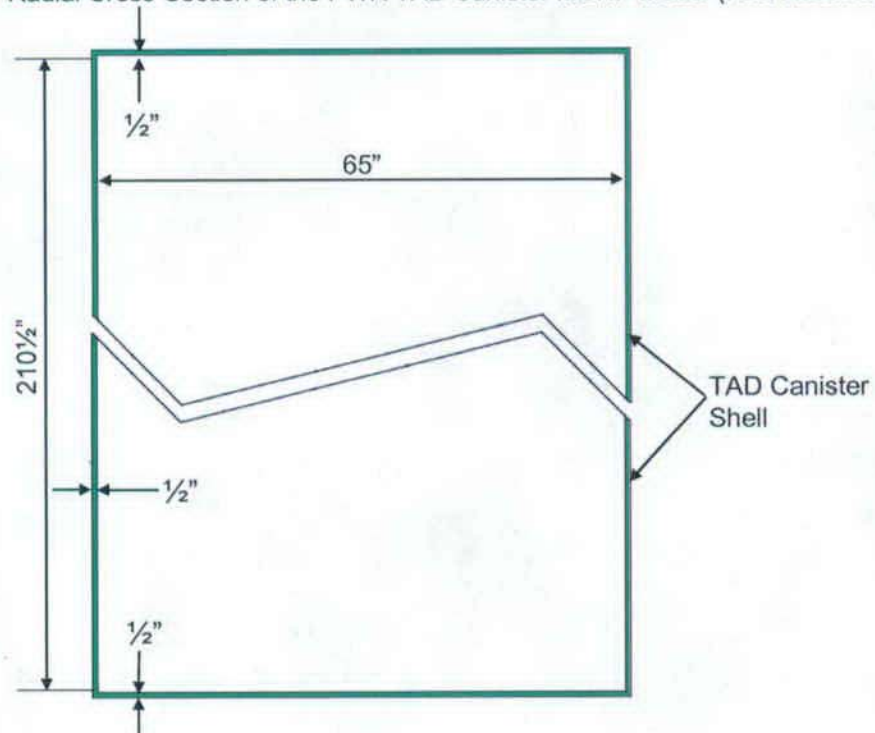

Source: Original

Figure 5. Axial Cross-Section of the PWR TAD Canister MCNP Model (Fuel Assemblies Not Illustrated)

6.2.1.1.2 BWR TAD Canisters

The design parameters used for the BWR TAD canister criticality safety model are summarized in Table 6. For ease of comparison, the basic design criteria (Section 6.1.1) are also detailed. Cross-section illustrations of the BWR TAD canister criticality safety model are provided in Figure 6 through Figure 9.

From Table 6 it is seen that design parameters additional to those detailed as design criteria *Transportation, Aging, and Disposal Canister System Performance Specification* (Ref. 2.2.6, pg. 8 & 15) are specified. Similar to the PWR TAD analysis, the nominal values considered for these parameters reflect typical design practices for BWR CSNF transportation packages and are considered appropriate for this analysis. Refer to the generic discussion provided for the PWR TAD canister (Section 6.2.1.1.1) and Assumption 3.1.2 for additional justification.

Table 6. Design Parameters Evaluated for the BWR TAD Canister MCNP Model

Design Parameter	MCNP Model		Design Criteria
<i>TAD body</i>			
Inner diameter of TAD canister	65.0"	165.10 cm	No specific criteria
Outer length/height of TAD canister ^b	211.5"	537.21 cm	211.5" (min), 212.0" (max)
TAD spacer ^b	Not modeled		Required for TAD Canisters less than 211.5" in height.
Inner length/height of TAD canister	210.5"	534.67 cm	No specific criteria
TAD base thickness	0.5"	1.27 cm	No specific criteria
TAD lid thickness	0.5"	1.27 cm	No specific criteria
<i>TAD basket structure</i>			
Inner width of fuel assembly compartment	6.0"	15.24 cm	No specific criteria
Compartment inner wall thickness	0.125"	0.32 cm	No specific criteria
Compartment borated stainless steel panel arrangement ^c	Four panels around each compartment with a flux trap between		Panels must surround all four longitudinal sides of assemblies
Borated stainless steel panel thickness between adjacent fuel assemblies ^d	0.8 cm ((0.6 cm + (4 × 250 nm/yr × 10,000 yr)/2)		6 mm remaining after 10,000 yr with 250 nm/yr of corrosion for each surface
Basket height	Same as assembly height ^a		The BSS plates are required to cover the entire active fuel region plus an allowance for any axial shift in the fuel assemblies
Compartment outer wall thickness	0.125"	0.32 cm	No specific criteria
Outer width of fuel assembly compartment	7.13"	18.11 cm	No specific criteria
Spacing between compartments (surface-to-surface) ^c	0.0" - 0.58"	0 - 1.48 cm	No specific criteria
Axial placement of fuel/basket in TAD ^a	Fuel/basket modeled to sit directly on the base of the TAD cavity		No specific criteria

NOTES: ^a The active fuel region and basket height are conservatively modeled equivalent to the fuel assembly height.

^b The provision of a TAD waste package 'spacer' is reserved for TAD canisters with external heights less than 211.5". The TAD waste package spacer is a feature that is external to the TAD canister and is not modeled in the criticality safety calculations.

^c The modeled canister basket structure design features a gap between adjacent fuel assembly compartments, commonly referred to as a flux trap gap. This arrangement is typical of CSNF canister designs and complies with the *Transportation, Aging and Disposal Canister System Performance Specification* (Ref. 2.2.6, pg. 8 & 15).

^d The provision of a flux trap gap results in two neutron absorber panels between adjacent assemblies. Accounting for 250nm corrosion per year on each surface of the panels over a 10,000-year period results in a total thickness reduction of 10mm. Based on this corrosion allowance and a design specification of 8mm per panel, with two panels between adjacent assemblies, it is seen that a total thickness of 6mm is retained at 10,000 years.

Source: Original

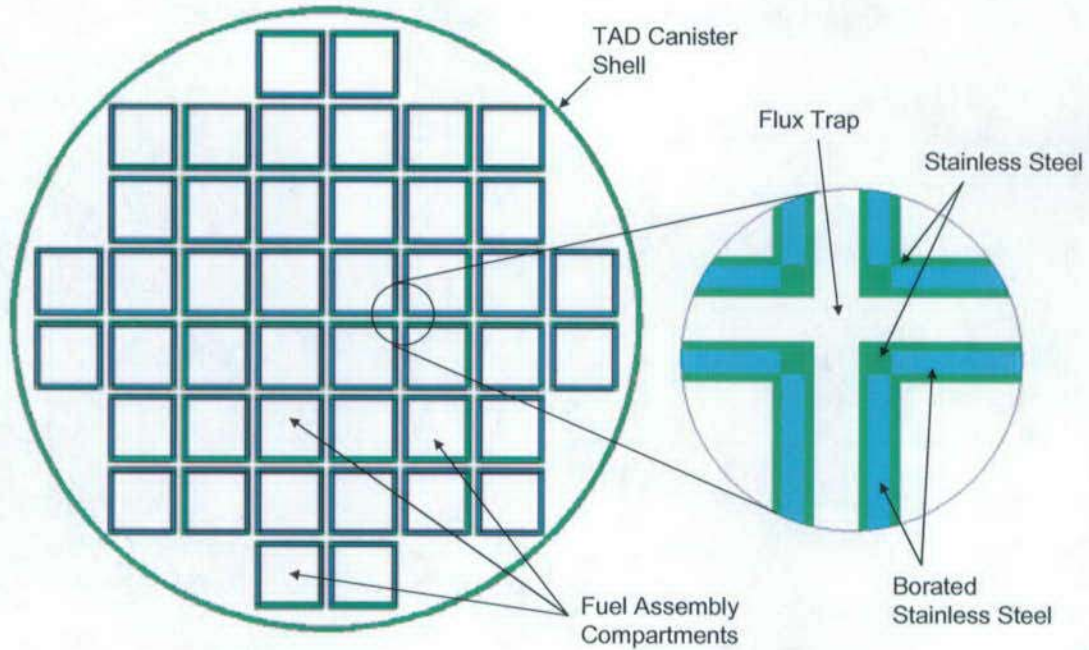

Source: Original

Figure 6. Radial Cross-Section of the BWR TAD Canister MCNP Model (Fuel Assemblies Not Illustrated)

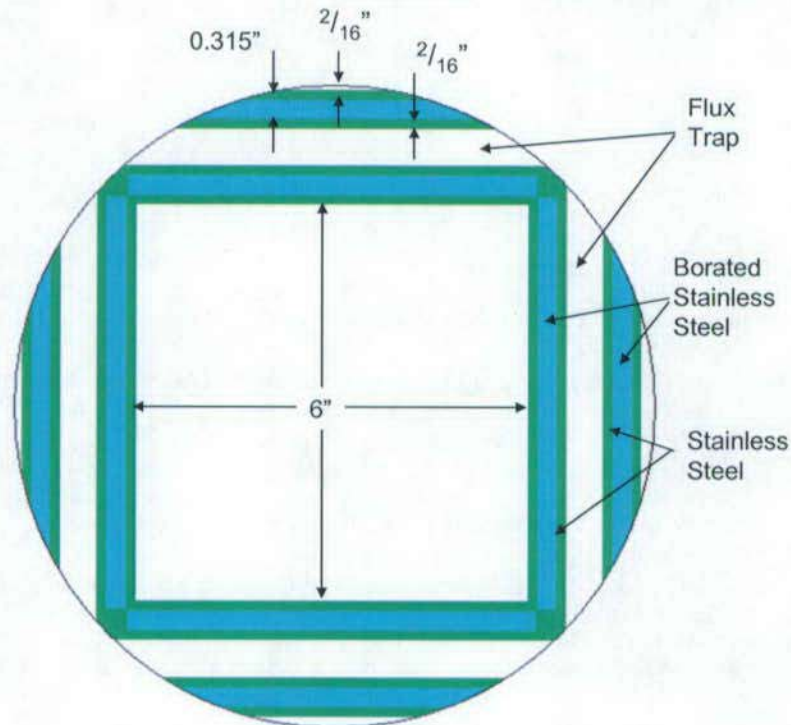

Source: Original

Figure 7. Expanded Radial Cross-Section of the BWR TAD Canister MCNP Model Showing a Fuel Compartment (Fuel Assembly Not Illustrated)

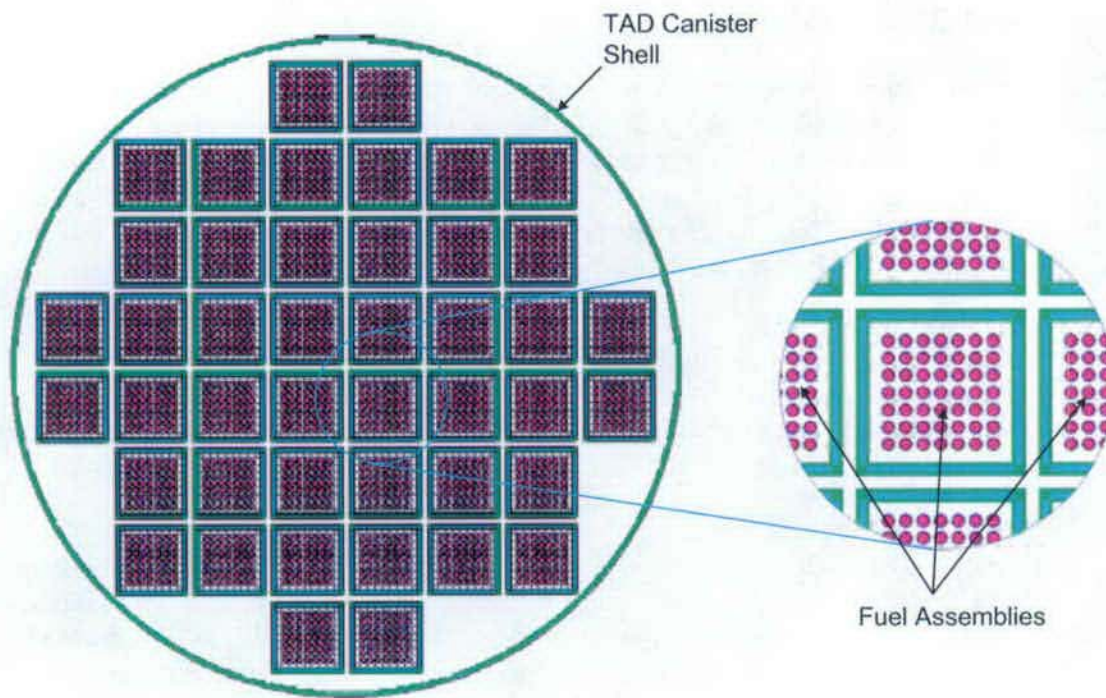

Source: Original

Figure 8. Radial Cross-Section of the BWR TAD Canister MCNP Model (Fuel Assemblies Illustrated)

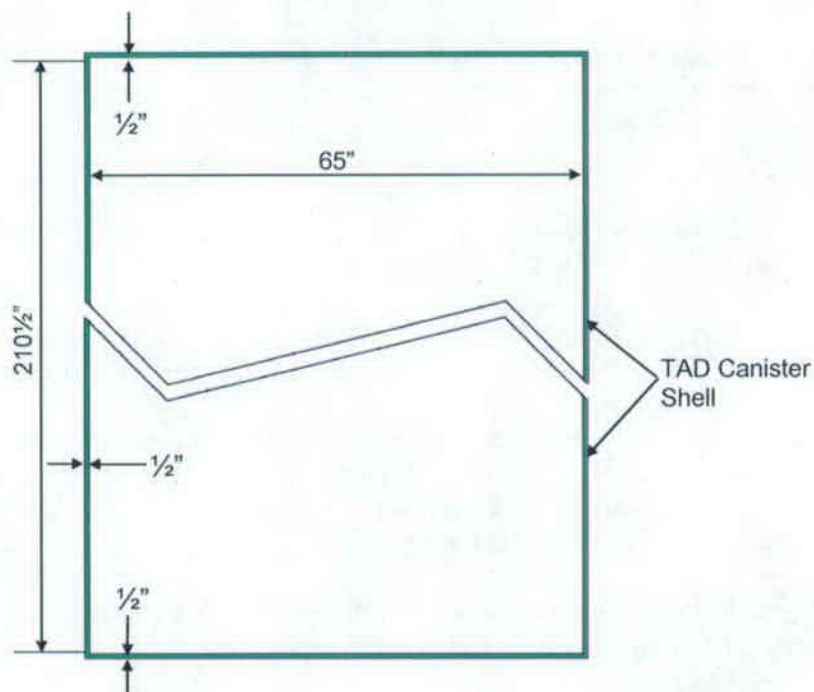

Source: Original

Figure 9:. Axial Cross-Section of the BWR TAD Canister MCNP Model (Fuel Assemblies Not Illustrated)

6.2.1.2 CSNF Model Geometry

All CSNF assemblies received, handled and emplaced within the Subsurface facility are limited to a maximum initial enrichment of 5 wt% $^{235}\text{U}/\text{U}$. A wide variety of CSNF assemblies will be accepted that meet this primary requirement. All CSNF assemblies will consist of light water reactor (LWR) fuel, comprising two variants; PWR fuel and BWR fuel. The geometric design of the PWR and BWR fuel assemblies evaluated in this document are described in this section. Materials associated with the fuel assemblies modeled are documented in Section 6.2.2.2.

6.2.1.2.1 PWR CSNF Assemblies

The criticality safety demonstration of the PWR TAD canister-based system is based on a full complement of 21 Westinghouse 17x17 OFA, under both normal conditions and potential off-normal conditions.

The Westinghouse 17x17 OFA selected for evaluation is considered representative of the broader PWR CSNF assembly population. Modeling techniques and conservatisms employed in the criticality safety analysis (Section 6.3) minimize the potential for realization of a more reactive condition, resultant from consideration of an alternate assembly design. In particular:

- The fuel assembly models are simplified by modeling only fuel, clad, guide, and instrument tube regions (i.e. non fuel structures and components such as spacer grids and end fittings are neglected in the model);
- The active fuel region is represented by a simple cylinder of fuel with the same diameter as the fuel pellet. The density is not modified to account for any dished ends to the pellets. This modeling treatment adds a small amount of additional fissile material to the system;
- The small gap between the outside of the fuel and the inside of the fuel cladding is explicitly modeled and filled with water;
- The active fuel region is conservatively assumed to encompass the entire axial extent of the fuel assembly (i.e. the non-fuel ends of the assembly are modeled as fuel);
- The fuel assembly are modeled with an initial enrichment equal to 5 wt% $^{235}\text{U}/\text{U}$, without crediting the presence of any burnable poisons, and ignoring the depletion of ^{235}U due to fuel burnup, as well as discounting the presence of fission products and higher actinides resultant from fuel irradiation; and
- The UO_2 fuel material density is conservatively modeled at a value of 10.751 g/cm^3 , which corresponds to 98% of the full theoretical density of UO_2 (10.97 g/cm^3 , *Handbook of Chemistry and Physics* (Ref. 2.2.11, page 4-97)).

In addition to conservative modeling practices, extensive sensitivity studies (Section 6.3.2) are performed to determine the susceptibility of evaluated criticality safety limits to pronounced changes in the analyzed canister system, including variations in CSNF design, such as variation

of pin pitch. While the intent of these sensitivity studies is to characterize system behavior under postulated damage conditions (such as fuel damage resultant from drop and deformation of a TAD canister), the evaluated data substantiates the expected relative insensitivity of the system to reasonable perturbations in the fuel assembly design.

The design parameters relevant to the Westinghouse 17x17 OFA are detailed in Table 7. The Westinghouse 17x17 OFA design is based on the description provided in *Dimension and Material Specification Selections for Use in Criticality Analyses* (Ref. 2.2.1), *Physical Descriptions of LWR Fuel Assemblies. Volume 3 of Characteristics of Spent Fuel, High-Level Waste, and Other Radioactive Wastes Which May Require Long-Term Isolation* (Ref. 2.2.9), and *Summary Report of Commercial Reactor Criticality Data for McGuire Unit 1* (Ref. 2.2.10).

Table 7. Basic Physical Parameters for the Westinghouse 17x17 OFA

Assembly Parameter	Westinghouse 17x17 OFA
Fuel rod pitch ^a (cm)	1.25984
Assembly width ^b (cm)	21.42236
Fuel pellet OD ^b (cm)	0.784352
Fuel rod OD ^a (cm)	0.9144
Fuel clad thickness ^a (cm)	0.05715
Assembly length ^b (cm)	405.8031
Guide tube OD ^a (cm)	1.20396 ^c
Guide tube wall thickness ^a (cm)	0.04064
Instrument tube OD ^a (cm)	1.20396
Instrument tube wall thickness ^a (cm)	0.04064

Source: ^a *Dimension and Material Specification for Use in Criticality Analyses* (Ref. 2.2.1, Table 71)

^b *Characteristics of Spent Fuel, High-Level Waste, and Other Radioactive Wastes Which May Require Long-Term Isolation* (Ref. 2.2.9, Appendix 2A, page 2A-11)

^c Two values for the guide tube OD are provided in *Dimension and Material Specification Selections for Use in Criticality Analyses* (Ref. 2.1.1). From Table 2-2 of *Summary Report of Commercial Reactor Criticality Data for McGuire Unit 1* (Ref. 2.2.10) the two values are for different heights in the core. The 1.20396 cm OD runs through ~311 cm of the active fuel region while the smaller 1.08966 cm OD portion runs through ~55 cm of the lower active fuel region. For modeling purposes these tubes are simply modeled as one diameter throughout the assembly at the value provided in the table.

The pin map used for the Westinghouse 17x17 OFA fuel assembly model is illustrated in Figure 10. The Westinghouse 17x17 OFA pin map is based on the *Summary Report of Commercial Reactor Criticality Data for McGuire Unit 1* (Ref. 2.2.10, Figure 2-3).

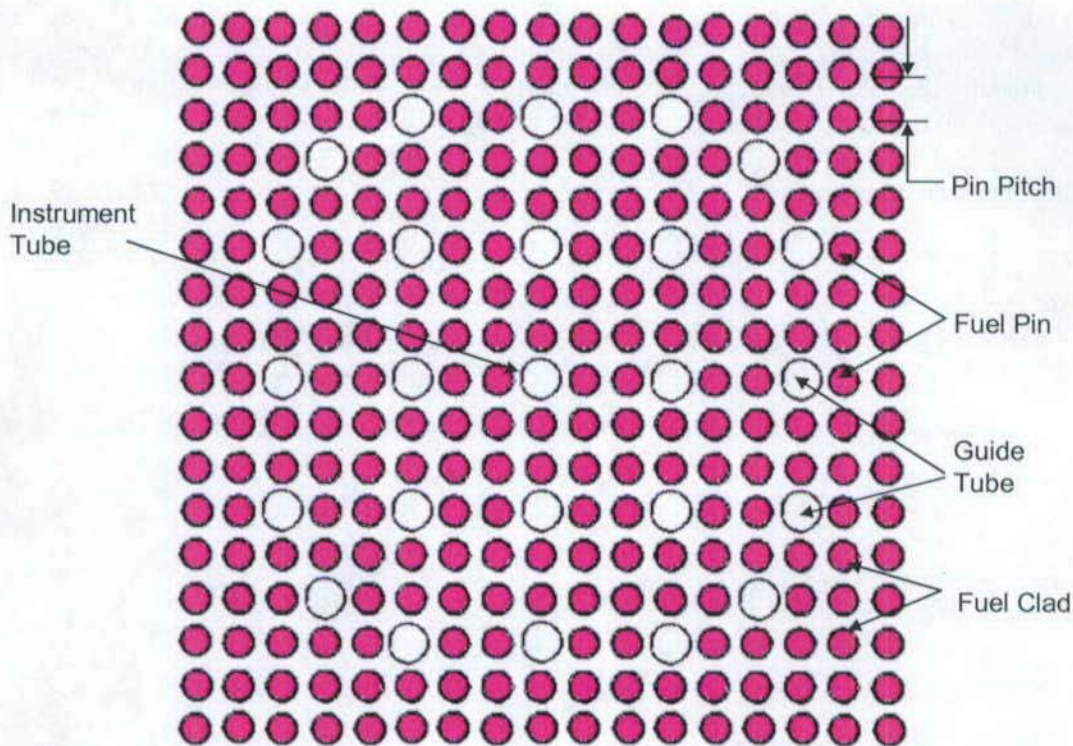

Source: Original

Figure 10. Cross-Section of the Westinghouse 17x17 OFA MCNP Model Showing Pin Map

6.2.1.2.2 BWR CSNF Assemblies

The criticality safety demonstration of the BWR TAD canister-based system is based on a full complement of 44 7x7 fuel assemblies, under both normal conditions and potential off-normal conditions.

The 7x7 fuel assembly selected for evaluation is considered representative of the broader BWR CSNF assembly population. Consistent with the PWR TAD canister analysis, modeling techniques and conservatisms employed in the criticality safety calculation ensure that other assembly designs will unlikely result in a more reactive condition (Section 6.2.1.2.1). In addition to the generic conservatisms, the fuel assembly shroud/channel is neglected in the MCNP models. This modeling treatment is conservative because it further reduces the quantity of non-fissile material in the model, which would otherwise provide some degree of parasitic neutron absorption. Furthermore, omission of the fuel assembly shroud/channel allows the fuel pins to achieve a larger, more reactive pitch, under potential off-normal conditions.

In common with the PWR TAD canister analysis, extensive sensitivity studies (Section 7) are performed to determine the susceptibility of evaluated criticality safety limits to pronounced changes in the analyzed canister system, including variations in CSNF design, such as variation of pin pitch. While the intent of these sensitivity studies is to characterize system behavior under postulated damage conditions (such as fuel damage resultant from drop and deformation of a

TAD canister), the evaluated data substantiates the expected relative insensitivity of the system to reasonable perturbations in the fuel assembly design.

The design parameters relevant to the 7x7 fuel assembly type are detailed in Table 8. The 7x7 fuel assembly design is based on the description provided in *Dimension and Material Specification Selections for Use in Criticality Analyses* (Ref. 2.2.1) and *Physical Descriptions of LWR Fuel Assemblies. Volume 3 of Characteristics of Spent Fuel, High-Level Waste, and Other Radioactive Wastes Which May Require Long-Term Isolation* (Ref. 2.2.9).

Table 8. Basic Physical Parameters for the BWR Fuel Assemblies

Assembly Parameter	7x7
Fuel rod pitch ^a (cm)	1.87452
Channel inner width ^a (cm)	13.246
Channel thickness ^a (cm)	0.3048
Fuel pellet OD ^a (cm)	1.23952
Fuel rod OD ^a (cm)	1.43002
Fuel clad thickness ^a (cm)	0.08128
Assembly length ^b (cm)	447.04
Water rod OD ^a (cm)	N/A
Water rod ID ^a (cm)	N/A

Source: ^a *Dimension and Material Specification for Use in Criticality Analyses* (Ref. 2.2.1, Table 71)

^b *Characteristics of Spent Fuel, High-Level Waste, and Other Radioactive Wastes Which May Require Long-Term Isolation* (Ref. 2.2.9, Appendix 2A, page 2A-12) as listed for the longest GE 7x7 FA

The pin map used for the 7x7 fuel assembly model is illustrated in Figure 11. The 7x7 fuel assembly pin map represents a uniform 7x7 array of fuel pins (49 in total), with no water rod positions.

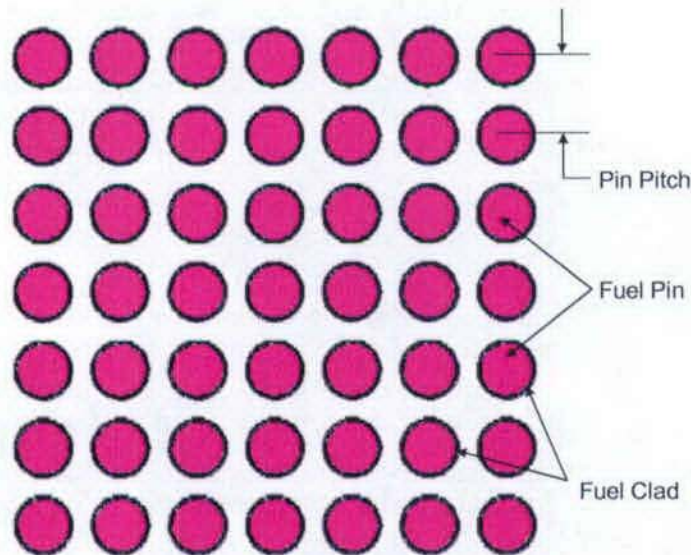

Source: Original

Figure 11: Cross-Section Illustration of the 7x7 Fuel Assembly Model Showing Pin Map

6.2.2 Materials Modeled

This section provides an overview of the materials that are modeled in the MCNP calculations performed in support of the criticality safety analysis of the PWR and BWR TAD canister systems. The following structure is used:

- Section 6.2.2.1 discusses the materials associated with the PWR and BWR TAD canister systems, as described in Section 6.2.1.1;
- Section 6.2.2.2 discusses the materials associated with the PWR and BWR CSNF assemblies, are described in Section 6.2.1.2; and
- Section 6.2.2.3 discusses the materials considered when evaluating the effect of structures and components surrounding the TAD canisters (e.g. casks, the facility floor, walls, equipment, etc).

The majority of the material specifications detailed in this Section is taken directly from *Dimension and Material Specification Selection for Use in Criticality Analyses* (Ref. 2.2.1). In respect of the material specification descriptions, the MCNP unique identifiers called ‘ZAIDs’, are provided. These identifiers generally contain the atomic number (Z), mass number (A), and data library specifier of the element or isotope of interest.

The material specifications for *borated stainless steel* and *SAR concrete* utilized the atomic weights, isotopic masses, and isotopic abundances (in atom percent) specified in *Nuclides and Isotopes* (Ref. 2.2.5), to expand the elemental weight percents into their constituent natural isotopic weight percents for use in the MCNP calculations. This expansion is performed by:

1. Calculating a natural weight fraction of each isotope in the elemental state, and
2. Multiplying the elemental weight percent in the material of interest by the natural weight fraction of the isotope in the elemental state, to obtain the weight percent of the isotope in the material of interest.

The abovementioned two step process is described mathematically in equations 5 and 6.

$$WF_i = \frac{A_i(At\%_i)}{\sum_{i=1}^I A_i(At\%_i)} \quad \text{(Equation 5)}$$

where

WF_i = the weight fraction of isotope i in the natural element

A_i = the atomic mass of isotope i

$At\%_i$ = the atom percent of isotope i in the natural element

I = the total number of isotopes in the natural element.

$$Wt\%_i = WF_i(E_{wt\%}) \quad \text{(Equation 6)}$$

where

$Wt\%_i$ = the weight percent of isotope i in the material composition

WF_i = the weight fraction of isotope i from Equation 5

$E_{wt\%}$ = the referenced weight percent of the element in the material composition.

The elements from material specifications that require separation into their constituent isotopes include boron, chromium, iron, and nickel. In most cases determination of the isotopic split is provided in the documentation from which the material specification is taken. In a number of cases (e.g., borated stainless steel and SAR concrete) determination of the isotopic split of the constituent elements is performed and described in this criticality safety analysis. In these limited cases, the atomic weight and natural isotopic abundance (based on the data contained in *Nuclides and Isotopes* (Ref. 2.2.5, pg. 40, 46 & 70)) is used for the isotopic split determination for each element. The relevant data is summarized in Table 9.

Table 9. Isotopic Abundances and Atomic Weights

Element/ Isotope	Natural Isotopic Abundance (atom %)	Atomic Weight (g/mol)
B	--	10.811
¹⁰ B	19.9	10.0129
¹¹ B	80.1	11.0093
Cr	--	51.9961
⁵⁰ Cr	4.345	49.946050
⁵² Cr	83.789	51.940512
⁵³ Cr	9.501	52.940654
⁵⁴ Cr	2.365	53.938885
Fe	--	55.845
⁵⁴ Fe	5.845	53.939615
⁵⁶ Fe	91.754	55.934942
⁵⁷ Fe	2.119	56.935399
⁵⁸ Fe	0.282	57.933280
Ni	--	58.6934
⁵⁸ Ni	68.0769	57.935348
⁶⁰ Ni	26.2231	59.930791
⁶¹ Ni	1.1399	60.931060
⁶² Ni	3.6345	61.928349
⁶⁴ Ni	0.9256	63.927970
²³⁵ U	0.72	235.043923
²³⁸ U	99.2745	238.050783

Source: *Nuclides and Isotopes*, Ref. 2.2.5, pg. 40, 46 & 70.

6.2.2.1 TAD Canister Materials

The TAD canister is described in Section 6.1. The *Transportation, Aging and Disposal Canister System Performance Specification* (Ref. 2.2.6, pg. 8) requires the use of Type 300-series stainless steel for the construction of the TAD. For the purpose of this analysis, 316 stainless steel (UNS S31600) is used as the material of construction of the TAD. The specification for 316 stainless steel provided in Table 10 is taken directly from *Dimension and Material Specification Selection for use in Criticality Analyses* (Ref. 2.2.1).

Table 10. Material Specification for 316 Stainless Steel

Element/Isotope	ZAID	Wt%	Element/Isotope	ZAID	Wt%
C-nat	6000.50c	0.0800	⁵⁴ Fe	26054.60c	3.7007
¹⁴ N	7014.50c	0.1000	⁵⁶ Fe	26056.60c	60.1884
Si-nat	14000.50c	0.7500	⁵⁷ Fe	26057.60c	1.4156
³¹ P	15031.50c	0.0450	⁵⁸ Fe	26058.60c	0.1902
³² S	16032.50c	0.0300	⁵⁸ Ni	28058.60c	8.0641
⁵⁰ Cr	24050.60c	0.7103	⁶⁰ Ni	28060.60c	3.2127
⁵² Cr	24052.60c	14.2291	⁶¹ Ni	28061.60c	0.1420
⁵³ Cr	24053.60c	1.6443	⁶² Ni	28062.60c	0.4596
⁵⁴ Cr	24054.60c	0.4162	⁶⁴ Ni	28064.60c	0.1216
⁵⁵ Mn	25055.50c	2.0000	Mo-nat	42000.50c	2.5000
Density = 7.98 g/cm ³					

Source: *Dimension and Material Specification for Use in Criticality Analyses* (Ref. 2.2.1, Table 5)

The *Transportation, Aging and Disposal Canister System Performance Specification* (Ref. 2.2.6, pg. 15) requires the use of 304B4 UNS S30464 borated stainless steel for use as neutron absorber plates. The material 304B4 UNS S30464 borated stainless steel specification is based on *Standard Specification for Borated Stainless Steel Plate, Sheet, and Strip for Nuclear Application* (Ref. 2.2.7 (Table 1)). The weight fraction of chromium and nickel are set to the mid-point of their stated range, whereas the value for nitrogen is set to the maximum value stated for its range (to maximize iron weight fraction).

The TAD canister design criteria (Section 6.1.1) specifies that the TAD canister internal structure shall incorporate borated stainless steel neutron absorber panels with a boron content within the range 1.1 wt.% to 1.2 wt.%. The lower limit of this range (i.e. 1.1 wt.%) is conservatively used in determining the final material specification for the borated stainless steel. This value is further reduced by 25% to 0.825 wt.% in recognition of the general requirement to take no more than 75% credit for fixed neutron absorbers in criticality safety evaluations (NUREG-1567, *Standard Review Plan for Spent Fuel Dry Storage Facilities* (Ref. 2.2.8)).

In determining the borated stainless steel density, a mixture of boron (2.35 g/cm³, *Nuclides and Isotopes* (Ref. 2.2.5, pg. 40)), 304 stainless steel (7.94 g/cm³ from Table 17), and void (to account for the 25% reduction in boron) is assumed. On this basis, the density of the borated steel with a 25% reduction in the boron is determined as follows;

$$\begin{aligned} \rho_{BSS} &= \frac{\left(\frac{g_B}{g_{BSS}} \times 0.75\right) + \left(\frac{g_{304}}{g_{BSS}}\right)}{\left(\frac{g_B}{g_{BSS}} \div \rho_B\right) + \left(\frac{g_{304}}{g_{BSS}} \div \rho_{304}\right)} \\ &= \frac{(0.011 \times 0.75) \frac{g_B}{g_{BSS}} + (1 - 0.011) \frac{g_{304}}{g_{BSS}}}{\left(\frac{0.011 \frac{g_B}{g_{BSS}}}{2.35 \frac{g_B}{cc}}\right) + \left(\frac{(1 - 0.011) \frac{g_{304}}{g_{BSS}}}{7.94 \frac{g_{304}}{cc}}\right)} \\ &= 7.716 \frac{g}{cc} \end{aligned}$$

where,

- ρ_{BSS} = the determined density for borated stainless steel
- g_B = grams boron
- g_{BSS} = grams borated stainless steel
- g_{304} = grams 304 stainless steel
- ρ_B = the density of boron
- ρ_{304} = the density for 304 stainless steel.

For boron, chromium, iron, and nickel, the isotopic cross-sections versus a combined elemental cross-section are utilized. The material specification for borated stainless steel from *Standard Specification for Borated Stainless Steel Plate, Sheet, and Strip for Nuclear Application* (Ref. 2.2.7) provides only elemental weight percents. The weight percents of the isotopes of boron, chromium, iron, and nickel are determined based upon the information given in Table 9 and Equations 5 and 6. The derived specification for borated stainless steel used in this calculation is provided in Table 11.

Table 11. Material Specification for Borated Stainless Steel

Element/Isotope	ZAID	Wt%	Element/Isotope	ZAID	Wt%
B	N/A	0.825	⁵⁵ Mn	25055.50c	2.0000
¹⁰ B	5010.50c	0.1521	Fe	N/A	62.675
¹¹ B	5011.50c	0.6729	⁵⁴ Fe	26054.60c	3.5384
C-nat	6000.50c	0.0800	⁵⁶ Fe	26056.60c	57.5994
¹⁴ N	7014.50c	0.1000	⁵⁷ Fe	26057.60c	1.3540
Si-nat	14000.50c	0.7500	⁵⁸ Fe	26058.60c	0.1834
³¹ P	15031.50c	0.0450	Ni	N/A	13.5
³² S	16032.50c	0.0300	⁵⁸ Ni	28058.60c	9.0717
Cr	N/A	19.0	⁶⁰ Ni	28060.60c	3.6148
⁵⁰ Cr	24050.60c	0.7930	⁶¹ Ni	28061.60c	0.1598

Element/Isotope	ZAID	Wt%	Element/Isotope	ZAID	Wt%
⁵² Cr	24052.60c	15.9029	⁶² Ni	28062.60c	0.5177
⁵³ Cr	24053.60c	1.8380	⁶⁴ Ni	28064.60c	0.1361
⁵⁴ Cr	24054.60c	0.4661	Density = 7.716 g/cm ³		

NOTES: The total wt% is 99.725 versus 100% due to reduced boron content. This maintains the correct relative amounts. MCNP will automatically re-ratio these values to total 100%.

Source: *Standard Specification for Borated Stainless Steel Plate, Sheet, and Strip for Nuclear Application* (Ref. 2.2.7, Table 1) except for the determined/modified values as discussed above.

6.2.2.2 CSNF Assembly Materials

The criticality safety analysis of the TAD canister-based systems employs highly conservative modeling techniques (Section 6.3), when evaluating the performance of the TAD canisters in off-normal conditions. The principal modeling techniques and conservatisms that are relevant to the fuel assembly design considered in the MCNP calculations include:

- Simplification of the fuel assembly model by considering only fuel, clad, guide, and instrument tube regions (i.e. non fuel structures and components such as spacer grids and end fittings are neglected in the model);
- Neglecting the inactive fuel region at the axial extremities of the fuel assembly, i.e. the fuel region is conservatively assumed to encompass the entire axial extent of the fuel assembly;
- The fuel assembly are modeled with an initial enrichment equal to 5 wt% ²³⁵U/U, without crediting the presence of any burnable poisons, and ignoring the depletion of ²³⁵U due to fuel burnup, as well as discounting the presence of fission products and higher actinides resultant from fuel irradiation;
- The UO₂ fuel material density is conservatively modeled at a value of 10.751 g/cm³, which corresponds to 98% of the full theoretical density of UO₂ (10.97 g/cm³, *Handbook of Chemistry and Physics* (Ref. 2.2.11, page 4-97)).

Based on the above methodology, the fuel assembly materials included in the MCNP models consist of the fuel and the fuel clad only.

The criticality safety demonstration of the PWR TAD canister-based system is based on a full complement of 21 Westinghouse 17x17 OFA. The Westinghouse 17x17 OFA fuel cladding material is specified as Zircaloy-4 in Volume 3 of *Characteristics of Spent Fuel, High-Level Waste, and Other Radioactive Wastes Which May Require Long-Term Isolation* (Ref. 2.2.9, Appendix 2A, page 2A-345). The instrument/guide tube material is listed as Zircaloy in the *Summary Report of Commercial Reactor Criticality Data for McGuire Unit 1* (Ref. 2.2.10, Table 2-2). Since there is little difference between the atomic structure of the various Zircaloy cladding materials, and recognizing that the property of effective cladding material is to exhibit strong transparency to neutrons, the Zircaloy material for the instrument tube of the Westinghouse 17x17 OFA is modeled as Zircaloy-4.

The criticality safety demonstration of the BWR TAD canister-based system is based on a full complement of 44 7x7 fuel assemblies. The fuel cladding and channel material for the 7x7 fuel assembly is specified as Zircaloy-2 in *Dimension and Material Specification Selection for Use in Criticality Analyses* (Ref. 2.2.1, Tables 73 and 74), although the fuel channel is conservatively neglected in the MCNP models (Section 6.2.1.2.2).

The atom weight fractions modeled for the UO₂ fuel region in the MCNP models are derived consistent with the method provided below, and are summarized in

Table 14. In respect of this method, the atomic weights used for the component isotopes are based on the data contained in *Nuclides and Isotopes* (Ref. 2.2.5, pg. 70).

The molecular weight of UO₂ is determined as follows;

$$\begin{aligned} AM_{5\%U} &= \frac{1}{\frac{wf_{235U}}{MW_{235U}} + \frac{wf_{238U}}{MW_{238U}}} \\ &= \frac{1}{\frac{0.05}{235.043923} + \frac{0.95}{238.050783}} \\ &= 237.8986 \\ MW_{UO_2} &= AM_{5\%U} + (2 \times AM_O) \\ &= 237.8986 + (2 \times 15.9994) \\ &= 269.8974 \frac{g}{mol} \end{aligned}$$

where,

$AM_{5\%U}$ = atomic mass of uranium enriched to 5 wt% ²³⁵U

MW_{UO_2} = molecular weight UO₂

wf_{235U} = isotopic weight fraction of ²³⁵U in U

AM_{235U} = atomic mass of ²³⁵U

wf_{238U} = isotopic weight fraction of ²³⁸U in U

AM_{238U} = atomic mass of ²³⁸U

AM_O = atomic mass of oxygen

The weight percents of the various fuel components are;

$$\begin{aligned} \text{Wt}\%_{235\text{U}} &= \frac{\text{wf}_{235\text{U}} \times \text{AM}_{5\%U}}{\text{MW}_{\text{UO}_2}} \times 100 \\ &= \frac{0.05 \times 237.8986}{269.8974} \times 100 \\ &= 4.4072 \end{aligned}$$

$$\begin{aligned} \text{Wt}\%_{238\text{U}} &= \frac{\text{wf}_{238\text{U}} \times \text{AM}_{5\%U}}{\text{MW}_{\text{UO}_2}} \times 100 \\ &= \frac{0.95 \times 237.8986}{269.8974} \times 100 \\ &= 83.7369 \end{aligned}$$

$$\begin{aligned} \text{Wt}\%_{\text{O}} &= \frac{2 \times \text{AM}_{\text{O}}}{\text{MW}_{\text{UO}_2}} \times 100 \\ &= \frac{2 \times 15.9994}{269.8974} \times 100 \\ &= 11.8559 \end{aligned}$$

Table 12. Material Specification for Zircaloy-2

Element/Isotope	ZAID	Wt%	Element/Isotope	ZAID	Wt%
50Cr	24050.60c	0.0042	58Ni	28058.60c	0.0370
52Cr	24052.60c	0.0837	60Ni	28060.60c	0.0147
53Cr	24053.60c	0.0097	61Ni	28061.60c	0.0007
54Cr	24054.60c	0.0024	62Ni	28062.60c	0.0021
54Fe	26054.60c	0.0076	64Ni	28064.60c	0.0006
56Fe	26056.60c	0.1241	16O	8016.50c	0.1250
57Fe	26057.60c	0.0029	Zr-nat	40000.60c	98.1350
58Fe	26058.60c	0.0004	Sn-nat	50000.35c	1.4500
Density = 6.55 g/cm3					

Source: *Dimension and Material Specification for Use in Criticality Analyses* (Ref. 2.2.1, Table 11)

Table 13. Material Specification for Zircaloy-4

Element/Isotope	ZAID	Wt%	Element/Isotope	ZAID	Wt%
50Cr	24050.60c	0.0042	57Fe	26057.60c	0.0045
52Cr	24052.60c	0.0837	58Fe	26058.60c	0.0006
53Cr	24053.60c	0.0097	16O	8016.50c	0.1250
54Cr	24054.60c	0.0024	Zr-nat	40000.60c	98.1150
54Fe	26054.60c	0.0119	Sn-nat	50000.35c	1.4500
56Fe	26056.60c	0.1930	Density = 6.56 g/cm ³		

Source: *Dimension and Material Specification for Use in Criticality Analyses* (Ref. 2.2.1, Table 10)

Table 14. Material Specification for UO₂ (5 wt.% ²³⁵U Enriched U)

Isotope	ZAID	Wt%
²³⁵ U	92235.50c	4.4072
²³⁸ U	92238.50c	83.7369
¹⁶ O	8016.50c	11.8559
Density = 10.751 g/cm ³ (Section 3.2.1).		

6.2.2.3 External Materials

The handling, staging, and emplacement of the TAD canisters results in their positioning within close proximity to, or in contact with, a wide variety of structures and components, such as transportation casks, the waste package, the facility floor and walls, the volcanic tuff associated with the emplacement drifts, etc. To bound the wide range of reflection conditions that could credibly exist, the MCNP models described in Section 6.3 feature a variety of close fitting full-thickness (i.e. 30 cm) reflectors (refer to Figure 12 through Figure 14 for illustration).

The reflector materials considered in the criticality safety analysis of the TAD canister systems are described in the following sub-sections. The reflector materials provided have been selected cognizant of the materials that could be present during handling, staging and emplacement of TAD canister systems in all surface and sub-surface facilities, with the exception of the WHF pool, which is specifically addressed elsewhere. The reflector materials selected have been limited to those materials that possess atomic characteristics, and exist in significant quantities, to provide a meaningful degree of neutron reflection.

6.2.2.3.1 Water

Water (H₂O), when modeled as a neutron reflector, is treated at full theoretical density (0.99821 g/cm³) in the TAD canister MCNP calculations. The specification for water, based on water at 20° C (*Handbook of Chemistry and Physics* (Ref. 2.2.11, page 6-2)), is provided in Table 15.

Table 15. Water Material Specification

Element/ Isotope	ZAID	Atoms per Molecule
¹ H	1001.50c	2
¹⁶ O	8016.50c	1
Density: 0.99821 g/cm ³		

6.2.2.3.2 Concrete

Numerous detailed concrete compositions are available and some of the most common were evaluated in *Dimension and Material Specification for Use in Criticality Analyses* (Ref. 2.2.1). The results demonstrate that the differing compositions have a statistically insignificant effect on the calculated neutron multiplication factor when evaluated for similar systems. Therefore, a single concrete material specification is used for the TAD canister criticality safety analysis. The material specification selected is *SAR concrete*, which has a material composition defined in *Dimension and Material Specification for Use in Criticality Analyses* (Ref. 2.2.1). The *SAR concrete* specification does not include an isotopic breakdown for iron. Therefore, an isotopic distribution for iron is established, based on the data provided in Table 9. The amended SAR concrete material specification is provided in Table 16.

Table 16. Material Specifications for SAR Concrete

Element/ Isotope	ZAID	Wt%	Element/ Isotope	ZAID	Wt%
1H	1001.50c	0.6	Fe-nat	N/A	1.2
16O	8016.50c	50.0	54Fe	26054.60c	0.0316
23Na	11023.50c	1.7	56Fe	26056.60c	0.5142
27Al	13027.50c	0.480	57Fe	26057.60c	0.0121
Si-nat	14000.50c	31.5	58Fe	26058.60c	0.0016
K-nat	19000.50c	1.90	Density = 2.35 g/cm ³		
Ca-nat	20000.50c	8.30			

Source: *Dimension and Material Specification for Use in Criticality Analyses* (Ref. 2.2.1, Table 56)

6.2.2.3.3 Steel

Steel, when modeled as a neutron reflector, is treated as *304 Stainless Steel* in the TAD canister MCNP calculations. The specification for 304 Stainless Steel is based on the specification provided in *Dimension and Material Specification for Use in Criticality Analyses* (Ref. 2.2.1), where it is designated as *SA-240 S30400*. The specification for 304 Stainless Steel used in the TAD canister criticality safety analysis is detailed in Table 17.

Table 17. Material Specification for 304 Stainless Steel

Element/Isotope	ZAID	Wt%	Element/Isotope	ZAID	Wt%
C-nat	6000.50c	0.0800	⁵⁴ Fe	26054.60c	3.8844
¹⁴ N	7014.50c	0.1000	⁵⁶ Fe	26056.60c	63.1751
Si-nat	14000.50c	0.7500	⁵⁷ Fe	26057.60c	1.4859
³¹ P	15031.50c	0.0450	⁵⁸ Fe	26058.60c	0.1997
S-nat	16032.50c	0.0300	⁵⁸ Ni	28058.60c	6.2161
⁵⁰ Cr	24050.60c	0.7939	⁶⁰ Ni	28060.60c	2.4765
⁵² Cr	24052.60c	15.9031	⁶¹ Ni	28061.60c	0.1095
⁵³ Cr	24053.60c	1.8378	⁶² Ni	28062.60c	0.3543
⁵⁴ Cr	24054.60c	0.4652	⁶⁴ Ni	28064.60c	0.0937
⁵⁵ Mn	25055.50c	2.0000	Density = 7.94 g/cm ³		

Source: *Dimension and Material Specification for Use in Criticality Analyses* (Ref. 2.2.1, Table 12)

6.2.2.3.4 Depleted Uranium

Depleted uranium is uranium that has a reduced proportion of the fissile isotope ²³⁵U, relative to the proportion found in nature. When modeled as a neutron reflector in the TAD canister MCNP calculations, depleted uranium is treated as uranium metal at full theoretical density (18.95 g/cm³, *Nuclides and Isotopes*, Ref. 2.2.5, back cover). The isotopic distribution of the depleted uranium is conservatively based on a two-isotope natural uranium specification, i.e. [0.72 atom percent ²³⁵U, 99.28 atom percent ²³⁸U], to conservatively account for variations in source material depletion. The material specification for depleted uranium used in the TAD canister criticality safety analysis is provided in Table 18.

Table 18: Uranium Shield Material Specification

Element/ Isotope	ZAID	Atom Weight Fraction
²³⁵ U	92235.50c	0.0072
²³⁸ U	92238.50c	0.9928
Density: 18.95 g/cm ³		

Source: *Nuclides and Isotopes*, Ref. 2.2.5 (pg. 70 and back-cover) and Section 3.2.3

6.2.2.3.5 Lead

Lead, when modeled as a neutron reflector, is treated at full theoretical density (11.35 g/cm³) in the TAD canister MCNP calculations. The specification for lead, based on the material data provided in *Handbook of Chemistry and Physics* (Ref. 2.2.11 (back cover)), is detailed in Table 19.

Table 19: Lead Material Specification

Element/ Isotope	ZAID	Wt%
⁸² Pb	82000.50c	100
Density: 11.35 g/cm ³		

6.2.2.3.6 High-Level Radioactive Waste (HLW) Glass

High-Level Radioactive Waste (HLW) glass, when modeled as a neutron reflector in the TAD canister MCNP calculations, is defined using the Savannah River Site (SRS) HLW glass specification. Therefore, the isotopic distribution for HLW glass in the TAD canister MCNP calculations is established, based on the SRS HLW glass nuclide composition and concentrations. The HLW glass material specification is provided in Table 20.

Table 20. Material Specifications for Savannah River Site High-Level Waste Glass

Element/Isotope	ZAID	Wt%	Element/Isotope	ZAID	Wt%
Li-6	3006.50c	0.0960	P	15031.50c	0.0141
Li-7	3007.55c	1.3804	Cr-50	24050.60c	0.0035
B-10	5010.50c	0.5918	Cr-52	24052.60c	0.0691
B-11	5011.56c	2.6189	Cr-53	24053.60c	0.0080
O	8016.50c	44.7700	Cr-54	24054.60c	0.0020
F	9019.50c	0.0319	Cu	29000.50c	0.1526
Na	11023.50c	8.6284	Ag	47000.55c	0.0503
Mg	12000.50c	0.8248	Ba-137 ^a	56138.50c	0.1127
Al ^b	13027.50c	2.3318	Pb	82000.50c	0.0610
Si	14000.50c	21.8880	Cl	17000.50c	0.1159
S	16000.60c	0.1295	Th-232	90232.50c	0.1856
K	19000.50c	2.9887	Cs-133	55133.50c	0.0409
Ca	20000.50c	0.6619	Cs-135	55135.50c	0.0052
Ti	22000.50c	0.5968	U-234	92234.50c	0.0003
Mn	25055.50c	1.5577	U-235	92235.50c	0.0044
Fe-54	26054.60c	0.4176	U-236	92236.50c	0.0010
Fe-56	26056.60c	6.7919	U-238	92238.50c	1.8666
Fe-57	26057.60c	0.1597	Zn	N/A ^b	0.0646
Fe-58	26058.60c	0.0215	Pu-238	94238.50c	0.0052
Ni-58	28058.60c	0.4939	Pu-239	94239.55c	0.0124
Ni-60	28060.60c	0.1968	Pu-240	94240.50c	0.0023
Ni-61	28061.60c	0.0087	Pu-241	94241.50c	0.0010
Ni-62	28062.60c	0.0281	Pu-242	94242.50c	0.0002
Ni-64	28064.60c	0.0074	Density = 2.85 g/cm ³ at 25 °C, 2.69 g/cm ³ at 825 °C		

NOTES: ^a Ba-137 cross-section data unavailable; therefore substituted as Ba-138 (See Assumption 3.2.4).

^b Zn cross-section data unavailable; therefore substituted as Al-27 (See Assumption 3.2.6).

Source: DOE SRS HLW Glass Chemical Composition (Ref. 2.2.13, p. 7); Preliminary Waste Form Characteristics Report (Ref. 2.2.14, p. 2.2.1.1-4)

6.2.2.3.7 Tuff

Tuff, when modeled as a neutron reflector, is modeled 100% saturated and treated at full density (2.359 g/cm³) in the TAD canister MCNP calculations. The specification for Tuff is detailed in Table 21.

Table 21. Tuff Material Specification

Element/Isotope	ZAID	100% Saturated Atom Density (a/b-cm)
Si	14000.50c	1.7281E-02
Al-27	13027.50c	3.3505E-03
Fe-54	26054.60c	1.1224E-05
Fe-56	26056.60c	1.7604E-04
Fe-57	26057.60c	4.0676E-06
Fe-58	26058.60c	5.3724E-07
Mg	12000.50c	4.3900E-05
Ca	20000.50c	1.2135E-04
Na-23	11023.50c	1.5460E-03
K	19000.50c	1.3958E-03
Ti	22000.50c	1.8746E-05
P-31	15031.50c	9.5885E-06
Mn-55	25055.50c	1.3431E-05
O-16	8016.50c	4.5507E-02
H-1	1001.50c	7.8665E-03
Density = 2.359 g/cm ³		

NOTE: ^a Derivations are provided in Attachment IV, Homog_Mats.xls, sheet Tuff, of *Dimension and Material Specification for Use in Criticality Analyses* (Ref. 2.2.1).

^b The listed materials account for 99.16 wt% of the tuff material composition. Trace impurities (e.g., Cl, F, S, etc.) that are in quantities of 0.05 wt% and less are omitted from the representative composition since they are too sparse in concentration to have any appreciable difference on the reflective properties of the tuff

Source: *Geochemistry of Repository Block* (Ref. 2.2.15), mean values (called out by *IED Geotechnical and Thermal Parameters* (Ref. 2.2.20))

6.2.2.3.8 Titanium

Titanium, when modeled as a neutron reflector, is treated at full theoretical density (4.54 g/cm³) in the TAD canister MCNP calculations. The specification for Titanium, based on the material data provided in *CRC Handbook of Chemistry and Physics* (Ref. 2.2.11), is detailed in Table 22.

Table 22. Titanium Material Specification

Element/ Isotope	ZAID	Wt%
²² Ti	22000.60c	100
Density: 4.54 g/cm ³		

6.2.2.3.9 Alloy 22

Alloy 22, when modeled as a neutron reflector, is treated at full density (8.69 g/cm^3) in the TAD canister MCNP calculations. The specification for Alloy 22 is based on the specification provided in *Dimension and Material Specification for Use in Criticality Analyses* (Ref. 2.2.1), where it is designated as *SB-575 N06022*. The specification for Alloy 22 used in the TAD canister criticality safety analysis is detailed in Table 23.

Table 23. Material Specification for Alloy 22 (SB-575 N06022)

Element/Isotope	ZAID	Wt%	Element/Isotope	ZAID	Wt%
C-nat	6000.50c	0.0150	⁵⁸ Fe	26058.60c	0.0116
Si-nat	14000.50c	0.0800	⁵⁸ Co	27059.50c	2.5000
³¹ P	15031.50c	0.0200	⁵⁸ Ni	28058.60c	36.8024
S-nat	16032.50c	0.0200	⁶⁰ Ni	28060.60c	14.6621
V-nat	23000.50c	0.3500	⁶¹ Ni	28061.60c	0.6481
⁵⁰ Cr	24050.60c	0.8879	⁶² Ni	28062.60c	2.0975
⁵² Cr	24052.60c	17.7863	⁶⁴ Ni	28064.60c	0.5547
⁵³ Cr	24053.60c	2.0554	Mo-nat	42000.50c	13.5000
⁵⁴ Cr	24054.60c	0.5202	¹⁸² W	74182.55c	0.7877
⁵⁵ Mn	25055.50c	0.5000	¹⁸³ W	74183.55c	0.4278
⁵⁴ Fe	26054.60c	0.2260	¹⁸⁴ W	74184.55c	0.9209
⁵⁶ Fe	26056.60c	3.6759	¹⁸⁶ W	74186.55c	0.8636
⁵⁷ Fe	26057.60c	0.0865	Density = 8.69 g/cm^3		

Source: *Dimension and Material Specification for Use in Criticality Analyses* (Reference 2.2.1)

6.3 CALCULATION METHODOLOGY

This section presents the methodology used to evaluate the criticality safety performance of the TAD canister-based systems under both normal and potential off-normal conditions. The calculation methodology is structured according to the operating circumstances considered; namely 'normal conditions' and 'off-normal' conditions.

6.3.1 Evaluation of Normal Conditions

All TAD canisters received and accepted into the surface and sub-surface facilities will be hermetically sealed, with a dry, intact, basket containing intact commercial spent nuclear fuel with a maximum initial enrichment of 5 wt % ²³⁵U/U. Under normal conditions, operations associated with receipt and handling of the TAD canisters in the surface facilities, in addition to operations concerned with emplacement of the TAD canisters within the sub-surface facility, will not alter these conditions.

6.3.1.1 Anticipated Surface Facility and Intra-Site Operations

Operations conducted in the surface facilities¹ (which include Intra-Site operations) concern the preparation of the received TAD canisters for disposal in the Subsurface facility. These preparatory operations primarily entail:

- Receipt of transportation casks containing commercial SNF in TAD canisters (CRCF & RF);
- Unpending and removal of transportation casks from their conveyance, including unbolting and removal of lids from casks (CRCF & RF);
- Transfer of the TAD canisters from their transportation cask to an aging overpack (CRCF);
- Transfer of TAD canisters in aging overpacks between the RF, WHF, CRCF, and Aging Facility (Intra-Site);
- Aging of TAD canisters in aging overpacks on an aging pad (Aging Facility);
- Receipt of loaded TAD canisters inside aging overpacks from the aging pad (CRCF);
- Transfer of canisters from transportation casks and aging overpacks into waste packages (CRCF);
- Installation and welding of the waste package inner and outer lids (CRCF); and
- Transfer of the completed waste package, using the TEV to the Subsurface facility for emplacement into the disposal drifts (Intra-Site).

Based on the abovementioned surface facility operations, it is evident that all TAD canisters will be handled individually in the surface facilities. However, it is recognized that TAD canisters could be placed within close proximity to other TAD canisters prior to loading into waste packages and emplacement in the Subsurface facility, or loading into overpacks for aging.

To demonstrate the subcriticality of the TAD canisters under the abovementioned normal conditions within the surface facilities, the PWR and BWR TAD canisters containing representative fuel assemblies (Section 6.2.1.2) are evaluated individually (i.e. as a single isolated canister) and in an infinite planar array configuration.

The single canister models are based on the models described in Section 6.2.1.1 but with incorporated close fitting full-thickness (i.e. 30 cm) reflection adjacent all surfaces of the canister. A series of reflector materials (Section 6.2.2.3) are examined for the single PWR TAD canister case to determine the limiting reflector condition. The limiting reflector material established from the single PWR TAD canister calculations is applied to the single BWR TAD canister calculation. Based on neutron mean free paths in the various reflecting materials, the

¹ Note that the WHF pool and IHF are excluded from the scope of surface facilities in this criticality safety analysis.

reflection conditions accounted for in this criticality safety calculation are considered to bound the reflections conditions that could be realized in the surface and subsurface facilities. Refer to Figure 12 through Figure 14 for a cross-section view of the PWR and BWR single canister models with incorporated close-fitting full reflectors. It should be noted that, under normal conditions, the TAD canister contents are assumed to be essentially undamaged, however, movement of the fuel assemblies within the fuel assembly compartments could potentially occur during handling. To account for potential displacement of fuel assemblies within their compartments, the normal conditions single (i.e. isolated) PWR and BWR TAD canister models are also evaluated with a hypothetical, idealized, fuel assembly configuration in which the fuel assemblies are 'bunched' by preferential displacement within their compartments. The bunched fuel assembly configurations are illustrated in Figure 17 and Figure 18 for the isolated PWR and BWR TAD canisters, respectively.

The canister infinite planar array configuration models are based on the non-bunched models described in Section 6.2.1.1 but include close fitting full-thickness (30 cm) reflection adjacent the upper and lower surfaces of the canister, equivalent to the axial reflection conditions considered for the single (i.e. isolated) canister calculation models. The non-bunched fuel assembly models are employed for the canister infinite planar array calculations because, based on the single canister analysis, fuel assembly bunching is inconsequential to criticality safety of the canister system (Table 24). A periodic boundary hexagonal lattice is applied directly adjacent the cylindrical surface of the canister to simulate an infinite planar array of canisters in a close packed, triangular-pitched, configuration. The space between the periodic boundary and the TAD shell represents the interstitial space between the canisters in the array. This interstitial space is evaluated as void and is separately evaluated with variable density water. Refer to Figure 14 through Figure 16 for a cross-section view of the PWR and BWR infinite planar array canister model with incorporated close-fitting full-thickness axial reflectors.

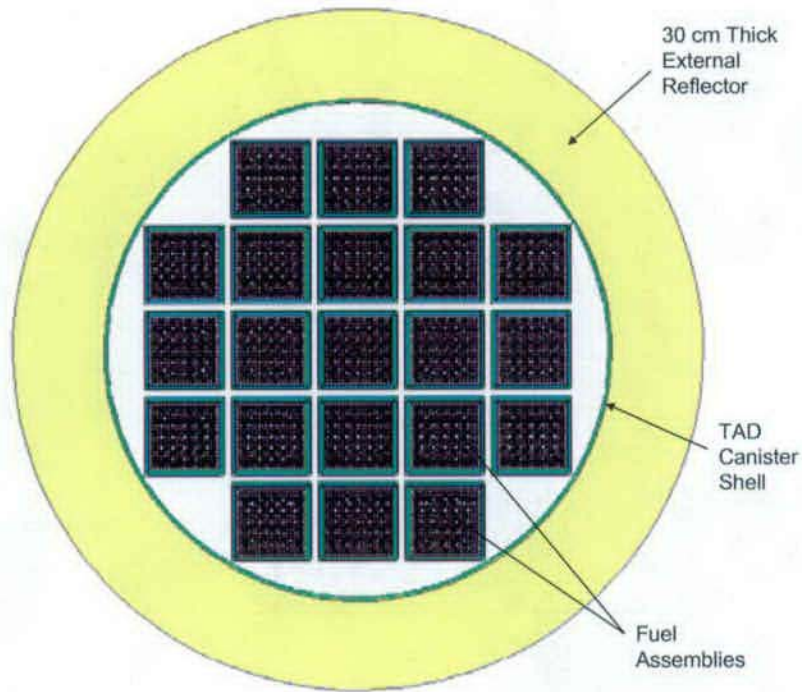

Source: Original
Figure 12. Radial Cross-Section of the PWR TAD Canister MCNP Model with Radial Reflector (Fuel Assemblies Illustrated)

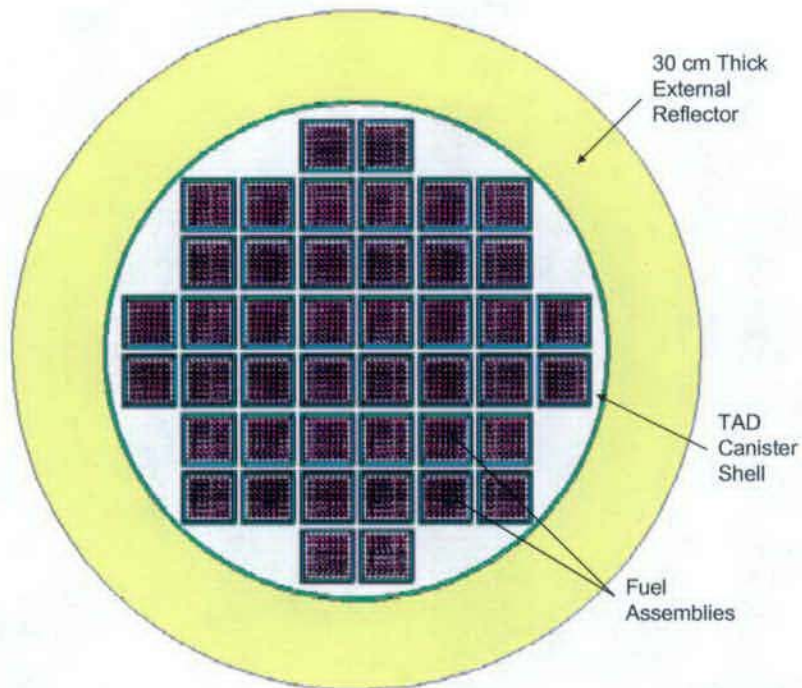

Source: Original
Figure 13. Radial Cross-Section of the BWR TAD Canister MCNP Model with Radial Reflector (Fuel Assemblies Illustrated)

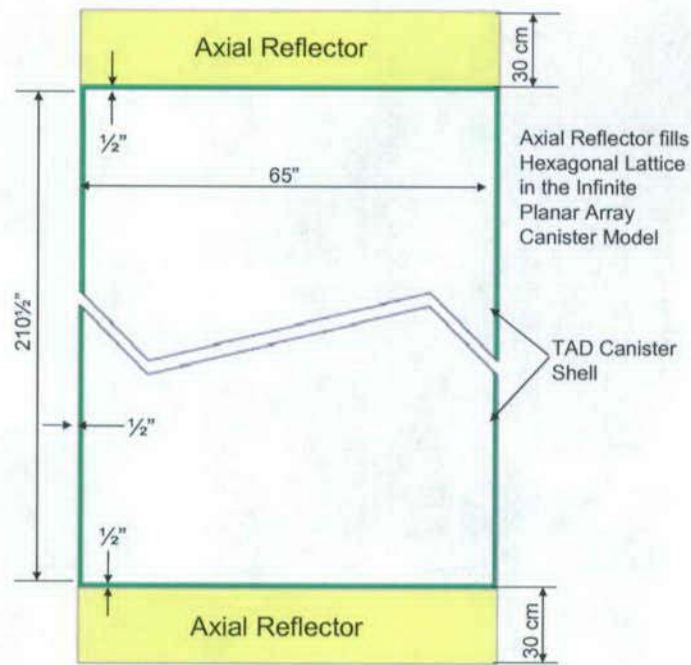

Source: Original
 Figure 14. Axial Cross-Section of the Single TAD Canister Models and Infinite Planar Array TAD Canister MCNP Models (Fuel Assemblies Not Illustrated)

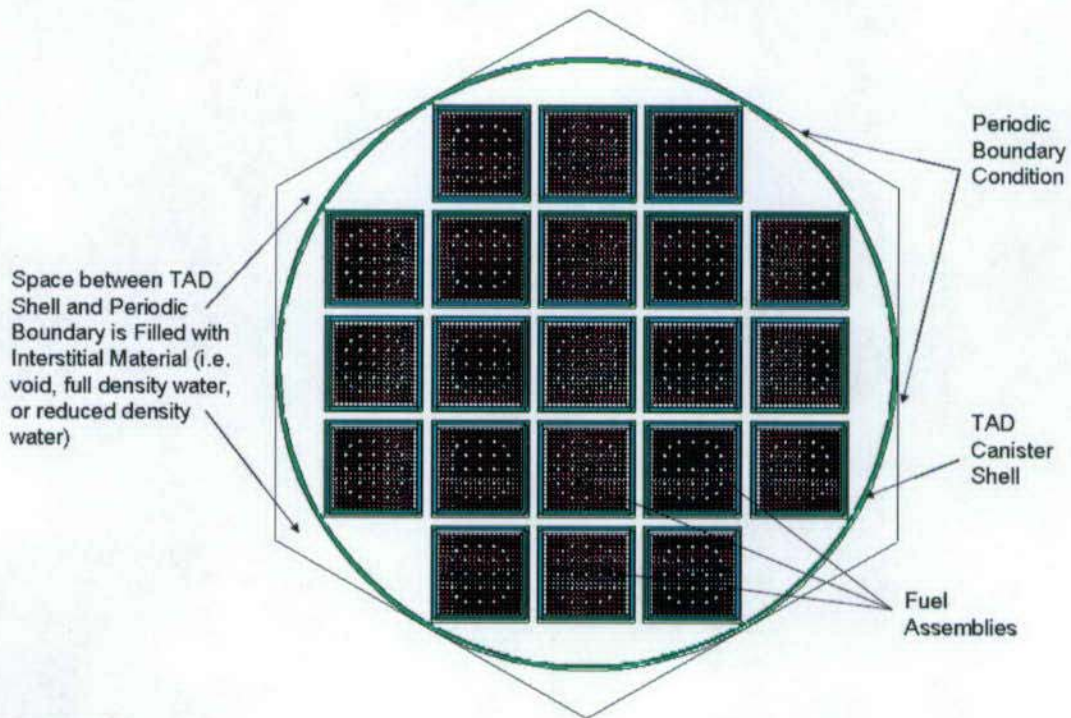

Source: Original
 Figure 15. Radial Cross-Section Illustration of the PWR TAD Canister MCNP Model with Periodic Boundary Condition (to Simulate an Infinite Planar Array of TAD Canisters)

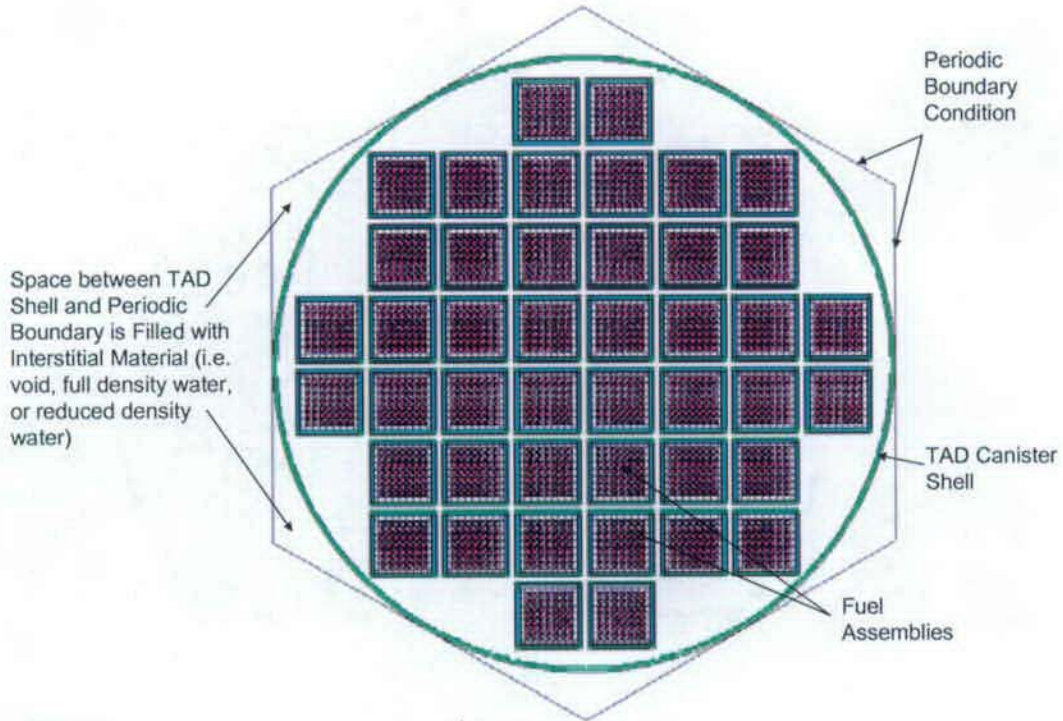

Source: Original

Figure 16. Radial Cross-Section Illustration of the BWR TAD Canister MCNP Model with Periodic Boundary Condition (to Simulate an Infinite Planar Array of TAD Canisters)

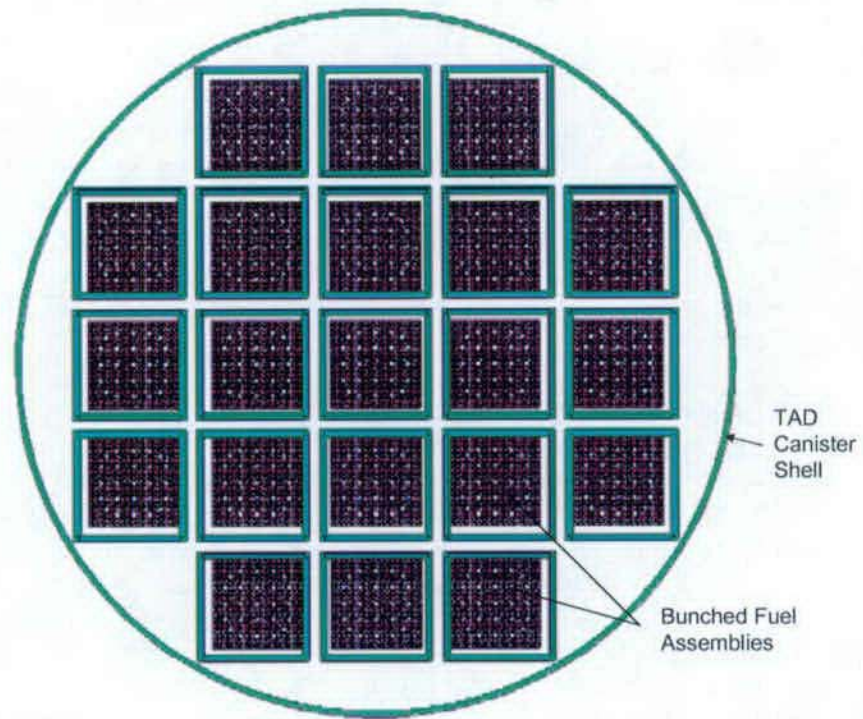

Source: Original

Figure 17. Radial Cross-Section of the PWR TAD Canister MCNP Model Illustrating Maximum Fuel Assembly Bunching (Radial Reflector Not Illustrated)

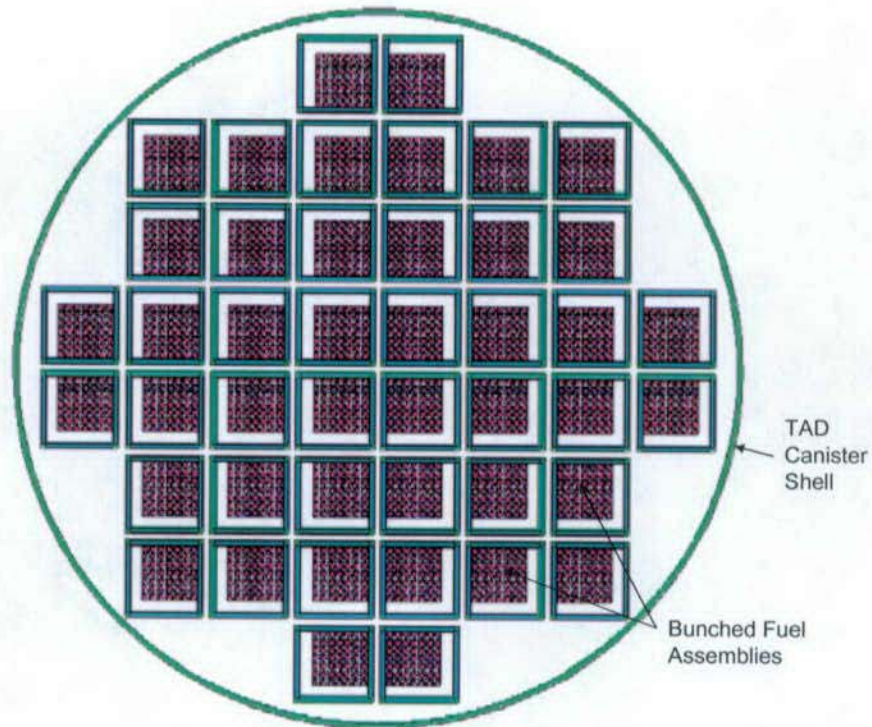

Source: Original

Figure 18. Radial Cross-Section of the BWR TAD Canister MCNP Model Illustrating Maximum Fuel Assembly Bunching (Radial Reflector Not Illustrated)

6.3.1.2 Anticipated Subsurface Facility Operations

Operations conducted in the Subsurface facility concern the receipt and placement of loaded, sealed, waste packages containing CSNF, DOE SNF, naval SNF and HLW glass. The analysis of sealed waste packages positioned in the Subsurface facility emplacement drifts is performed in this document for waste packages containing TAD canister-based systems. Analysis of sealed waste packages containing DOE SNF canisters is contained in a separate analysis. Analysis of sealed waste packages containing naval SNF is provided in the Naval Nuclear Propulsion Program Technical Support Document.

Within the Subsurface facility, TAD canisters (sealed in their waste package) are arranged in a continuous row within the emplacement drifts. Due to their emplacement configuration (which only provides for close proximity between adjacent canisters, axially), it is expected that there is little neutron interaction between each TAD canister, and thus, it is expected that the reactivity of a single fully reflected TAD canister will be very similar to the reactivity of a fully reflected continuous row of TAD canisters positioned in an emplacement drift.

To demonstrate the subcriticality of the TAD canisters under the abovementioned normal conditions within the sub-surface facility, the PWR TAD canisters containing representative fuel assemblies (Section 6.2.1.2) are evaluated in an emplacement configuration. The single canister models described in Section 6.2.1.1 are employed for this analysis, but with modification to apply a mirror boundary condition to the axial ends of the canister, and to incorporate a close

fitting full-thickness (30 cm) reflector adjacent the cylindrical surface of the canister. Similar to the surface facility calculations, a series of reflector materials (Section 6.2.2.3) are examined to determine the limiting reflection condition associated with emplaced TAD canisters. The limiting reflector material established from the PWR TAD canister emplacement configuration calculation is applied to the BWR TAD canister emplacement configuration calculation. Owing to the range of full (i.e. 30 cm thick) close fitting reflectors considered, and the mirror boundary condition used at the axial ends of the canister, the TAD canister emplacement models are considered to bound the actual conditions that could be realized in the Subsurface facility. Refer to Figure 19 for a cross-section view of the PWR and BWR TAD canister models with the incorporated close-fitting full-thickness radial reflector and axial mirror boundary condition.

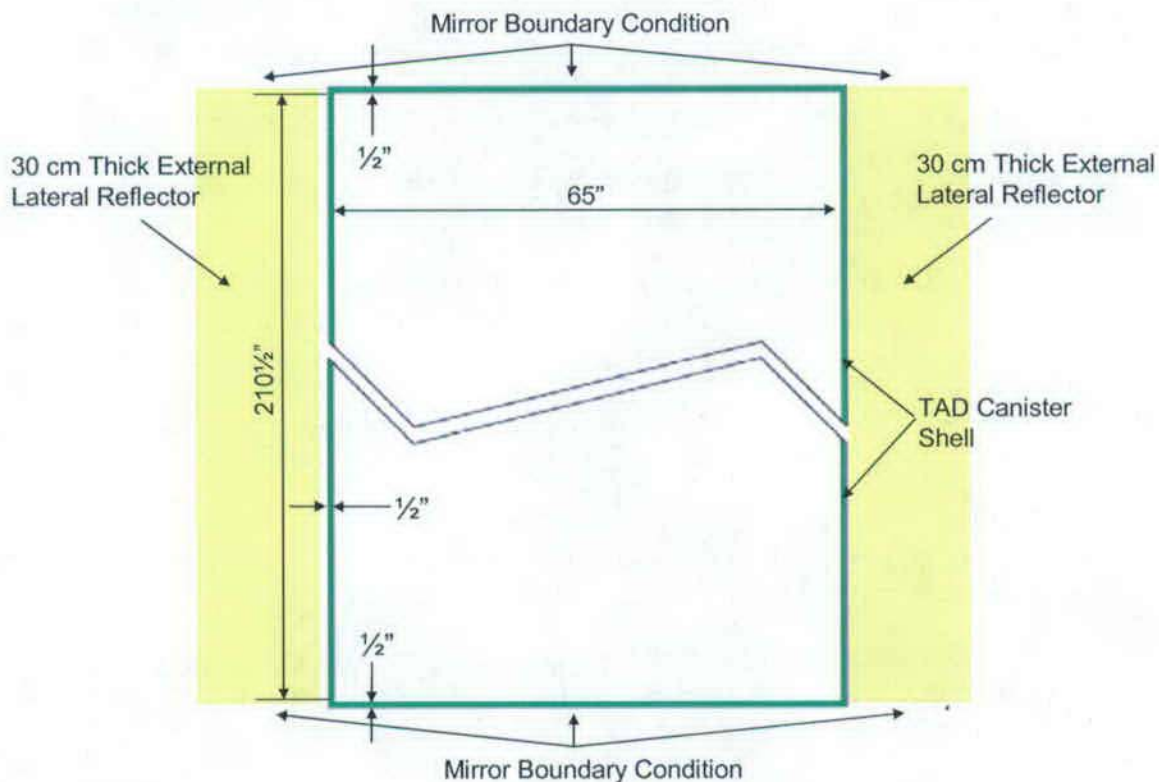

Source: Original

Figure 19. Axial Cross-Section of the Emplacement Configuration TAD Canister MCNP Models (Fuel Assemblies Not Illustrated)

6.3.2 Evaluation of Off-Normal Conditions

All TAD canisters received and accepted into the surface and Subsurface facilities will be hermetically sealed, with a dry, intact, basket containing intact commercial spent nuclear fuel with a maximum initial enrichment of 5 wt % $^{235}\text{U}/\text{U}$. The realization of off-normal conditions within the surface facilities could potentially result in a compromise to the integrity, desiccation and geometry of the TAD canisters, their basket structure and their CSNF payload. Furthermore, manufacturing errors could potentially result in received TAD canisters containing improper

quantities of borated stainless steel, or reduced boron content in the borated stainless steel panels associated with the TAD canister basket.

6.3.2.1 Surface Facilities and Intra-Site Operations

The scope of normal operations pertinent to the surface facilities is summarized in Section 6.3.1. Any deviation from the scope of normal operations (e.g. dropping of a TAD canister during transfer into a shielding cask or waste package) could potentially erode the significant criticality safety margin established for normal operations (Section 7.1).

Under off-normal conditions it is postulated that the integrity, desiccation and geometry of the TAD canisters located in their sealed waste packages is compromised. To characterize the system behavior and response to changes in properties (such as geometry, moderation and neutron absorber content), a comprehensive analysis of the TAD canisters is performed. This sub-section defines the systematic method employed for this off-normal condition analysis.

The key aspects of the off-normal conditions analysis involve postulated damage to the TAD canister resulting in:

1. Deformation of the TAD canister shell, coincident with a release of liquid moderator within the vicinity of the canister, leading to a progressive entrainment of moderator into the canister cavity (depicted in Figure 21);
2. Deformation of the TAD canister basket structure, leading to a progressive closure of the fuel compartment flux trap gap (depicted in Figure 22 and Figure 23);
3. Deformation of the fuel assemblies positioned in the TAD canister fuel compartments, resulting in a progressive expansion of the fuel pin pitch, often termed 'birdcaging' (depicted in Figure 22 and Figure 23); and
4. Deformation of the fuel assemblies positioned in the TAD canister fuel compartments, to the extent that there is a progressive release of fuel into the canister cavity (depicted in Figure 24).

In addition to the postulated TAD canister damage scenarios, the off-normal conditions analysis considers:

5. Manufacturing errors resulting in a reduction in the boron content of the borated stainless steel panels associated with the canister basket structure.

The four abovementioned facility-based off-normal scenarios (items 1 through 4) are very conservative approximations of the damage that could potentially be realized in the event of accidental release of the TAD canister-based systems during handling.

Because the TAD canister systems are maneuvered vertically, it is considered unlikely that a horizontal or near horizontal drop could occur. A horizontal drop could cause the fuel assembly compartments to congregate, i.e. could cause a reduction in the compartment flux trap gap. However, the horizontal impact that would be necessary to promote such conditions would also

be expected to cause the pins within each fuel assembly to bunch together. Since LWR fuel assemblies are typically under moderated, a reduction in pin pitch would be expected to reduce k_{eff} . Refer to Figure 20 for an illustration of the type of damage that would be considered representative¹ of a horizontal impact event.

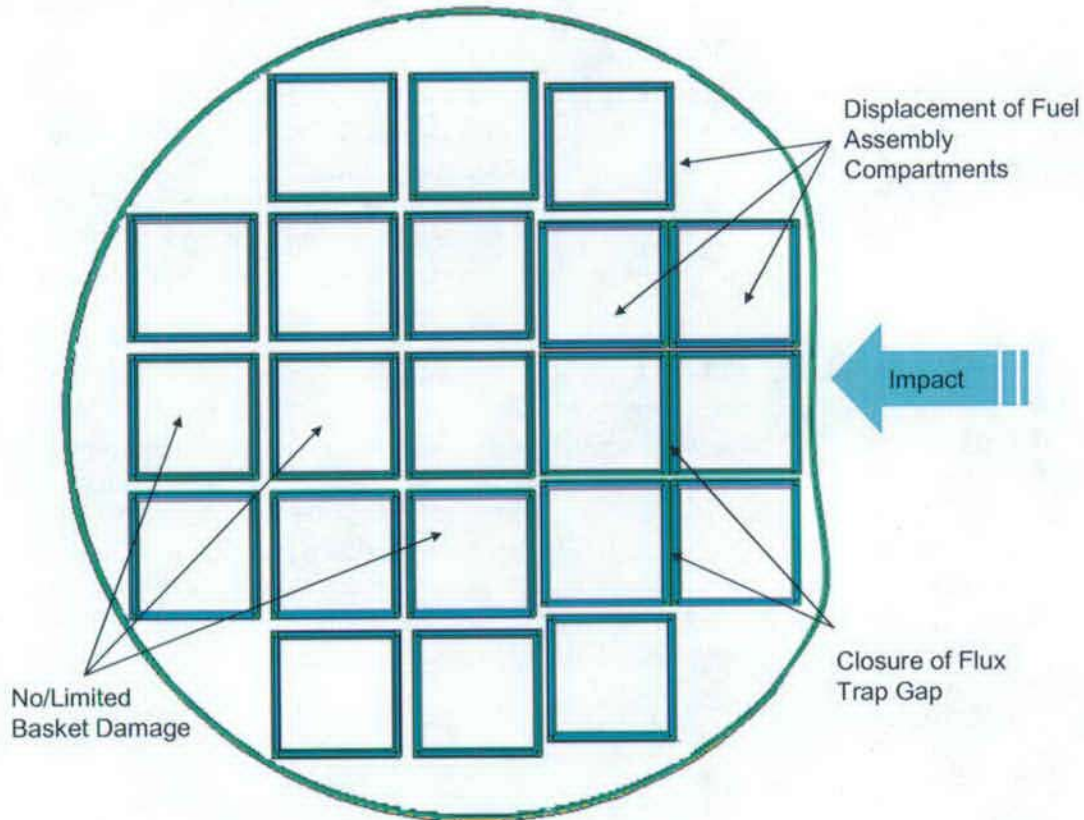

Source: Original

Figure 20. Radial Cross-Section Sketch of a Damaged PWR TAD Canister Depicting Basket Damage Considered Representative of a Horizontal Impact Event

An increase in pin pitch, up to and including a condition where the fuel pins just fit within the fuel compartments, is often referred to as 'birdcaging', and is considered to arise from an axial impact. For the TAD canister-based systems, an axial, i.e. end-on impact, could occur in the event of a vertically orientated drop/impact during handling. A further consequence of an axial impact is the potential for the release of fuel into the canister cavity, resultant from rupture of fuel pins. A very conservative treatment of this condition is to assume that the fuel debris collects in a localized region of the canister cavity where liquid moderator has coincidentally entrained, and subsequently mixes forming a homogeneous fuel and moderator mixture, with an optimum fuel concentration. A homogeneous representation of the assumed fuel-water sludge is appropriate because any significant impact event that would cause a significant release of fuel (via physical rupture of fuel pins) would be expected to result in disintegration of the fuel pellets

¹ Note that Figure 20 portrays the characteristic pattern of basket damage resultant from a horizontal drop, and does not reflect the actual off-normal configurations analyzed in the criticality safety calculations. Refer to the Figures provided in Section 6.3.2.1.1 for illustration of the actual MCNP models.

released. Furthermore, considering the very limited space available within the TAD canister cavity, the realization of an optimum concentration condition would naturally require the fuel debris to consist of fine particles. Whole pellets or large pellet fragments would simply lack the mobility necessary to form the optimum concentration conditions considered in the calculations, due to the physical impediment afforded by the intact fuel and basket structure within the canister cavity.

On the basis that the TAD canister systems are maneuvered vertically during handling, it is unlikely that a horizontal impact could occur, and thus it is unlikely that collapse of the flux trap gap between fuel assembly compartments could occur. Flux trap gap collapse in conjunction with fuel assembly birdcaging would require concurrent significant horizontal and vertical impacts. Clearly, consideration of fuel assembly birdcaging in conjunction with collapse of the flux trap gap between fuel assembly compartments represents a very conservative model of off-normal conditions.

To characterize the behavior of the TAD canister-based systems under the five potential off-normal conditions outlined above, a comprehensive parametric study is performed for both the PWR and BWR TAD canisters, with each canister variant containing a representative fuel assembly (Section 6.2.1.2). The parametric study is split into two components; a detailed parametric study and an ancillary study. The detailed parametric study is based on a single (i.e. isolated) TAD canister, and considers moderator intrusion, basket deformation, fuel deformation, fuel release and neutron absorber reduction. The ancillary analysis supplements the detailed parametric study and includes evaluation of the effect of intrusion of an alternate moderator (hydraulic fluid), in addition to the effect of grouping multiple damaged TAD canisters within an array.

6.3.2.1.1 Detailed Parametric Study

Similar to the evaluation of normal conditions, the single canister off-normal conditions model (upon which the detailed parametric study is based) incorporates close fitting full-thickness (30 cm) reflection adjacent all surfaces of the canister. A series of reflector materials (Section 6.2.2.3) are examined to determine the limiting reflection condition. Unlike the normal conditions analysis, the limiting reflector material is established, independently, for both the PWR TAD canister and the BWR TAD canister calculation. Examination of alternate reflectors is performed for the off-normal conditions analysis (rather than using the worst-case reflector established from the normal conditions analysis) in recognition of softening of the neutron spectrum from moderation of the canister contents.

The detailed TAD canister off-normal conditions calculations are structured into three scenarios, as follows:

Potential Off-Normal Scenario 1

- Progressive canister basket deformation (i.e. flux trap gap collapse),
- Progressive fuel assembly deformation (i.e. birdcaging), and
- Progressive flooding of the TAD canister with water.

Potential Off-Normal Scenario 2

- Progressive canister basket deformation (i.e. flux trap gap collapse),
- Maximum fuel assembly deformation (i.e. birdcaging),
- Progressive reduction of the neutron absorber content of the canister basket, and
- Progressive flooding of the TAD canister with water.

Potential Off-Normal Scenario 3

- Progressive canister basket deformation (i.e. flux trap gap collapse),
- Progressive fuel assembly deformation (i.e. birdcaging),
- Progressive fuel release (i.e. fuel break-up), and
- Progressive flooding of the TAD canister with water.

6.3.2.1.1.1 Potential Off-Normal Scenario 1

Potential off-normal scenario 1 is based on progressive degrees of canister basket deformation (i.e. flux trap gap collapse), fuel assembly deformation (i.e. birdcaging), and progressive flooding of the TAD canister (from the base upwards) with water moderator. It is noted that only vertically orientated TAD canister arrangements (as opposed to horizontal arrangements) are considered for all moderator intrusion cases to minimize the volume of water required to exceed the USL.

The height of the modeled water moderator region at the base of the canister cavity is dependent on the total moderator volume considered and the available volume per unit height within the canister cavity. The height of the water moderator region is calculated according to the following method:

1. The available volume per unit height within the canister is established by calculating the cross-sectional area of the canister cavity and subtracting the volume per unit height of structure contained within the canister cavity (i.e. fuel, and basket material).
2. The height of the moderator region is determined by dividing the moderator volume by the "available volume per unit height" derived in step 1.

The specific moderator height values used in the MCNP calculations are listed in the Microsoft Excel spreadsheet *tad_canister_calculations.xls*, included in the DVD file of Attachment V. A graphic illustration of the MCNP model showing a water moderated region is provided in Figure 21.

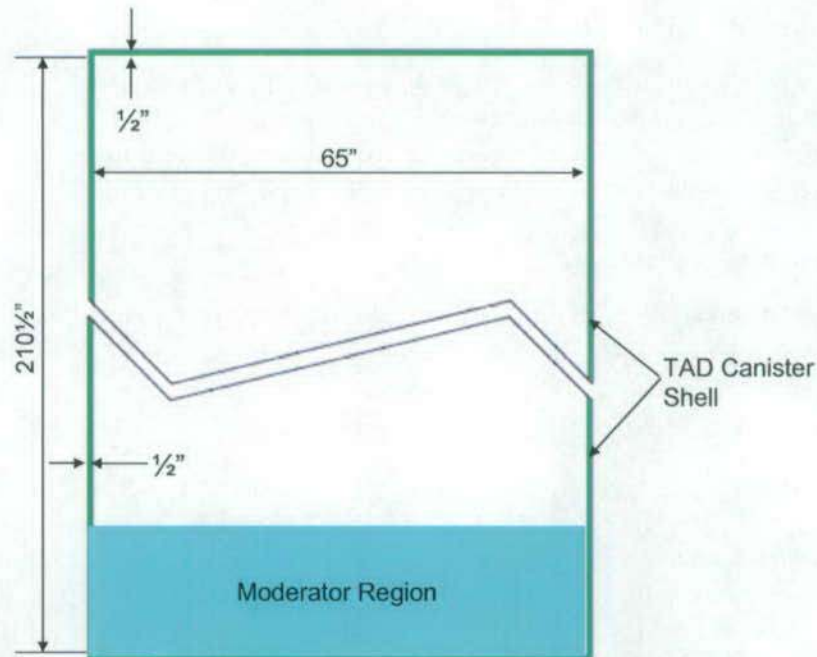

Source: Original

Figure 21. Axial Cross-Section of the TAD Canister MCNP Model Depicting Moderator Intrusion (Fuel Assemblies Not Illustrated)

6.3.2.1.1.2 Potential Off-Normal Scenario 2

Potential off-normal scenario 2 is based on progressive degrees of canister basket deformation (i.e. flux trap gap collapse), maximum fuel assembly deformation (i.e. birdcaging), reduction of the neutron absorber content of the basket borated stainless steel panels, and progressive flooding of the TAD canister (from the base upwards) with water. The height of the modeled water moderator region at the base of the canister cavity is calculated according to the method described for potential off-normal scenario 1 above.

No variation of fuel assembly deformation (i.e. birdcaging) is considered for off-normal scenario 2 because the effect of this type of damage is relatively insensitive to changes in the neutron absorber content of the borated stainless steel panels (Section 7.1.2.1.1.3, paragraph 4). Conversely, closure of the flux trap gap directly influences the neutron absorbed worth of the borated stainless steel panels, since this type of damage directly affects the thermalization of neutrons traversing the inter-compartment gaps.

6.3.2.1.1.3 Potential Off-Normal Scenario 3

Potential off-normal scenario 3 is based on progressive degrees of canister basket deformation (i.e. flux trap gap collapse), fuel assembly deformation (i.e. birdcaging), fuel release (i.e. fuel break-up resulting in formation of an optimum fuel-water sludge at the base of the canister cavity), and progressive flooding of the TAD canister (from the base upwards) with water. Refer to Figure 22 through Figure 24 for a graphic illustration of these particular damage conditions.

The evaluation of potential off-normal scenario 3 is restricted to the PWR TAD canister only, because the results of off-normal scenarios 1 and 2 (Section 7.1.2) conclusively prove that the PWR TAD canister is more restrictive than the BWR TAD canister in terms of the maximum tolerable damage and moderation combinations.

From the description of the potential off-normal scenario models (see for example the bulleted list at the beginning of Section 6.3.2.1.1), it is seen that the off-normal scenario 1 and 3 models differ only in the absence and presence of a fuel-water sludge, respectively. Therefore, in developing the potential off-normal scenario 3 models, the MCNP models employed for the potential off-normal scenario 1 calculations are modified to provide a region containing an optimum concentration fuel-water sludge. This is achieved by segregating the water moderated region at the base of the canister into a fuel-water sludge region and an excess water region (modeled directly above the fuel-water sludge region). An illustration of this configuration is provided in Figure 24.

The height of the fuel-sludge region is varied in the MCNP calculations to account for the specific fuel-release fraction considered (i.e., 1, 3, or 5 wt%), while the height of the excess water moderator region is independently varied. The total volume of water within the TAD canister is calculated by adding the volume of water in the excess water region (determined using the method established for potential off-normal scenario 1) to the volume of water present in the fuel-water sludge region. The volume of water associated with the fuel-water sludge region is determined by subtracting the volume of the fuel debris and intact components (e.g. fuel in rods, basket, etc.) displacing the fuel-water sludge from the total volume of the fuel-water sludge region. The specific fuel-water sludge height and excess water moderator height values used in the MCNP calculations are listed in the Microsoft Excel spreadsheet *tad_canister_calculations.xls*, included in the DVD file of Attachment V.

For all calculations performed for off-normal scenario 3, the fuel-water sludge at the base of the canister cavity is modeled at optimum concentration given the moderator volume constraints imposed. For example, for scenarios involving relatively large quantities of entrained moderator, the fuel-water sludge is modeled at optimum concentration, and the excess moderator is modeled directly above the fuel-water sludge region. However, for cases with a relatively small volume of entrained moderator, the fuel-water sludge is modeled at the optimum concentration corresponding to the available moderator volume within the canister. For these relatively small moderator volume cases, this is typically the minimum concentration possible. Thus, while the actual concentration modeled may deviate depending on the moderator volume considered in the calculation, the modeled concentration is always optimized (i.e. is the most reactive uniform concentration possible).

The optimum fuel-water sludge concentration used in the detailed calculations is determined in a separate precursor calculation by modeling a fully loaded TAD canister with representative commercial fuel, and adding a fixed mass of UO_2 as a fuel-water sludge. The optimum concentration of the fuel-water sludge is established by varying the concentration of UO_2 in the fuel-water sludge. It is noted that no intact fuel is removed from the model to offset the fuel release fraction considered. This approach is considered conservative on account of an overall increase in total fuel mass (resultant from the addition of fuel associated with the fuel-water sludge).

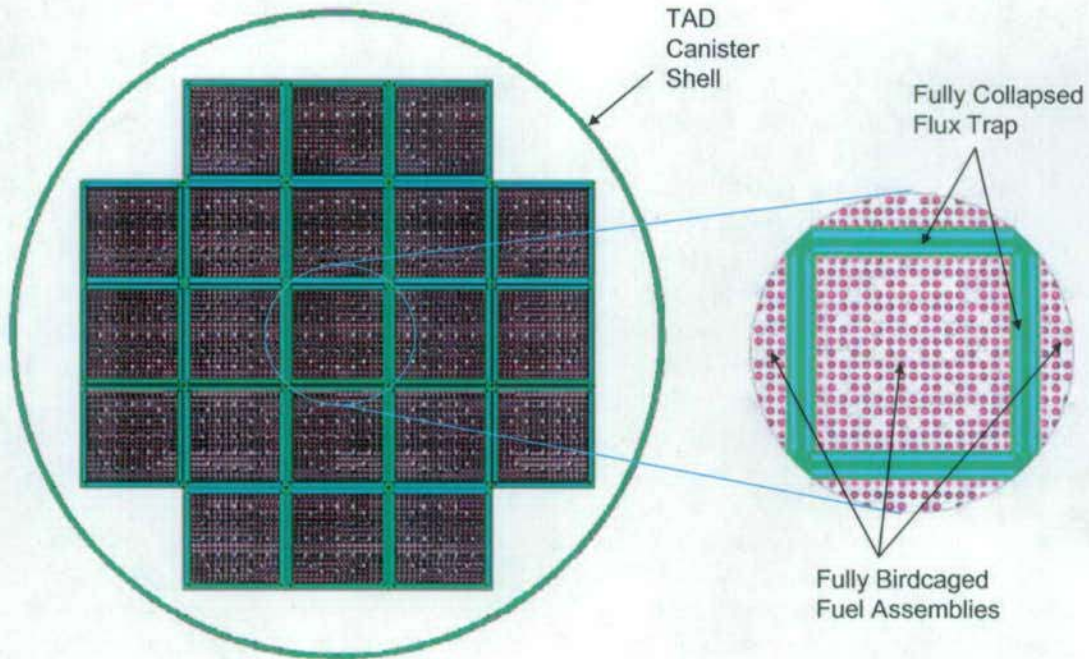

Source: Original

Figure 22. Radial Cross-Section of the PWR TAD Canister MCNP Model Depicting Maximum Flux Trap Gap Collapse and Maximum Fuel Assembly Birdcaging

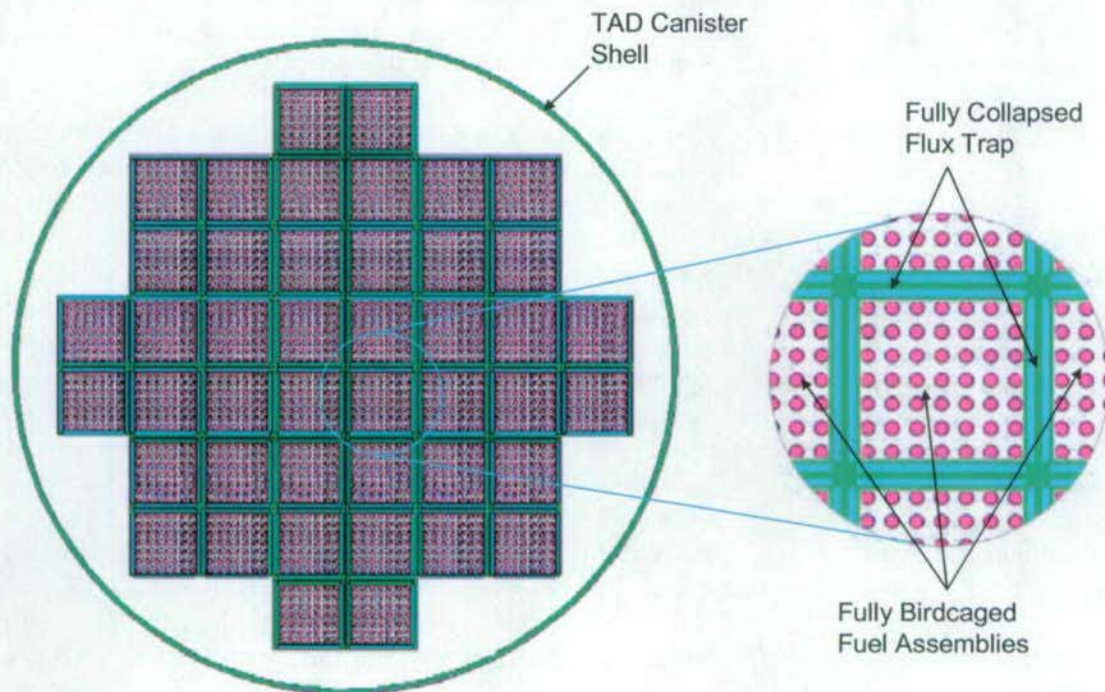

Source: Original

Figure 23. Radial Cross-Section of the BWR TAD Canister MCNP Model Depicting Maximum Flux Trap Gap Collapse and Maximum Fuel Assembly Birdcaging

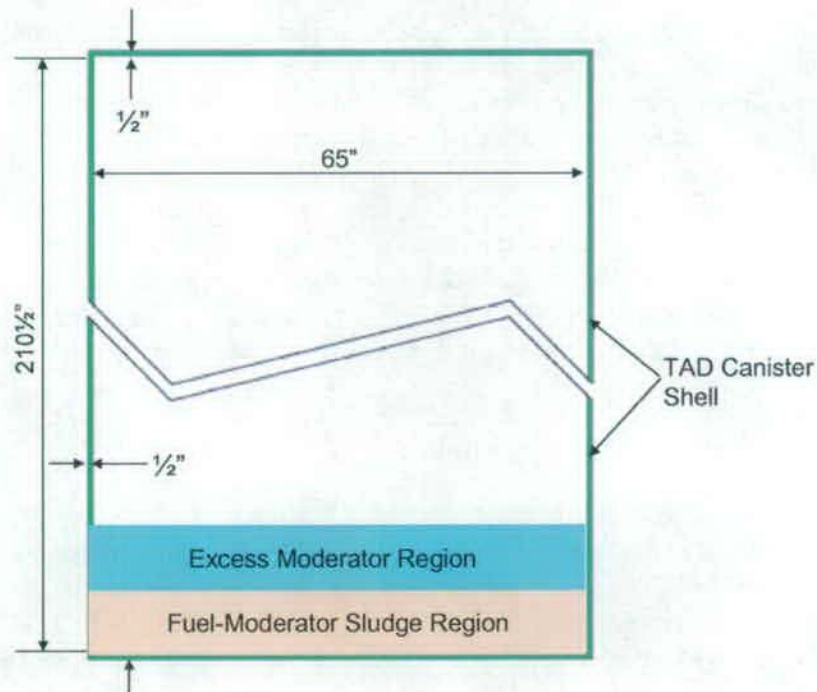

Source: Original

Figure 24. Axial Cross-Section of the TAD Canister MCNP Model Depicting Moderator Intrusion in Conjunction with Fuel Release (Fuel Assemblies Not Illustrated)

6.3.2.1.2 Ancillary Study

The ancillary potential off-normal conditions analysis supplements the detailed parametric study described in Section 6.3.2.1.1 (which is based on damage of a single canister only), and includes evaluation of the effectiveness of various reflecting media on the moderator limits established in the preceding detailed analysis. In addition, the ancillary analysis establishes the effect of grouping **multiple** damaged TAD canisters within an array, and quantifies the effect of intrusion of an alternate moderator (hydraulic fluid) into the canister cavity.

6.3.2.1.2.1 Reflecting Media

Based on the results of the normal conditions analyses (Section 7.1.1), it is expected that stainless steel represents one of the most onerous reflector materials from a criticality safety viewpoint. To confirm this expectation under potential off-normal conditions involving damage to the TAD canister in conjunction with damage and partial moderation of its contents, the worst case off-normal conditions model from potential off-normal scenario 1 (Section 6.3.2.1.1.1) is re-evaluated with alternate close-fitting 30 cm thick reflector materials. A series of reflector materials (Section 6.2.2.3) are examined for both the PWR and BWR TAD canisters.

6.3.2.1.2.2 Damaged Canister Array

The model of the infinite planar array of damaged TAD canisters is based on the maximum damaged single canister condition (i.e. maximum fuel assembly birdcaging and complete collapse of the canister compartment flux trap gap). Similar to the evaluation of an infinite

planar array of TAD canisters under normal conditions (Section 6.3.1.1), a hexagonal lattice with a periodic boundary condition is modeled directly adjacent the cylindrical surface of the canister to simulate an infinite planar array of canisters in a close package, triangular-pitched, configuration. The interstitial space between the canisters in the array (i.e. the space between the periodic boundary and the TAD shell) is modeled as void¹. A close fitting full-thickness (30 cm) reflector is included adjacent the upper and lower surfaces of the canister, with a series of reflector materials (Section 6.2.2.3) examined to determine the limiting reflection condition. Note that the examination of alternate reflectors is re-performed for the off-normal conditions analysis (rather than using the worst-case reflector established from the normal conditions analysis) in recognition of softening of the neutron spectrum from moderation of the canister contents.

6.3.2.1.2.3 Hydraulic Fluid Moderator

The detailed off-normal conditions study described in Section 6.3.2.1.1 considers only water as a potential moderator. To evaluate the effect on the established maximum safe moderator quantities in the event of entrainment of an alternate moderator (hydraulic fluid), the limiting (i.e. worst-case) intact fuel off-normal conditions model for the PWR TAD canister is re-evaluated with an equivalent volume of polysiloxane fluid, which is a representative hydraulic fluid (refer to Section 3.2.5 for details).

¹ The presence of water in the interstitial space between TAD canisters in a planar array configuration results in a reduction in k_{eff} (Figure 27).

7. RESULTS AND CONCLUSIONS

This section presents the results of, and draws conclusions from, the MCNP criticality safety calculations performed in support of the criticality safety demonstration of the TAD canister-based systems, under both normal conditions and potential off-normal conditions. The following structure is used:

- Section 7.1 presents the results of the MCNP calculations performed in support of demonstrating the criticality safety of the PWR and BWR TAD canister systems in the surface and sub-surface facilities, under both normal conditions and potential off-normal conditions; and
- Section 7.2 draws conclusions from the results of the normal condition and potential off-normal condition calculations, and identifies the limits on system parameters that are necessary to ensure the subcriticality of the TAD canister-based systems under all foreseeable conditions in the surface and Subsurface facilities.

7.1 RESULTS

7.1.1 Normal Conditions

All TAD canisters received and accepted into the surface and Subsurface facilities will be hermetically sealed, with a dry, intact, basket containing intact commercial spent nuclear fuel with a maximum initial enrichment of 5 wt % $^{235}\text{U}/\text{U}$. Under normal conditions, operations associated with receipt and handling of the TAD canisters in the surface facilities, in addition to operations concerned with emplacement of the TAD canisters within the Subsurface facility, will not alter these conditions.

7.1.1.1 Surface Facilities and Intra-Site Operations

The criticality safety process for evaluating the TAD canister-based systems under normal conditions in the surface facilities (including Intra-Site operations) is described in detail in Section 6.3.1.1.

The results of the single PWR TAD canister calculations performed based on the process defined in Section 6.3.1.1 are presented in Figure 25.

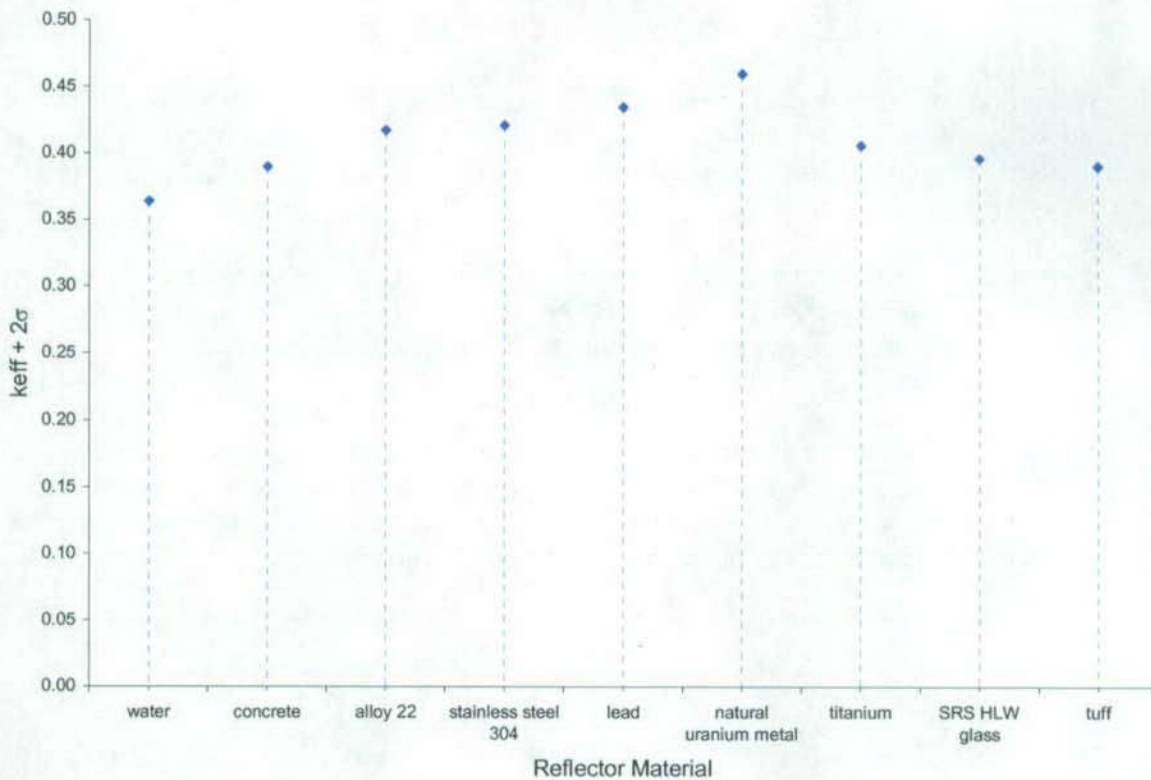

Source: Original

Figure 25. Variation of $k_{eff} + 2\sigma$ with Close Fitting Full-Thickness (I.E. 30 Cm) Reflector Material, for a Single Undamaged Dry PWR TAD Canister Containing Intact, Undamaged, Representative CSNF

The results of the single PWR and BWR TAD canister calculations, with the limiting reflector material established in Figure 25, are detailed in Table 24. The results of the fuel assembly bunching calculations (which utilized the same limiting reflector material) are also presented.

Table 24. Comparison of $k_{eff} + 2\sigma$ Values for Single Undamaged Dry PWR and BWR TAD Canisters Containing Intact, Undamaged, Representative CSNF, and with Close Fitting Full-Thickness (I.E. 30 Cm) Natural Uranium Metal Reflection

TAD Canister Variant	Close Fitting 30 cm Thick Reflector Material	Fuel Assembly Configuration in the TAD Canister Compartments	$k_{eff} + 2\sigma$
PWR	Natural uranium metal	Centered	0.45829
PWR	Natural uranium metal	Bunched	0.46165
BWR	Natural uranium metal	Centered	0.45107
BWR	Natural uranium metal	Bunched	0.45001

Based on the results presented in Table 24, it is seen that under normal (i.e. dry, undamaged and intact) conditions substantial margin exists between the computed peak $k_{\text{eff}} + 2\sigma$ value and the USL value of 0.92 (Section 3.1.1). Furthermore, it is seen from the results that fuel assembly bunching results in a negligible change in the established peak $k_{\text{eff}} + 2\sigma$ value, relative to the unbunched scenario. Thus any potential displacement of fuel assemblies within their compartments is inconsequential to criticality safety of the canister system under dry conditions.

The results of the calculations performed to evaluate an infinite planar array of PWR TAD canisters are presented in Figure 26.

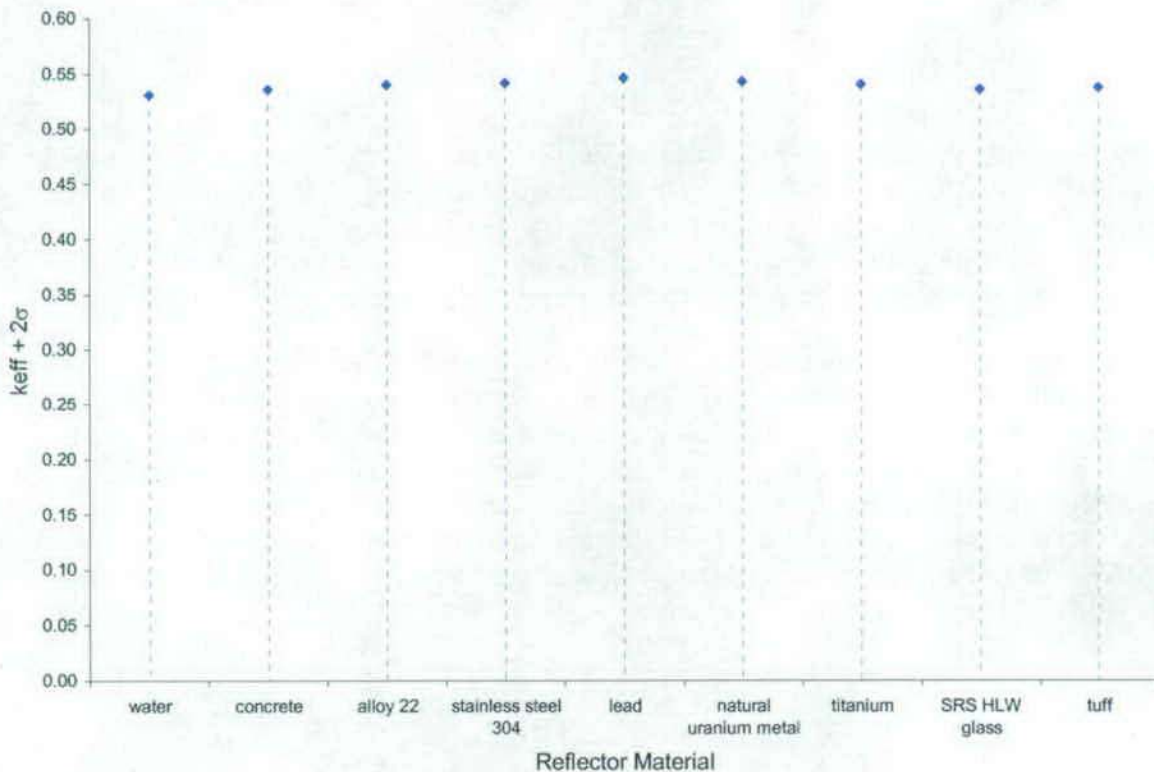

Source: Original

Figure 26. Variation of $k_{\text{eff}} + 2\sigma$ with Close Fitting Full-Thickness (I.E. 30 Cm) Axial Reflector Material, For Infinite Planar Array of Undamaged Dry PWR TAD Canisters, in Close Packed Triangular-Pitched Configuration, and with Each TAD Canister Containing Intact, Undamaged, Representative CSNF.

Based on the presented results in Figure 26, it is seen that the peak $k_{\text{eff}} + 2\sigma$ value is observed when the infinite planar array of PWR TAD canisters are axially reflected with lead, stainless steel or natural uranium metal. Of these three limiting materials, stainless steel is the only material that could credibly be available in sufficient quantity to axially reflect an entire array of TAD canisters. Therefore, a stainless steel axial reflector is applied to the MCNP model of an infinite planar array of BWR TAD canisters. The result of the calculation performed to evaluate an infinite planar array of BWR TAD canisters is detailed in Table 25, along with the equivalent case from the PWR TAD canister calculation.

Table 25. Comparison of $k_{\text{eff}} + 2\sigma$ Values For Infinite Planar Array Of Undamaged Dry PWR And BWR TAD Canisters In Close Packed Triangular-Pitched Configuration With Full-Thickness (I.E. 30 Cm) Stainless Steel Axial Reflector, and with Each TAD Canister Containing Intact, Undamaged, Representative CSNF

TAD Canister Variant	Close Fitting 30 cm Thick Axial Reflector Material	TAD Canister Surface-Surface Spacing (cm)	$k_{\text{eff}} + 2\sigma$
PWR	Stainless Steel 304	0.0	0.54104
BWR	Stainless Steel 304	0.0	0.51201

From the results presented in Table 25, it is seen that under normal (i.e. dry, undamaged and intact) conditions, substantial margin exists between the computed peak $k_{\text{eff}} + 2\sigma$ value and the USL value of 0.92 (Section 3.1.1). Furthermore, examination of the results in Table 24 and Table 25, reveals that, under normal (i.e. dry, undamaged and intact) conditions, the TAD canisters are slightly more reactive in an array configuration, and that the PWR TAD canisters represent the limiting canister system, from a criticality safety viewpoint.

To confirm the expectation that the presence of moderator in the interstitial space between the TAD canisters in the canister infinite planar array scenario would reduce the calculated peak $k_{\text{eff}} + 2\sigma$ value, a further series of calculations are performed. From the trend established in Figure 27, it is seen that the presence of moderator external to, and between, the TAD canisters results in a decrease in the system reactivity. This trend is understood when realizing that the neutron absorption cross-section of iron (the predominant constituent element of steel) is highly susceptible to the incident neutron energy, increasing sharply with progressive softening of the neutron spectrum.

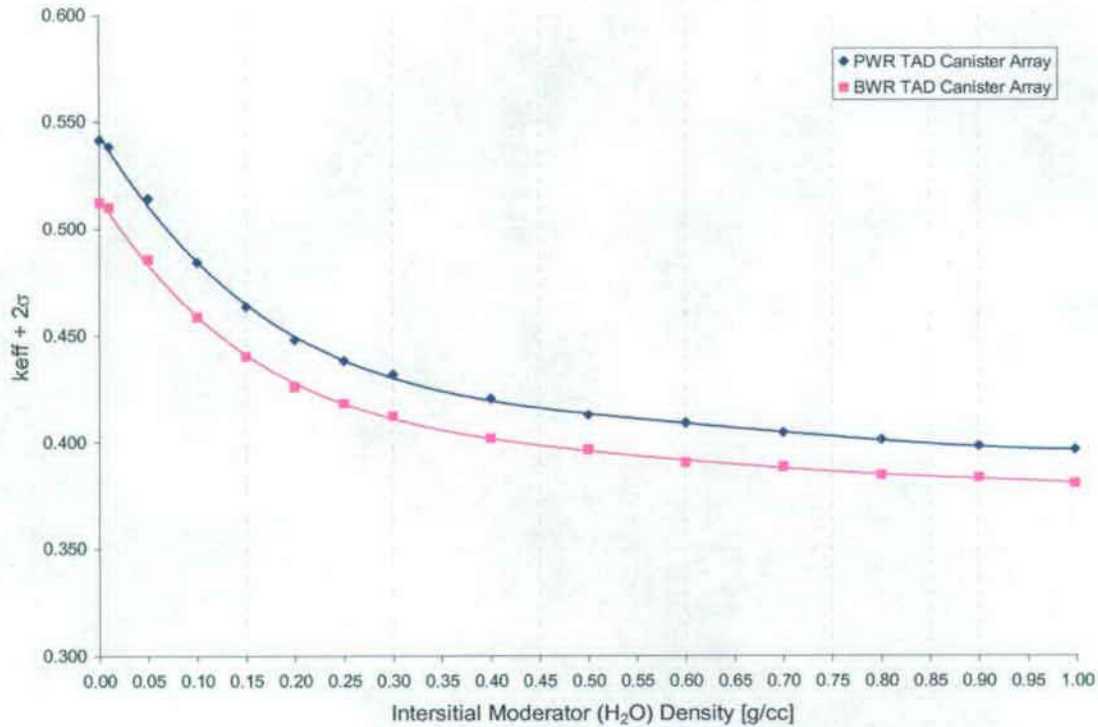

Source: Original

Figure 27. Variation of $k_{\text{eff}} + 2\sigma$ for Infinite Planar Array Of Undamaged Dry TAD Canisters In Close Packed Triangular-Pitched Configuration With Full-Thickness (I.E. 30 Cm) Stainless Steel Axial Reflector, with Each TAD Canister Containing Intact, Undamaged, Representative CSNF, and with Variable Density H₂O Moderator Situated in the Interstitial Space Between Each TAD Canister

7.1.1.2 Subsurface Facility

The criticality safety process for evaluating the TAD canister-based systems under normal conditions in the Subsurface facility is described in detail in Section 6.3.1.2.

The results of the PWR TAD canister emplacement configuration calculations performed based on the process defined in Section 6.3.1.2 are presented in Figure 28. The results of the PWR and BWR TAD canister emplacement configuration calculations, with the limiting reflector material established in Figure 28, are detailed in Table 26.

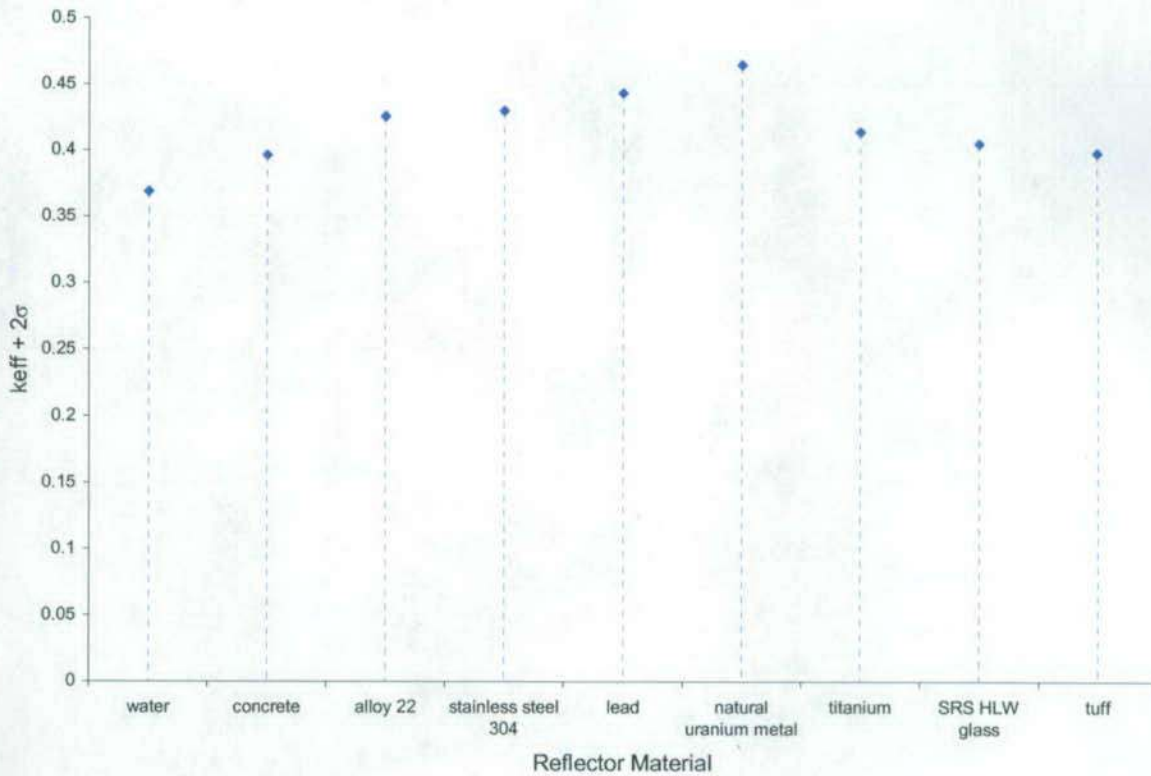

Source: Original

Figure 28. Variation of $k_{eff} + 2\sigma$ with Close Fitting Full-Thickness (I.E. 30 Cm) Reflector Material, for Infinitely Long Row (Drift) of Undamaged Dry PWR TAD Canisters, Containing Intact, Undamaged, Representative CSNF

Table 26. Comparison of $k_{eff} + 2\sigma$ Values for Infinitely Long Row (Drift) of Undamaged Dry PWR TAD Canisters, Containing Intact, Undamaged, Representative CSNF, and with Close Fitting Full-Thickness (I.E. 30 Cm) Natural Uranium Metal Reflection Applied to Cylindrical Surface of Canisters

TAD Canister Variant	Close Fitting 30 cm Thick Reflector Material	$k_{eff} + 2\sigma$
PWR	Natural Uranium Metal	0.46441
BWR	Natural Uranium Metal	0.45161

Based on the results presented in Table 26, it is seen that under normal conditions (i.e. emplacement of dry, undamaged and intact canisters containing intact, undamaged, CSNF), substantial margin exists between the computed peak $k_{eff} + 2\sigma$ value and the USL value of 0.92 (Section 3.1.1). As expected, the results demonstrate that the reactivity of the TAD canister

emplacement configuration is essentially equivalent to the reactivity of a single fully reflected canister.

7.1.2 Potential Off-Normal Conditions

All TAD canisters received and accepted into the surface and sub-surface facilities will be hermetically sealed, with a dry, intact, basket containing intact commercial spent nuclear fuel with a maximum initial enrichment of 5 wt % $^{235}\text{U}/\text{U}$. Deviation(s) from normal operating conditions in the surface facilities could potentially result in off-normal conditions that promote a compromise to the integrity, desiccation and geometry of the TAD canisters, their basket structure and their CSNF payload. Further to these potential facility-based off-normal conditions, manufacturing errors could potentially result in received TAD canisters containing improper quantities of borated stainless steel, or reduced boron content in the borated stainless steel panels associated with the TAD canister basket.

7.1.2.1 Surface Facilities and Intra-Site Operations

7.1.2.1.1 Detailed Parametric Study

7.1.2.1.1.1 Potential Off-Normal Scenario 1

Potential Off-Normal Scenario 1 considers:

- Progressive canister basket deformation (i.e. flux trap gap collapse),
- Progressive fuel assembly deformation (i.e. birdcaging), and
- Progressive flooding of the TAD canister with water.

The results of the potential off-normal scenario 1 calculations are presented in Figure 38 through Figure 43 (Attachment I) for the PWR TAD canister, and Figure 44 through Figure 49 (Attachment II), for the BWR TAD canister. An interpolation of the raw results, to establish the maximum safe moderator volume as a function of the basket/fuel assembly damage condition, is presented in Figure 29 and Figure 30 for the PWR and BWR TAD canisters, respectively.

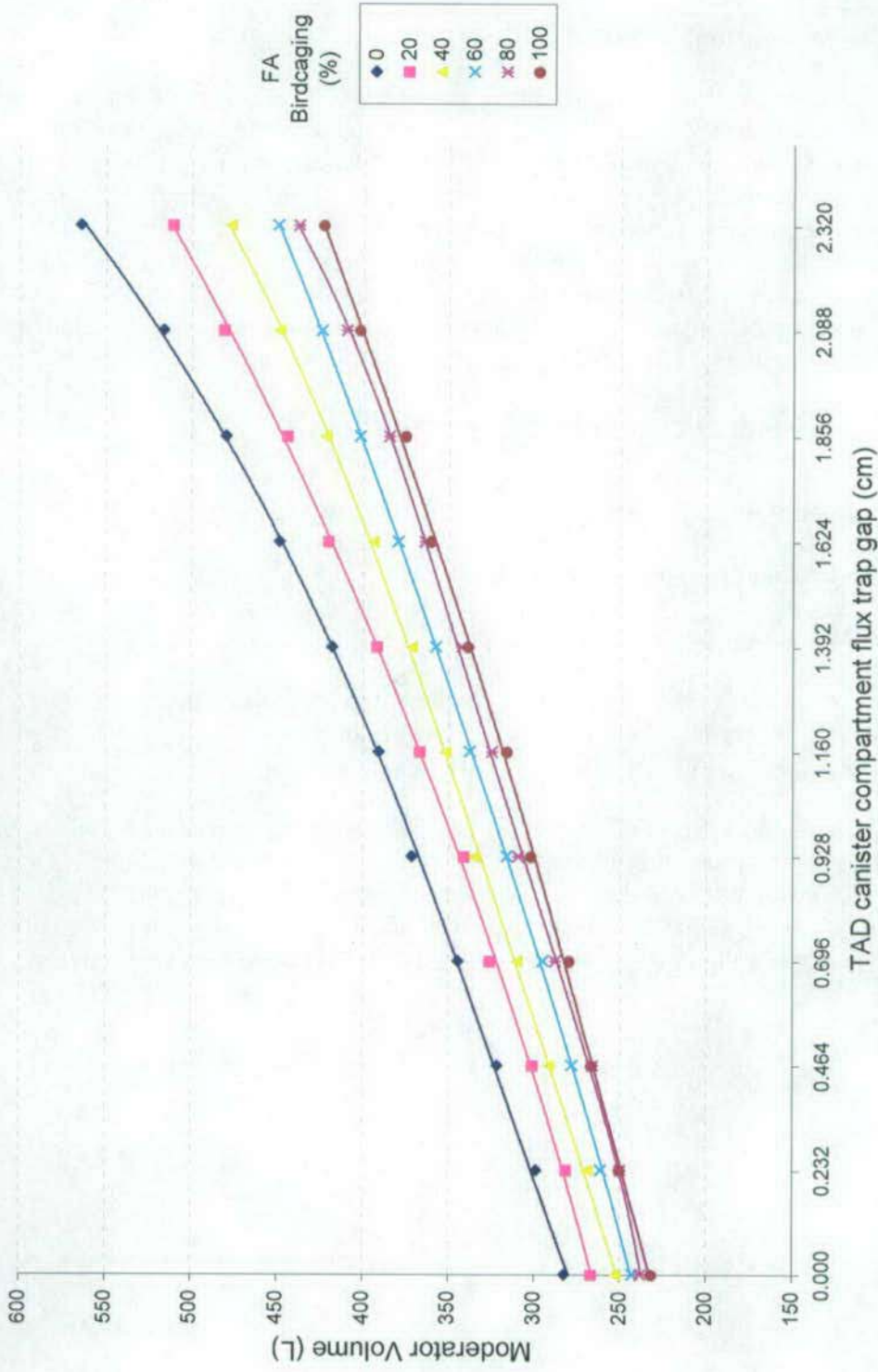

Source: Original

Figure 29. Maximum Safe Moderator (H₂O) Volume as Function of Fuel Assembly Birdcaging, and Compartment Flux Trap Gap, for Single Damaged, Partially Flooded PWR TAD Canister with 30cm Thick Close Fitting Steel Reflector

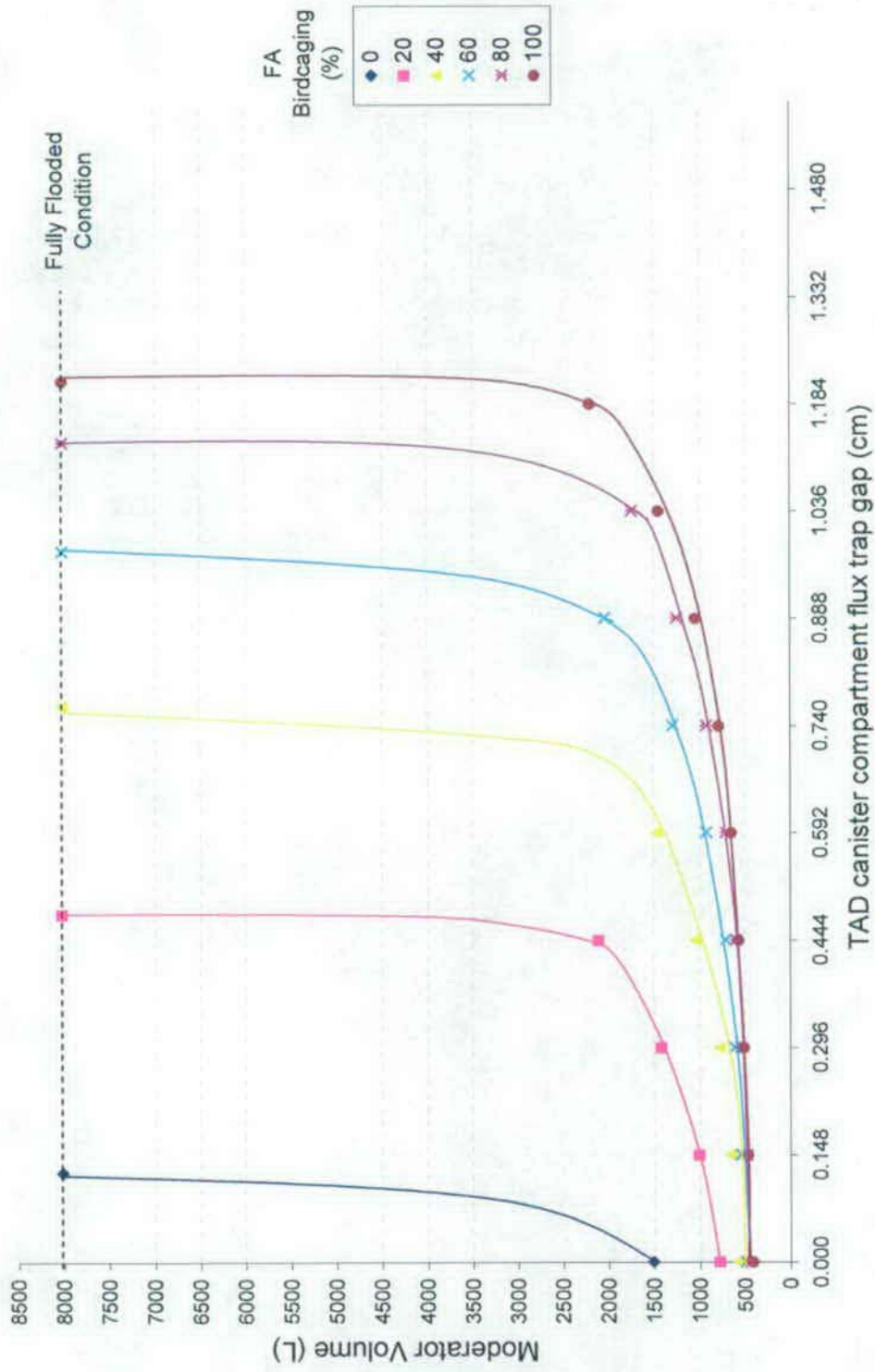

Source: Original

Figure 30. Maximum Safe Moderator (H₂O) Volume as Function of Fuel Assembly Birdcaging, and Compartment Flux Trap Gap, for Single Damaged, Partially Flooded BWR TAD Canister with 30cm Thick Close Fitting Steel Reflector

7.1.2.1.1.2 Potential Off-Normal Scenario 2

Potential Off-Normal Scenario 2 considers:

- Progressive canister basket deformation (i.e. flux trap gap collapse),
- Maximum fuel assembly deformation (i.e. birdcaging),
- Progressive reduction of the neutron absorber content of the canister basket, and
- Progressive flooding of the TAD canister with water.

The results of the potential off-normal scenario 2 calculations are presented in Figure 50 through Figure 60 (Attachment II) for the PWR TAD canister, and Figure 61 through Figure 71 (Attachment II), for the BWR TAD canister. An interpolation of the raw results, to establish the maximum safe moderator volume as a function of the basket damage condition and neutron absorber content, is presented in Figure 29 and Figure 30 for the PWR and BWR TAD canister, respectively.

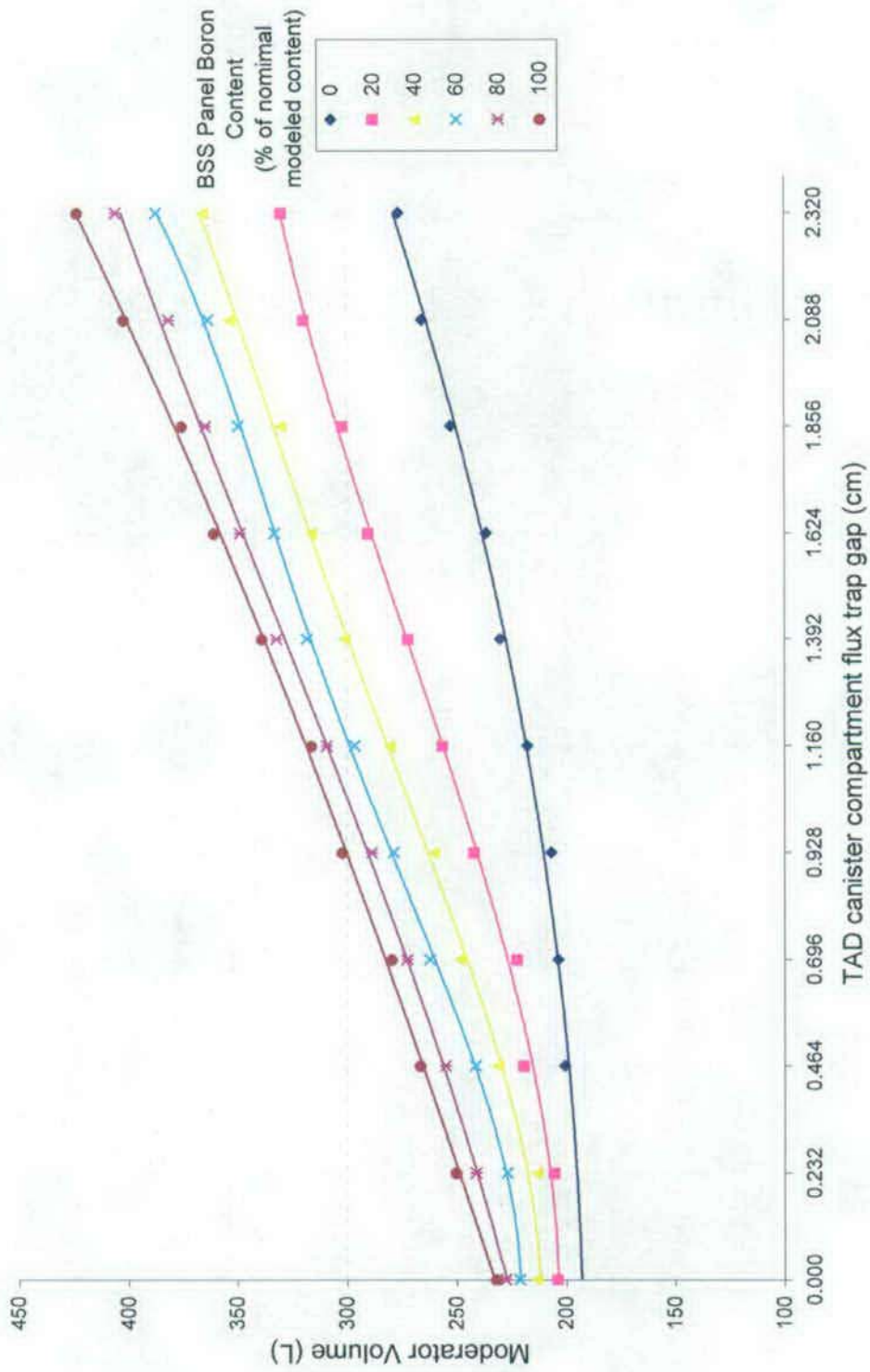

Source: Original

Figure 31. Maximum Safe Moderator (H₂O) Volume as Function of Canister BSS Panel Boron Content and Compartment Flux Trap Gap, for Single Damaged, Partially Flooded PWR TAD Canister with 30cm Thick Close Fitting Steel Reflector

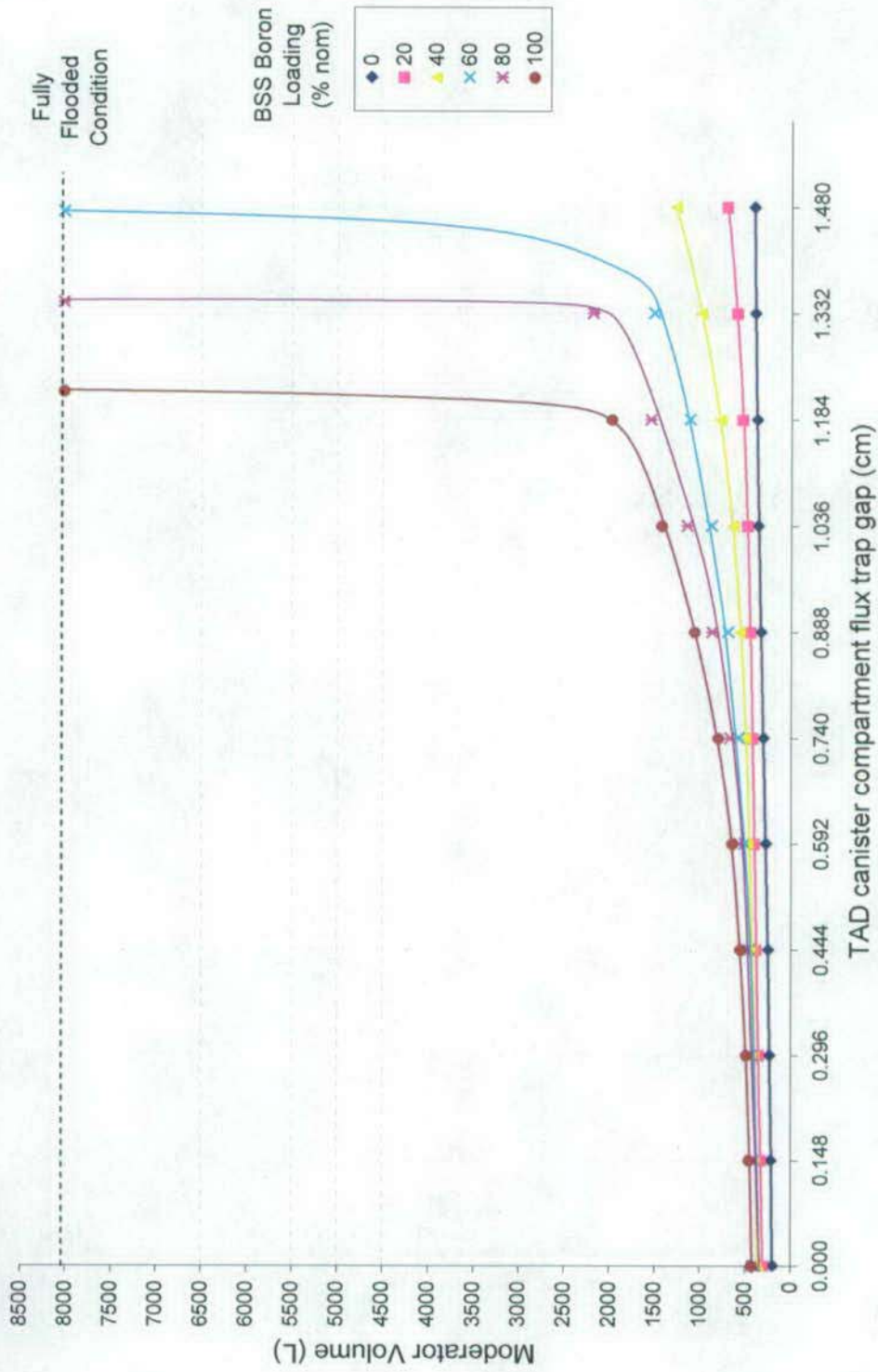

Source: Original

Figure 32. Maximum Safe Moderator (H₂O) Volume as Function of Canister BSS Panel Boron Content and Compartment Flux Trap Gap, for Single Damaged, Partially Flooded BWR TAD Canister with 30cm Thick Close Fitting Steel Reflector

7.1.2.1.1.3 Potential Off-Normal Scenario 3

Potential Off-Normal Scenario 3 considers:

- Progressive canister basket deformation (i.e. flux trap gap collapse),
- Progressive fuel assembly deformation (i.e. birdcaging),
- Progressive fuel release (i.e. fuel break-up), and
- Progressive flooding of the TAD canister with water.

The results of the precursor potential off-normal scenario 3 calculation (to establish the optimum fuel-water sludge concentration for an unconstrained moderator volume scenario) are presented in Figure 33. The data is based on a model of the PWR TAD canister with no basket or fuel damage, but with an entrained moderator volume of 500 liters, into which 5% of the total mass of fuel contained within the canister is homogenized at the base of the canister. Based on the results presented in Figure 33, it is seen that a reactivity peak is observed with an optimum fuel-water sludge concentration of approximately 1.2 g(UO₂)/cc.

The results of the main potential off-normal scenario 3 calculations are presented in Figure 72 through Figure 77 (Attachment III) for the 1% fuel release fraction scenario, Figure 78 through Figure 83 (Attachment III) for the 3% fuel release fraction scenario, and Figure 84 through Figure 89 (Attachment III) for the 5% fuel release fraction scenario. An interpolation of the raw results, to establish the maximum safe moderator volume as a function of the basket/fuel assembly damage condition and fuel release fraction considered, is presented in Figure 34. For comparison purposes, the results of the potential off-normal scenario 1 calculations are also presented, which correspond to the 'no fuel release' scenario.

Based on the trends established in Figure 34 it is seen that the maximum safe moderator volume is significantly more sensitive to damage scenarios that promote flux trap gap closure, than scenarios that lead to fuel assembly birdcaging. The relative insensitivity of fuel assembly birdcaging on the maximum safe moderator volume is more clearly emphasized in Figure 35. From Figure 35 it is also seen that the maximum safe moderator volume becomes less sensitive to the fuel release fraction considered, as the canister compartment flux trap gap is reduced.

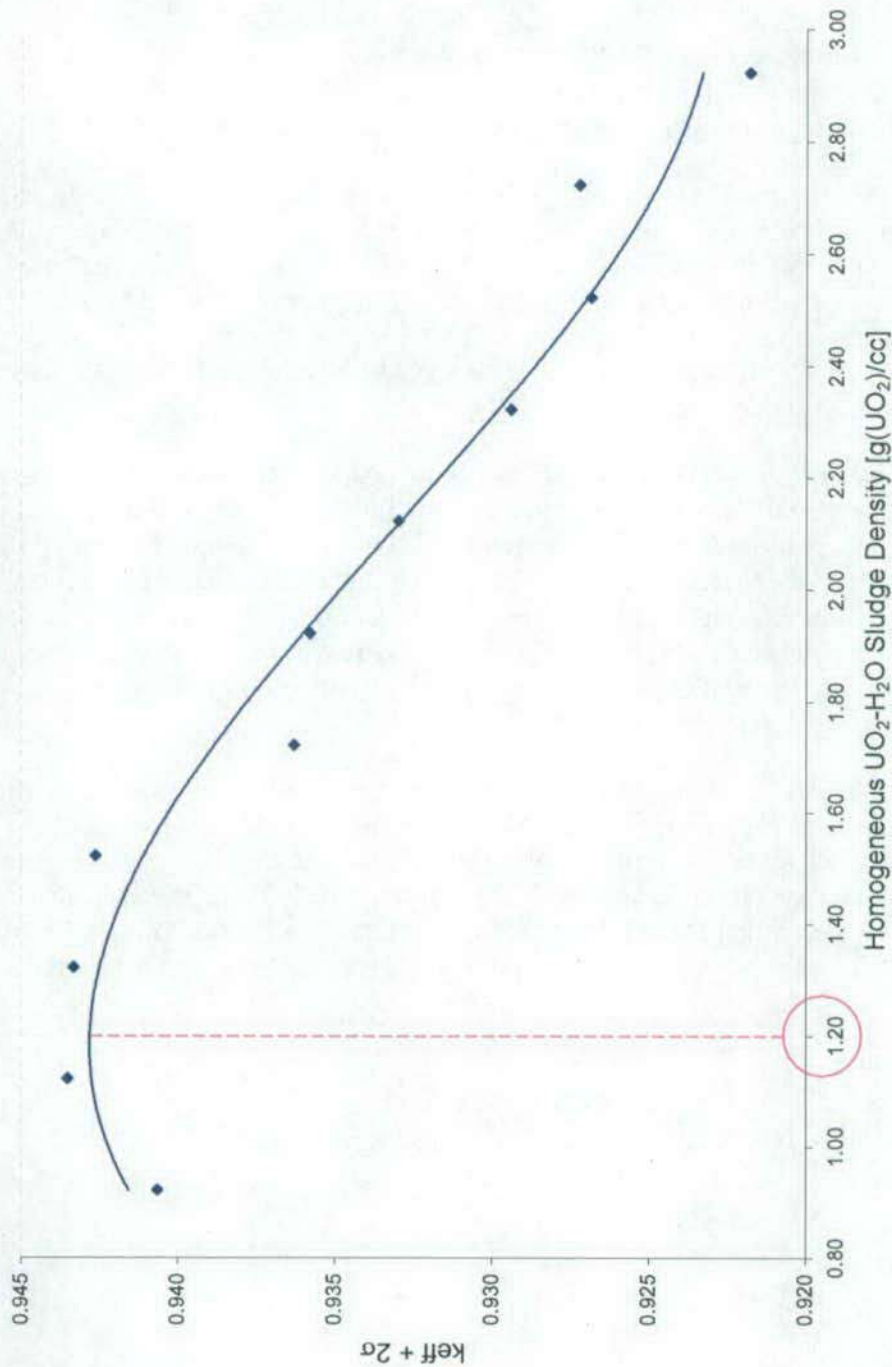

Source: Original

Figure 33. Variation of $k_{eff} + 2\sigma$ with Variation of Density of Homogeneous UO_2-H_2O Sludge (Based on 5% Fuel Release Positioned at Base of TAD Canister), for Single Undamaged, Partially Flooded PWR TAD Canister with 30cm Thick Close Fitting Steel Reflector

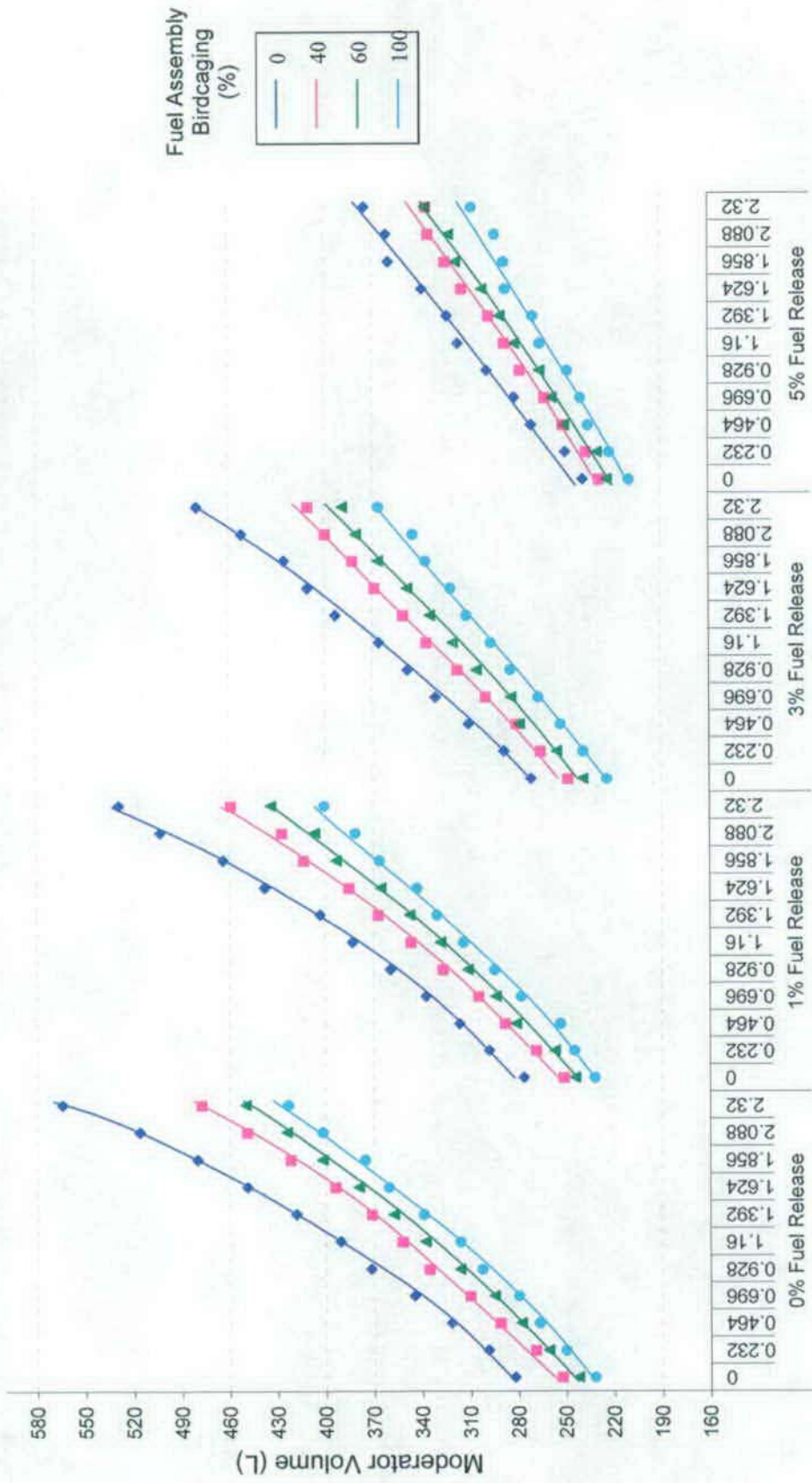

Source: Original

Figure 34. Maximum Safe Moderator (H₂O) Volume as Function of Fuel Assembly Birdcaging, Compartment Flux Trap Gap and Fuel Release Fraction, for Single Damaged, Partially Flooded PWR TAD Canister with 30cm Thick Close Fitting Steel Reflector

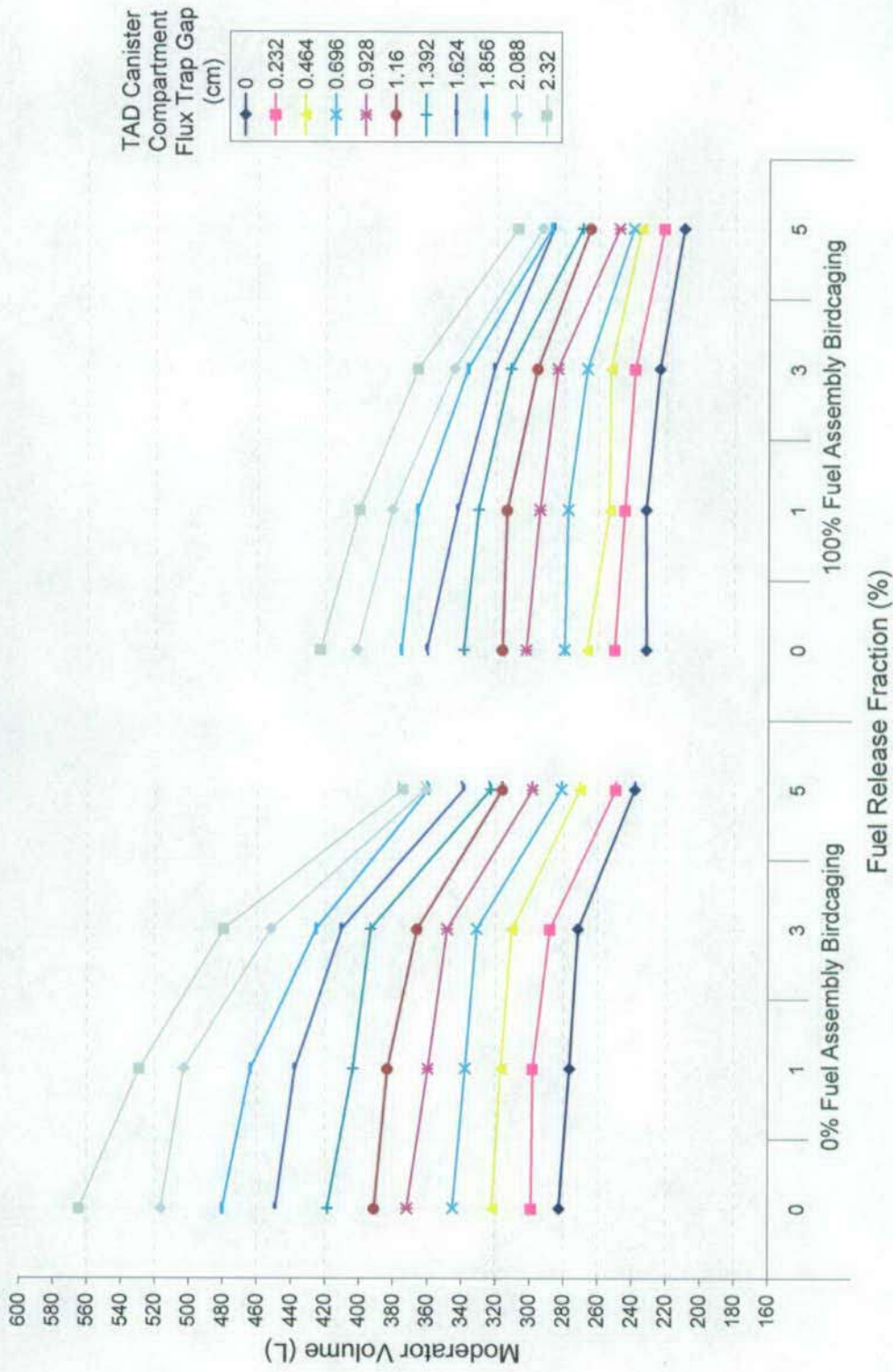

Source: Original

Figure 35. Maximum Safe Moderator (H₂O) Volume as Function of Fuel Assembly Birdcaging, Compartment Flux Trap Gap and Fuel Release Fraction, for Single Damaged, Partially Flooded PWR TAD Canister with 30cm Thick Close Fitting Steel Reflector

7.1.2.1.2 Ancillary Study

The ancillary potential off-normal conditions analysis supplements the detailed parametric study described in Section 6.3.2.1.1 and evaluated in Section 7.1.2.1.1. The ancillary study quantifies the effectiveness of various reflecting media, which could differ from the trend established in the normal conditions analysis due to the presence of moderator in the off-normal conditions models. The ancillary analysis also investigates the effect of grouping **multiple** damaged TAD canisters within an array, in addition to the effect of intrusion of an alternate moderator (hydraulic fluid) into the canister cavity.

7.1.2.1.2.1 Reflecting Media

The results of the calculations performed for single PWR and BWR TAD canisters exhibiting maximum fuel assembly birdcaging, complete compartment flux trap gap closure, and partial entrainment of water moderator are presented in Figure 36 and Figure 37. It is seen from the results presented that stainless steel is amongst the most onerous reflector materials for damaged, partially moderated, TAD canisters. Based on the very small change in k_{eff} ($< 1\%$) between the worst case reflector material (full theoretical density lead) and stainless steel, the detailed potential off-normal conditions calculations reported in Section 7.1.2.1.1 (which are based on a 30 cm thick close-fitting stainless steel reflector) are considered to bound reflection conditions achievable for TAD canisters within the surface facilities.

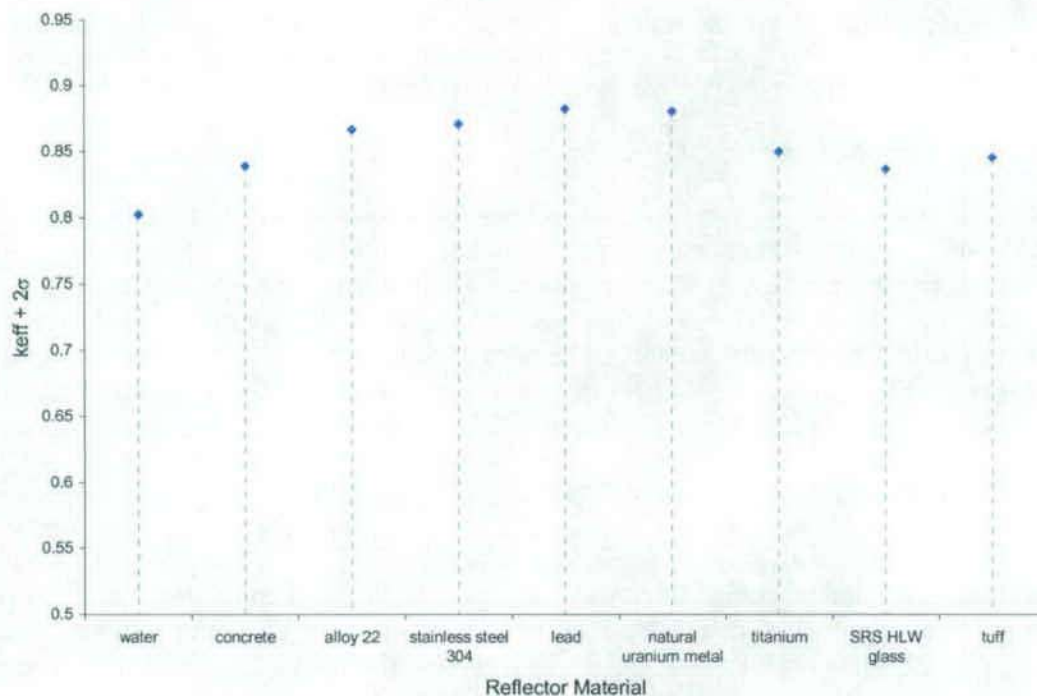

Source: Original

Figure 36. Variation of $k_{\text{eff}} + 2\sigma$ with Close Fitting Full-Thickness (I.E. 30 cm) Reflector Material, for Single Damaged (Maximum Flux Trap Gap Collapse) and Partially Flooded (200 Liters Water Moderator) PWR TAD Canister Containing Intact, Damaged (Maximum Fuel Assembly Birdcaging), Representative CSNF

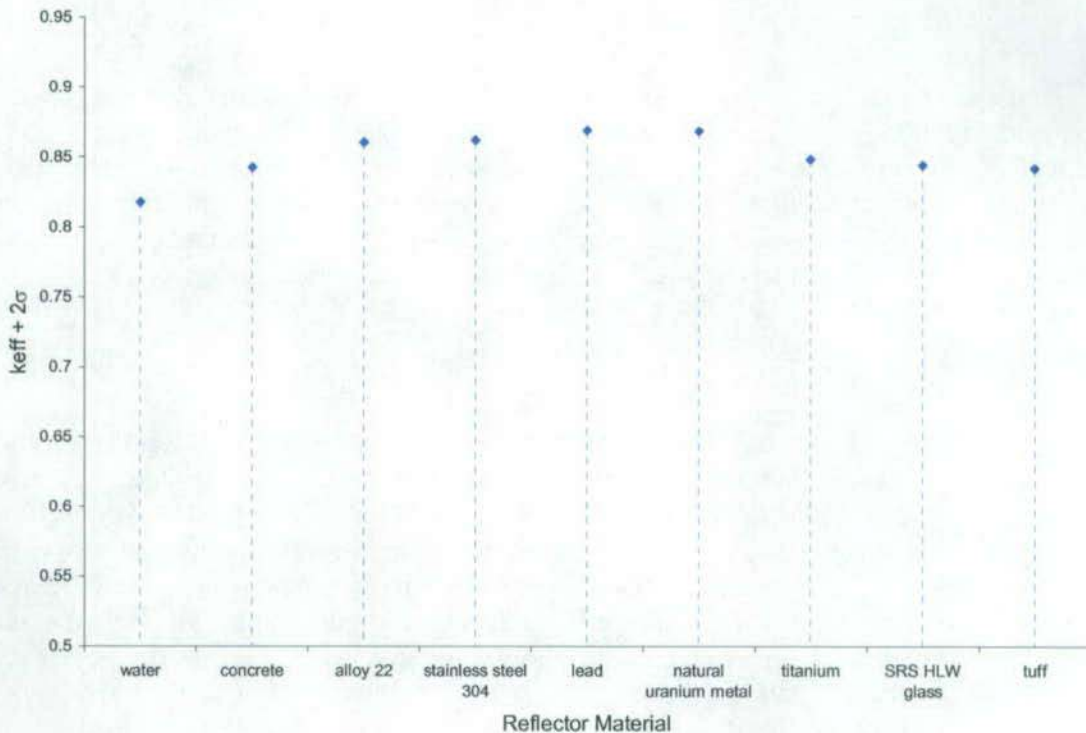

Source: Original

Figure 37. Variation of $k_{eff} + 2\sigma$ with Close Fitting Full-Thickness (I.E. 30 cm) Reflector Material, for Single Damaged (Maximum Flux Trap Gap Collapse) and Partially Flooded (300 Liters Water Moderator) BWR TAD Canister Containing Intact, Damaged (Maximum Fuel Assembly Birdcaging), Representative CSNF

7.1.2.1.2.2 Damaged Canister Array

The results of the calculations performed for an infinite planar array of TAD canisters, with each canister exhibiting maximum fuel assembly birdcaging and complete compartment flux trap gap closure, are presented in Table 27. The corresponding water moderator content of each canister in the array is included in the table. For comparison, the equivalent results for the single canister calculations (**Potential Off-Normal Scenario 1**) reported in Section 7.1.2.1.1 are presented. It is seen from Table 27 that there is a negligible difference between the calculated values of $k_{eff} + 2\sigma$ for a single fully reflected damaged canister and an infinite planar array of damaged canisters.

7.1.2.1.2.3 Hydraulic Fluid Moderator

The result of the calculation performed for a single PWR TAD canister exhibiting maximum fuel assembly birdcaging, complete compartment flux trap gap closure, and entrainment of 200 liters of Polysiloxane fluid is presented in Table 28. For comparison, the equivalent result based on a 200 liter water moderator content (reported for **Potential Off-Normal Scenario 1** in Section 7.1.2.1.1) is presented. It is seen from Table 28 that there is a significant reduction in the calculated value of $k_{eff} + 2\sigma$ when the modeled water moderator is substituted for an equivalent volume of polysiloxane fluid.

Table 27. Comparison of $k_{\text{eff}} + 2\sigma$ Values for Damaged PWR and BWR TAD Canisters, with Each TAD Canister Containing Water Moderator and Intact, Representative CSNF, with Maximum Fuel Assembly Birdcaging and Complete Canister Compartment Flux Trap Gap Closure

TAD Canister Variant	Canister Model	TAD Canister Surface-Surface Spacing (cm)	Degree of FA Birdcaging (%)	Flux Trap Gap (cm)	Boron loading in BSS (%)	30 cm Thick Reflector Material	Water Moderator Volume (L)	$k_{\text{eff}} + 2\sigma$
PWR	Infinite Planar Array	0.0	100	0.0	100	Stainless Steel 304 (axially)	200	0.87603
PWR	Single Fully Reflected	N/A	100	0.0	100	Stainless Steel 304 (axially/radially)	200	0.87012
BWR	Infinite Planar Array	0.0	100	0.0	100	Stainless Steel 304 (axially)	300	0.8636
BWR	Single Fully Reflected	N/A	100	0.0	100	Stainless Steel 304 (axially/ radially)	300	0.86187

Table 28. Comparison of $k_{\text{eff}} + 2\sigma$ Values for Single Fully Reflected Damaged PWR TAD Canister Containing 200 Liters of Water or Polysiloxane Moderator and Intact, Representative CSNF, with Maximum Fuel Assembly Birdcaging and Complete Canister Compartment Flux Trap Gap Closure

TAD Canister Variant	Degree of FA Birdcaging (%)	Flux Trap Gap (cm)	Boron loading in BSS (%)	30 cm Thick Reflector Material	Moderator	Moderator Volume (L)	$k_{\text{eff}} + 2\sigma$
PWR	100	0.0	100	Stainless Steel 304 (axially)	Polysiloxane	200	0.75775
PWR	100	0.0	100	Stainless Steel 304 (axially/ radially)	Water	200	0.87012

7.1.2.2 Subsurface Facility

Operations conducted in the Subsurface facility concern the receipt and placement of loaded, sealed, waste packages containing CSNF, DOE SNF, naval SNF and HLW glass. The subcriticality of sealed waste packages positioned in the Subsurface facility emplacement drifts is demonstrated in Section 7.1.1.2 for waste packages containing TAD canister-based systems that conform to a normal (i.e. dry, undamaged and intact) condition. In the event of deviation(s) from normal conditions occurring subsequent to emplacement, but prior to permanent closure of the Subsurface facility, the integrity, desiccation and geometry of the TAD canisters located in their sealed waste packages could be compromised. However, based on the results of the calculations reported in Section 7.1.1.2, the reactivity of the TAD canisters in an emplacement configuration is essentially equivalent to the reactivity of a single fully reflected TAD canister. Because this trait is a result of the large length of the TAD canisters (which is essentially infinite from a neutron transport viewpoint), it is confidently judged that the established trait is independent of the canister condition considered (i.e. normal condition versus off-normal condition). Therefore, the Subsurface facility under off-normal conditions may be bounded by the single damaged TAD canister analysis reported in Section 7.1.2.1.

7.2 CONCLUSIONS

The results of the MCNP criticality safety calculations described in this document are presented in Section 7.1. Based on the results presented attributes of the TAD canister-based systems that are important to ensuring their subcriticality are established. These attributes can be categorized according to the criticality control parameter that is impacted. Based on the categorization presented below, it is seen that **Moderation** control is the underlying criticality control parameter for TAD canister-based systems containing CSNF with a maximum initial enrichment of 5 wt. % $^{235}\text{U}/\text{U}$. However, **Geometry** and **Neutron Absorber** control are also important because the design of the canister basket, including the associated neutron absorber panels, directly influence the maximum moderator volume that can be safely tolerated inside the TAD canister cavity in the event of a canister breach. On this basis, it is convenient to define the moderation limits for the PWR and BWR TAD canisters according to the geometry and neutron absorber condition prevalent. In this respect, the maximum safe moderator limits for the TAD canister-based systems, and their associated range of applicability (i.e. **Geometry** and **Neutron Absorber** condition), are detailed in Table 29. For clarity, 'conditions' are used to correlate physical conditions with corresponding moderator limits. It is noted that the moderator limits provided in Table 29 correspond to the limiting volumes derived from the PWR TAD canister calculations. Consequently, the established limits bound the actual maximum safe moderator volumes for the BWR TAD canister.

Geometry

Under all normal conditions the TAD canister systems feature dry intact CSNF, held within a dry intact basket. Based on these dry (i.e. unmoderated) conditions, substantial margin exists between the computed peak $k_{\text{eff}} + 2\sigma$ value (in the region of 0.5, Section 7.1.1) and the USL value of 0.92 (Section 3.1.1). Owing to the relatively low fissile enrichment of CSNF, any rearrangement of CSNF or basket material due to a process upset involving damage of a canister, but not including moderation of its content, will not result in an unsafe condition. However, for

process upsets involving damage of a canister including its breach and subsequent introduction of moderator, the geometry of the CSNF and basket material is important. In this respect, the geometry of the canister basket and CSNF directly influence the established moderation limits tolerable for the PWR and BWR TAD canisters.

Neutron Absorber

Under normal conditions the TAD canisters are completely dry, which results in a hard neutron spectrum. Under these dry, unmoderated conditions, the borated stainless steel neutron absorber panels associated with the TAD canister basket structure provide very limited neutron absorption, to the extent that their complete omission will not result in an unsafe condition. For the same reason, under potential off-normal conditions resulting in moderation of the canister content coincident with collapse of the canister fuel compartment flux trap gap, the effectiveness of the neutron absorber panels is significantly diminished. This trait is understood when it is realized that reduction in the TAD canister fuel compartment flux trap gap results in reduced neutron moderation (i.e. a harder neutron spectrum), and thus reduced neutron absorption. Consequent to the above analysis, it is seen that the neutron absorber panels associated with the TAD canisters are important to criticality safety in situations involving moderation (or partial moderation) of the TAD canister cavity. However, based on the calculation results documented, it is seen that under a complete loss of moderation control (e.g. full flooding of the TAD canister cavity), the provision of neutron absorber control is insufficient to ensure subcriticality for the PWR TAD canister design (with no basket/fuel damage) and is insufficient to ensure subcriticality for the BWR TAD canister design (with just minor basket/fuel damage). Therefore, neutron absorber control is important to criticality safety, but only in the context of influencing the moderation limits tolerable for the PWR and BWR TAD canisters.

Moderation

Under all normal conditions the TAD canister systems feature dry intact CSNF, held within a dry intact basket. Based on these dry (i.e. unmoderated) conditions, substantial margin exists between the computed peak $k_{\text{eff}} + 2\sigma$ value (in the region of 0.5, Section 7.1.1) and the USL value of 0.92 (Section 3.1.1). However, under potential off-normal conditions involving moderation (or partial moderation) of the TAD canister cavity, the USL could be exceeded. This is especially true for the PWR TAD canister, which exceeds the USL with only partial moderation and no basket/fuel damage. Consequently, moderation control is essential to preserving the subcriticality of the TAD canister-based systems in the surface and Subsurface facilities examined in this document.

Interaction

The infinite planar array configuration considered for undamaged TAD canisters in the criticality safety analysis bounds any foreseen neutron interaction conditions that could be realized in the surface facilities under normal conditions. Furthermore, the 'infinite row' configuration considered for TAD canisters in the criticality safety emplacement models bounds any foreseen neutron interaction conditions that could be realized in the sub-surface facility.

Although coincident damage of multiple TAD canisters is considered extremely unlikely (because canisters are handled individually), the ancillary criticality safety analysis reported in this document includes a model of an infinite planar array configuration of damaged TAD canisters. The calculation results demonstrate that an infinite planar array of damaged canisters is essentially equivalent to a single, fully reflected, damaged canister, with regards to the maximum safe moderator volume. Consequently, the established moderator limits reported in this document bound conditions under which multiple TAD canisters are simultaneously damaged and subject to moderator intrusion.

Based on the above discussion, interaction control is not important to ensuring the subcriticality of the TAD canister-based systems in the surface and Subsurface facilities examined in this document.

Reflection

The effect of reflection on the fuel assemblies is considered in the criticality safety calculations reported in this document. For all calculations performed, close fitting full-thickness (i.e. 30 cm) reflection is considered. In addition, a comprehensive range of reflector materials (Section 6.2.3.3) are examined to determine the limiting reflector condition. Consequently, the reflection conditions accounted for the criticality safety calculations are considered to bound any foreseen reflections conditions that could be realized in the surface and subsurface facilities examined in this document. Therefore, reflection control is not important to ensuring the subcriticality of the TAD canister-based systems in the surface and sub-surface facilities examined in this document.

Waste Form Characteristics

The characteristics of CSNF and the canisters in which it is transported, packaged, and stored, are fixed prior to the time of acceptance into the repository. This calculation considered bounding waste form parameters (summarized below). Therefore, waste form characteristics are bounded and do not need to be controlled. The specific bounding waste form parameters employed in this calculation include:

- 5 wt% enriched ^{235}U fresh fuel (i.e., maximum CSNF enrichment and no credit for burnup);
- UO_2 density of 10.751 g/cm^3 , i.e., 98% of full theoretical density;
- Use of full assembly length as active fuel length;
- No burnable poison;
- No credit for the presence of ^{234}U or ^{236}U absorbers;
- Fuel pellet stack modeled as a simple cylinder with no density correction for dished ends;
- Gap between fuel and clad filled with unborated water; and
- Simplified fuel assembly model neglecting spacer grids and end fittings.

Table 29. Summary of Calculated Maximum Safe Moderator Limits for TAD Canister-Based Systems and their Associated Range of Applicability

TAD Canister Condition	Criticality Control Parameter					Ref.
	Neutron Absorber	Geometry			Moderation	
	Absorber Reduction (%)	Degree of FA Birdcaging (%)	Flux Trap Gap Collapse (%)	Fuel Release Fraction (%)	Max. Safe Moderator Volume (L)	
Handling of an undamaged TAD canister	N/A	N/A	N/A	N/A	564	Figure 29
Staging of multiple undamaged TAD canisters	N/A	N/A	N/A	N/A	~564 ^d	Figure 29
Emplacement of undamaged TAD canisters in the Subsurface facility	N/A	N/A	N/A	N/A	>564 ^e	Figure 29
Axial impact resulting in FA birdcaging	N/A	0% 50% 100%	N/A ^a	N/A	564 463 423	Figure 29
Axial impact resulting in fuel release	N/A	N/A	N/A ^a	0% 1% 3% 5%	564 529 480 374	Figure 35
Axial impact resulting in FA birdcaging and fuel release	N/A	100%	N/A ^a	0% 1% 3% 5%	423 400 366 307	Figure 35
Horizontal impact resulting in flux trap gap collapse	N/A	N/A ^b	0% 50% 100%	N/A ^c	564 391 282	Figure 29
Concurrent horizontal and axial impacts resulting in maximum damage, without fuel release	N/A	100%	100%	N/A	232	Figure 29
Concurrent horizontal and axial impacts resulting in maximum damage, with fuel release	N/A	100%	100%	0% 1% 3% 5%	232 232 224 210	Figure 35
Receipt of a TAD canister with reduced neutron absorber content, with a subsequent axial impact, resulting in FA birdcaging	0% 50% 100%	100%	N/A ^a	N/A	423 376 276	Figure 31
Receipt of a TAD canister with reduced neutron absorber content, with subsequent concurrent horizontal and axial impacts resulting in maximum	0% 50% 100%	100%	100%	N/A ^c	232 217 192	Figure 31

TAD Canister Condition	Criticality Control Parameter					Ref.
	Neutron Absorber	Geometry			Moderation	
	Absorber Reduction (%)	Degree of FA Birdcaging (%)	Flux Trap Gap Collapse (%)	Fuel Release Fraction (%)	Max. Safe Moderator Volume (L)	
damage, without fuel release						

NOTES: ^a Flux trap gap collapse is considered to arise from a horizontal impact. An end-on impact, resultant from a vertical drop, would not be expected to cause a reduction in the flux trap gap. Refer to Figure 20 for an illustration of expected damage resultant from a horizontal impact.

^b Fuel assembly birdcaging refers to a condition where there is an increase in fuel pin pitch, and is considered to arise from an axial impact. A horizontal impact would be expected to have an opposite effect; i.e. reduce pin pitch. Refer to Figure 20 for an illustration of expected damage resultant from a horizontal impact.

^c Fuel break-up and release in the canister cavity is considered to arise from an end-on impact. A horizontal impact is considered to result in basket deformation and potential reduction in pin pitch but is not considered to result in fuel release.

^d The results of the criticality safety calculations performed for the damaged canister array (Table 27) demonstrate that for partially flooded canisters, the canister array model is practically equivalent to the single fully reflected damaged canister model, with regards to the maximum safe moderator volume. Therefore, it is confidently judged that an array of undamaged, but partially flooded, canisters is equivalent to a single fully reflected undamaged, but partially flooded, canister.

^e Although not explicitly analyzed, the maximum safe moderator volume per canister for canisters in an emplacement configuration is considered to be significantly greater than the maximum safe moderator volume established for a single fully reflected canister, due to the horizontal configuration of canisters in the sub-surface emplacement drifts.

Source: Original

ATTACHMENT I: POTENTIAL OFF-NORMAL SCENARIO 1 RESULTS

Potential Off-Normal Scenario 1 considers:

- Progressive canister basket deformation (i.e. flux trap gap collapse),
- Progressive fuel assembly deformation (i.e. birdcaging), and
- Progressive flooding of the TAD canister with water.

The results of the potential off-normal scenario 1 calculations are presented in Figure 38 through Figure 43 of this attachment for the PWR TAD canister, and Figure 44 through Figure 49 of this attachment, for the BWR TAD canister. An interpolation of the presented results, to establish the maximum safe moderator volume as a function of the basket/fuel assembly damage condition, is performed in the body of this document (Figure 29 and Figure 30 for the PWR and BWR TAD canister, respectively).

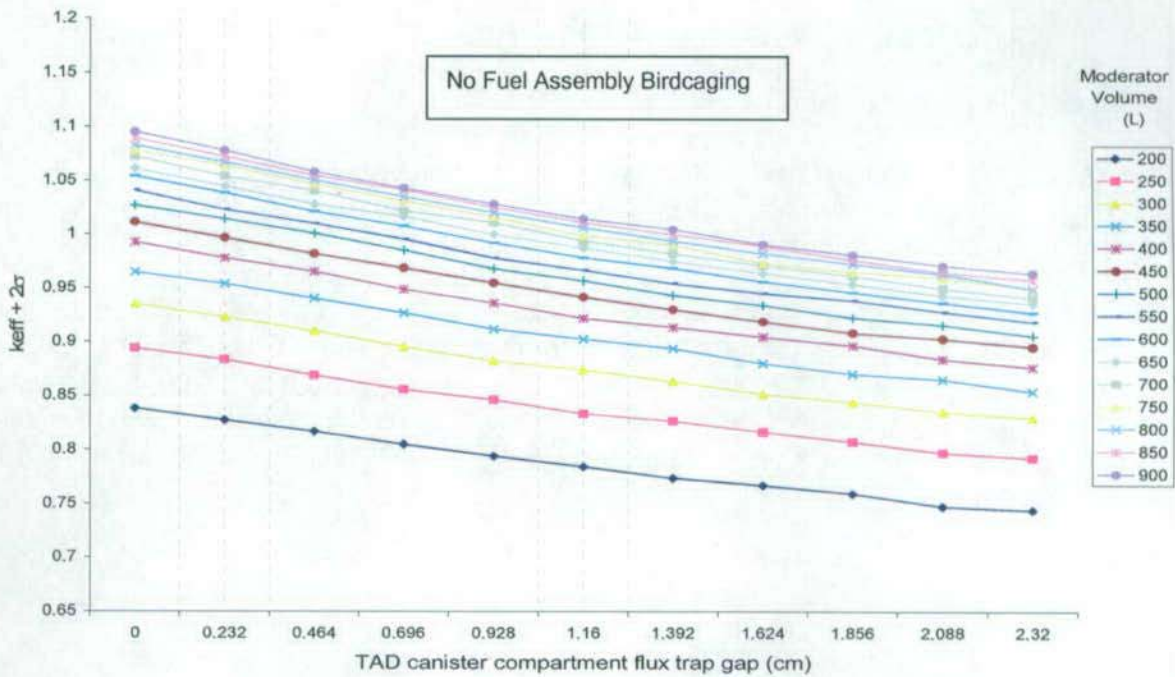

Source: Original

Figure 38. Variation of $k_{eff} + 2\sigma$ for Single Damaged and Partially Flooded PWR TAD Canister (With 30cm Thick Steel Reflector) Containing Intact Representative CSNF with No Fuel Deformation (0% Birdcaging)

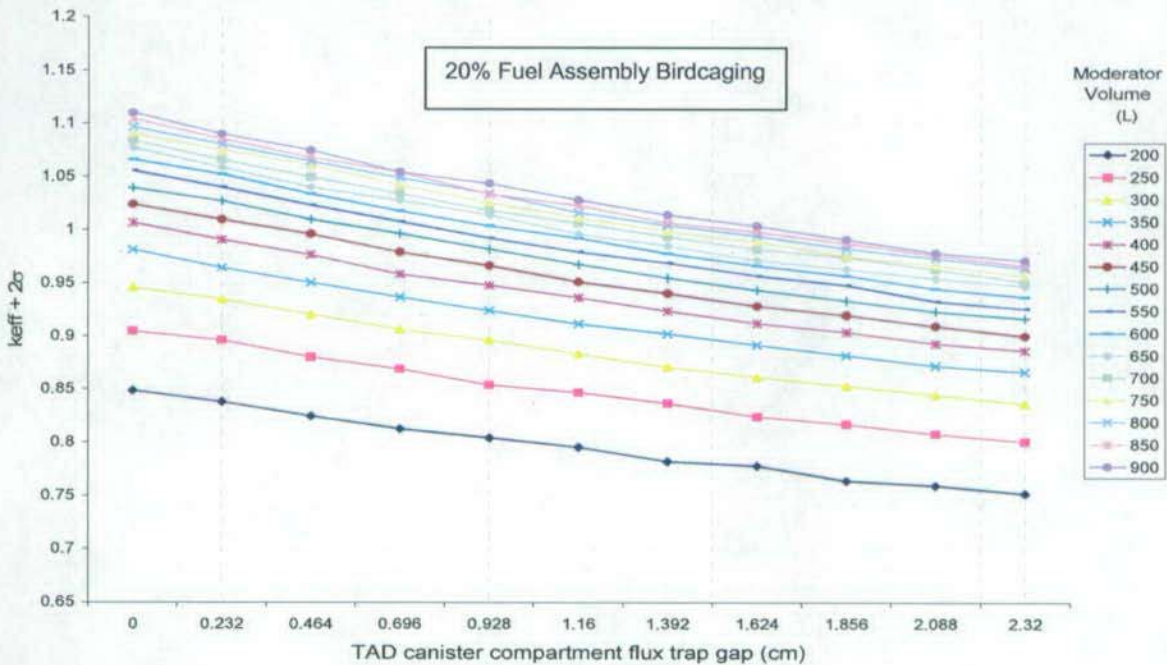

Source: Original

Figure 39. Variation of $k_{eff} + 2\sigma$ for Single Damaged and Partially Flooded PWR TAD Canister (with 30cm Thick Steel Reflector) Containing Intact Representative CSNF with Partial Fuel Deformation (20% Birdcaging)

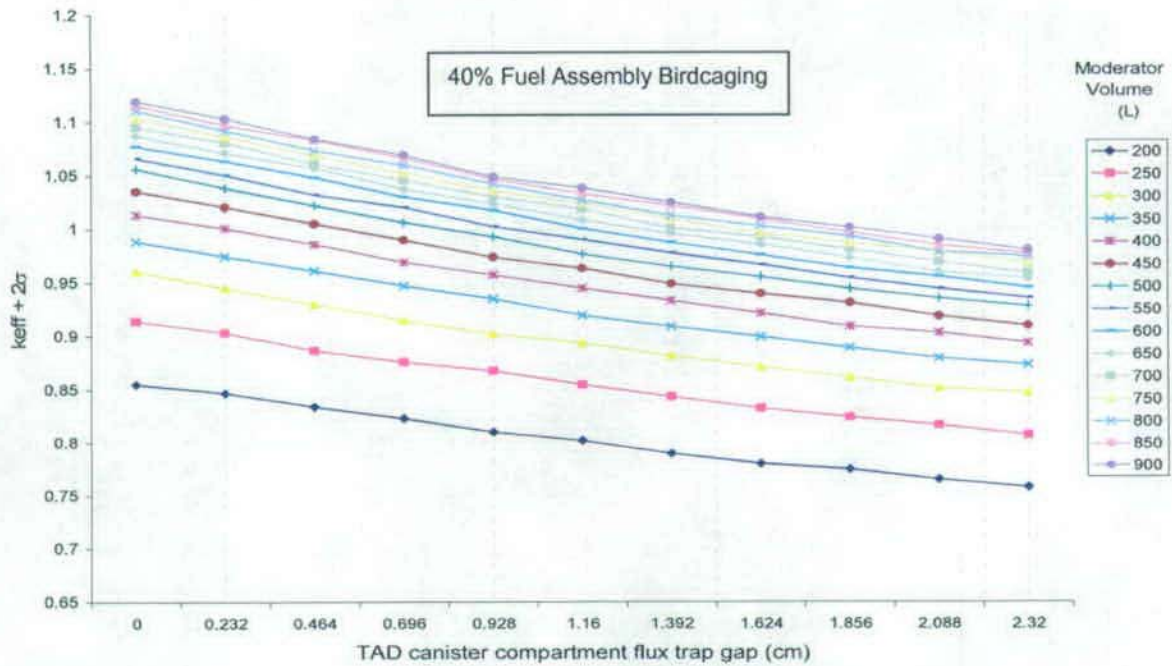

Source: Original

Figure 40. Variation of $k_{eff} + 2\sigma$ for Single Damaged, Partially Flooded PWR TAD Canister (with 30cm Thick Steel Reflector) Containing Intact Representative CSNF with Partial Fuel Deformation (40% Birdcaging)

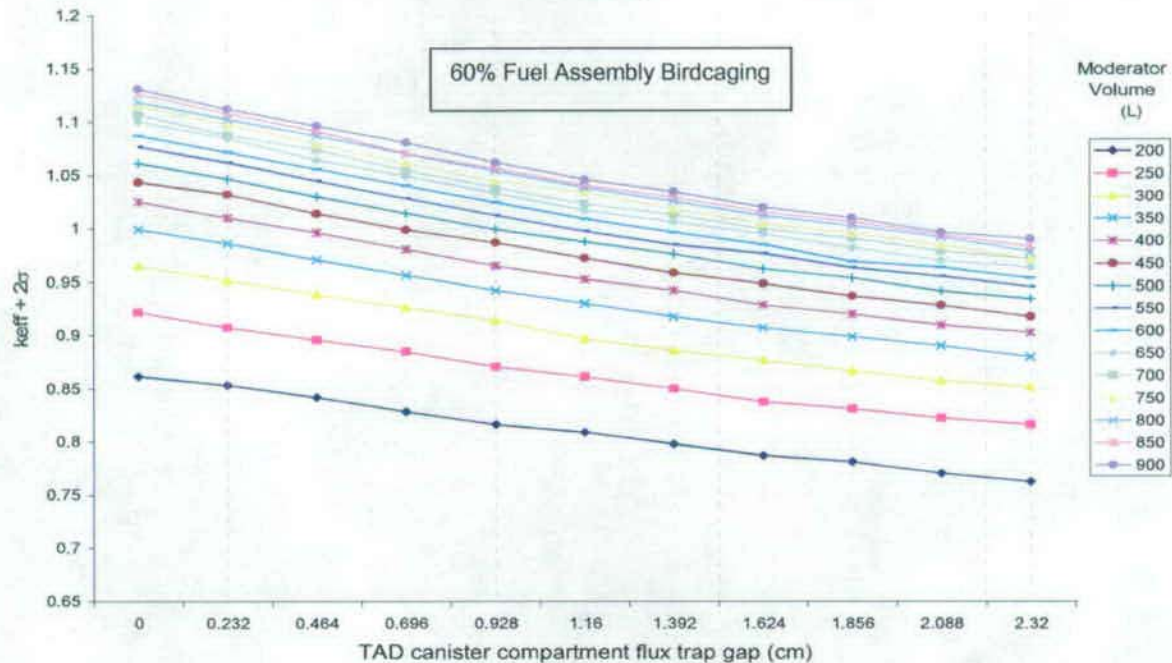

Source: Original

Figure 41. Variation of $k_{eff} + 2\sigma$ for Single Damaged, Partially Flooded PWR TAD Canister (with 30cm Thick Steel Reflector) Containing Intact Representative CSNF with Partial Fuel Deformation (60% Birdcaging)

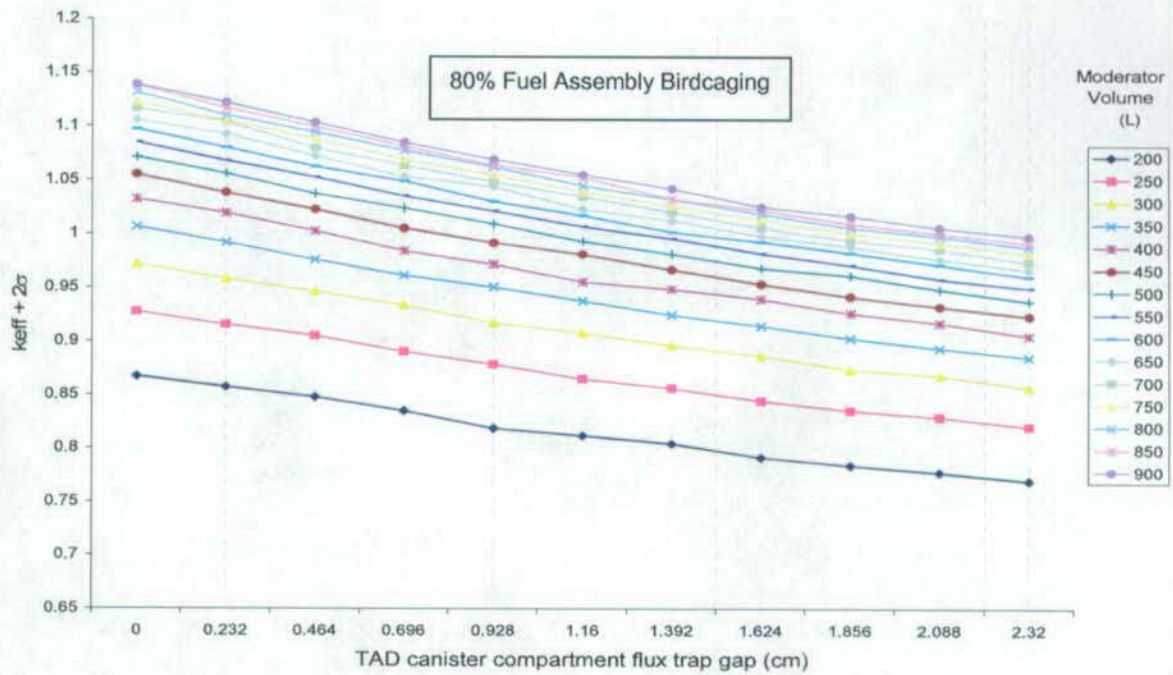

Source: Original

Figure 42. Variation of $k_{eff} + 2\sigma$ for Single Damaged, Partially Flooded PWR TAD Canister (With 30cm Thick Steel Reflector) Containing Intact Representative CSNF with Partial Fuel Deformation (80% Birdcaging)

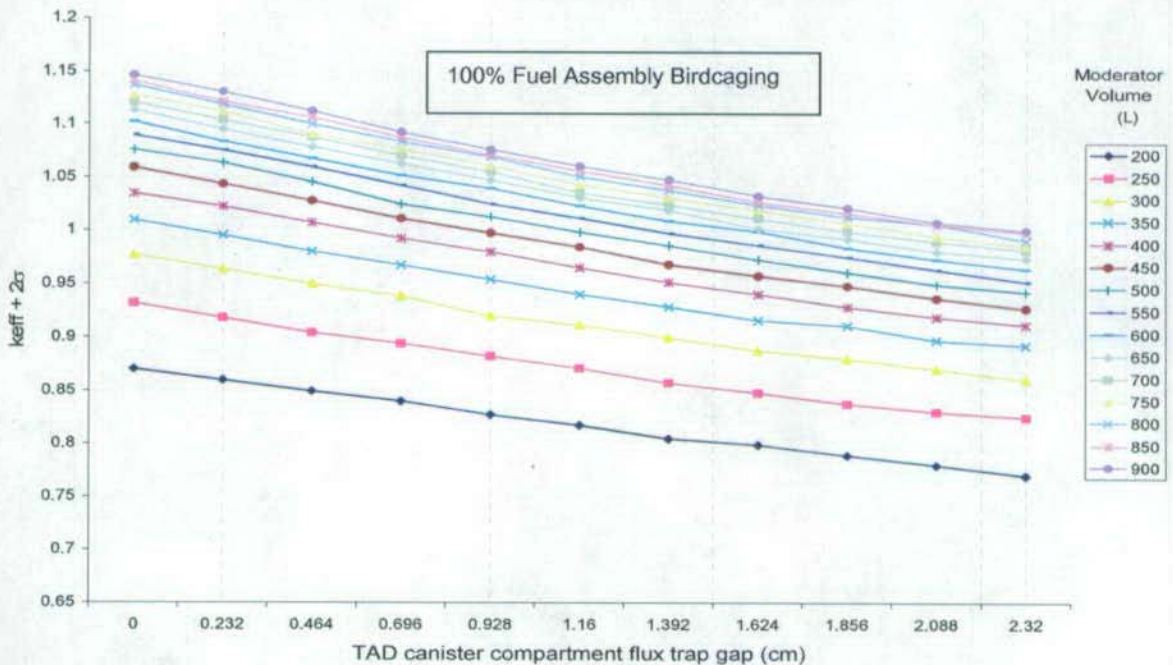

Source: Original

Figure 43. Variation of $k_{eff} + 2\sigma$ for Single Damaged, Partially Flooded PWR TAD Canister (with 30cm Thick Steel Reflector) Containing Intact Representative CSNF with Maximum Fuel Deformation (100% Birdcaging)

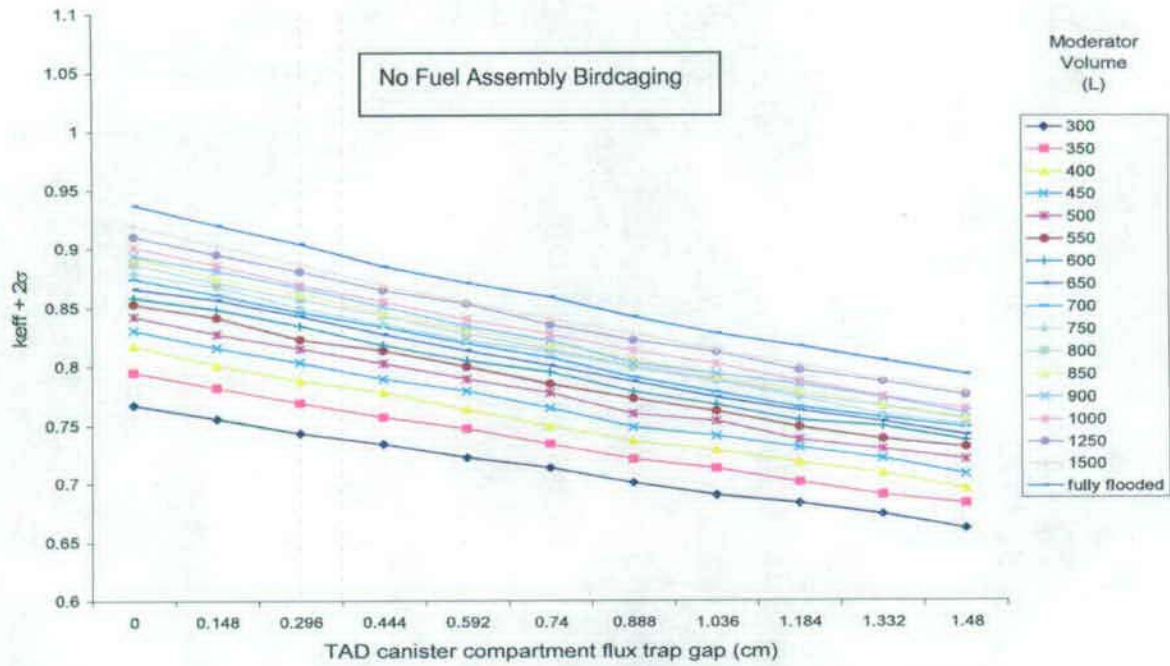

Source: Original

Figure 44. Variation of $k_{eff} + 2\sigma$ for Single Damaged, Partially Flooded BWR TAD Canister (with 30cm Thick Steel Reflector) Containing Intact Representative CSNF with No Fuel Deformation (0% Birdcaging)

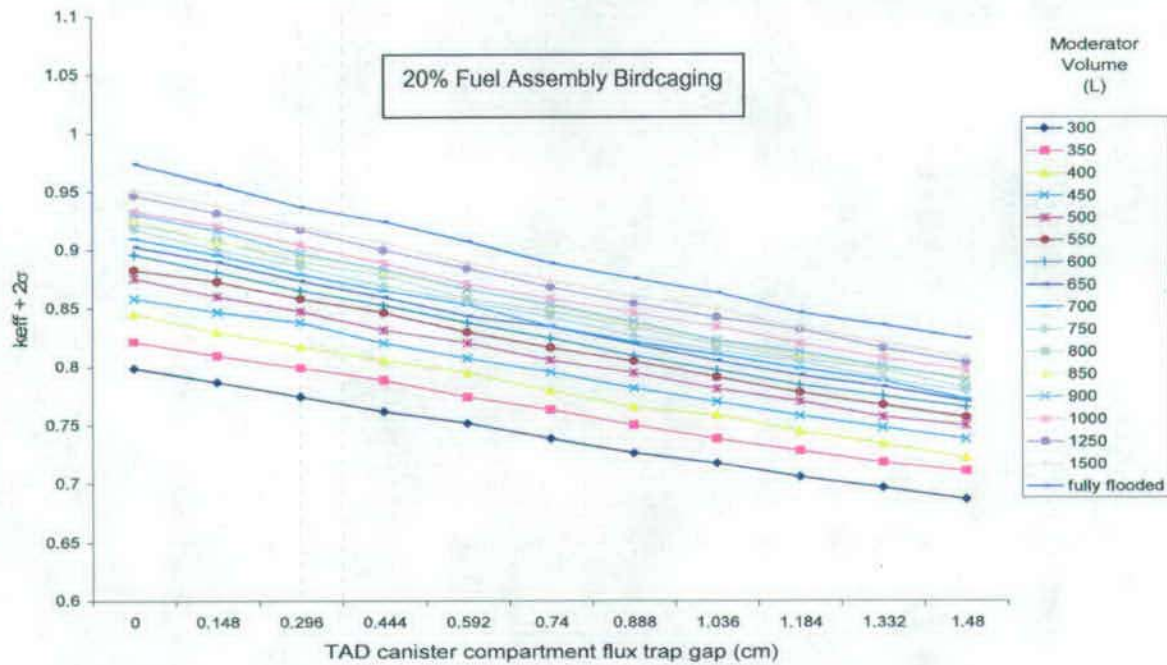

Source: Original

Figure 45. Variation of $k_{eff} + 2\sigma$ for Single Damaged, Partially Flooded BWR TAD Canister (with 30cm Thick Steel Reflector) Containing Intact Representative CSNF with Partial Fuel Deformation (20% Birdcaging)

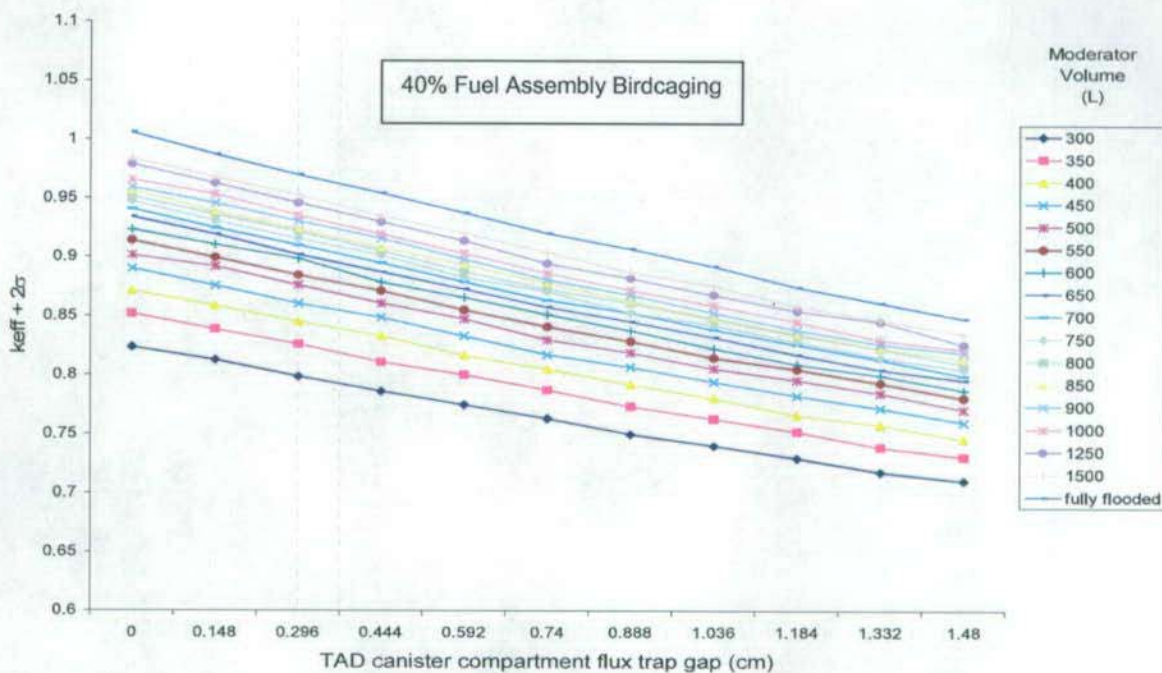

Source: Original

Figure 46. Variation of $k_{eff} + 2\sigma$ for Single Damaged, Partially Flooded BWR TAD Canister (with 30cm Thick Steel Reflector) Containing Intact Representative CSNF with Partial Fuel Deformation (40% Birdcaging)

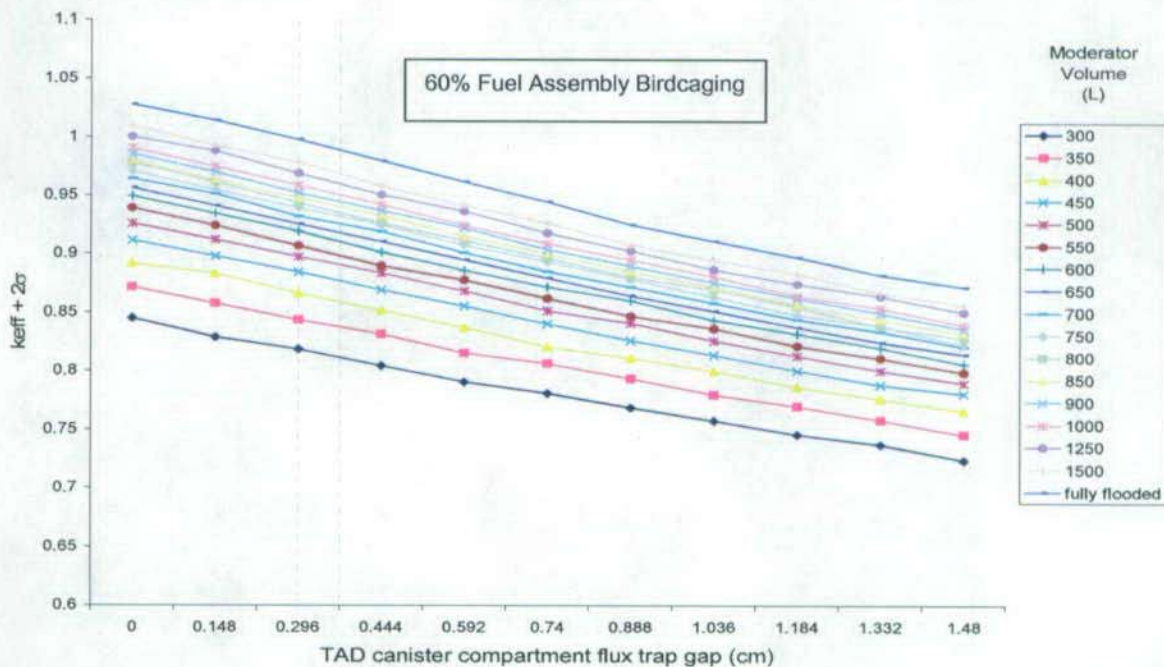

Source: Original

Figure 47. Variation of $k_{eff} + 2\sigma$ for Single Damaged, Partially Flooded BWR TAD Canister (with 30cm Thick Steel Reflector) Containing Intact Representative CSNF with Partial Fuel Deformation (60% Birdcaging)

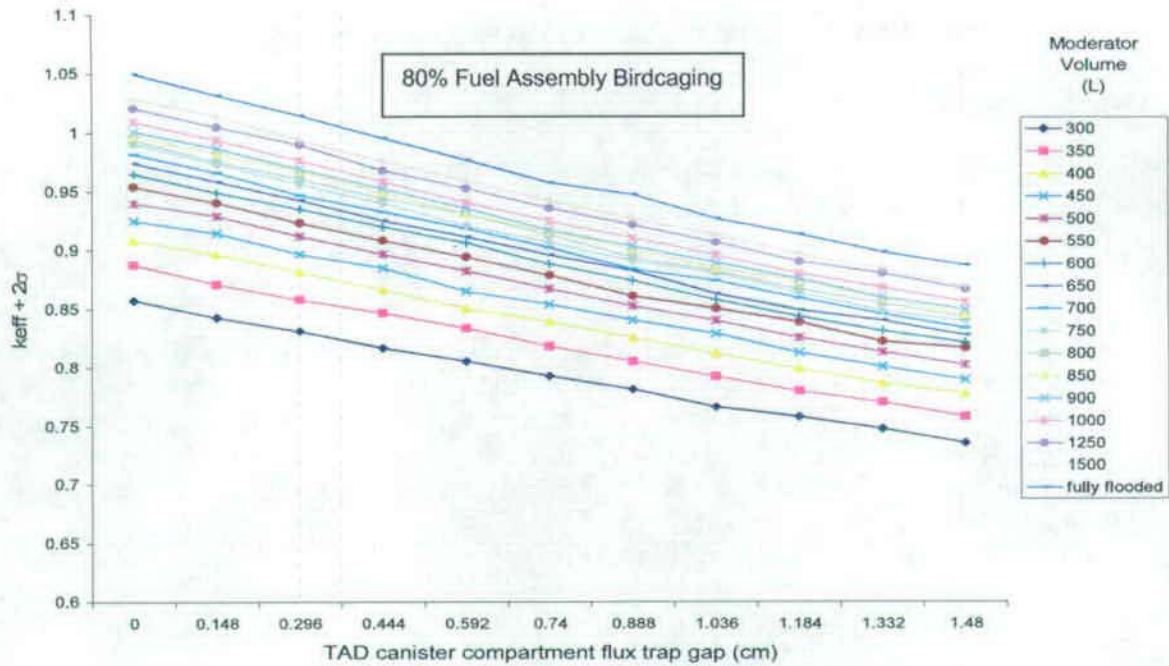

Source: Original

Figure 48. Variation of $k_{eff} + 2\sigma$ for Single Damaged, Partially Flooded BWR TAD Canister (with 30cm Thick Steel Reflector) Containing Intact Representative CSNF with Partial Fuel Deformation (80% Birdcaging)

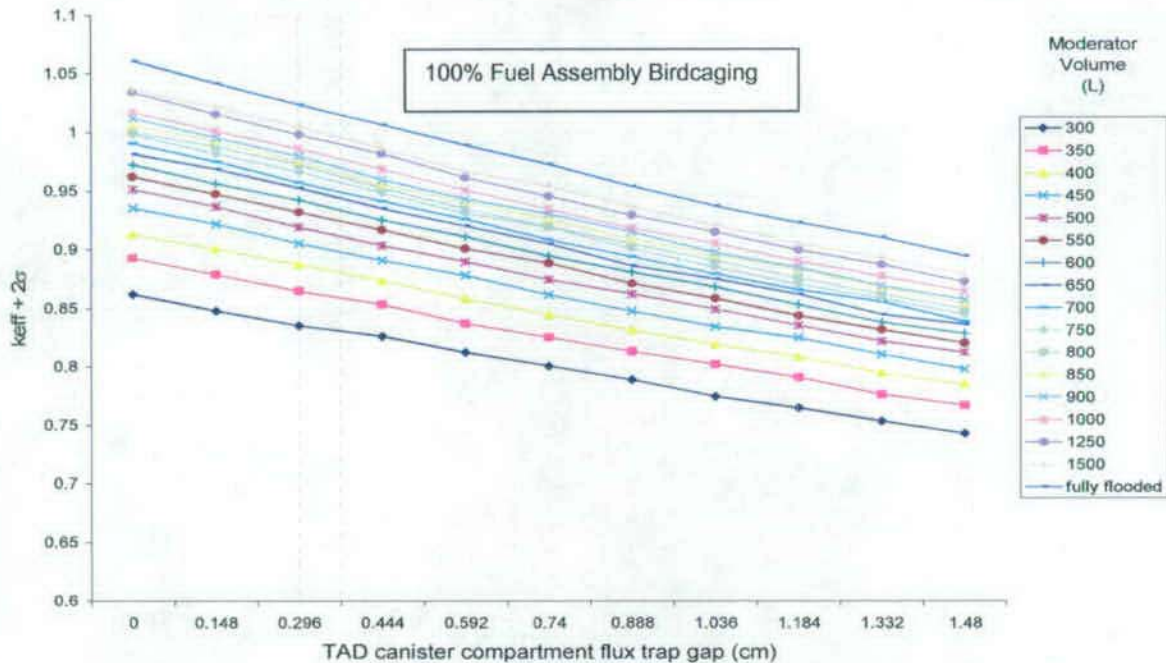

Source: Original

Figure 49. Variation of $k_{eff} + 2\sigma$ for Single Damaged, Partially Flooded BWR TAD Canister (with 30cm Thick Steel Reflector) Containing Intact Representative CSNF with Maximum Fuel Deformation (100% Birdcaging)

ATTACHMENT II: POTENTIAL OFF-NORMAL SCENARIO 2 RESULTS

Potential Off-Normal Scenario 2 considers:

- Progressive canister basket deformation (i.e. flux trap gap collapse),
- Maximum fuel assembly deformation (i.e. birdcaging),
- Progressive reduction of the neutron absorber content of the canister basket, and
- Progressive flooding of the TAD canister with water.

The results of the potential off-normal scenario 2 calculations are presented in Figure 50 through Figure 60 of this attachment for the PWR TAD canister, and Figure 61 through Figure 71 of this attachment, for the BWR TAD canister. An interpolation of the raw results, to establish the maximum safe moderator volume as a function of the basket damage condition and neutron absorber content, is performed in the body of this document (Figure 29 and Figure 30 for the PWR and BWR TAD canister, respectively).

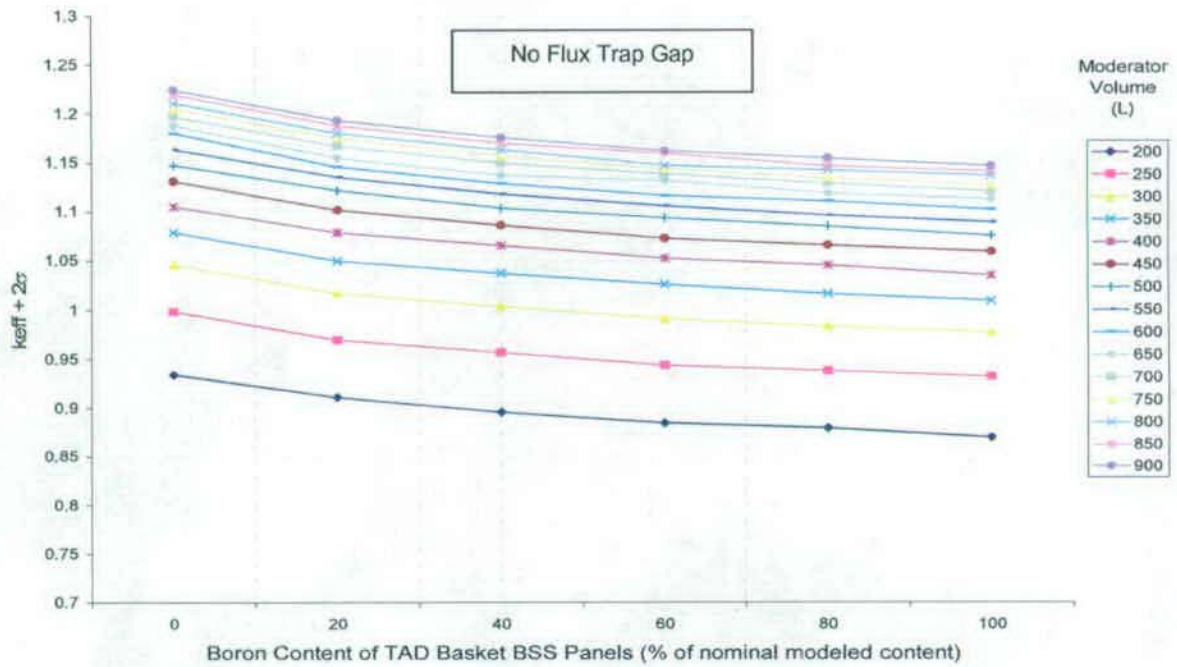

Source: Original

Figure 50. Variation of $k_{eff} + 2\sigma$ for Single Maximum Damaged (No Flux Trap Gap) and Partially Flooded PWR TAD Canister (with 30cm Thick Steel Reflector) Containing Intact Representative CSNF with Maximum Fuel Deformation (I.E. 100% Birdcaging)

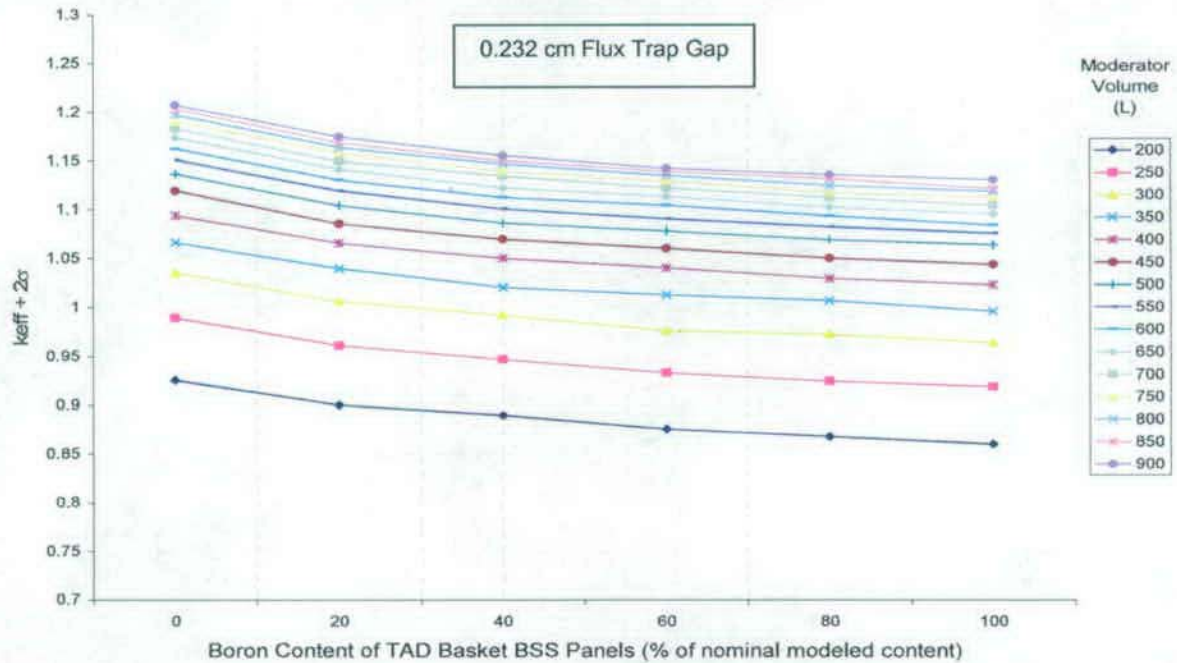

Source: Original

Figure 51. Variation of $k_{eff} + 2\sigma$ for Single Partially Damaged (0.232 Cm Flux Trap Gap) and Partially Flooded PWR TAD Canister (with 30cm Thick Steel Reflector) Containing Intact Representative CSNF with Maximum Fuel Deformation (I.E. 100% Birdcaging)

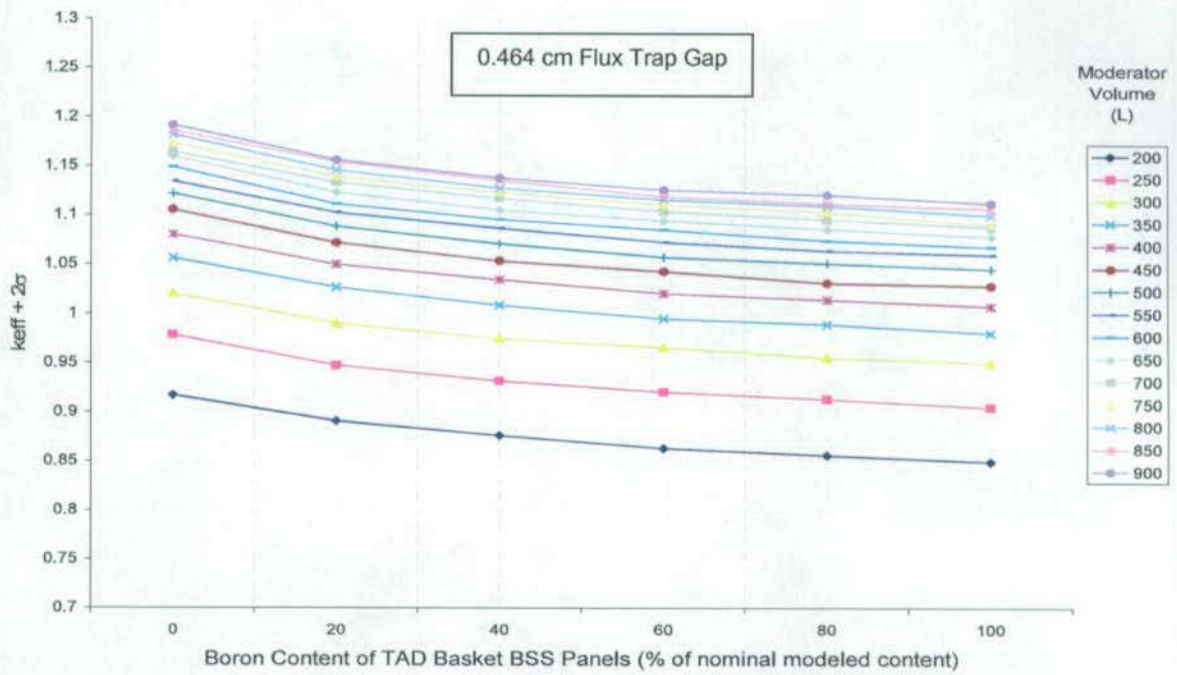

Source: Original

Figure 52. Variation of $k_{eff} + 2\sigma$ for Single Partially Damaged (0.464 Cm Flux Trap Gap) and Partially Flooded PWR TAD Canister (with 30cm Thick Steel Reflector) Containing Intact Representative CSNF with Maximum Fuel Deformation (I.E. 100% Birdcaging)

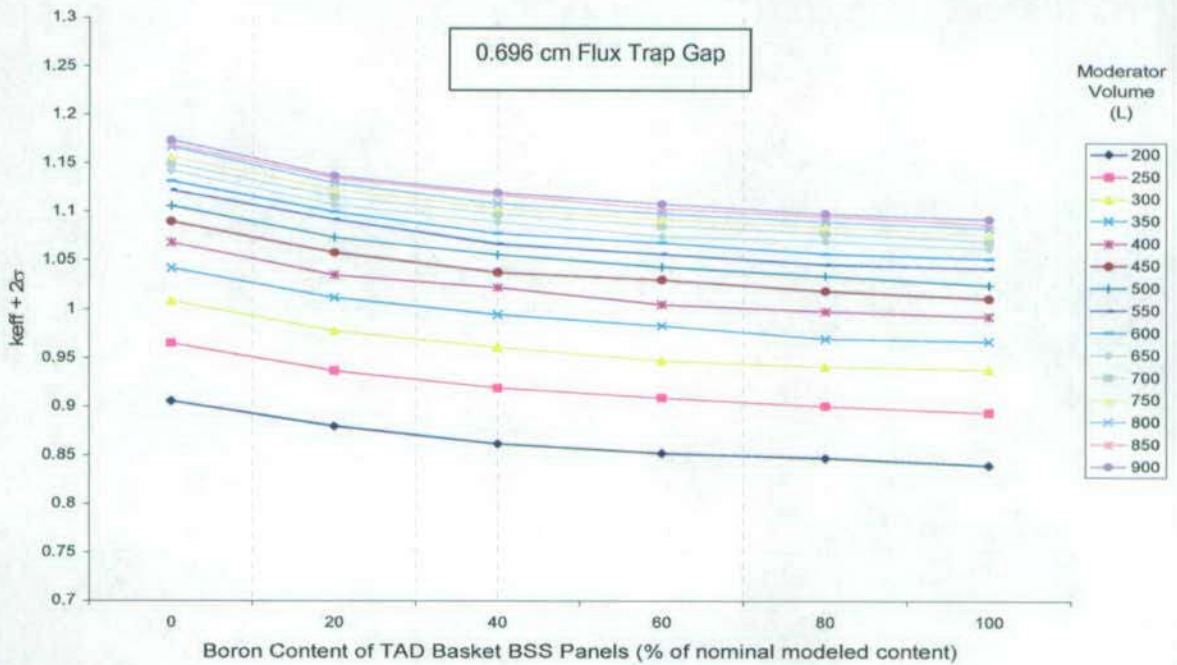

Source: Original

Figure 53. Variation of $k_{eff} + 2\sigma$ for Single Partially Damaged (0.696 Cm Flux Trap Gap) and Partially Flooded PWR TAD Canister (with 30cm Thick Steel Reflector) Containing Intact Representative CSNF with Maximum Fuel Deformation (I.E. 100% Birdcaging)

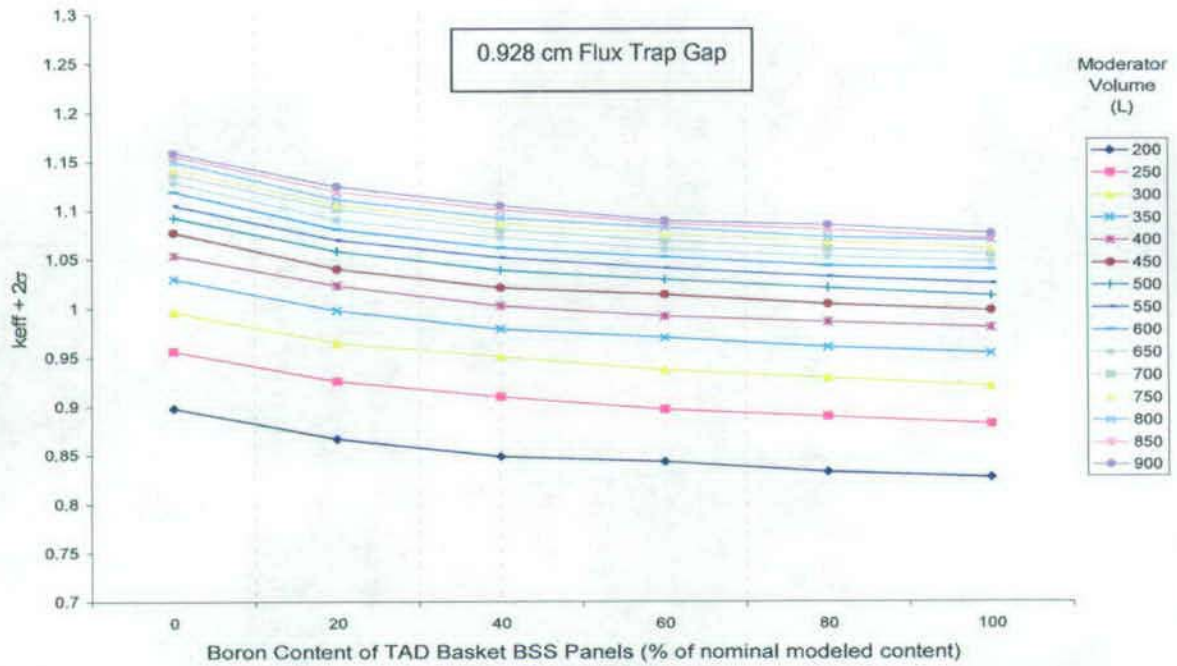

Source: Original

Figure 54. Variation of $k_{eff} + 2\sigma$ for Single Partially Damaged (0.928 Cm Flux Trap Gap) and Partially Flooded PWR TAD Canister (with 30cm Thick Steel Reflector) Containing Intact Representative CSNF with Maximum Fuel Deformation (I.E. 100% Birdcaging)

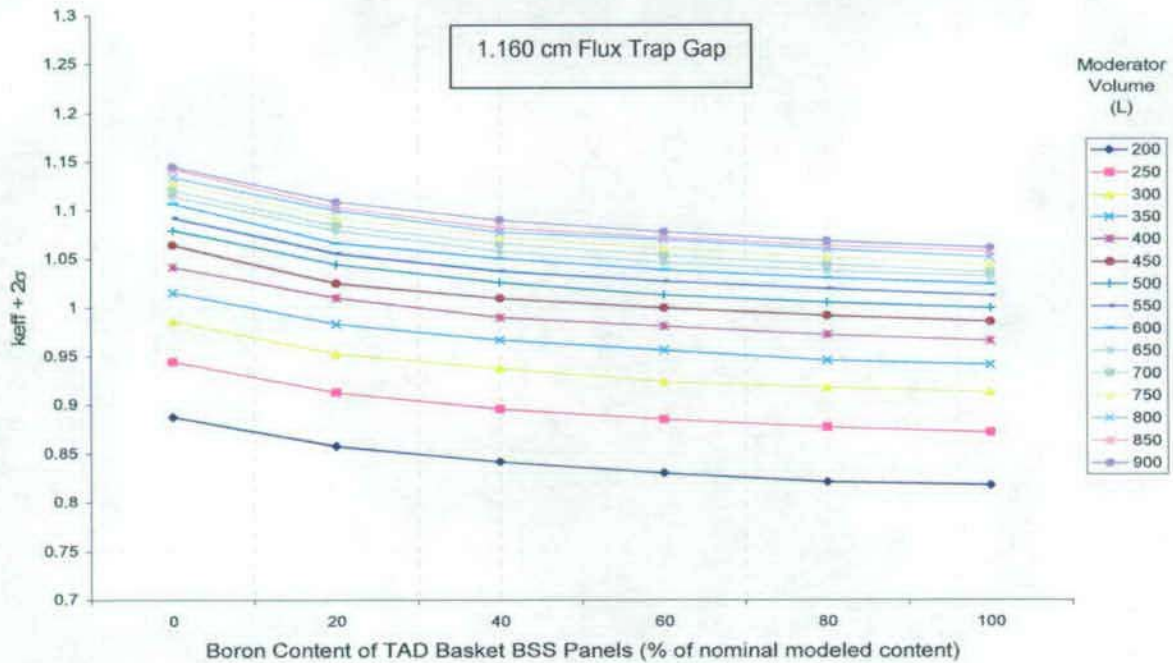

Source: Original

Figure 55. Variation of $k_{eff} + 2\sigma$ for Single Partially Damaged (1.160 Cm Flux Trap Gap) and Partially Flooded PWR TAD Canister (with 30cm Thick Steel Reflector) Containing Intact Representative CSNF with Maximum Fuel Deformation (I.E. 100% Birdcaging)

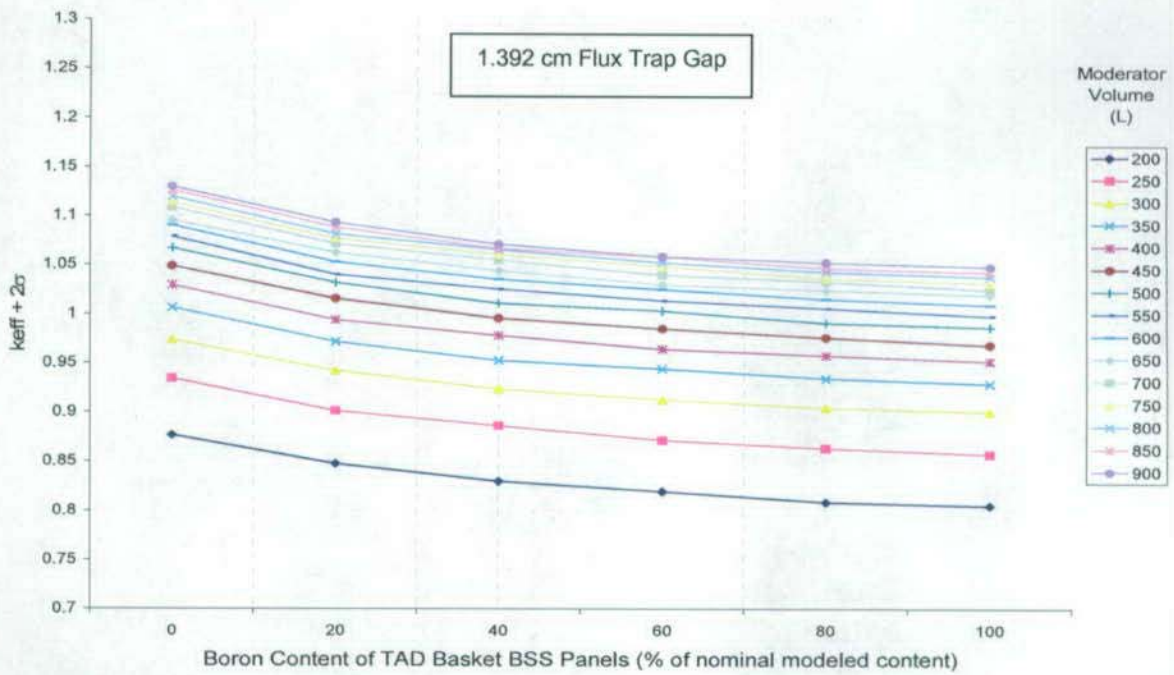

Source: Original

Figure 56. Variation of $k_{eff} + 2\sigma$ for Single Partially Damaged (1.392 Cm Flux Trap Gap) and Partially Flooded PWR TAD Canister (with 30cm Thick Steel Reflector) Containing Intact Representative CSNF with Maximum Fuel Deformation (I.E. 100% Birdcaging)

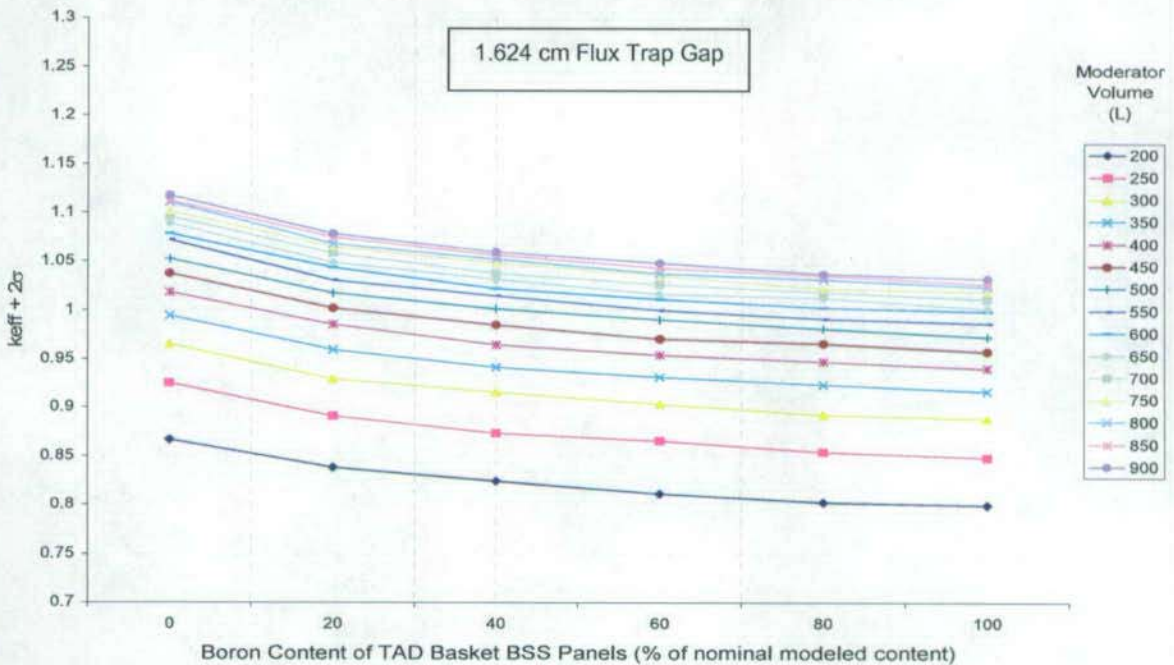

Source: Original

Figure 57. Variation of $k_{eff} + 2\sigma$ for Single Partially Damaged (1.624 Cm Flux Trap Gap) and Partially Flooded PWR TAD Canister (with 30cm Thick Steel Reflector) Containing Intact Representative CSNF with Maximum Fuel Deformation (I.E. 100% Birdcaging)

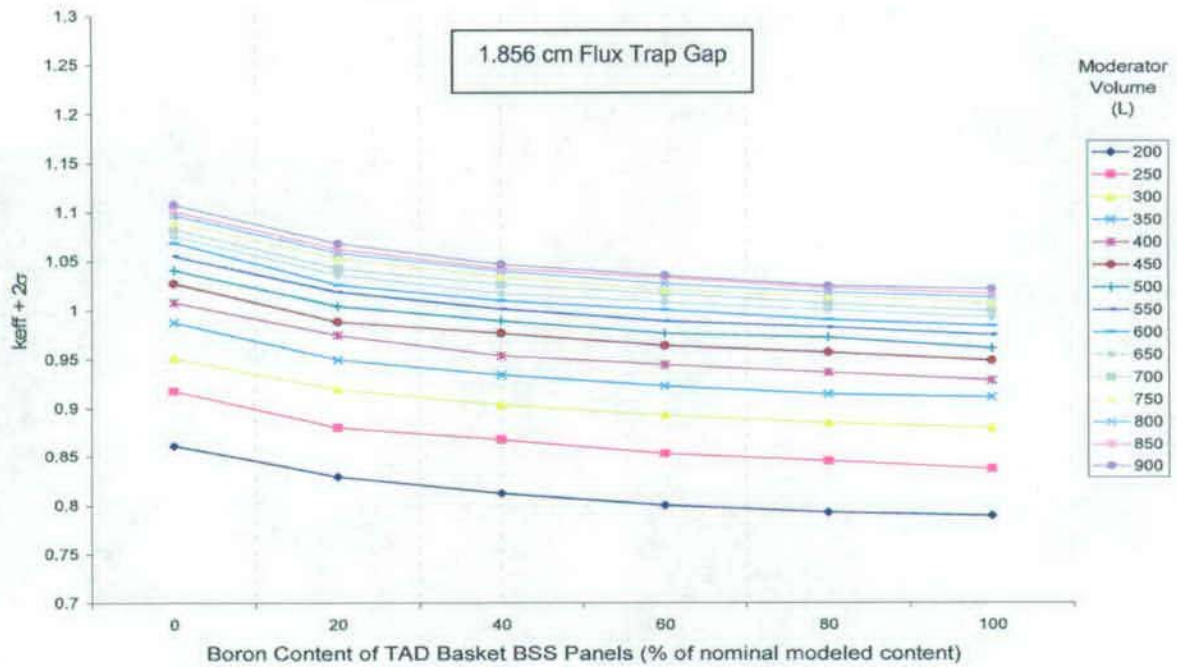

Source: Original

Figure 58. Variation of $k_{eff} + 2\sigma$ for Single Partially Damaged (1.856 Cm Flux Trap Gap) and Partially Flooded PWR TAD Canister (with 30cm Thick Steel Reflector) Containing Intact Representative CSNF with Maximum Fuel Deformation (I.E. 100% Birdcaging)

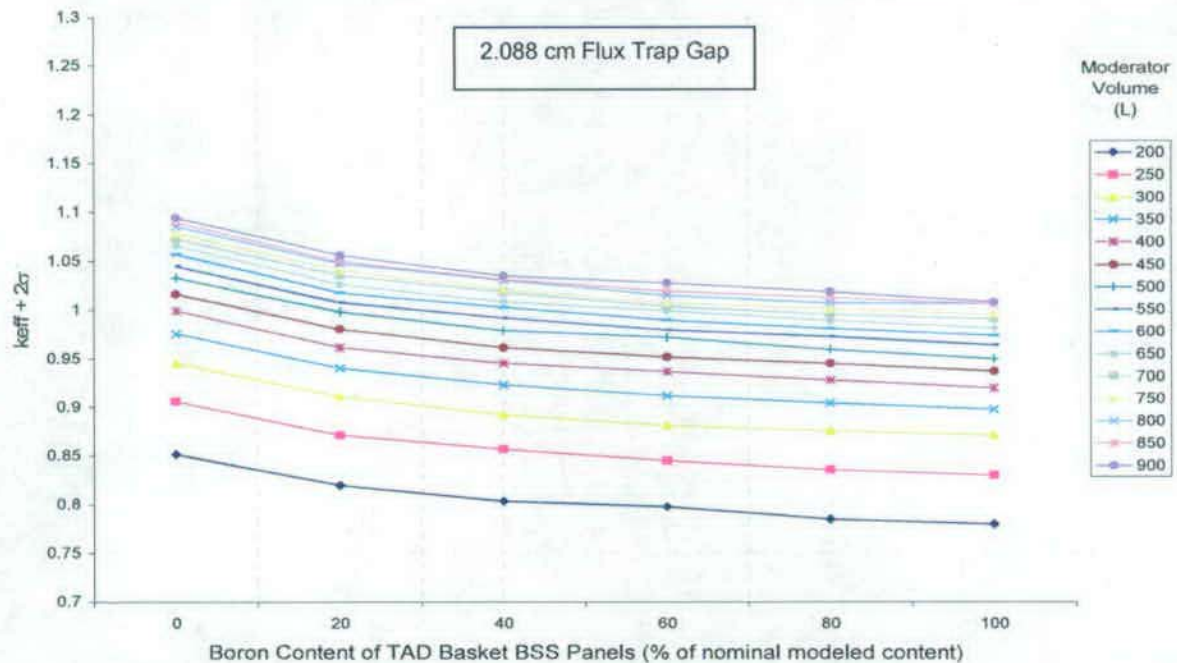

Source: Original

Figure 59. Variation of $k_{eff} + 2\sigma$ for Single Partially Damaged (2.088 Cm Flux Trap Gap) and Partially Flooded PWR TAD Canister (with 30cm Thick Steel Reflector) Containing Intact Representative CSNF with Maximum Fuel Deformation (I.E. 100% Birdcaging)

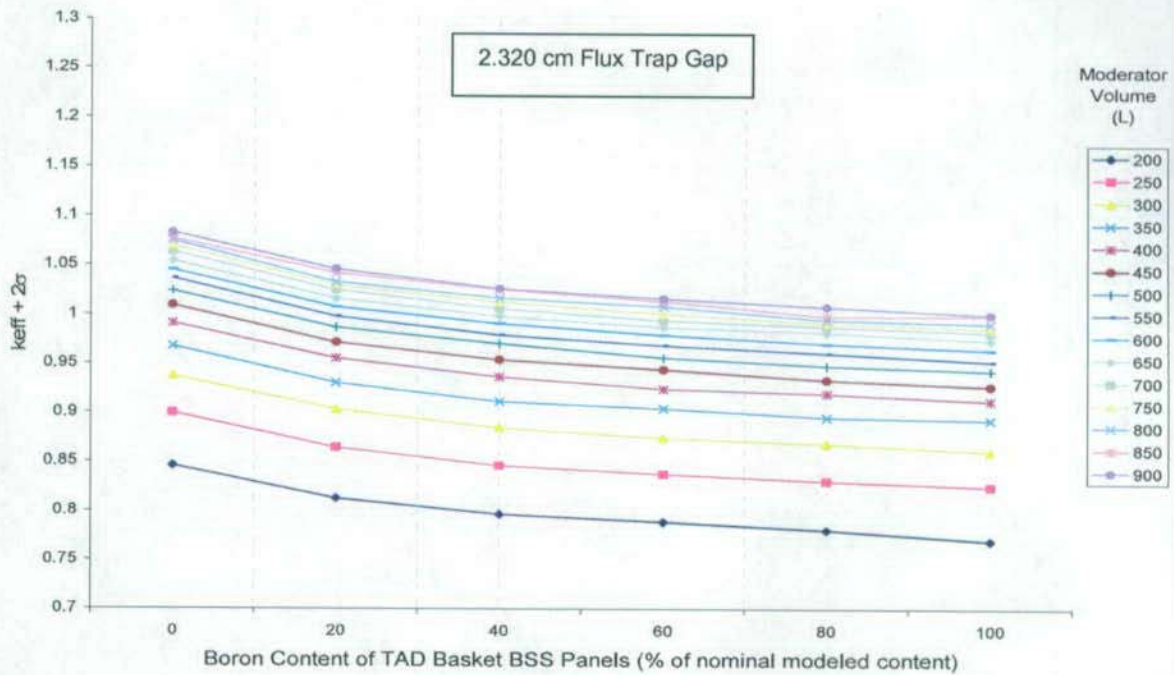

Source: Original

Figure 60. Variation of $k_{eff} + 2\sigma$ for Single Partially Damaged (2.320 Cm Flux Trap Gap) and Partially Flooded PWR TAD Canister (with 30cm Thick Steel Reflector) Containing Intact Representative CSNF with Maximum Fuel Deformation (I.E. 100% Birdcaging)

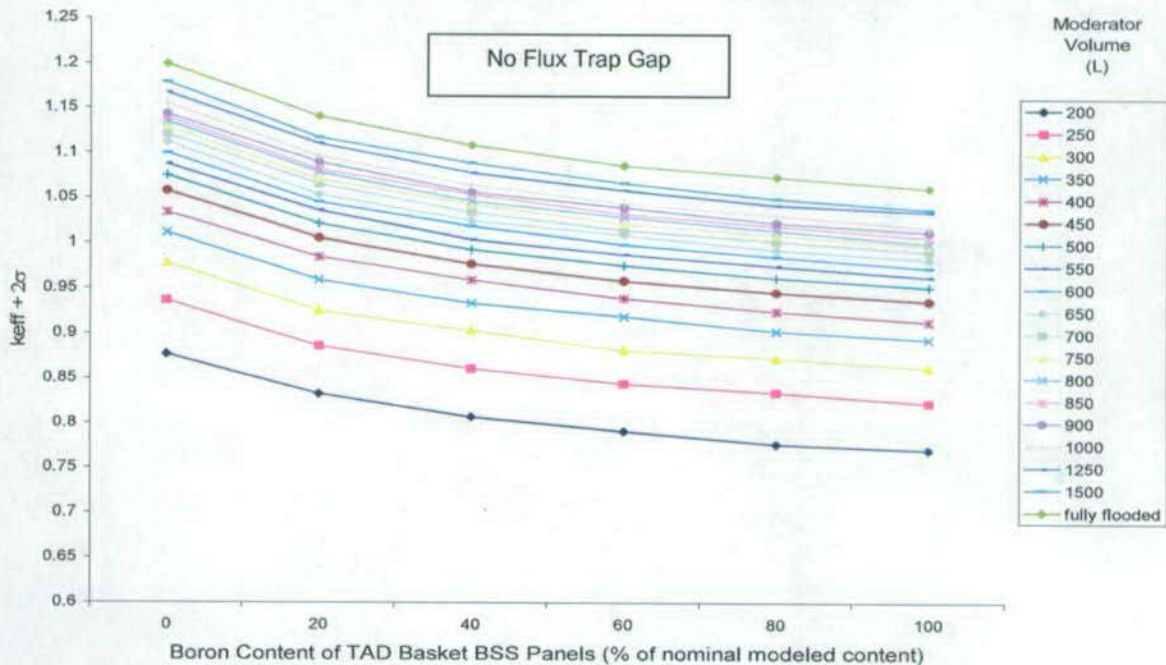

Source: Original

Figure 61. Variation of $k_{eff} + 2\sigma$ for Single Maximum Damaged (No Flux Trap Gap) and Partially Flooded BWR TAD Canister (with 30cm Thick Steel Reflector) Containing Intact Representative CSNF with Maximum Fuel Deformation (I.E. 100% Birdcaging)

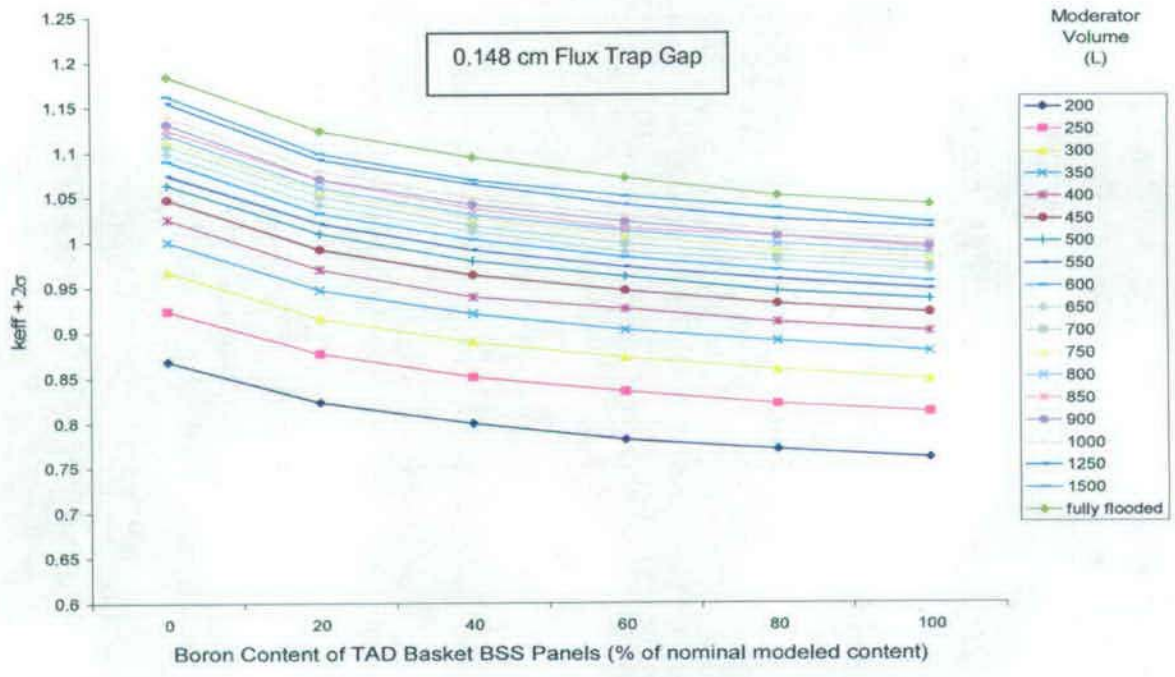

Source: Original

Figure 62. Variation of $k_{eff} + 2\sigma$ for Single Partially Damaged (0.148 Cm Flux Trap Gap) and Partially Flooded BWR TAD Canister (with 30cm Thick Steel Reflector) Containing Intact Representative CSNF with Maximum Fuel Deformation (I.E. 100% Birdcaging)

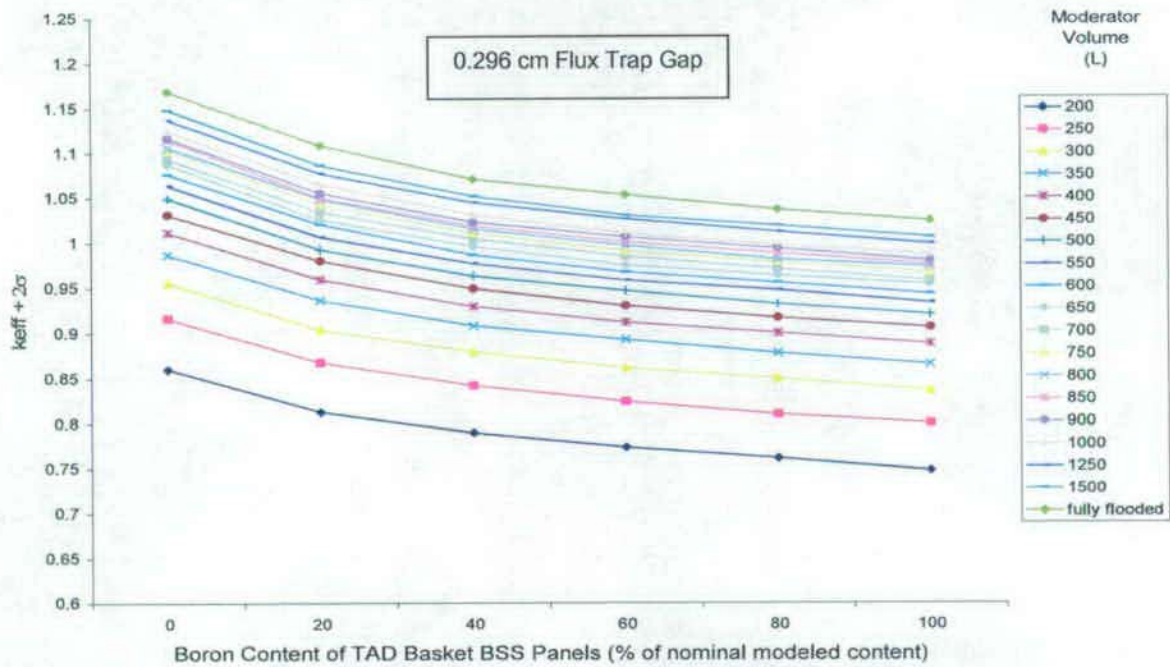

Source: Original

Figure 63. Variation of $k_{eff} + 2\sigma$ for Single Partially Damaged (0.296 Cm Flux Trap Gap) and Partially Flooded BWR TAD Canister (with 30cm Thick Steel Reflector) Containing Intact Representative CSNF with Maximum Fuel Deformation (I.E. 100% Birdcaging)

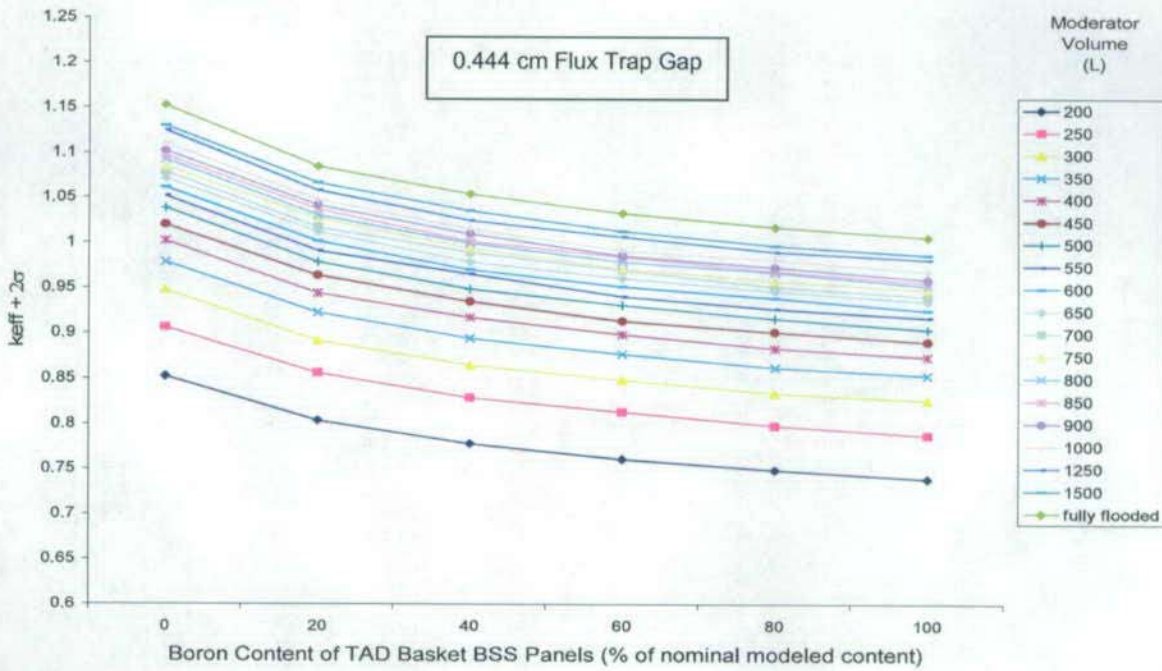

Source: Original

Figure 64. Variation of $k_{eff} + 2\sigma$ for Single Partially Damaged (0.444 Cm Flux Trap Gap) and Partially Flooded BWR TAD Canister (with 30cm Thick Steel Reflector) Containing Intact Representative CSNF with Maximum Fuel Deformation (I.E. 100% Birdcaging)

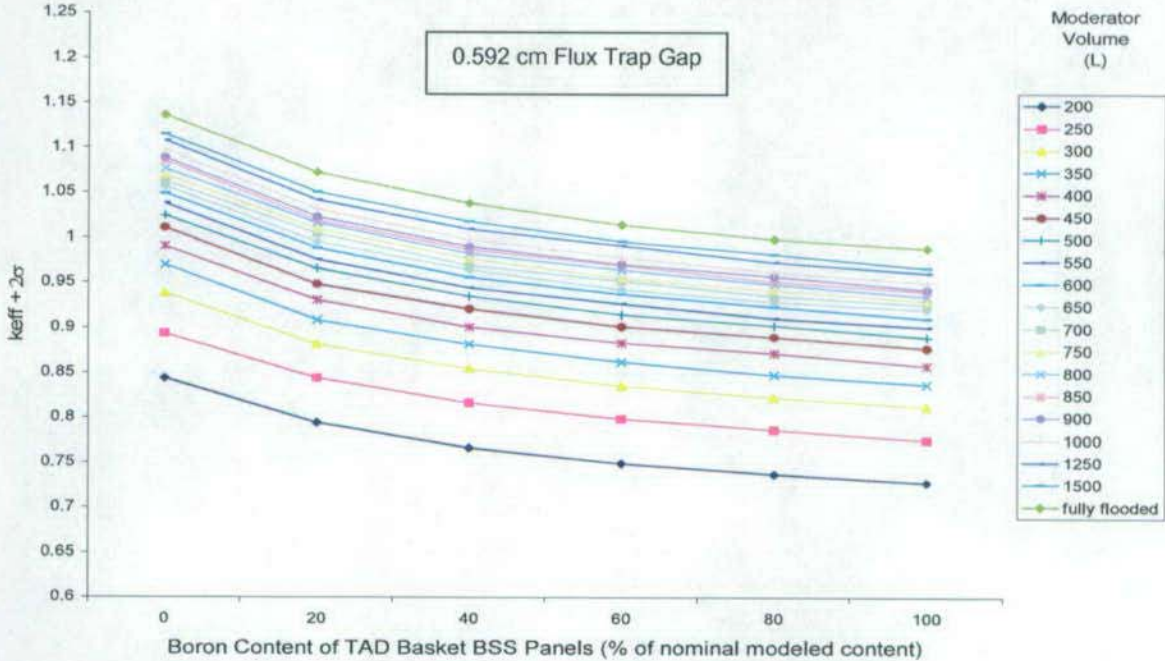

Source: Original

Figure 65. Variation of $k_{eff} + 2\sigma$ for Single Partially Damaged (0.592 Cm Flux Trap Gap) and Partially Flooded BWR TAD Canister (with 30cm Thick Steel Reflector) Containing Intact Representative CSNF with Maximum Fuel Deformation (I.E. 100% Birdcaging)

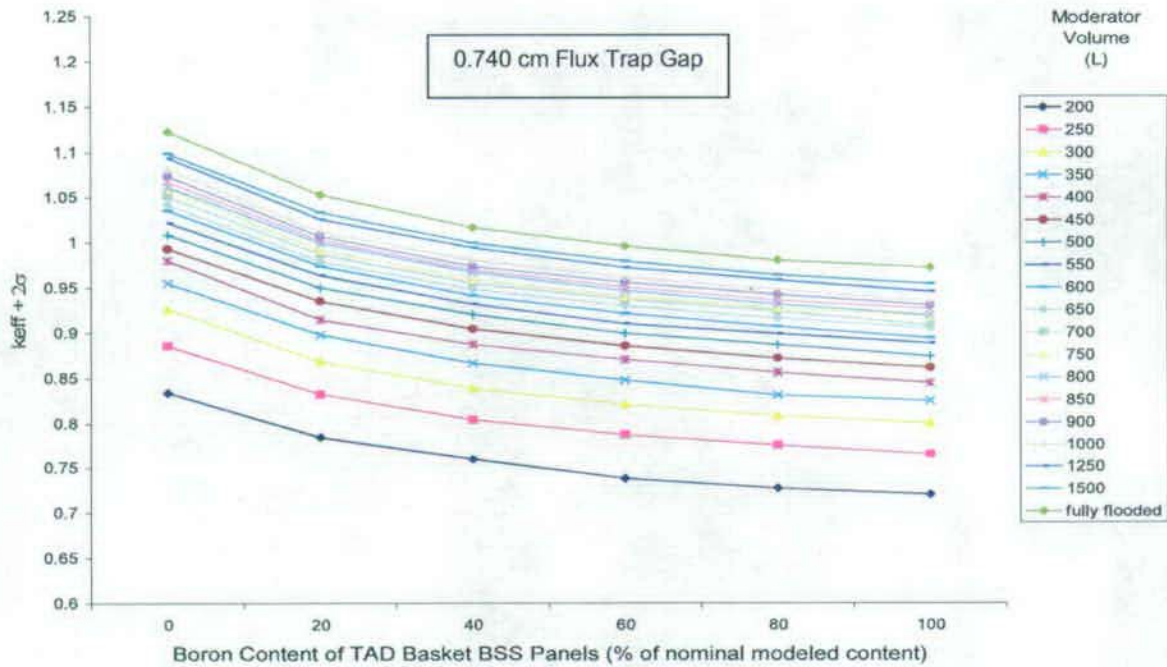

Source: Original

Figure 66. Variation of $k_{eff} + 2\sigma$ for Single Partially Damaged (0.740 Cm Flux Trap Gap) and Partially Flooded BWR TAD Canister (with 30cm Thick Steel Reflector) Containing Intact Representative CSNF with Maximum Fuel Deformation (I.E. 100% Birdcaging)

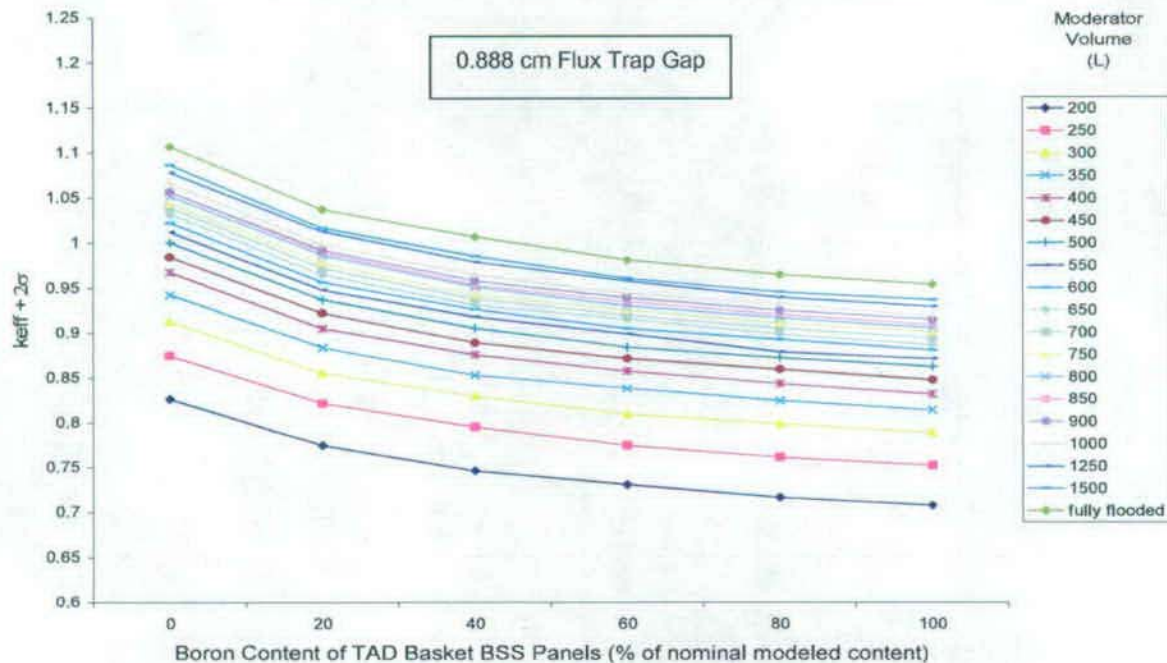

Source: Original

Figure 67. Variation of $k_{eff} + 2\sigma$ for Single Partially Damaged (0.888 Cm Flux Trap Gap) and Partially Flooded BWR TAD Canister (with 30cm Thick Steel Reflector) Containing Intact Representative CSNF with Maximum Fuel Deformation (I.E. 100% Birdcaging)

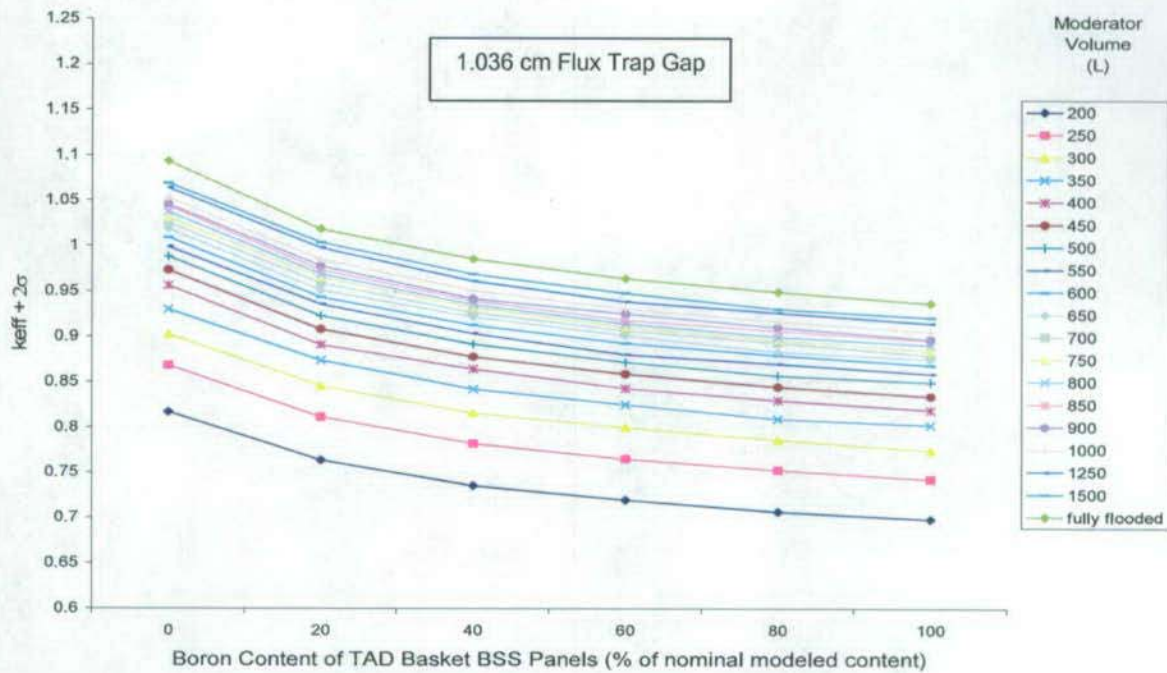

Source: Original

Figure 68. Variation of $k_{eff} + 2\sigma$ for Single Partially Damaged (1.036 Cm Flux Trap Gap) and Partially Flooded BWR TAD Canister (with 30cm Thick Steel Reflector) Containing Intact Representative CSNF with Maximum Fuel Deformation (I.E. 100% Birdcaging)

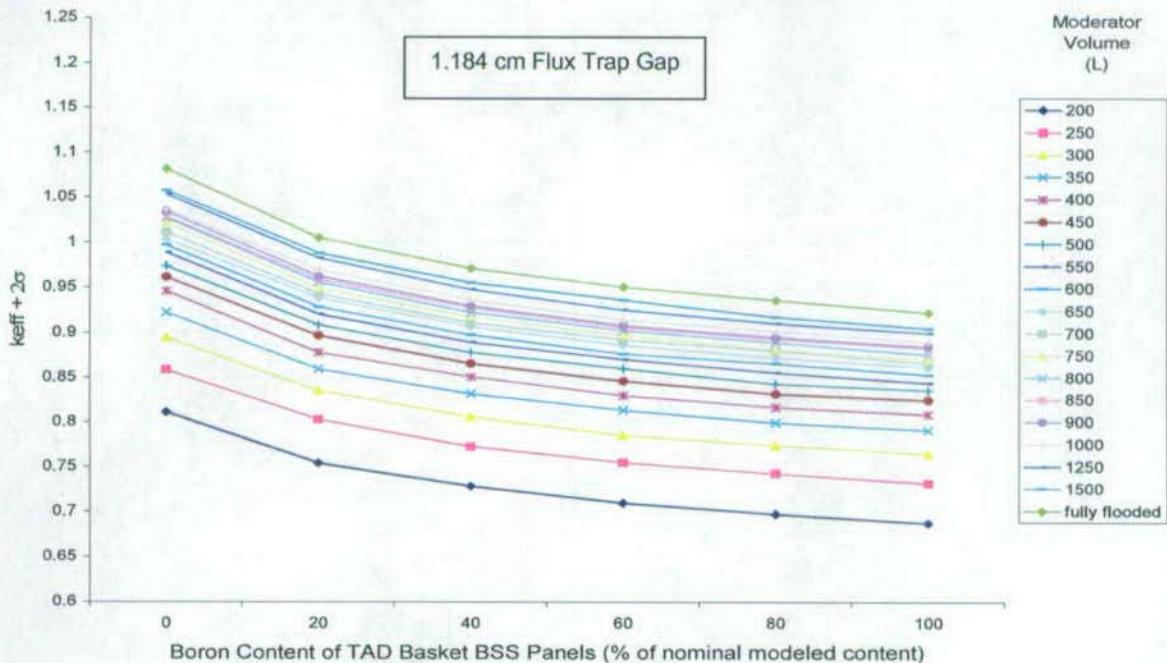

Source: Original

Figure 69. Variation of $k_{eff} + 2\sigma$ for Single Partially Damaged (1.184 Cm Flux Trap Gap) and Partially Flooded BWR TAD Canister (with 30cm Thick Steel Reflector) Containing Intact Representative CSNF with Maximum Fuel Deformation (I.E. 100% Birdcaging)

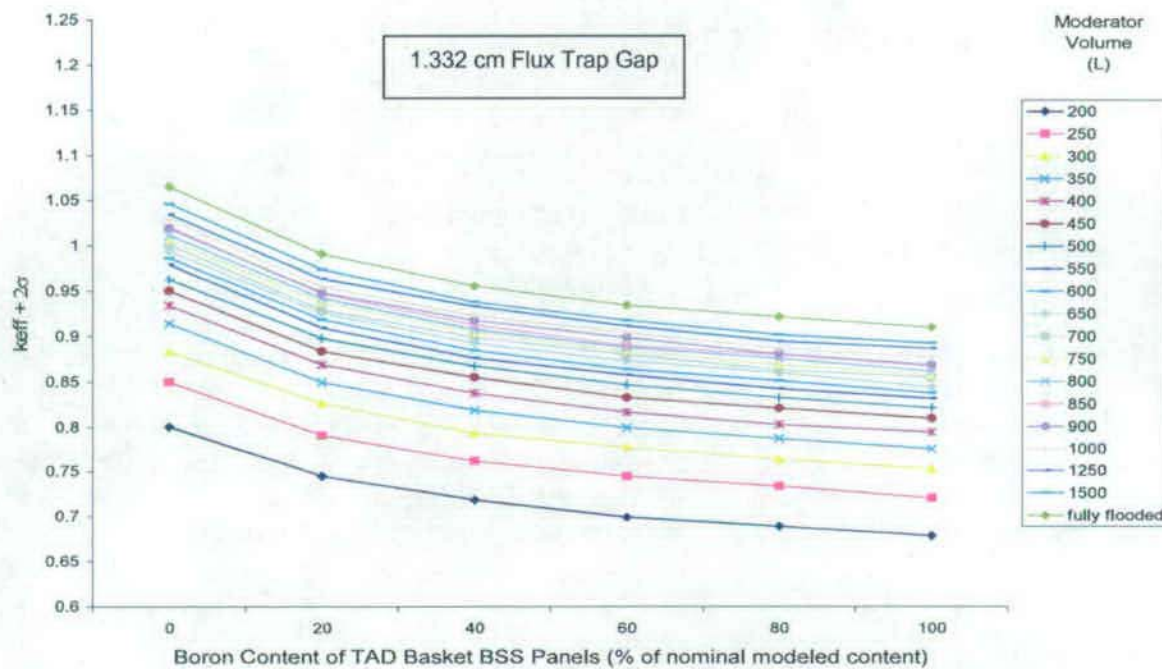

Source: Original

Figure 70. Variation of $k_{eff} + 2\sigma$ for Single Partially Damaged (1.332 Cm Flux Trap Gap) and Partially Flooded BWR TAD Canister (with 30cm Thick Steel Reflector) Containing Intact Representative CSNF with Maximum Fuel Deformation (I.E. 100% Birdcaging)

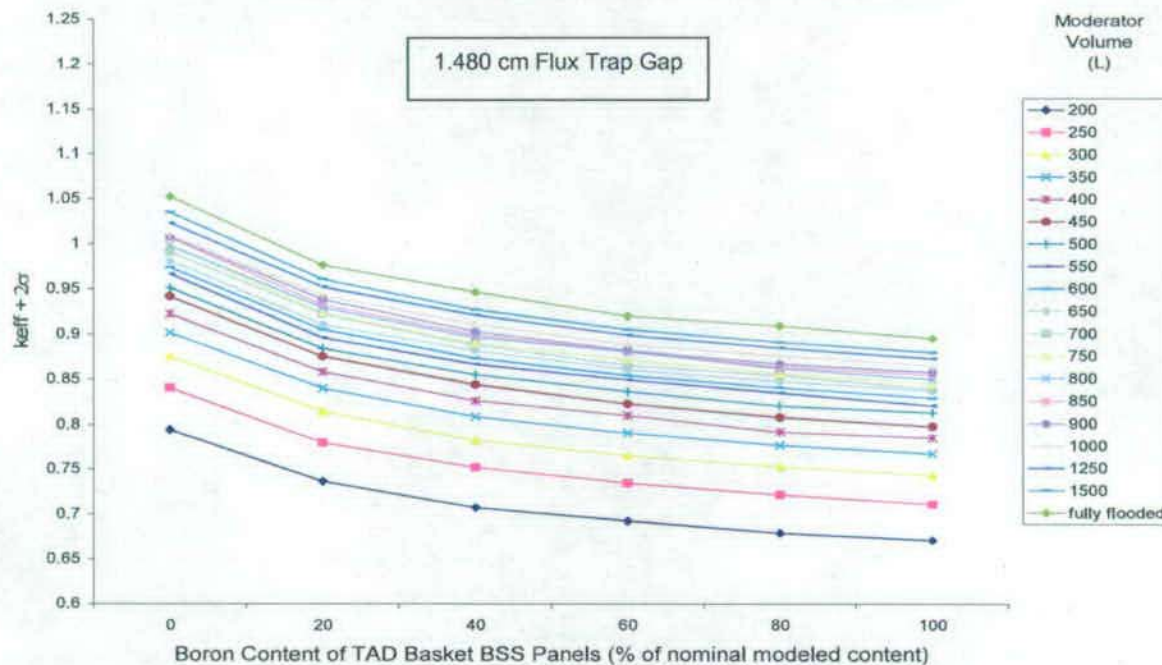

Source: Original

Figure 71. Variation of $k_{eff} + 2\sigma$ for Single Partially Damaged (1.480 Cm Flux Trap Gap) and Partially Flooded BWR TAD Canister (with 30cm Thick Steel Reflector) Containing Intact Representative CSNF with Maximum Fuel Deformation (I.E. 100% Birdcaging)

ATTACHMENT III: POTENTIAL OFF-NORMAL SCENARIO 3 RESULTS

Potential Off-Normal Scenario 3 considers:

- Progressive canister basket deformation (i.e. flux trap gap collapse),
- Progressive fuel assembly deformation (i.e. birdcaging),
- Progressive fuel release (i.e. fuel break-up), and
- Progressive flooding of the TAD canister with water.

The results of the potential off-normal scenario 3 calculations are presented in Figure 72 through Figure 77 of this attachment for the 1% fuel release fraction scenario, Figure 78 through Figure 83 of this attachment for the 3% fuel release fraction scenario, and Figure 84 through Figure 89 of this attachment for the 5% fuel release fraction scenario. An interpolation of the presented results, to establish the maximum safe moderator volume as a function of the basket/fuel assembly damage condition and fuel release fraction considered, is performed in the body of this document (Figure 34).

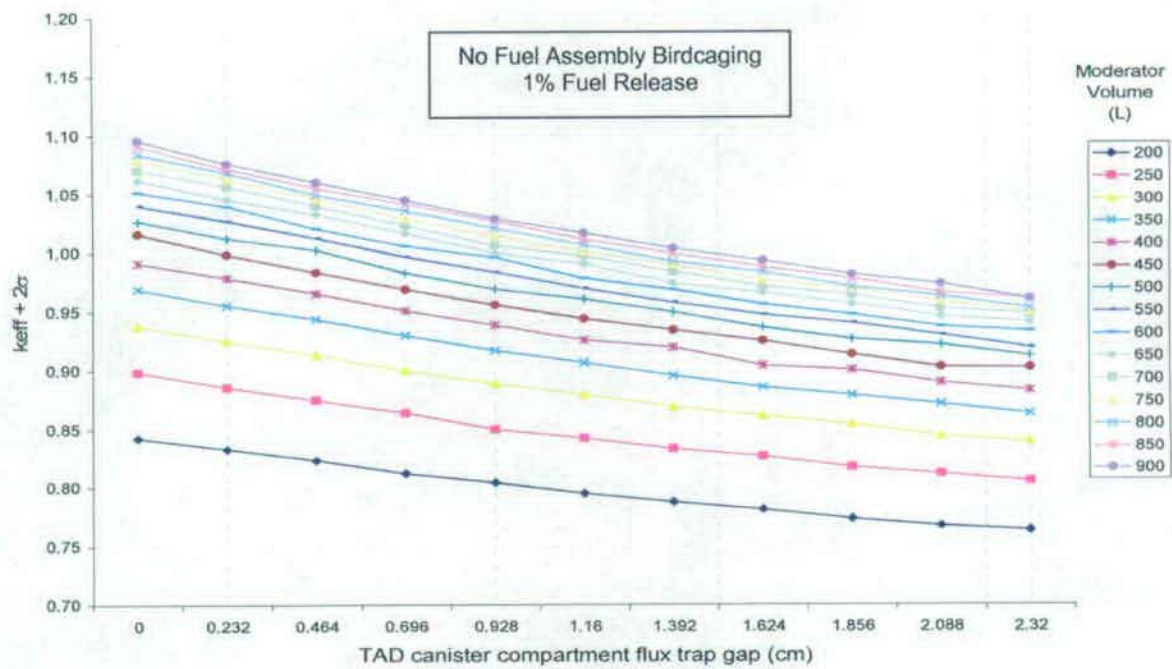

Source: Original

Figure 72. Variation of $k_{eff} + 2\sigma$ for Single Damaged, Partially Flooded PWR TAD Canister (with 30cm Thick Steel Reflector) Containing Representative CSNF with No Fuel Deformation (0% Birdcaging) and 1% Fuel Release

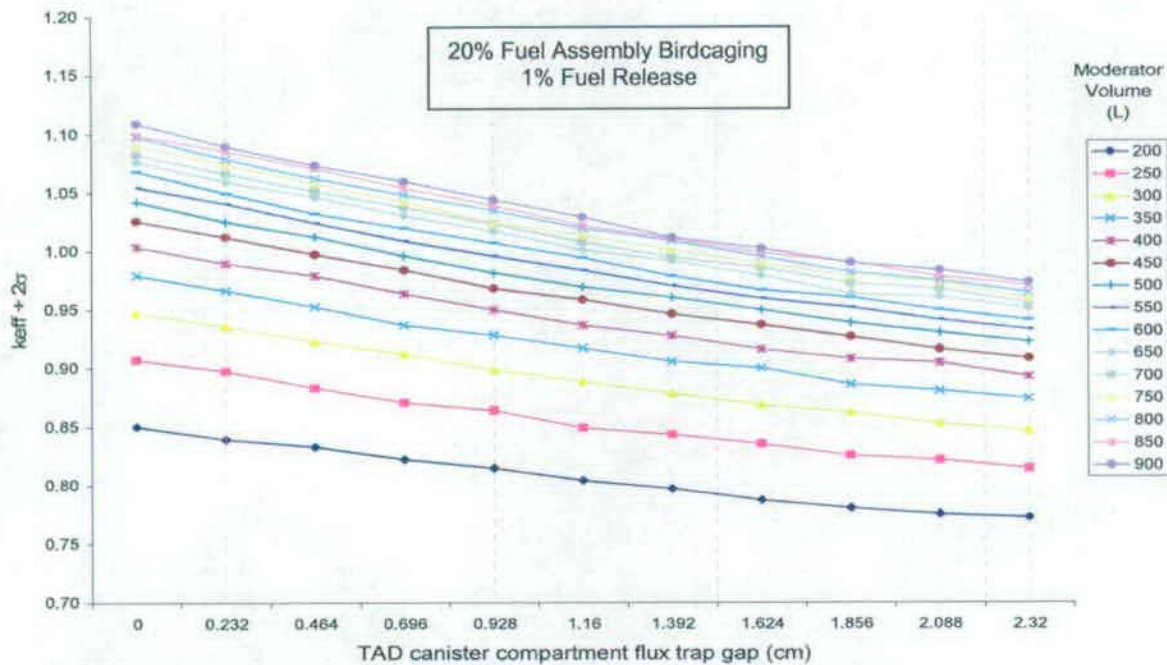

Source: Original

Figure 73. Variation of $k_{eff} + 2\sigma$ for Single Damaged, Partially Flooded PWR TAD Canister (with 30cm Thick Steel Reflector) Containing Representative CSNF with Partial Fuel Deformation (20% Birdcaging) and 1% Fuel Release

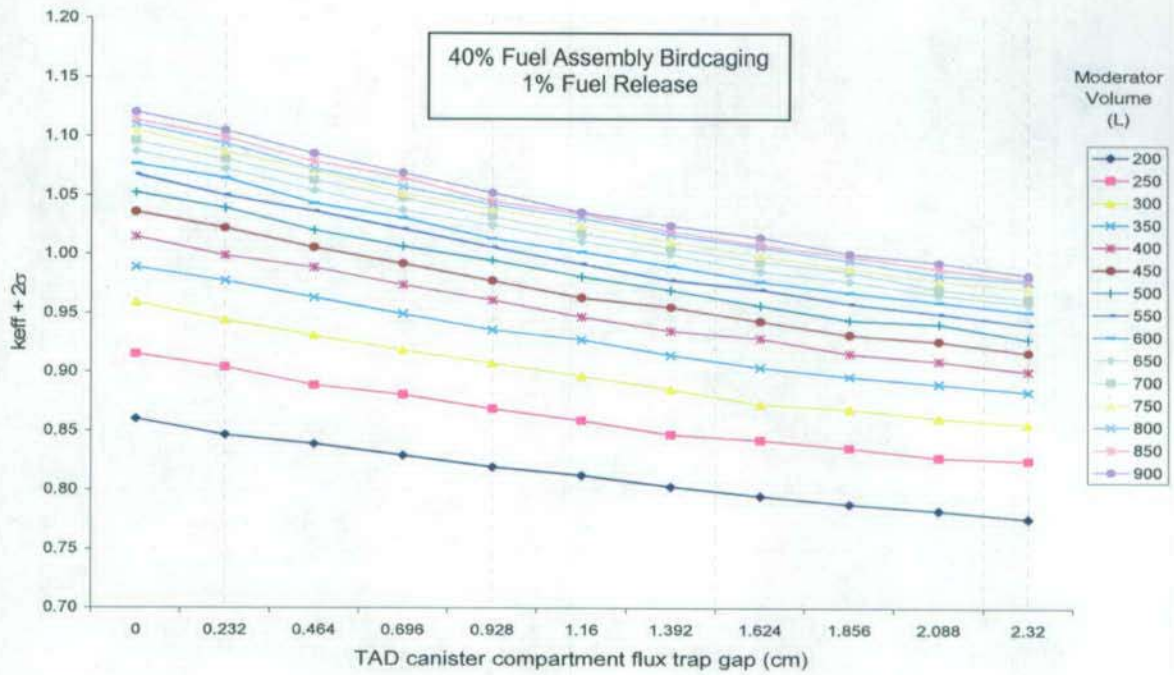

Source: Original

Figure 74. Variation of $k_{eff} + 2\sigma$ for Single Damaged, Partially Flooded PWR TAD Canister (with 30cm Thick Steel Reflector) Containing Representative CSNF with Partial Fuel Deformation (40% Birdcaging) and 1% Fuel Release

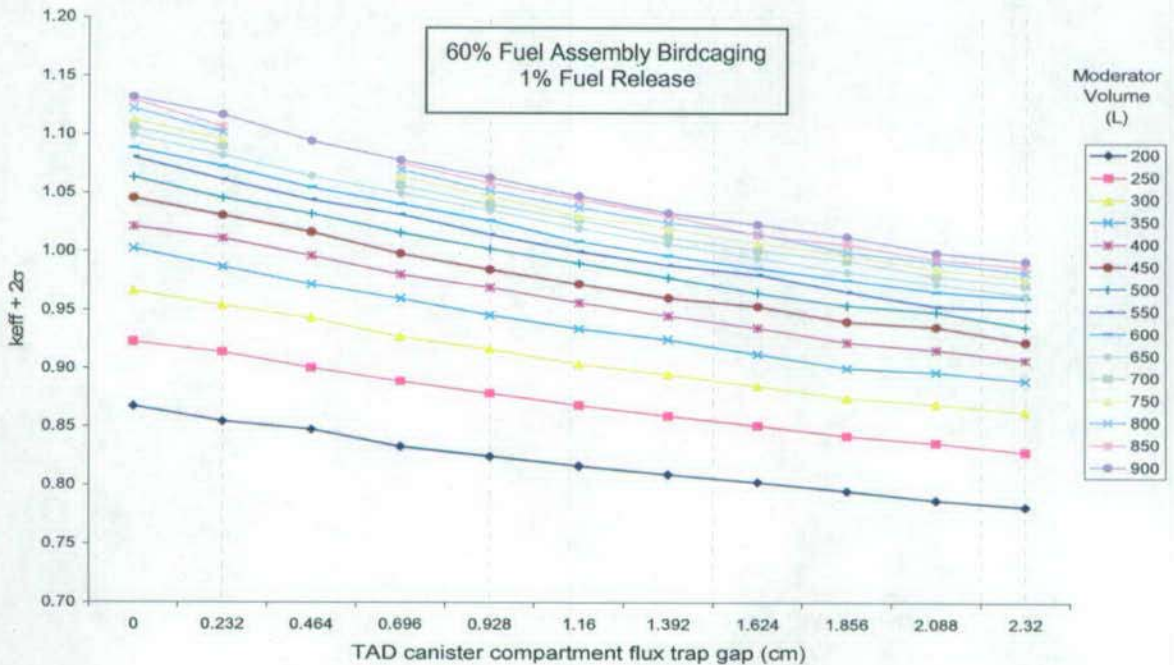

Source: Original

Figure 75. Variation of $k_{eff} + 2\sigma$ for Single Damaged, Partially Flooded PWR TAD Canister (with 30cm Thick Steel Reflector) Containing Representative CSNF with Partial Fuel Deformation (60% Birdcaging) and 1% Fuel Release

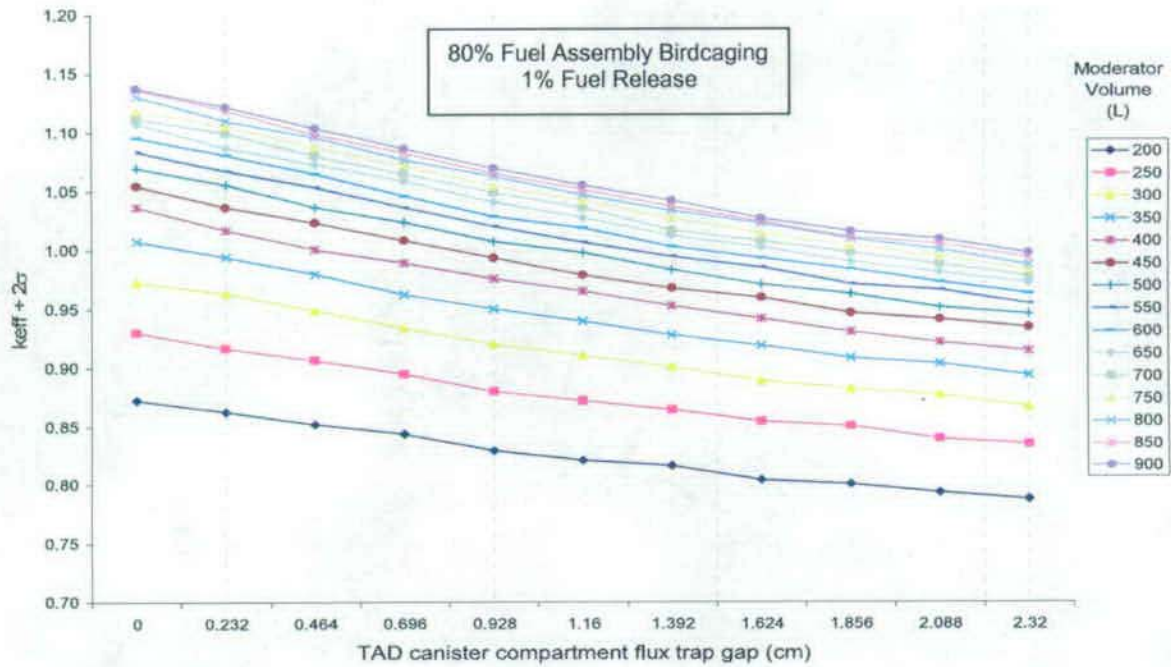

Source: Original

Figure 76. Variation of $k_{eff} + 2\sigma$ for Single Damaged, Partially Flooded PWR TAD Canister (with 30cm Thick Steel Reflector) Containing Representative CSNF with Partial Fuel Deformation (80% Birdcaging) and 1% Fuel Release

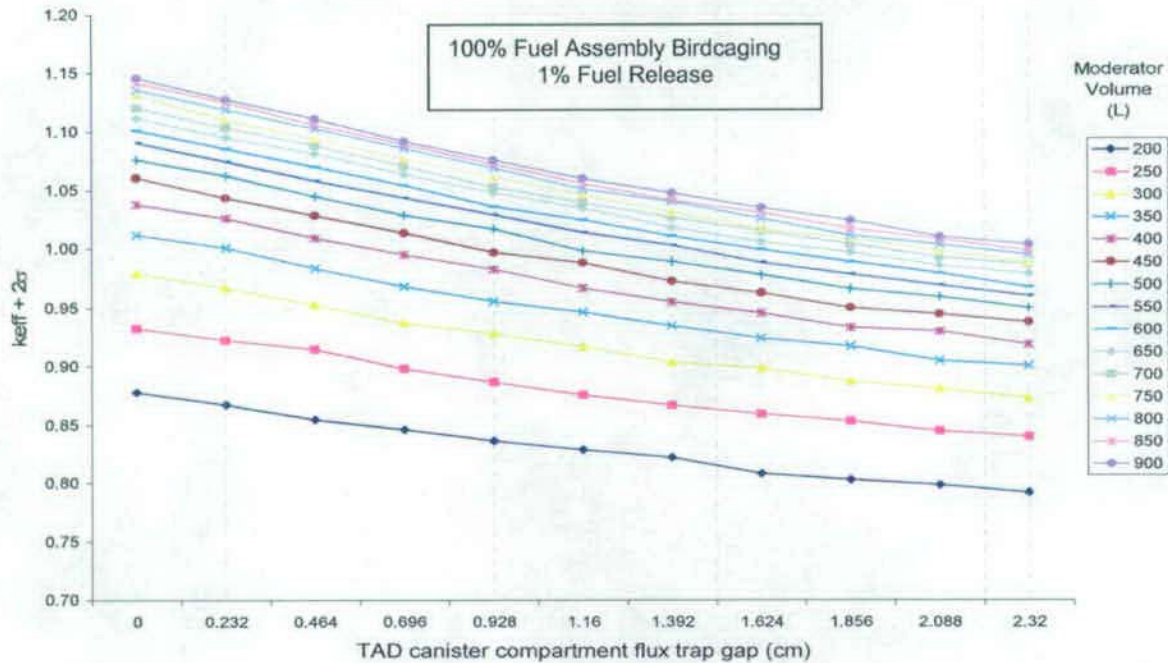

Source: Original

Figure 77. Variation of $k_{eff} + 2\sigma$ for Single Damaged, Partially Flooded PWR TAD Canister (with 30cm Thick Steel Reflector) Containing Representative CSNF with Maximum Fuel Deformation (100% Birdcaging) and 1% Fuel Release

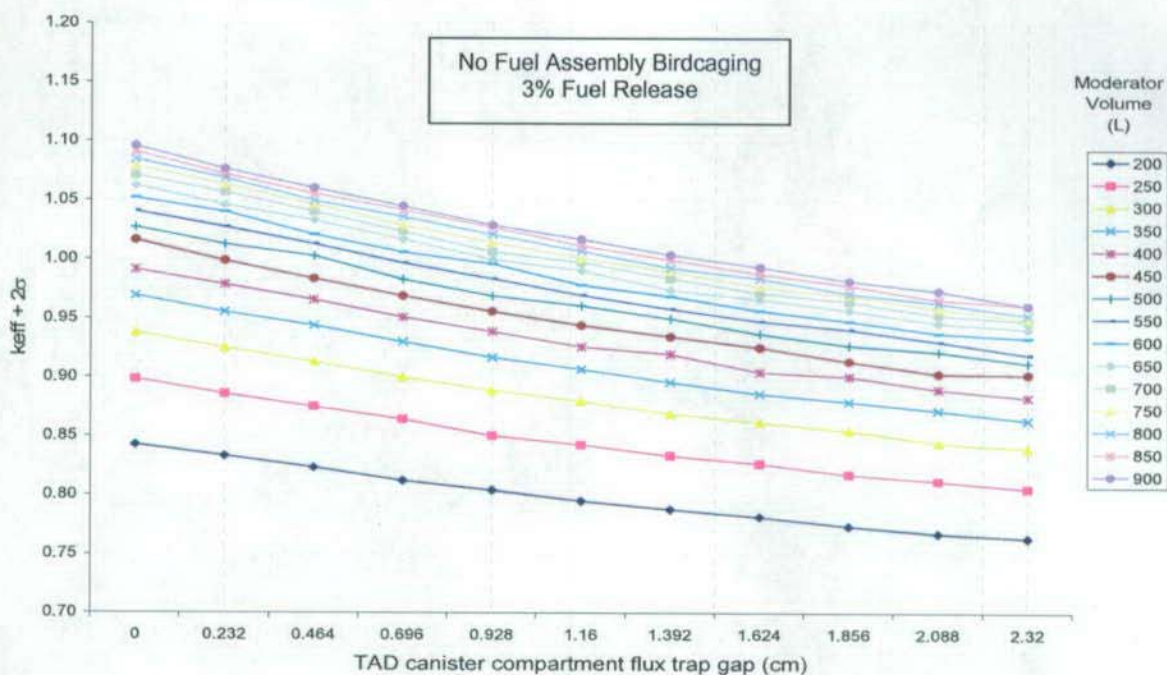

Source: Original

Figure 78. Variation of $k_{eff} + 2\sigma$ for Single Damaged, Partially Flooded PWR TAD Canister (with 30cm Thick Steel Reflector) Containing Representative CSNF with No Fuel Deformation (0% Birdcaging) and 3% Fuel Release

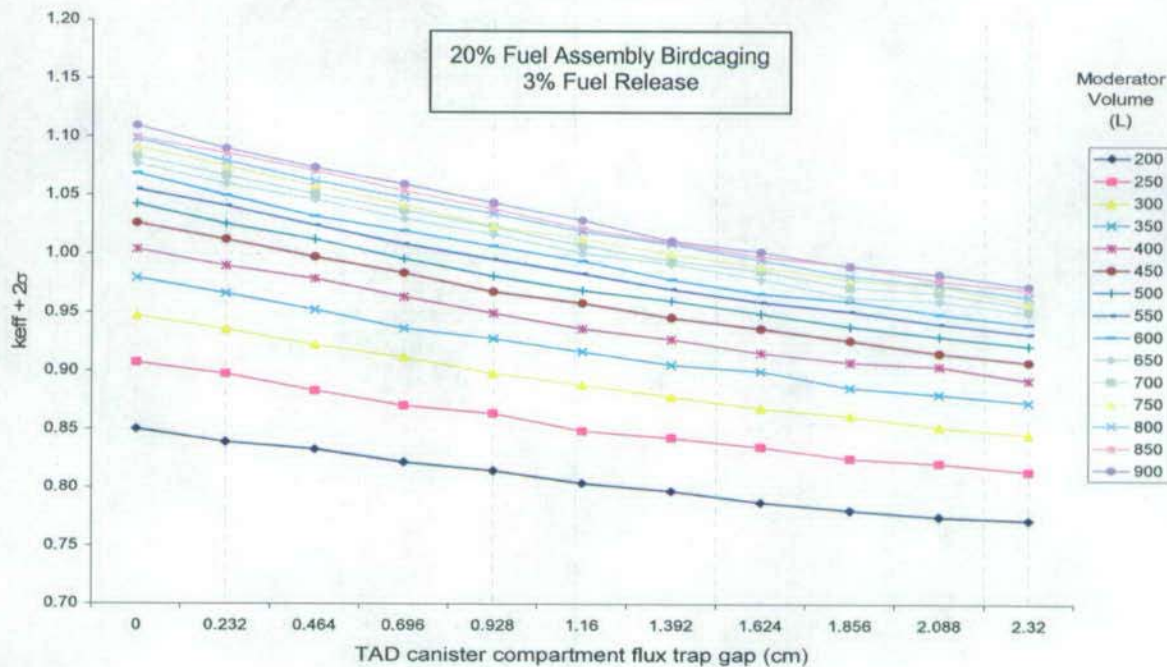

Source: Original

Figure 79. Variation of $k_{eff} + 2\sigma$ for Single Damaged, Partially Flooded PWR TAD Canister (with 30cm Thick Steel Reflector) Containing Representative CSNF with Partial Fuel Deformation (20% Birdcaging) and 3% Fuel Release

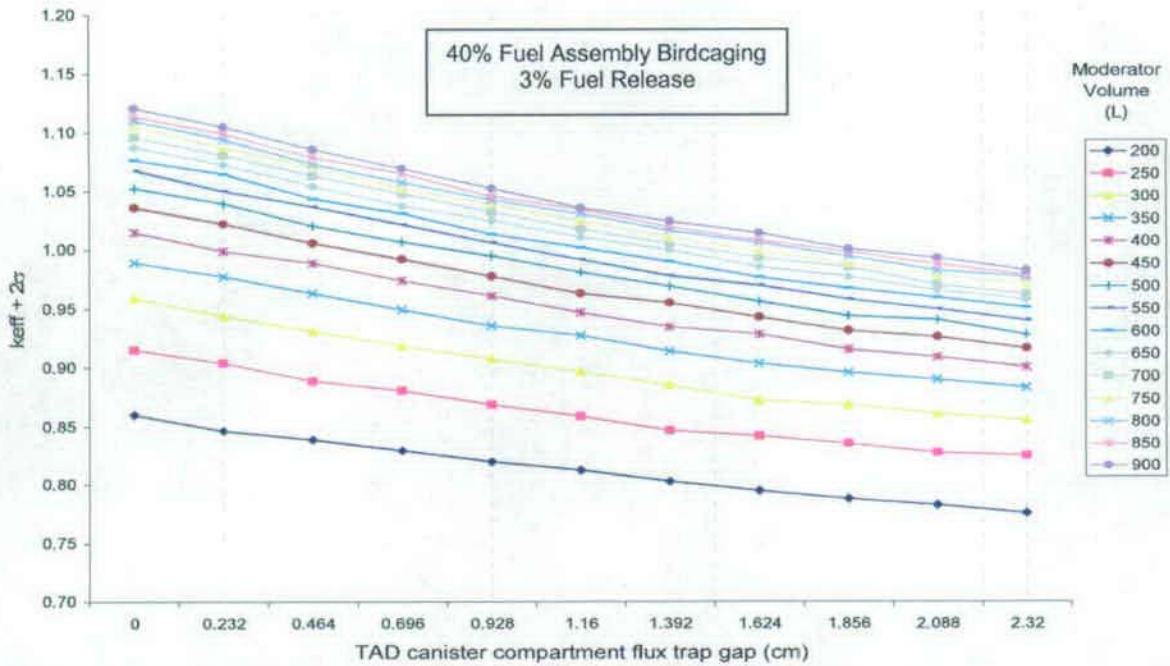

Source: Original

Figure 80. Variation of $k_{eff} + 2\sigma$ for Single Damaged, Partially Flooded PWR TAD Canister (with 30cm Thick Steel Reflector) Containing Representative CSNF with Partial Fuel Deformation (40% Birdcaging) and 3% Fuel Release

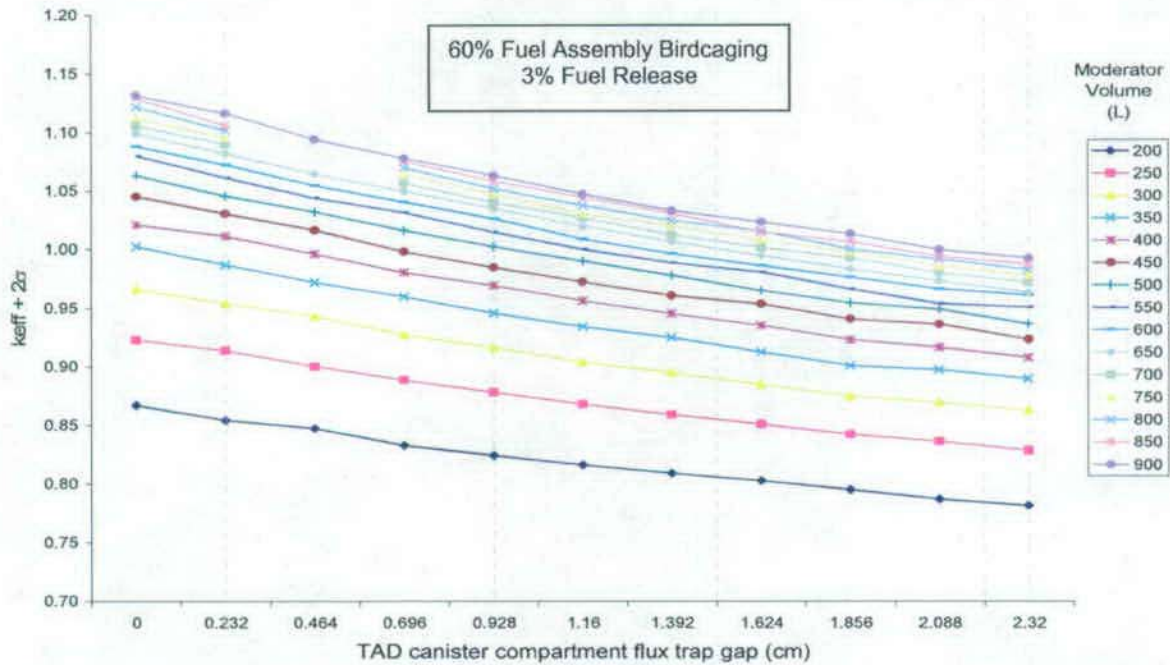

Source: Original

Figure 81. Variation of $k_{eff} + 2\sigma$ for Single Damaged, Partially Flooded PWR TAD Canister (with 30cm Thick Steel Reflector) Containing Representative CSNF with Partial Fuel Deformation (60% Birdcaging) and 3% Fuel Release

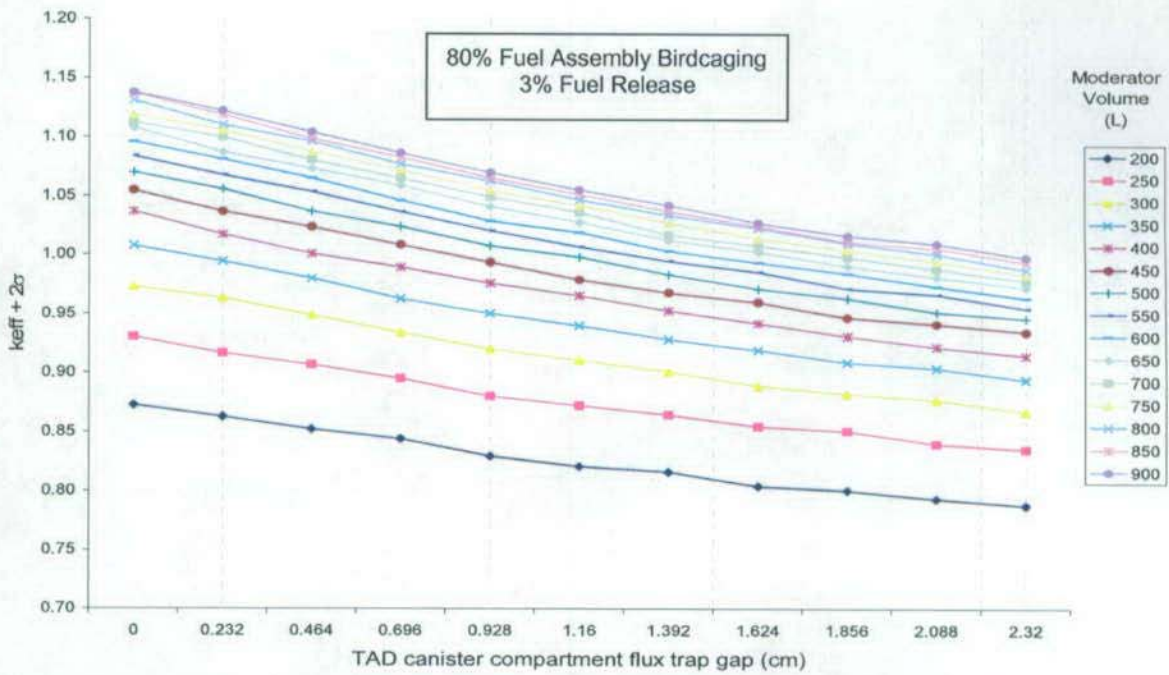

Source: Original

Figure 82. Variation of $k_{eff} + 2\sigma$ for Single Damaged, Partially Flooded PWR TAD Canister (with 30cm Thick Steel Reflector) Containing Representative CSNF with Partial Fuel Deformation (80% Birdcaging) and 3% Fuel Release

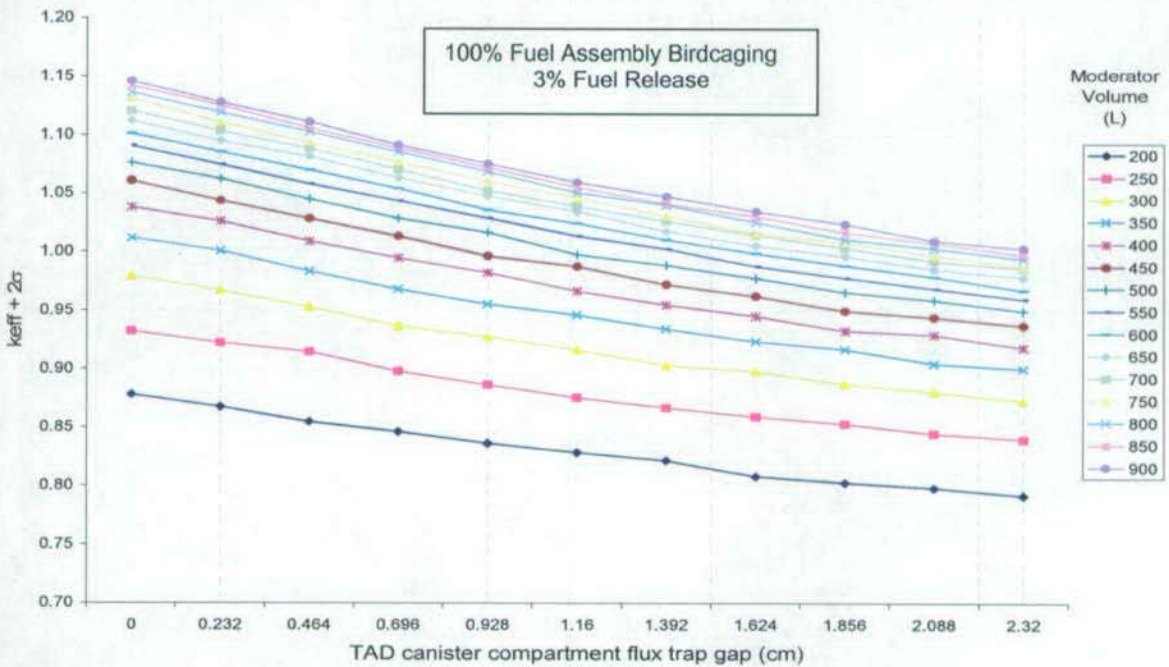

Source: Original

Figure 83. Variation of $k_{eff} + 2\sigma$ for Single Damaged, Partially Flooded PWR TAD Canister (with 30cm Thick Steel Reflector) Containing Representative CSNF with Maximum Fuel Deformation (100% Birdcaging) and 3% Fuel Release

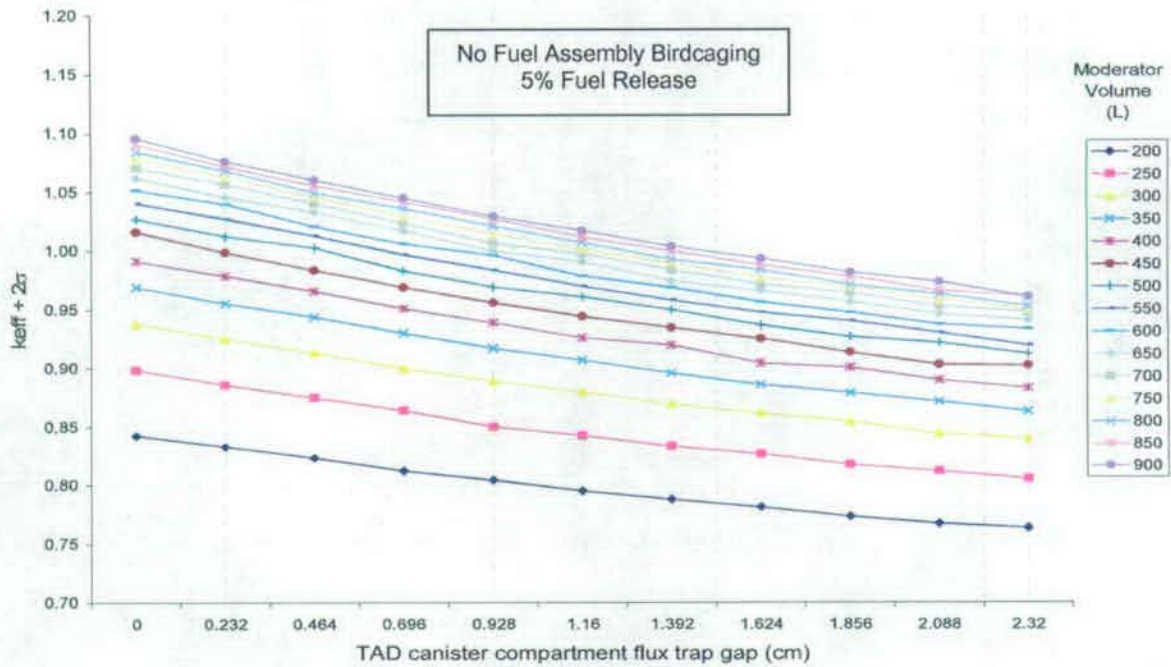

Source: Original

Figure 84. Variation of $k_{eff} + 2\sigma$ for Single Damaged, Partially Flooded PWR TAD Canister (with 30cm Thick Steel Reflector) Containing Representative CSNF with No Fuel Deformation (0% Birdcaging) and 5% Fuel Release

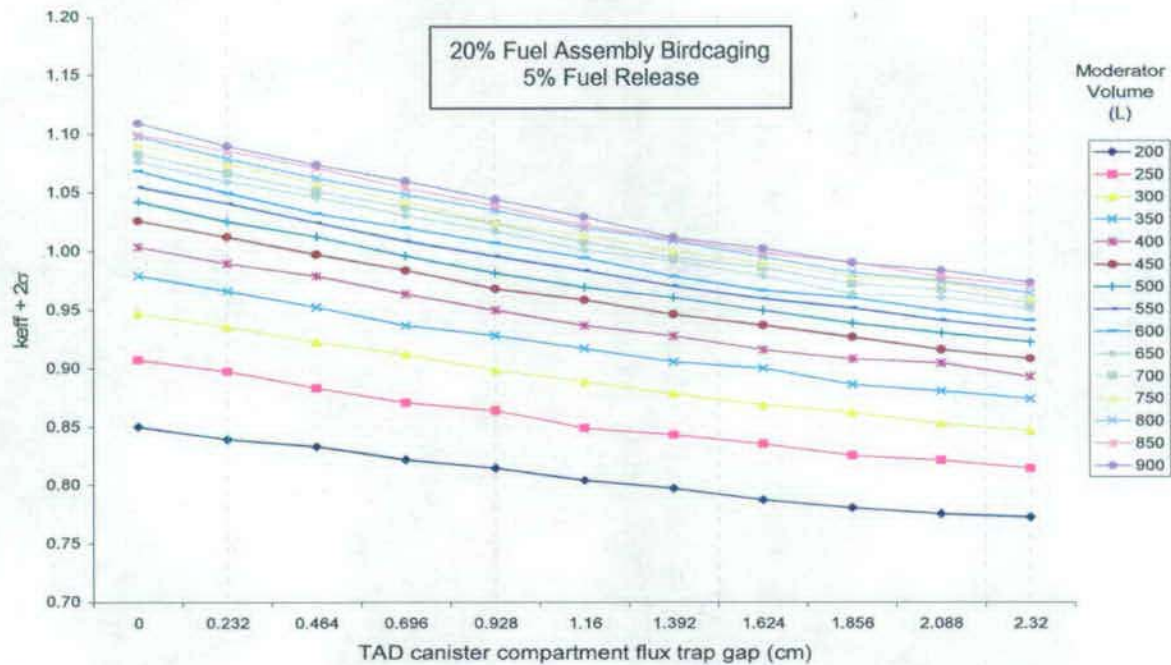

Source: Original

Figure 85. Variation of $k_{eff} + 2\sigma$ for Single Damaged, Partially Flooded PWR TAD Canister (with 30cm Thick Steel Reflector) Containing Representative CSNF with Partial Fuel Deformation (20% Birdcaging) and 5% Fuel Release

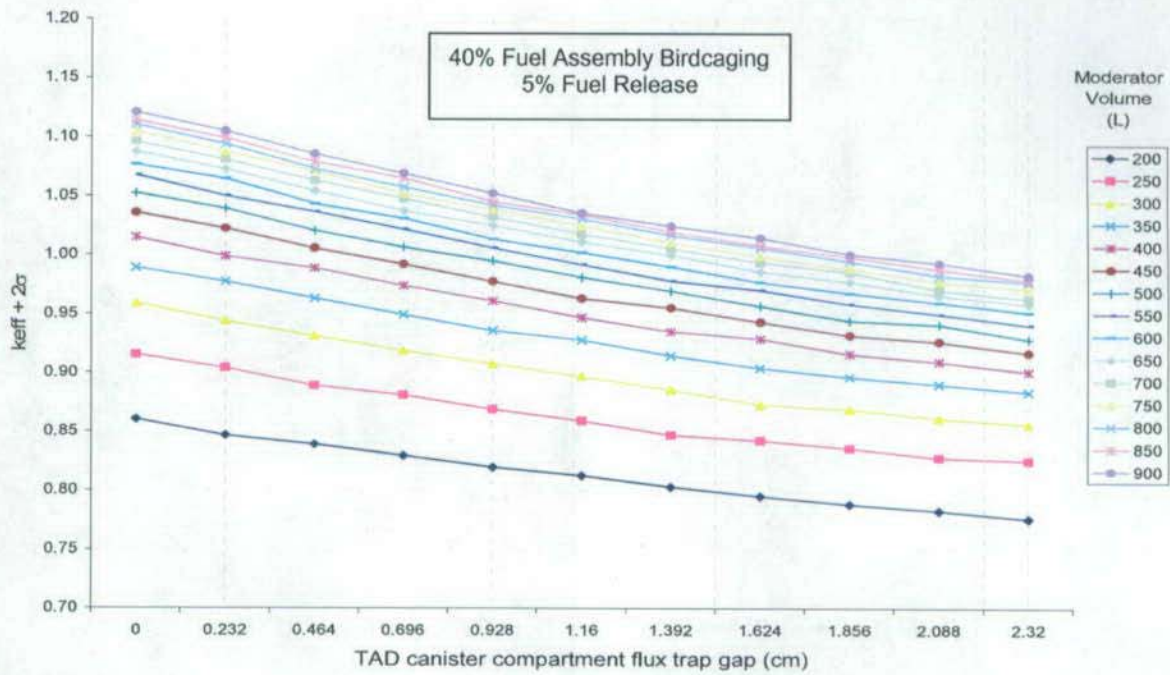

Source: Original

Figure 86. Variation of $k_{eff} + 2\sigma$ for Single Damaged, Partially Flooded PWR TAD Canister (with 30cm Thick Steel Reflector) Containing Representative CSNF with Partial Fuel Deformation (40% Birdcaging) and 5% Fuel Release

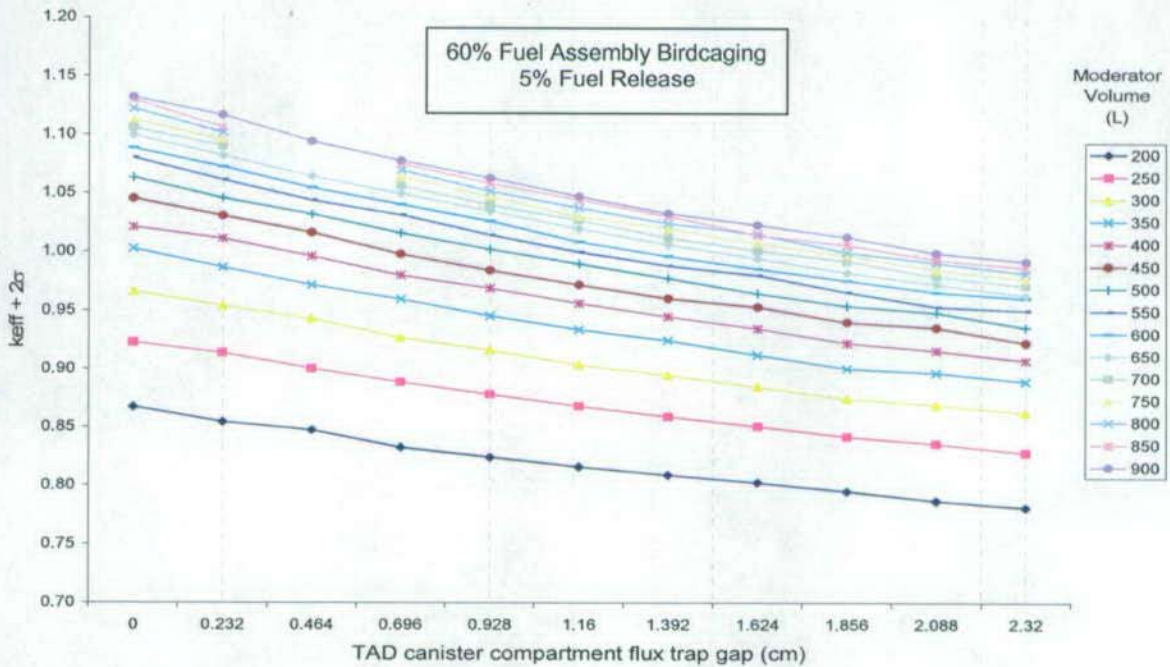

Source: Original

Figure 87. Variation of $k_{eff} + 2\sigma$ for a Single Damaged, Partially Flooded PWR TAD Canister (with 30cm Thick Steel Reflector) Containing Representative CSNF with Partial Fuel Deformation (60% Birdcaging) and 5% Fuel Release

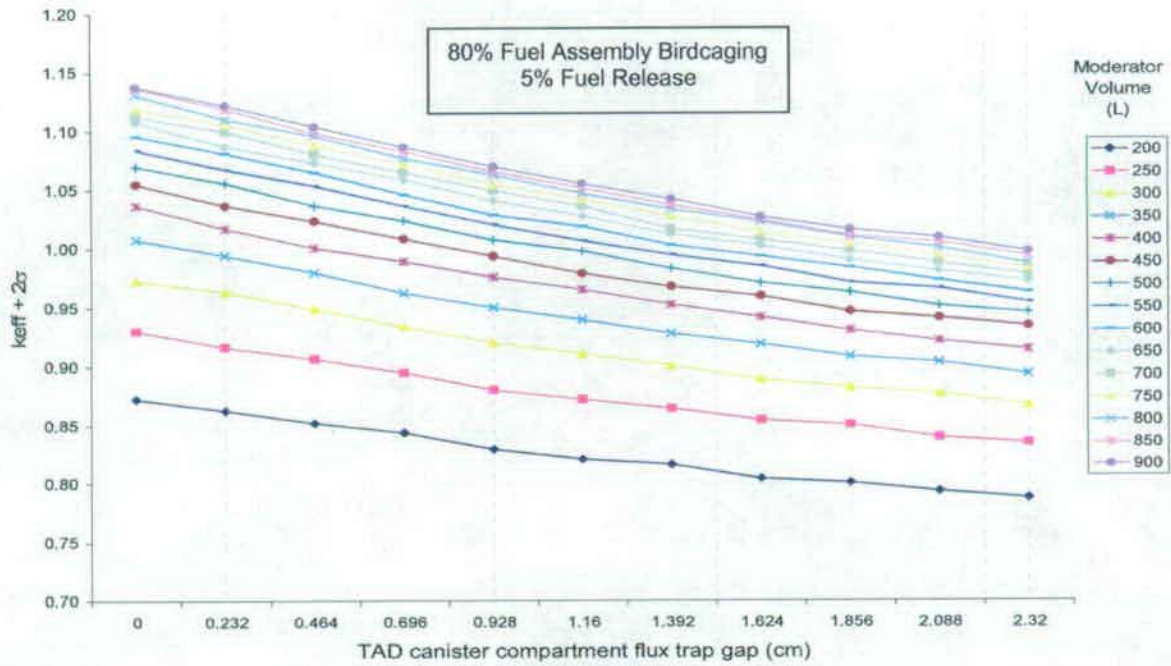

Source: Original

Figure 88. Variation of $k_{eff} + 2\sigma$ for Single Damaged, Partially Flooded PWR TAD Canister (with 30cm Thick Steel Reflector) Containing Representative CSNF with Partial Fuel Deformation (80% Birdcaging) and 5% Fuel Release

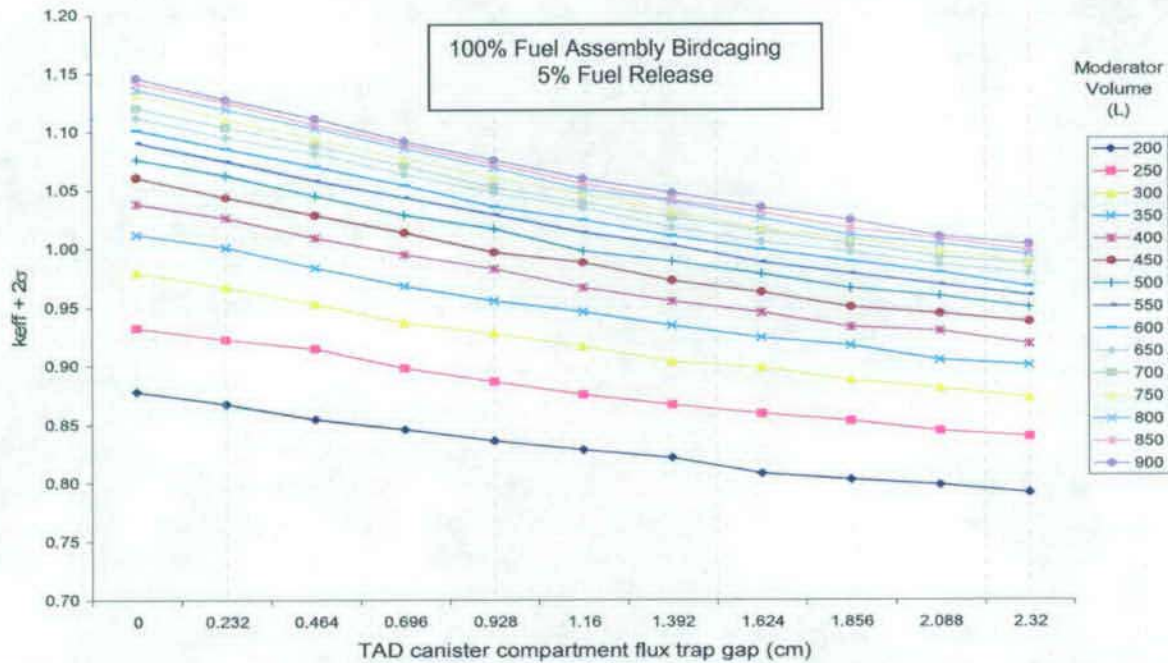

Source: Original

Figure 89. Variation of $k_{eff} + 2\sigma$ for a Single Damaged, Partially Flooded PWR TAD Canister (with 30cm Thick Steel Reflector) Containing Representative CSNF with Maximum Fuel Deformation (100% Birdcaging) and 5% Fuel Release

ATTACHMENT IV: ATTACHMENT DIGITAL VIDEO DISC LISTING

This attachment contains a listing and description of the files contained on the attachment Digital Video Disc (DVD) of this report (Attachment V). The zip archives were created using WINZIP 9.0. The attributes of all files contained on the DVD are as follows:

Filename	File Size (bytes)	File Date	File Time	Description
tad_mcnp_inputs.zip	30,403,000	8/24/07	15:48	Winzip file containing all MCNP input files relevant to this document
tad_mcnp_outputs.zip	3,135,938,000	8/24/07	16:03	Winzip file containing all MCNP output files relevant to this document
tad_canister_calculations.xls	5,960,000	8/28/07	10:32	Microsoft Excel workbook containing all data analysis (i.e. MCNP results processing) relevant to this document
aencf.txt	516,000	7/4/07	18:21	Text file containing MCNP results of the Average Energy of Neutrons Lost to Fission
bwr_calc1_results.txt	1,000	6/6/07	17:05	Text file containing MCNP k-eff results
bwr_calc2_results.txt	1,000	6/6/07	17:05	Text file containing MCNP k-eff results
bwr_calc3_results.txt	1,000	5/21/07	11:23	Text file containing MCNP k-eff results
bwr_calc4_results.txt	3,000	5/21/07	11:25	Text file containing MCNP k-eff results
bwr_calc5_results.txt	1,000	7/02/07	15:19	Text file containing MCNP k-eff results
bwr_calc6_results.txt	201,000	7/04/07	10:03	Text file containing MCNP k-eff results
bwr_calc7_results.txt	2,000	7/02/07	09:10	Text file containing MCNP k-eff results
bwr_calc9_results.txt	228,000	7/04/07	10:05	Text file containing MCNP k-eff results
bwr_calc10_results.txt	2,000	5/21/07	13:40	Text file containing MCNP k-eff results
bwr_calc11_results.txt	2,000	5/21/07	11:20	Text file containing MCNP k-eff results
pwr_calc1_results.txt	2,000	7/02/07	09:08	Text file containing MCNP k-eff results
pwr_calc2_results.txt	2,000	7/02/07	09:06	Text file containing MCNP k-eff results
pwr_calc3_results.txt	2,000	7/02/07	09:12	Text file containing MCNP k-eff results
pwr_calc4_results.txt	3,000	5/21/07	11:22	Text file containing MCNP k-eff results
pwr_calc5_results.txt	1,000	7/02/07	09:05	Text file containing MCNP k-eff results
pwr_calc6_results.txt	195,000	5/21/07	11:36	Text file containing MCNP k-eff results
pwr_calc7_results.txt	2,000	7/02/07	09:10	Text file containing MCNP k-eff results
pwr_calc8_results.txt	3,000	7/04/07	09:46	Text file containing MCNP k-eff results
pwr_calc9_results.txt	205,000	5/21/07	13:30	Text file containing MCNP k-eff results
pwr_calc10_results.txt	2,000	5/21/07	11:35	Text file containing MCNP k-eff results
pwr_calc11_results.txt	1,000	6/6/07	17:03	Text file containing MCNP k-eff results
pwr_calc13_results.txt	1,000	6/6/07	17:04	Text file containing MCNP k-eff results
pwr_calc14_results.txt	568,000	7/04/07	11:52	Text file containing MCNP k-eff results
k _{eff} _all_calcs.txt	1,364,000	7/05/07	13:38	Text file containing MCNP k-eff results
k _{eff} _all_bwr_tad_calcs.txt	434,000	7/05/07	13:45	Text file containing MCNP k-eff results
k _{eff} _all_pwr_tad_calcs.txt	931,000	7/05/07	13:44	Text file containing MCNP k-eff results

There are 7426 total files contained in the zip archive file *tad_mcnp_inputs.zip*, and 7426 total files contained in the zip archive file *tad_mcnp_outputs.zip*. Files suffixed “_in” are input files, whereas files suffixed “_ino” denote output files. Including 1 Microsoft Excel workbook and 27 text files, the DVD contains a total of 14880 files.

OFFICE OF CIVILIAN RADIOACTIVE WASTE MANAGEMENT
SPECIAL INSTRUCTION SHEET

1. QA: QA
Page 1 of 1

This is a placeholder page for records that cannot be scanned.

2. Record Date
11/01/2007

3. Accession Number
Att. To: ENG.20071106.0033

4. Author Name(s)
Matthews, B

5. Authorization Organization
BSC/Pre-closure Criticality Safety

6. Title/Description
Nuclear Criticality Calculations for Canister-Based Facilities – Commercial SNF

7. Document Number(s)
000-00C-MGR0-03600-000

8. Version Designator
00A

9. Document Type
Media

DATA

10. Medium
2 DVD's

11. Access Control Code
PUB

12. Traceability Designator
000-00C-MGR0-03600-000-00A

13. Comments
DVD's: 1 Original
1 Copy

Validation of complete file transferred. All files copied. Software used: Monte Carlo N-Particle (MCNP); Microsoft Excel 2003.

THIS IS AN ELECTRONIC
ATTACHMENT

14. RPC Electronic Media Verification

XREF

MOL.20071114.0087

NOV 14 2007 T Church / BSC-BS

MD5 Validation

ATTACHMENT IV: ATTACHMENT DIGITAL VIDEO DISC LISTING

This attachment contains a listing and description of the files contained on the attachment Digital Video Disc (DVD) of this report (Attachment V). The zip archives were created using WINZIP 9.0. The attributes of all files contained on the DVD are as follows:

Filename	File Size (bytes)	File Date	File Time	Description
tad_mcnp_inputs.zip	30,403,000	8/24/07	15:48	Winzip file containing all MCNP input files relevant to this document
tad_mcnp_outputs.zip	3,135,938,000	8/24/07	16:03	Winzip file containing all MCNP output files relevant to this document
tad_canister_calculations.xls	5,960,000	8/28/07	10:32	Microsoft Excel workbook containing all data analysis (i.e. MCNP results processing) relevant to this document
aencf.txt	516,000	7/4/07	18:21	Text file containing MCNP results of the Average Energy of Neutrons Lost to Fission
bwr_calc1_results.txt	1,000	6/6/07	17:05	Text file containing MCNP k-eff results
bwr_calc2_results.txt	1,000	6/6/07	17:05	Text file containing MCNP k-eff results
bwr_calc3_results.txt	1,000	5/21/07	11:23	Text file containing MCNP k-eff results
bwr_calc4_results.txt	3,000	5/21/07	11:25	Text file containing MCNP k-eff results
bwr_calc5_results.txt	1,000	7/02/07	15:19	Text file containing MCNP k-eff results
bwr_calc6_results.txt	201,000	7/04/07	10:03	Text file containing MCNP k-eff results
bwr_calc7_results.txt	2,000	7/02/07	09:10	Text file containing MCNP k-eff results
bwr_calc9_results.txt	228,000	7/04/07	10:05	Text file containing MCNP k-eff results
bwr_calc10_results.txt	2,000	5/21/07	13:40	Text file containing MCNP k-eff results
bwr_calc11_results.txt	2,000	5/21/07	11:20	Text file containing MCNP k-eff results
pwr_calc1_results.txt	2,000	7/02/07	09:08	Text file containing MCNP k-eff results
pwr_calc2_results.txt	2,000	7/02/07	09:06	Text file containing MCNP k-eff results
pwr_calc3_results.txt	2,000	7/02/07	09:12	Text file containing MCNP k-eff results
pwr_calc4_results.txt	3,000	5/21/07	11:22	Text file containing MCNP k-eff results
pwr_calc5_results.txt	1,000	7/02/07	09:05	Text file containing MCNP k-eff results
pwr_calc6_results.txt	195,000	5/21/07	11:36	Text file containing MCNP k-eff results
pwr_calc7_results.txt	2,000	7/02/07	09:10	Text file containing MCNP k-eff results
pwr_calc8_results.txt	3,000	7/04/07	09:46	Text file containing MCNP k-eff results
pwr_calc9_results.txt	205,000	5/21/07	13:30	Text file containing MCNP k-eff results
pwr_calc10_results.txt	2,000	5/21/07	11:35	Text file containing MCNP k-eff results
pwr_calc11_results.txt	1,000	6/6/07	17:03	Text file containing MCNP k-eff results
pwr_calc13_results.txt	1,000	6/6/07	17:04	Text file containing MCNP k-eff results
pwr_calc14_results.txt	568,000	7/04/07	11:52	Text file containing MCNP k-eff results
k _{eff} _all_calcs.txt	1,364,000	7/05/07	13:38	Text file containing MCNP k-eff results
k _{eff} _all_bwr_tad_calcs.txt	434,000	7/05/07	13:45	Text file containing MCNP k-eff results
k _{eff} _all_pwr_tad_calcs.txt	931,000	7/05/07	13:44	Text file containing MCNP k-eff results