

OCRWM	DESIGN CALCULATION OR ANALYSIS COVER SHEET	1. QA: QA 2. Page 1 of 50
--------------	---	------------------------------

3. System DOE and Commercial Waste Package	4. Document Identifier CAL-DS0-NU-000003 REV 00A
---	---

5. Title
Criticality Model

6. Group
Criticality

7. Document Status Designation

Preliminary
 Final
 Cancelled

8. Notes/Comments

Attachments	Number of Pages
I: Listing of LUTB and MCNP Spectral Characteristic Input and Output Files Contained in Attachment II	4
II: Compact Disc	CDROM and 4 Pages
III: LBTL Calculation and ROA Determination for LWR SNF	50
IV: LBTL Calculation and ROA Determination for Shippingport LWBR	14
V: LBTL Calculation and ROA Determination for Enrico Fermi	18
VI: LBTL Calculation and ROA Determination for N-Reactor	12
VII: LBTL Calculation and ROA Determination for FFTF	10
VIII: LBTL Calculation and ROA Determination for Melt and Dilute Ingots	10
IX: LBTL Calculation and ROA Determination for TRIGA SNF	20
X: LBTL Calculation and ROA Determination for Fort St. Vrain SNF	14
XI: LBTL Calculation and ROA Determination for Shippingport PWR	12
XII: LBTL Calculation and ROA Determination for Configurations External to the Waste Package	40

RECORD OF REVISIONS

9. No.	10. Reason For Revision	11. Total # of Pgs.	12. Last Pg. #	13. Originator (Print/Sign/Date)	14. Checker (Print/Sign/Date)	15. QER (Print/Sign/Date)	16. Approved/Accepted (Print/Sign)	17. Date
00A	Initial Issue Supersedes MDL-EBS-NU-000003 REV 02. Add BWR and external benchmarks and LBTL values. Changes are too extensive to use change bars.	258	XIII-38	Abdelhalim Alsaed <i>aaabacd</i> 09/10/2004	John Scaglione <i>John Scaglione</i> 9/10/04	William N. Dockery <i>William N Dockery</i> 13 SEPT 2004	William Hutchins <i>William Hutchins</i>	9/14/04

INTENTIONALLY LEFT BLANK

EXECUTIVE SUMMARY

*Disposal Criticality Analysis Methodology Topical Report*¹ describes the methodology for performing postclosure criticality analyses for Light Water Reactor and Department of Energy-Environmental Management-owned Spent Nuclear Fuel² within the repository at Yucca Mountain, Nevada. An important component of the methodology is the criticality model. This analysis documents the criticality model and its benchmarking process. The criticality model is to be used for evaluating the criticality potential of configurations of fissionable materials. The criticality model uses the MCNP Monte Carlo computer code to analyze the geometry and materials that define a configuration, and to calculate the effective neutron multiplication factor (k_{eff}). The criticality model is benchmarked so that the range of applicability covers the various configurations of intact and degraded fuel that could occur in the repository over the preclosure and postclosure time periods.

This analysis addresses three open items (13, 15, and 17) from the “Safety Evaluation Report for Disposal Criticality Analysis Methodology Topical Report, Revision 0.”³ These open items are as follows:

Open Item 13: “The DOE should address the types of criticality uncertainties and biases, which is based on ANSI/ANS-8.17-1984, presented by the staff.”

Open Item 15: “The DOE is required to include the isotopic bias and uncertainties as part of Δk_c if not included as isotopic correction factors.”

Open Item 17: “The DOE should subject the method used for extending the trend to the procedures defined in ANSI/ANS-8.1-1998, C4(a) and C4(b).”

Open Items 13, 15 and 17 are addressed in Section 6.3. Uncertainties based on extension of range of applicability and isotopic composition are accounted for in the critical limit calculation. Material and fabrication tolerances and uncertainties due to geometric or material representations used in the computational method are obviated by using bounding representations. The procedures defined in ANSI/ANS-8.1-1998, C4(a) and C4(b) are applied for extending the range of applicability.

This analysis provides a description of the criticality model and benchmarking process, the intended use of the criticality model, the limitations of the criticality model, and a discussion of how the criticality model fits within the overall methodology from *Disposal Criticality Analysis Methodology Topical Report*.

¹ Yucca Mountain Site Characterization Project 2003. Disposal Criticality Analysis Methodology Topical Report. YMP/TR-004Q, Rev. 02D. Las Vegas, Nevada: Yucca Mountain Site Characterization Office. ACC: MOL.20030617.0322. TBV-5172.

² The methodology for performing postclosure criticality analyses within the repository at Yucca Mountain, Nevada for Naval Nuclear Propulsion Program spent nuclear fuel is described in the License Application.

³ Reamer, C.W. 2000. “Safety Evaluation Report for Disposal Criticality Analysis Methodology Topical Report, Revision 0.” Letter from C.W. Reamer (NRC) to S.J. Brocoum (DOE/YMSCO), June 26, 2000, with enclosure. ACC: MOL.20000919.0157.

In this analysis, the criticality model is benchmarked using applicable light water reactor, Department of Energy-owned spent nuclear fuel, and external configurations benchmark experiments.

CONTENTS

	Page
ACRONYMS AND ABBREVIATIONS.....	11
1. PURPOSE	13
2. QUALITY ASSURANCE	15
3. USE OF SOFTWARE.....	15
3.1 MCNP.....	15
3.2 CLREG	16
4. INPUTS	16
4.1 CODES AND STANDARDS.....	16
4.2 MATERIAL CROSS SECTIONS	16
4.2.1 Light Water Reactor Spent Nuclear Fuel Cross Sections.....	17
4.2.2 U.S. Department of Energy Environmental Management-Owned Spent Nuclear Fuel Cross Sections	20
5. ASSUMPTIONS	21
6. METHODOLOGY	22
6.1 PROCESS	22
6.2 COMPUTATIONAL METHOD	23
6.3 ESTABLISHING CRITICALITY POTENTIAL.....	25
6.3.1 Determining the Critical Limit	25
6.4 DISCUSSION OF UNCERTAINTIES	31
6.4.1 Light Water Reactor Spent Nuclear Fuel	31
6.4.2 U.S. Department of Energy Environmental Management-Owned Spent Nuclear Fuel.....	32
6.5 DISCUSSION OF ALTERNATIVES	32
6.5.1 Method Alternatives	32
6.5.2 Code Alternatives	32
6.5.3 Data Set Alternatives.....	33
6.6 CONFIGURATION CLASSES.....	35
6.6.1 In-Package Configuration Classes.....	36
6.6.2 External Configuration Classes	38
7. RESULTS.....	41
8. CONCLUSIONS	43
9. INPUTS AND REFERENCES	43
9.1 DOCUMENTS CITED.....	43
9.2 CODES, STANDARDS, REGULATIONS, AND PROCEDURES.....	48
9.3 SOFTWARE CODES.....	48
10. ATTACHMENTS	49

INTENTIONALLY LEFT BLANK

FIGURES

	Page
Figure 1. Disposal Criticality Analysis Methodology.....	14
Figure 2. Criticality Potential Evaluation Process Overview.....	23
Figure 3. Process for Calculating Lower-Bound Tolerance Limits	29
Figure 4. PWR CRC Eigenvalues	35

INTENTIONALLY LEFT BLANK

TABLES

	Page
Table 1. Selected MCNP ZAIDs for Various Elements and Isotopes for PWR SNF.....	18
Table 2. Selected MCNP ZAIDs for Various Elements and Isotopes for DOE EM- Owned SNF.....	20
Table 3. Principal Isotopes for Commercial SNF Burnup Credit.....	33
Table 4. CRC Fuel Isotopes Set Description	34
Table 5. Criticality Acceptance Criteria for Experiment Subsets.....	42
Table 6. Attachment Listing.....	49

INTENTIONALLY LEFT BLANK

ACRONYMS AND ABBREVIATIONS

AENCF	average energy of a neutron causing fission
ALF	average lethargy of a neutron causing fission
B&W	Babcock & Wilcox
BWR	boiling water reactor
CC	configuration class applicability
CL	critical limit
CRC	commercial reactor critical
DFA	driver fuel assembly
DFTL	distribution free tolerance limit
DOE	U.S. Department of Energy
EALF	energy of average lethargy causing fission
EFPD	effective full power days
ENDF	Evaluated Nuclear Data File
EPRI	Electric Power Research Institute
EROA	extension of the range of applicability
FFTF	Fast Flux Test Facility
HLW	high-level radioactive waste
LBTL	lower-bound tolerance limit
LCE	laboratory critical experiment
LUTB	lower uniform tolerance band
LWBR	light water breeder reactor
LWR	light water reactor
MCO	multicanister overpacks
MOX	mixed oxide
NDTL	normal distribution tolerance limit
PNL	Pacific Northwest Laboratory
PWR	pressurized water reactor
ROA	range of applicability
ROP	range of parameters
SNF	spent nuclear fuel
TRIGA	Training Research Isotopes General Atomics

INTENTIONALLY LEFT BLANK

1. PURPOSE

The *Disposal Criticality Analysis Methodology Topical Report* (YMP 2003) presents the methodology for evaluating potential criticality situations in the monitored geologic repository. As stated in the referenced Topical Report, the detailed methodology for performing the disposal criticality analyses will be documented in model reports. Many of the models developed in support of the Topical Report differ from the definition of models as given in the Office of Civilian Radioactive Waste Management procedure AP-SIII.10Q, *Models*, in that they are procedural, rather than mathematical. These model reports document the detailed methodology necessary to implement the approach presented in the *Disposal Criticality Analysis Methodology Topical Report* and provide calculations utilizing the methodology. Thus, the governing procedure for this type of report is AP-3.12Q, *Design Calculations and Analyses*. The *Criticality Model* is of this latter type, providing a process evaluating the criticality potential of in-package and external configurations.

The purpose of this analysis is to layout the process for calculating the criticality potential for various in-package and external configurations and to calculate lower-bound tolerance limit (LBTL) values and determine range of applicability (ROA) parameters. The LBTL calculations and the ROA determinations are performed using selected benchmark experiments that are applicable to various waste forms and various in-package and external configurations. The waste forms considered in this calculation are pressurized water reactor (PWR), boiling water reactor (BWR), Fast Flux Test Facility (FFTF), Training Research Isotope General Atomic (TRIGA), Enrico Fermi, Shippingport pressurized water reactor, Shippingport light water breeder reactor (LWBR), N-Reactor, Melt and Dilute, and Fort Saint Vrain Reactor spent nuclear fuel (SNF).

The scope of this analysis is to document the criticality computational method. The criticality computational method will be used for evaluating the criticality potential of configurations of fissionable materials (in-package and external to the waste package) within the repository at Yucca Mountain, Nevada for all waste packages/waste forms. The criticality computational method is also applicable to preclosure configurations. The criticality computational method is a component of the methodology presented in *Disposal Criticality Analysis Methodology Topical Report* (YMP 2003). How the criticality computational method fits in the overall disposal criticality analysis methodology is illustrated in Figure 1 (YMP 2003, Figure 3). This calculation will not provide direct input to the total system performance assessment for license application. It is to be used as necessary to determine the criticality potential of configuration classes as determined by the configuration probability analysis of the configuration generator model (BSC 2003a).

Benchmarking of the criticality computational method for potential waste form configuration classes is provided in the attachments to this calculation.

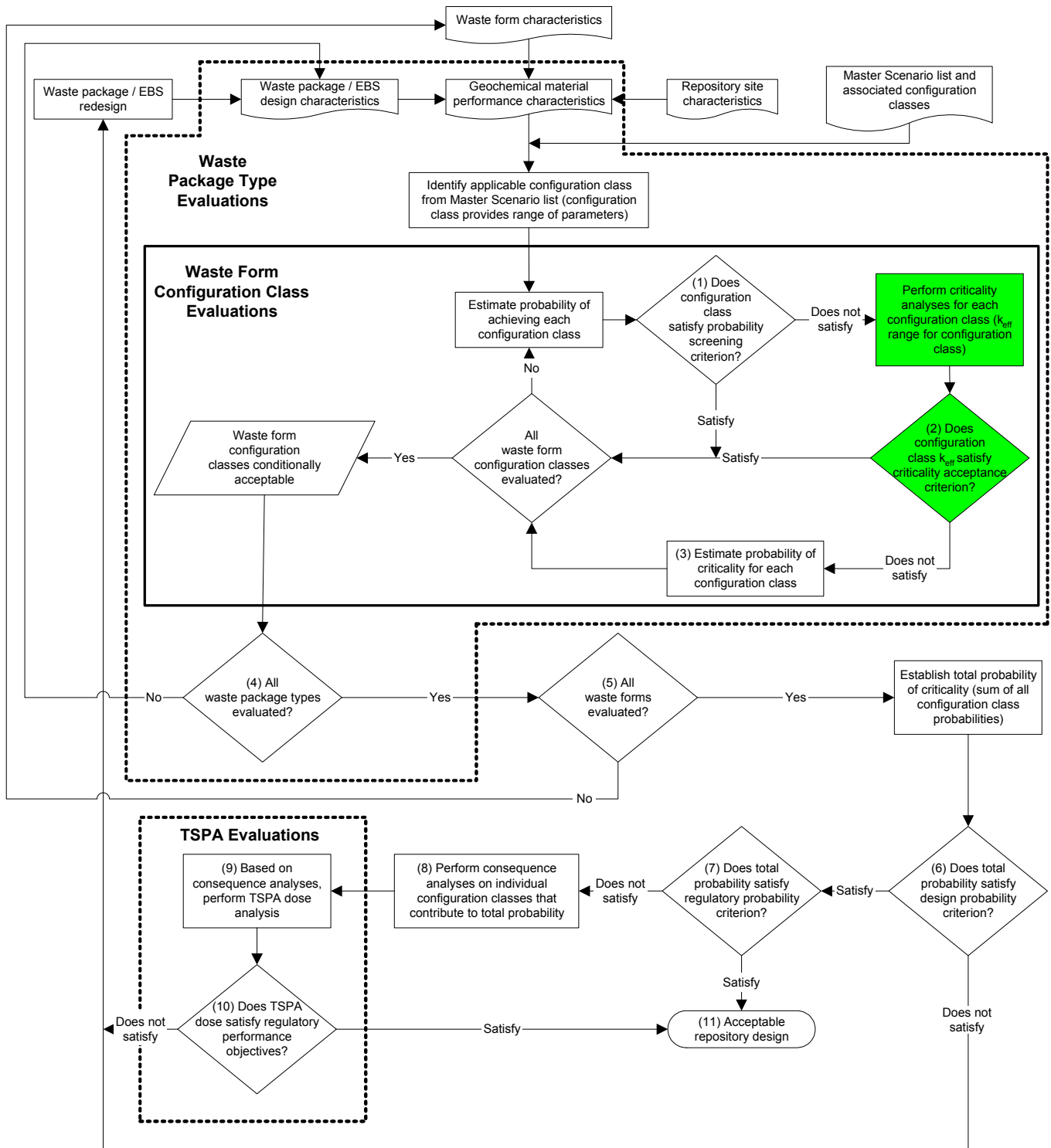

NOTE: EBS = Engineered Barrier System, TSPA = Total System Performance Assessment.

Figure 1. Disposal Criticality Analysis Methodology

This analysis addresses specific Open Items 13, 15, and 17 from the “Safety Evaluation Report for Disposal Criticality Analysis Methodology Topical Report, Revision 0” (Reamer 2000, Section 4), which are as follows:

- Open Item 13: “The DOE should address the types of criticality uncertainties and biases, which is based on ANSI/ANS-8.17-1984, presented by the staff.” (Addressed in Section 6.3)
- Open Item 15: “The DOE is required to include the isotopic bias and uncertainties as part of Δk_c if not included as isotopic correction factors.” (Addressed in Section 6.3.1)
- Open Item 17: “The DOE should subject the method used for extending the trend to the procedures defined in ANSI/ANS-8.1-1998, C4(a) and C4(b).” (Addressed in Section 6.3.1.2).

2. QUALITY ASSURANCE

Development of this analysis and the supporting activities have been determined to be subject to the Yucca Mountain Project’s quality assurance program in Section 8 of *Technical Work Plan for: Criticality Department Work Packages ACRM01 and NSN002* (BSC 2004a). Approved quality assurance procedures identified in the Technical Work Plan (BSC 2004a, Section 4) have been used to conduct and document the activities described in this analysis. The Technical Work Plan also identifies the methods used to control the electronic management of data (BSC 2004a, Section 8) during the analysis and documentation activities.

3. USE OF SOFTWARE

The software used or referenced in this report includes MCNP and CLREG as discussed in Sections 3.1 and 3.2.

3.1 MCNP

The baselined MCNP code (MCNP V4B2LV, CSCI: 30033 V4B2LV) was used in the supporting documentation for k_{eff} calculations. MCNP is used in this report to generate output file tally edits for spectral characteristics, which are documented in Attachment III. The software specifications are as follows:

- Software Title: MCNP
- Version/Revision Number: Version 4B2LV
- Status/Operating System: Qualified/HP-UX B.10.20
- Computer Software Configuration Item Number: 30033 V4B2LV
- Computer Type: Hewlett Packard 9000 Series Workstations.

The input and output files for the MCNP calculations are documented in Attachment I (Attachment I provides a listing of the files contained in Attachment II on compact disc) such that an independent duplication of the software use and the results could be performed.

The MCNP software used was (1) appropriate for the application of k_{eff} and spectral characteristic calculations, (2) used only within the range of validation as documented throughout *MCNP-A General Monte Carlo N-Particle Transport Code* (Briesmeister 1997) and *Software Qualification Report for MCNP Version 4B2, A General Monte Carlo N-Particle Transport Code* (CRWMS M&O 1998a), and (3) obtained from Software Configuration Management in accordance with appropriate procedures.

3.2 CLREG

The CLREG software code (CLREG V1.0, STN: 10528-1.0-01) was used to calculate the LBTL for the benchmark experiments included in this report and extend the range of applicability for the critical limit (CL). The software specifications are as follows:

- Software Title: CLREG
- Version/Revision Number: V1.0
- Status/Operating System: Qualified/Windows 2000
- Software Tracking Number: 10528-1.0-01
- Computer Type: DELL OPTIPLEX GX240 Personal Computer.

CLREG is a computer program that calculates sets of LBTL (LBTL functions) for waste packages under certain conditions. These limits account for the criticality analysis method bias and uncertainty of the calculated k_{eff} values for a set of critical experiments that represent the waste package, as determined by linear regression trending.

The input and output files for the CLREG calculations are included in Attachment II on compact disc, such that an independent duplication of the software use and results could be performed. The CLREG software used was: (1) appropriate for the calculation of LBTL, (2) used only within the range of validation as documented in the CLREG documentation (BSC 2001c), and (3) obtained from Software Configuration Management in accordance with appropriate procedures.

4. INPUTS

4.1 CODES AND STANDARDS

The following standard(s) are used for the bases of this report:

- ANSI/ANS-8.1-1998. Nuclear Criticality Safety in Operations with Fissionable Material Outside Reactors.
- ANSI/ANS-8.17-1984. Criticality Safety Criteria for the Handling, Storage, and Transportation of LWR Fuel Outside Reactors.

4.2 MATERIAL CROSS SECTIONS

Nuclear cross section data are available from several source evaluations (data libraries). Utilizing the appropriate material cross sections in a criticality calculation is essential to

obtaining credible results. The cross sections are used to describe the physical interactions of neutrons with the materials of the SNF and waste package as the nuclear chain reaction process is simulated. The MCNP neutron interaction tables are processed from either the Evaluated Nuclear Data File (ENDF)/B-V, ENDF/B-VI, LLNL, LANL: T-2, or LANL: XTM evaluations. The sources for the neutron interaction tables are listed by material in *MCNP-A General Monte Carlo N-Particle Transport Code* (Briesmeister 1997, Appendix G). The cross sections in an evaluation are usually generated for elements or isotopes at a specific temperature, with a few exceptions, including cross sections for nuclides at multiple temperatures so systems with varying operating temperatures can be evaluated.

For a particular table, the cross sections for each reaction are given on one energy grid that is sufficiently dense so linear-linear interpolation between points reproduces the evaluated cross sections within a specified tolerance, generally within one percent or less of the evaluated data (Briesmeister 1997, p. 2-18).

Neutron interaction table designations are included as part of the material composition input to MCNP. Each material composition is composed of one or more elements or isotopes designated by an identifier that takes the form “ZZZAAA.nnX,” where ZZZ is the atomic number, AAA is the atomic mass, nn is the library identifier, and X is the class of data. A more complete description of the ZAID nomenclature is available in *MCNP-A General Monte Carlo N-Particle Transport Code* (Briesmeister 1997, Appendix G).

4.2.1 Light Water Reactor Spent Nuclear Fuel Cross Sections

Table 1 lists elements and isotopes selected for use in the criticality calculations for PWR and boiling water reactor (BWR) SNF in accordance with *Selection of MCNP Cross Section Libraries* (CRWMS M&O 1998b). The criteria for the cross sections selected included use of standard versions of ENDF/B (ENDF/B-VI and ENDF/B-V, which contain evaluations at the elevated temperatures found in an operating reactor) whenever possible. It should be noted that the calculations of isotopic concentrations by the isotopic model (BSC 2004b) are performed at elevated reactor temperatures, as are the commercial reactor criticals (CRCs). Calculations using the criticality computational method for repository applications are performed using room-temperature cross sections since the temperatures for preclosure and postclosure conditions are lower than reactor temperatures, and it is conservative to use the lowest temperature cross section evaluations for the repository environment. The selected cross section sets are used in Attachment III.

Table 1. Selected MCNP ZAIDs for Various Elements and Isotopes for PWR SNF

Element	Isotope	Cross Section Library ZAID ^a	Element	Isotope	Cross Section Library ZAID	
Hydrogen	¹ H	1001.50c	Barium	¹³⁸ Ba	56138.50c	
	² H	1002.55c	Praseodymium	¹⁴¹ Pr	59141.50c	
	³ H	1003.50c	Neodymium	¹⁴³ Nd	60143.50c	
Helium	³ He	2003.50c		¹⁴⁵ Nd	60145.50c	
	⁴ He	2004.50c	¹⁴⁷ Nd	60147.50c		
Lithium	⁶ Li	3006.50c	Promethium	¹⁴⁸ Nd	60148.50c	
	⁷ Li	3007.55c		¹⁴⁷ Pm	61147.50c	
Beryllium	⁷ Be	4007.35c		¹⁴⁸ Pm	61148.50c	
	⁹ Be	4009.50c		¹⁴⁹ Pm	61149.50c	
Boron	¹⁰ B	5010.50c	Samarium	¹⁴⁷ Sm	62147.50c	
	¹⁰ B	5010.53c		¹⁴⁹ Sm	62149.50c	
	¹¹ B	5011.56c		¹⁵⁰ Sm	62150.50c	
Carbon	C (natural)	6000.50c		¹⁵¹ Sm	62151.50c	
	¹² C	6012.50c		¹⁵² Sm	62152.50c	
	¹³ C	6013.35c		Europium	¹⁵¹ Eu	63151.55c
Nitrogen	¹⁴ N	7014.50c	¹⁵² Eu		63152.50c	
	¹⁵ N	7015.55c	¹⁵³ Eu		63153.55c	
Oxygen	¹⁶ O	8016.50c		¹⁵⁴ Eu	63154.50c	
	¹⁶ O	8016.53c		¹⁵⁵ Eu	63155.50c	
	¹⁶ O	8016.54c		Gadolinium	¹⁵² Gd	64152.50c
	¹⁷ O	8017.60c (B-VI.0)			¹⁵⁴ Gd	64154.50c
Fluorine	¹⁹ F	9019.50c	¹⁵⁵ Gd	64155.50c		
Sodium	²³ Na	11023.50c	¹⁵⁶ Gd	64156.50c		
Magnesium	Mg (natural)	12000.50c	¹⁵⁷ Gd	64157.50c		
Aluminum	²⁷ Al	13027.50c	¹⁵⁸ Gd	64158.50c		
Silicon	Si (natural)	14000.50c	¹⁶⁰ Gd	64160.50c		
Phosphorus	³¹ P	15031.50c	Holmium	¹⁶⁵ Ho	67165.55c	
Sulfur	S (natural)	16000.60c (B-VI.0)	Thulium	¹⁶⁹ Tm	69169.55c	
	³² S	16032.50c	Hafnium	Hf (natural)	72000.50c	
Chlorine	Cl (natural)	17000.50c	Tantalum	¹⁸¹ Ta	73181.50c	
Argon	Ar (natural)	18000.59c		¹⁸² Ta	73182.60c (B-VI.0)	
Potassium	K (natural)	19000.50c	Tungsten	W (natural)	74000.55c	
Calcium	Ca (natural)	20000.50c		¹⁸² W	74182.55c	
	⁴⁰ Ca	20040.21c		¹⁸³ W	74183.55c	
Scandium	⁴⁵ Sc	21045.60c (B-VI.2)		¹⁸⁴ W	74184.55c	
Titanium	Ti (natural)	22000.50c	¹⁸⁶ W	74186.55c		
Vanadium	V (natural)	23000.50c	Rhenium	¹⁸⁵ Re	75185.50c	
Chromium	⁵⁰ Cr	24050.60c (B-VI.1)		¹⁸⁷ Re	75187.50c	
	⁵² Cr	24052.60c (B-VI.1)	Iridium	Ir (natural)	77000.55c	
	⁵³ Cr	24053.60c (B-VI.1)	Platinum	Pt (natural)	78000.35c	
	⁵⁴ Cr	24054.60c (B-VI.1)	Gold	¹⁹⁷ Au	79197.50c	

Table 1. Selected MCNP ZAIDs for Various Elements and Isotopes for PWR SNF (Continued)

Element	Isotope	Cross Section Library ZAID ^a	Element	Isotope	Cross Section Library ZAID
Manganese	⁵⁵ Mn	25055.50c	Lead	Pb (natural)	82000.50c
Iron	⁵⁴ Fe	26054.60c (B-VI.1)		²⁰⁶ Pb	82206.60c (B-VI.0)
	⁵⁶ Fe	26056.60c (B-VI.1)		²⁰⁷ Pb	82207.60c (B-VI.1)
	⁵⁷ Fe	26057.60c (B-VI.1)		²⁰⁸ Pb	82208.60c (B-VI.0)
	⁵⁸ Fe	26058.60c (B-VI.1)	Bismuth	²⁰⁹ Bi	83209.50c
Cobalt	⁵⁹ Co	27059.50c	Thorium	²³⁰ Th	90230.60c (B-VI.0)
Nickel	⁵⁸ Ni	28058.60c (B-VI.1)		²³¹ Th	90231.35c
	⁶⁰ Ni	28060.60c (B-VI.1)		²³² Th	90232.50c
	⁶¹ Ni	28061.60c (B-VI.1)		²³³ Th	90233.35c
	⁶² Ni	28062.60c (B-VI.1)	Protactinium	²³¹ Pa	91231.60c (B-VI.0)
⁶⁴ Ni	28064.60c (B-VI.1)	²³³ Pa		91233.50c	
Copper	⁶³ Cu	29063.60c (B-VI.2)	Uranium	²³² U	92232.60c (B-VI.0)
	⁶⁵ Cu	29065.60c (B-VI.2)		²³³ U	92233.50c
Gallium	Ga (natural)	31000.50c		²³⁴ U	92234.50c
Arsenic	⁷⁴ As	33074.35c		²³⁵ U	92235.50c
	⁷⁵ As	33075.35c		²³⁵ U	92235.53c
Bromine	⁷⁹ Br	35079.55c		²³⁵ U	92235.54c
	⁸¹ Br	35081.55c		²³⁶ U	92236.50c
Krypton	⁷⁸ Kr	36078.50c		²³⁷ U	92237.50c
	⁸⁰ Kr	36080.50c		²³⁸ U	92238.50c
	⁸² Kr	36082.50c		²³⁸ U	92238.53c
	⁸³ Kr	36083.50c		²³⁸ U	92238.54c
	⁸⁴ Kr	36084.50c		²³⁹ U	92239.35c
	⁸⁶ Kr	36086.50c	²⁴⁰ U	92240.35c	
Rubidium	⁸⁵ Rb	37085.55c	Neptunium	²³⁵ Np	93235.35c
	⁸⁷ Rb	37087.55c		²³⁶ Np	93236.35c
Yttrium	⁸⁸ Y	39088.35c		²³⁷ Np	93237.50c
	⁸⁹ Y	39089.50c		²³⁸ Np	93238.35c
Zirconium	Zr (natural)	40000.60c (B-VI.1)	²³⁹ Np	93239.60c (B-VI.0)	
	⁹³ Zr	40093.50c	Plutonium	²³⁶ Pu	94236.60c (B-VI.0)
Niobium	⁹³ Nb	41093.50c		²³⁷ Pu	94237.35c
Molybdenum	Mo (natural)	42000.50c		²³⁸ Pu	94238.50c
	⁹⁵ Mo	42095.50c		²³⁹ Pu	94239.55c
Technetium	⁹⁹ Tc	43099.50c		²⁴⁰ Pu	94240.50c
Ruthenium	¹⁰¹ Ru	44101.50c		²⁴¹ Pu	94241.50c
	¹⁰³ Ru	44103.50c		²⁴² Pu	94242.50c
Rhodium	¹⁰³ Rh	45103.50c		²⁴³ Pu	94243.60c (B-VI.2)
	¹⁰⁵ Rh	45105.50c		²⁴⁴ Pu	94244.60c (B-VI.0)

Table 1. Selected MCNP ZAIDs for Various Elements and Isotopes for PWR SNF (Continued)

Element	Isotope	Cross Section Library ZAID ^a	Element	Isotope	Cross Section Library ZAID
Palladium	¹⁰⁵ Pd	46105.50c	Americium	²⁴¹ Am	95241.50c
	¹⁰⁸ Pd	46108.50c		^{242m} Am	95242.50c
Silver	¹⁰⁷ Ag	47107.60c (B-VI.0)		²⁴³ Am	95243.50c
	¹⁰⁹ Ag	47109.60c (B-VI.0)	Curium	²⁴¹ Cm	96241.60c (B-VI.0)
Cadmium	Cd (natural)	48000.50c		²⁴² Cm	96242.50c
Indium	In (natural)	49000.60c (B-VI.0)		²⁴³ Cm	96243.35c
Tin	Sn (natural)	50000.35c		²⁴⁴ Cm	96244.50c
Iodine	¹²⁷ I	53127.60c (T-2)		²⁴⁵ Cm	96245.35c
	¹²⁹ I	53129.60c (B-VI.0)		²⁴⁶ Cm	96246.35c
	¹³⁵ I	53135.50c		²⁴⁷ Cm	96247.35c
Xenon	Xe (natural)	54000.35c		²⁴⁸ Cm	96248.60c (B-VI.0)
	¹³¹ Xe	54131.50c	Berkelium	²⁴⁹ Bk	97249.60c (B-VI:XTM)
	¹³⁴ Xe	54134.35c	Californium	²⁴⁹ Cf	98249.60c (B-VI:XTM)
	¹³⁵ Xe	54135.50c		²⁵⁰ Cf	98250.60c (B-VI.2))
	¹³⁵ Xe	54135.53c		²⁵¹ Cf	98251.60c (B-VI.2)
¹³⁵ Xe	54135.54c	²⁵² Cf		98252.60c (B-VI.2)	
Cesium	¹³³ Cs	55133.50c			
	¹³⁴ Cs	55134.60c (B-VI.0)			
	¹³⁵ Cs	55135.50c (B-VI.0)			
	¹³⁶ Cs	55136.60c (B-VI.0)			
	¹³⁷ Cs	55137.60c (B-VI.0)			

Source: CRWMS M&O 1998b, Table 4.1

NOTE: ^aInformation in parentheses “()” for the ENDF/B-VI cross sections indicate release number.

4.2.2 U.S. Department of Energy Environmental Management-Owned Spent Nuclear Fuel Cross Sections

Table 2 lists elements and isotopes selected for use in the criticality computational method for the waste package configurations containing various U.S. Department of Energy Environmental Management (DOE EM-Owned) SNF. The selected cross section libraries have been used consistently in the analyses of the applicable critical benchmark experiments (BSC 2002, BSC 2003b).

Table 2. Selected MCNP ZAIDs for Various Elements and Isotopes for DOE EM-Owned SNF

Element	Isotope	Cross Section Library ZAID	Element	Isotope	Cross Section Library ZAID
Hydrogen	¹ H	1001.50c	Molybdenum	Mo (natural)	42000.50c
	² H	1002.55c		⁹⁵ Mo	42095.50c
		³ H	1003.50c	Silver	¹⁰⁷ Ag
Helium	³ He	2003.50c		¹⁰⁹ Ag	47109.50c
	⁴ He	2004.50c	Cadmium	Cd (natural)	48000.50c

Table 2. Selected MCNP ZAIDs for Various Elements and Isotopes for DOE EM-Owned SNF (Continued)

Element	Isotope	Cross Section Library ZAID	Element	Isotope	Cross Section Library ZAID
Lithium	⁶ Li	3006.50c	Tin	Sn (natural)	50000.35c
	⁷ Li	3007.55c	Cesium	¹³³ Cs	55133.50c
Beryllium	⁷ Be	4007.35c		¹³⁵ Cs	55135.50c
	⁹ Be	4009.50c	Barium	¹³⁸ Ba	56138.50c
Boron	¹⁰ B	5010.50c	Gadolinium	Gd (natural)	64000.35c
	¹¹ B	5011.56c		¹⁵² Gd	64152.50c
Carbon	C (natural)	6000.50c		¹⁵⁴ Gd	64154.50c
	¹² C	6012.50c		¹⁵⁵ Gd	64155.50c
	¹³ C	6013.35c		¹⁵⁶ Gd	64156.50c
Nitrogen	¹⁴ N	7014.50c		¹⁵⁷ Gd	64157.50c
	¹⁵ N	7015.55c		¹⁵⁸ Gd	64158.50c
Oxygen	¹⁶ O	8016.50c		¹⁶⁰ Gd	64160.50c
Fluorine	¹⁹ F	9019.50c	Hafnium	Hf (natural)	72000.50c
Sodium	²³ Na	11023.50c	Tantalum	¹⁸¹ Ta	73181.50c
Magnesium	Mg (natural)	12000.50c	Tungsten	W (natural)	74000.55c
Aluminum	²⁷ Al	13027.50c		¹⁸² W	74182.55c
Silicon	Si (natural)	14000.50c		¹⁸³ W	74183.55c
Phosphorus	³¹ P	15031.50c		¹⁸⁴ W	74184.55c
Sulfur	³² S	16032.50c		¹⁸⁶ W	74186.55c
Chlorine	Cl (natural)	17000.50c	Gold	¹⁹⁷ Au	79197.50c
Argon	Ar (natural)	18000.59c	Lead	Pb (natural)	82000.50c
Potassium	K (natural)	19000.50c	Thorium	²³² Th	90232.50c
Calcium	Ca (natural)	20000.50c	Uranium	²³³ U	92233.50c
Titanium	Ti (natural)	22000.50c		²³⁴ U	92234.50c
Vanadium	V (natural)	23000.50c		²³⁵ U	92235.50c
Chromium	Cr (natural)	24000.50c		²³⁶ U	92236.50c
Manganese	⁵⁵ Mn	25055.50c		²³⁷ U	92237.50c
Iron	Fe (natural)	26000.55c		²³⁸ U	92238.50c
Cobalt	⁵⁹ Co	27059.50c	Plutonium	²³⁸ Pu	94238.50c
Nickel	Ni (natural)	28000.50c		²³⁹ Pu	94239.55c
Copper	Cu (natural)	29000.50c		²⁴⁰ Pu	94240.50c
Gallium	Ga (natural)	31000.50c		²⁴¹ Pu	94241.50c
Zirconium	Zr (natural)	40000.56c		²⁴² Pu	94242.50c
Niobium	⁹³ Nb	41093.50c	Americium	²⁴¹ Am	95241.50c

Source: BSC 2003b, Table 5-3

5. ASSUMPTIONS

None

6. METHODOLOGY

6.1 PROCESS

The criticality computational method uses a process for establishing criticality potential of configurations of fissionable materials within the repository at Yucca Mountain, Nevada. A configuration is defined by a set of parameters that characterize the amount and physical arrangement of materials that affect criticality (e.g., fissionable, neutron absorbing, moderating, and reflecting materials). A set of similar configurations whose composition and geometry are defined by specific parameters that distinguish them from other configurations is referred to as a configuration class.

The criticality potential evaluation process follows the methodology described in *Disposal Criticality Analysis Methodology Topical Report* (YMP 2003, Section 3.5.3.2), and the guidance given in ANSI/ANS-8.1-1998, *Nuclear Criticality Safety in Operations with Fissionable Material Outside Reactors*.

An overview of the criticality computational method is presented in Figure 2. As shown in Figure 2, k_{eff} evaluations are performed over the range of parameters (ROP) and parameter values for configurations in each class, as determined by the configuration generator model (BSC 2003a). Input for waste form compositions and characteristics come from waste form characteristics reports and applications of the isotopic model (BSC 2004b). Based on benchmark experiment evaluations, a range of applicability is established and an allowable limit (or CL) is calculated for a given configuration class. This CL, which is the value of k_{eff} at which a configuration is considered potentially critical, accounts for the criticality analysis method bias and uncertainty. The range of parameters and parameter values applied to the k_{eff} evaluations are checked against the range of parameters and parameter values that were used in establishing the CL. The process for establishing CL values is discussed in Section 6.3.1. A description of the process for defining the range of applicability of the CL values based on the experimental database used in establishing the CL values is presented in Section 6.3.1.1. A CL is established applicable to the range of parameter values that are used in the k_{eff} evaluation(s) so a comparison can be made to assess the criticality potential of the configuration(s). If the calculated k_{eff} is less than the CL for all configurations within a class, the configuration class is acceptable for disposal. A configuration class with one or more configurations with calculated k_{eff} values greater than or equal to the CL has the potential for criticality.

Criticality experiments are selected from a group of experiments that include laboratory critical experiment (LCEs) and commercial reactor critical (CRCs) and are used to determine a bias and uncertainty associated with computer code analysis of the experiments. The bias is the deviation of the calculated k_{eff} values from unity. The range of certain physical characteristics of these experiments establish its ROA.

This analysis focuses on in-package and external configurations and parameters. Benchmark experiments applicable to the configuration classes are selected, LBTL are established, and other margins or penalties, as necessary, are established for determining the CL. The term “penalty” is used in conjunction with extension of the ROA. The term “margin” is used to denote further reductions in the CL.

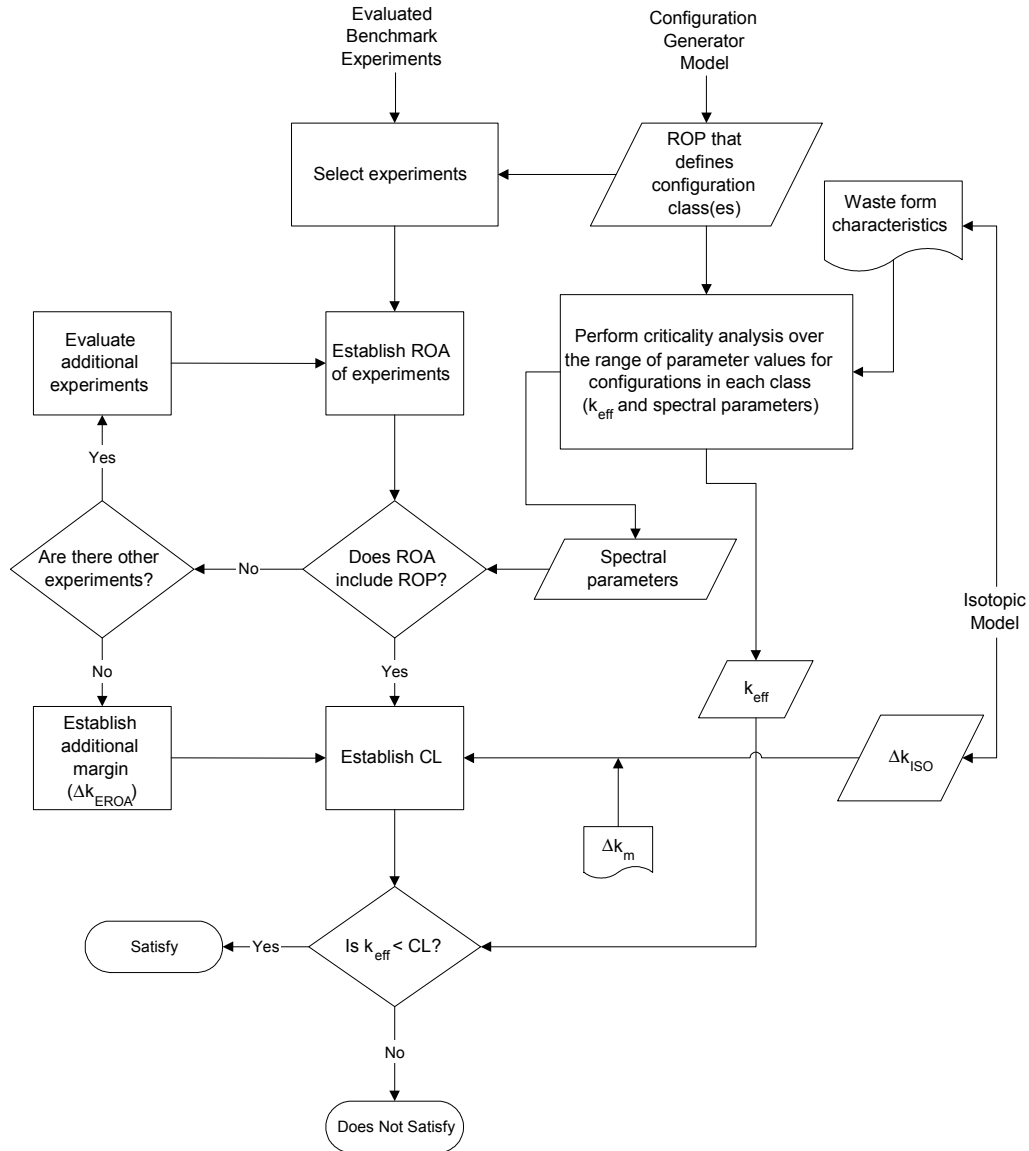

NOTES: Δk_{EROA} = penalty for extending the range of applicability.
 Δk_{ISO} = penalty for isotopic composition bias and uncertainty.
 Δk_m = an arbitrary margin ensuring subcriticality for preclosure and turning the CL function into an upper subcritical limit function (it is not applicable for use in postclosure analyses because there is no risk associated with a subcritical event).
 CL = critical limit, ROA = range of applicability, ROP = range of parameters.

Figure 2. Criticality Potential Evaluation Process Overview

6.2 COMPUTATIONAL METHOD

The criticality potential evaluation process applies the Monte Carlo simulation method (implemented by MCNP) along with the material cross section data identified in Tables 1 and 2 in calculating the k_{eff} for potential waste package configurations. The Monte Carlo simulation

method for representing neutron transport can best be described by the Neutron Transport Equation shown in Equation 1 (Duderstadt and Hamilton 1976, p. 113).

$$\frac{\partial n}{\partial t} + v\Omega \cdot \nabla n + v\Sigma_t n(r, E, \Omega, t) = \int_{4\pi} d\Omega' \int_0^\infty dE' v'\Sigma_s(E' \rightarrow E, \Omega' \rightarrow \Omega) n(r, E', \Omega', t) + s(r, E, \Omega, t) \quad (\text{Eq. 1})$$

where (a complete description of all variables is provided by Duderstadt and Hamilton [1976, pp. 103 to 114])

- r = coordinates in space (x, y, z)
- Ω = neutron direction defined in terms of the spherical coordinate angles Θ and Φ
- t = time
- E = energy
- $n()$ = neutron density specification
- $s()$ = neutron source specification
- v = velocity.

MCNP is a general purpose computer code that can be used for neutron, photon, electron, or coupled neutron/photon/electron transport including the capability to calculate eigenvalues for various systems. The code treats an arbitrary three-dimensional configuration of materials in geometric cells bounded by first- and second-degree surfaces and fourth-degree elliptical tori (Briesmeister 1997, p. ix). The Monte Carlo method is used to theoretically duplicate a statistical process. The individual probabilistic events that comprise a process are simulated sequentially. The probability distributions governing these events are statistically sampled to describe the total phenomenon (Briesmeister 1997, p. 1-3).

The Monte Carlo method allows explicit geometrical representation of material configurations. The appropriate material cross section data, as described in Section 4.2, is used. The accuracy of the Monte Carlo method for criticality calculations is limited only by the accuracy of the material cross section data, a correct explicit representation of the geometry, and the duration of the computation. The accuracy of the method and cross section data is established by evaluating critical experiments as shown in Attachments III through XII.

MCNP calculates the following three k_{eff} estimates for each cycle in a given problem:

1. Collision
2. Absorption
3. Track length.

A detailed description of the three k_{eff} estimates may be found in *MCNP-A General Monte Carlo N-Particle Transport Code* (Briesmeister 1997, Chapter 2, Section VIII, Part B). The k_{eff} estimate used in the criticality analyses and in the bias value determination is the statistical combination of all three k_{eff} estimates.

6.3 ESTABLISHING CRITICALITY POTENTIAL

The criticality potential is determined by the final comparison of a configuration's k_{eff} with the applicable CL. This will determine which configuration classes have a potential for criticality. In equation notation the criticality potential criterion for a waste package system is as follows:

$$k_s + \Delta k_s < \text{CL} \quad (\text{Eq. 2})$$

where

k_s = Calculated system k_{eff}

Δk_s = An allowance for:

(a) statistical and convergence uncertainties, or both in the computation of k_s ,

(b) material and fabrication tolerances, and

(c) uncertainties due to the geometric or material representations used in the computational method

(Note: (b) and (c) can be obviated by using bounding representations)

CL = The value of k_{eff} at which a configuration is considered potentially critical, accounting for the criticality analysis method bias and uncertainty, and any additional uncertainties (i.e., Δk_{EROA} or Δk_{ISO} , or both).

The criticality computational method provides a means for calculating k_s and Δk_s using the Monte Carlo method and material cross section data identified in Tables 1 and 2 as implemented by MCNP. The criticality computational method also provides a means for determining the penalty for extending the range of applicability (EROA) (Δk_{EROA}) in the CL calculation, and allows the determination of whether a configuration has the potential for criticality. Additional uncertainty arising from isotopic composition calculations will be propagated to the CL calculation through the isotopic model (BSC 2004b).

6.3.1 Determining the Critical Limit

An essential element of the criticality computational method used for calculating k_{eff} for a waste form configuration is the determination of the CL. The CL includes the bias and uncertainties associated with the criticality code and representation process. The CL for a configuration class is a limiting value of k_{eff} at which a configuration is considered potentially critical. The CL is characterized by statistical tolerance limits that account for biases and uncertainties associated with the criticality code trending process, and any uncertainties due to extrapolation outside the range of experimental data, or limitations in the geometrical or material representations used in the computational method.

The CL is represented as:

$$CL(x) = f(x) - \Delta k_{\text{EROA}} - \Delta k_{\text{ISO}} - \Delta k_m \quad (\text{Eq. 3})$$

where

- x = a neutronic parameter used for trending
- f(x) = the lower-bound tolerance limit function accounting for biases and uncertainties that cause the calculation results to deviate from the true value of k_{eff} for a critical experiment, as reflected over an appropriate set of critical experiments
- Δk_{EROA} = penalty for extending the range of applicability
- Δk_{ISO} = penalty for isotopic composition bias and uncertainty
- Δk_m = an arbitrary margin ensuring subcriticality for preclosure and turning the CL function into an upper subcritical limit function (it is not applicable for use in postclosure analyses because there is no risk associated with a subcritical event).

A CL is associated with a specific type of waste package and its state (intact or various stages of degradation described by the master scenarios [YMP 2003, Figures 3-2a and 3-2b]). The CL is characterized by a representative set of benchmark criticality experiments. This set of criticality experiments also prescribes the basic range of applicability of the results.

The steps that must be completed to establish a CL are: (1) selection of benchmark experiments, (2) establishment of the range of applicability of the benchmark experiments (identification of physical and spectral parameters that characterize the benchmark experiments), (3) establishment of a LBTL, and (4) establishment of additional uncertainties due to extrapolations or limitations in geometrical or material representations.

6.3.1.1 Range of Applicability

In ANSI/ANS-8.1-1998 (p. 1), the term “area of applicability” means “the limiting ranges of material compositions, geometric arrangements, neutron energy spectra and other relevant parameters (such as heterogeneity, leakage, interaction, absorption, etc.) within which the bias of a calculational method is established.” The term “area of applicability” and ROA are used interchangeably here.

When evaluating biases and uncertainties and choosing parameters (or areas) for which a bias would exhibit a trend, there are three fundamental areas (Lichtenwalter et al. 1997, p. 179) that should be considered:

1. Materials of the waste package and the waste form, especially the fissionable materials
2. Geometry of the waste package and waste forms
3. Inherent neutron energy spectrum affecting the fissionable materials.

There are substantial variations within each of these categories that require further considerations. These are discussed by Lichtenwalter et al. (1997, p. 180). Quantifying the

various categories of parameters is complicated and generally requires approaches that use benchmark experiments characterized by a limited set of physical and computed neutron parameters and then compared with the neutronic parameters of a waste package. In this case, the application is a particular waste package in various forms of degradation as defined by the master scenarios (YMP 2003, Figures 3-2a and 3-2b).

In the general practice of characterizing biases and trends in biases, one would first look at those fundamental parameters that might create a bias. That is, those parameters that could be in error with the most significant effect on the accuracy of the calculation. Important areas for evaluating criticality are configuration geometry, important materials concentration (reflecting materials, moderating materials, fissionable materials, and significant neutron absorbing materials), and nuclear cross sections characterizing the nuclear reaction rates that will occur in a system containing fissionable and absorbing materials.

It is desirable for the range of the fundamental parameters of the benchmark critical experiments to encompass the range of the fundamental parameters of the system. This is not usually practical, and for those parameters that do not show a bias, it is acceptable to use critical benchmark experiments that cover most, but not all, of the ROP of the system under evaluation. In these situations, expert judgement may be used to determine if there is a reasonable assurance that the two are sufficiently close.

6.3.1.2 Extension of the Range of Applicability

This section describes a process for extending the ROA. The means used to extend the ROA will depend on a number of factors, including (1) the nature of the critical experiments used to determine the ROA and trends with biases, (2) the particular waste form involved, and (3) the availability of other proven computer codes or methods used to evaluate the situation.

The process described in ANSI/ANS-8.1-1998 (p. 18, C4) is used for the extension of the range of applicability:

The area (or areas) of applicability of a calculational method may be extended beyond the range of experimental conditions over which the bias is established by making use of correlated trends in the bias. Where the extension is large, the method should be:

- Subjected to a study of the bias and potentially compensating biases associated with individual changes in materials, geometries or neutron spectra. This will allow changes that can affect the extension to be independently validated. In practice this can be accomplished in a step-wise approach; that is, benchmarks for the validation should be chosen (where possible) such that the selected experiments differ from previous experiments by the addition of one new parameter so the effect of only the new parameter on the bias can be observed.
- Supplemented by alternative calculational methods to provide an independent estimate of the bias (or biases) in the extended area (or areas) of applicability.

If a ROA is extended where there is a trend in the data without the use of additional experiments, additional penalty will be added to determine whether a system is critical. The penalty for EROA (Δk_{EROA}) will be subtracted from the LBTL as part of establishing a CL for a prescribed parameter range. The following techniques for extending the ROA when there are trends may be used to determine the additional penalty: (1) expert judgment (an evaluation by someone skilled by training and experience in criticality analysis); (2) sensitivity analysis; (3) statistical evaluation of the importance of these parameters, including regression analyses of more than one additional selected experiment with more than one predictor variable; or (4) comparison with other credible methods (code-to-code comparisons).

For situations where a bias (trend) is not established, there are two options for extending the ROA. If the extension of the ROA is small and the understanding of the performance of the criticality code for these parameter ranges is also understood, it would be appropriate to use the established lower-bound tolerance limit and an appropriate penalty. If the extension is not small then more data covering the ROA will be necessary. When more data are obtained, the process shown in Figure 2 must be applied to the new data set. This applies when the ROA for fundamental parameters (material concentrations, geometry, or nuclear cross sections) does not cover the ROP of the waste package configuration and no trend is exhibited.

6.3.1.3 Lower-Bound Tolerance Limit

A LBTL function may be expressed as a regression-based function of neutronic or physical variable(s), or both. In application, a LBTL function could also be a single value, reflecting a conservative result over the range of applicability for the waste form characterized.

Geometric representation and inputs for computing the k_{eff} for a critical experiment with a criticality code often induce bias in the resulting k_{eff} value. Bias is a measure of the systematic differences between the results of a calculational method and experimental data. Uncertainty is a measure of the random error associated with the difference between the calculated and measured result. These k_{eff} values deviate from the expected result ($k_{\text{eff}} = 1$) of benchmark sets of critical experiments. The experimental value of k_{eff} for some benchmarks may not be unity (some are extrapolations to critical); however, this value is used for purposes of calculating errors.

The application of statistical methods to biases and uncertainties of k_{eff} values is determined by trending criticality code results for a set of benchmark critical experiments that will be the basis of establishing lower-bound tolerance limits for a waste form. This process involves obtaining data on various neutronic parameters that are associated with the set of critical experiments used to benchmark the code-calculated values for k_{eff} . These data, with the calculated values of k_{eff} , are the basis of the calculation of the LBTL.

The purpose of the LBTL function is to translate the benchmarked k_{eff} values from the criticality code to a design parameter for a waste form–waste package combination. This design parameter is used in criticality potential criteria. The LBTL definition addresses biases and uncertainties that cause the calculation results to deviate from the true value of k_{eff} for a critical experiment, as reflected over an appropriate set of critical experiments.

Figure 3 displays the following general processes for establishing LBTL functions: (1) regression-based methods reflecting criticality code results over a set of critical experiments that can be trended, and (2) random sample based methods that apply when trending is not an appropriate explanation of criticality code calculations.

The regression approach addresses the calculated values of k_{eff} as a trend of neutronic and physical parameters. That is, regression methods are applied to the set of k_{eff} values to identify trending with such parameters. The trends show the results of systematic errors or bias inherent in the calculational method used to estimate criticality. In some cases, a data set may be valid, but might not cover the full range of parameters used to characterize the waste form. The area (or areas) of applicability of a calculational method may be extended beyond the range of the experimental conditions of the data set over which the bias is established by making use of correlated trends in the bias.

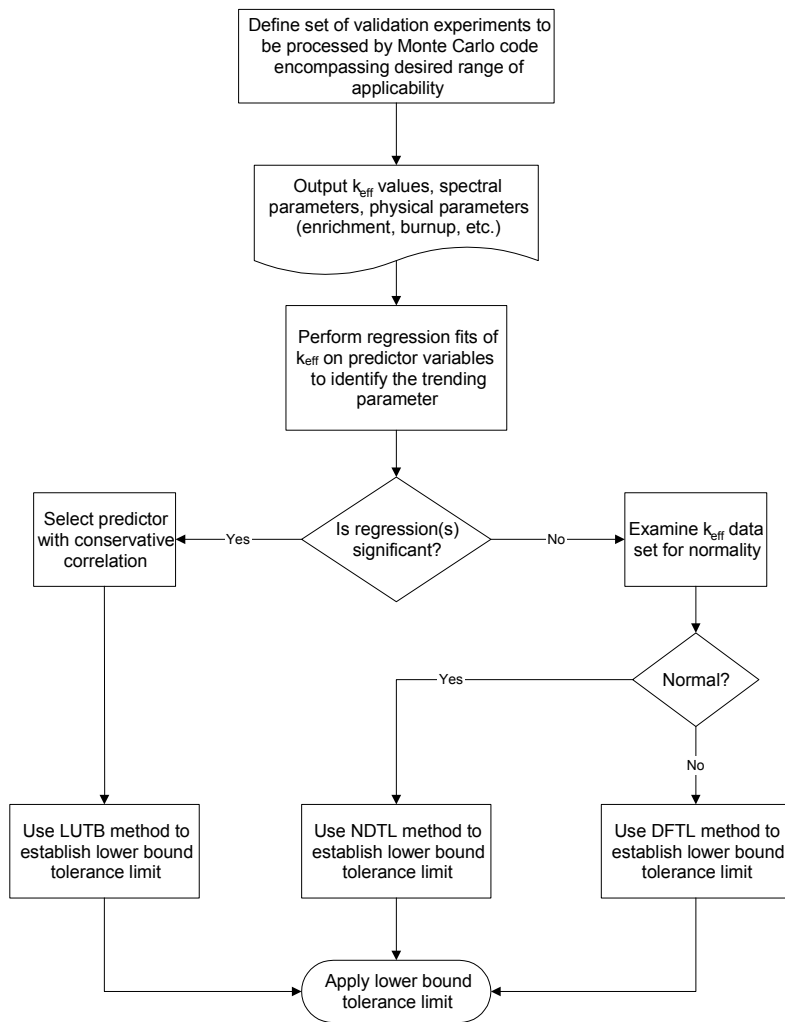

NOTE: DFTL = distribution free tolerance limit, NDTL = normal distribution tolerance limit, LUTB = lower uniform tolerance band.

Figure 3. Process for Calculating Lower-Bound Tolerance Limits

If no trend is identified, a single value may be established for a lower-bound tolerance limit that provides the desired statistical properties associated with the definition of this quantity. The data are treated as a random sample of data (criticality code values of k_{eff}) from the waste form population of interest and straightforward statistical techniques are applied to develop the LBTL. For purposes of differentiation, this technique will be described as “nontrending.” The normal distribution tolerance limit (NDTL) method and the distribution-free tolerance limit method, discussed in *Disposal Criticality Analysis Methodology Topical Report* (YMP 2003, Sections 3.5.3.2.8 and 3.5.3.2.9), are “nontrending” methods.

The regression or “trending” methods use statistical tolerance values based on linear regression techniques to establish a LBTL function. Trending in this context is linear regression of k_{eff} on the predictor variable(s). Statistical significance of trending is determined by the test of the hypothesis that the regression method mean square error is zero (YMP 2003, Section 3.5.3.2.6). Here the predictor variable(s) may be a parameter such as burnup or a parameter that indicates the distribution of neutrons within the system such as the average energy of a neutron that causes either fission or absorption. Where multiple candidates are found for trending purposes, each regression method will be applied and the conservative parameter will be used to determine the value of the LBTL. The lower uniform tolerance band (LUTB) method, discussed in *Disposal Criticality Analysis Methodology Topical Report* (YMP 2003, Section 3.5.3.2.7), trends a single parameter against k_{eff} . Multiple regression methods that trend multiple parameters against k_{eff} may also be used to establish the LBTL function. In either single or multiple situations, the statistically significant regression trend that produces the lowest LBTL is defined to be the more conservative regression.

In all calculations of LBTL functions, the concept described as the “no positive bias” (Lichtenwalter et al. 1997, p. 160) rule must be accommodated. This rule excludes benefits for raising the LBTL for cases in which the best estimate of the bias trend would result in a LBTL greater than 1.0. The treatment of this element is discussed below in the context of each method used to establish the basic LBTL function.

The LBTL function is defined as:

$$f(x) = k_C(x) - \Delta k_C(x) \quad (\text{Eq. 4})$$

where

- x = parameter vector used for trending
- $k_C(x)$ = the value obtained from a regression of the calculated k_{eff} of benchmark critical experiments or the mean value of k_{eff} for the data set if there is no trend
- $\Delta k_C(x)$ = the uncertainty of k_C based on the statistical scatter of the k_{eff} values of the benchmark critical experiments, accounting for the standard deviation, the proportion of the population covered, and the size of the data set.

The statistical description of the scatter quantifies the variation of the data set about the expected value and the contribution of the variability of the calculation of the k_{eff} values for the benchmark critical experiments.

Based on a given set of critical experiments, the LBTL is estimated as a function ($f [x]$) of a parameter(s). Because both $\Delta k_C (x)$ and $k_C (x)$ can vary with this parameter, the LBTL function is typically expressed as a function of this parameter vector, within an appropriate range of applicability derived from the parameter bounds, and other characteristics that define the set of critical experiments.

The calculational bias, β , is defined as

$$\beta = k_C - 1 \quad (\text{Eq. 5})$$

and thus the uncertainty in the bias is identical to the uncertainty in k_C (i.e., $\Delta k_C = \Delta \beta$). This makes the bias negative if k_C is less than 1.0 and positive if k_C is greater than 1.0.

To prevent taking credit for a positive bias, the lower-bound tolerance limit is further reduced by a positive bias adjustment. The positive bias adjustment sets k_C equal to 1.0 when k_C exceeds 1.0.

6.4 DISCUSSION OF UNCERTAINTIES

6.4.1 Light Water Reactor Spent Nuclear Fuel

Due to a lack of prototypic SNF criticality benchmark experiments (LCEs using SNF), and the wide range of potential configurations of waste package internal components over the regulatory period of the repository, a combination of LCEs and CRCs are necessary. The establishment of the MCNP code bias can be made using the LCEs and CRCs to provide Δk_C (discussed in Attachments III through XI) needed for the determination of the CL.

Sources and impacts of uncertainty for commercial SNF involve the following:

- CRC calculations of k_{eff} are performed at elevated reactor temperatures. However, not all isotopes in the selected MCNP cross section library have tabulated cross section data available at elevated reactor temperatures, although ^{235}U is available at higher temperatures, as is ^{238}U , which dominates the SNF inventory and resonance absorption. This uncertainty is inherent in the computed code bias.
- An integral benchmark approach is used with regard to CRCs. The calculation of SNF isotopic material compositions produces uncertainty in the calculated SNF inventory that is used as input to MCNP. This uncertainty is accounted for by the isotopic model (BSC 2004b) and is assessed as an additional penalty on the CL.
- Additional bias and uncertainty is caused by the water scattering kernel. A scattering kernel is used to adjust cross section data for the effects of molecular bonding, which is particularly important for the hydrogen as the principal means of slowing down neutrons to thermal energies that can cause fission in SNF. Water at higher temperatures (e.g., 587 K) will require benchmark cases (CRCs) to use a higher-temperature scattering kernel, while lower-temperature systems (e.g., waste package and LCEs) will use a lower-temperature kernel (e.g., 300 K). In a water-moderated thermal neutron

system, higher-temperature scattering results in more energetic scattering reactions, thereby causing the system to have a slightly harder neutron spectrum. This will result in a slightly lower k_{eff} than if using the lower-temperature scattering kernel. Therefore, this bias and uncertainty is accounted for by using the higher-temperature scattering kernel for computations of code bias from the CRCs, but using the lower-temperature kernel for applications in the waste package configurations.

6.4.2 U.S. Department of Energy Environmental Management-Owned Spent Nuclear Fuel

There are no additional uncertainties associated with the criticality computational method for the selected DOE EM-Owned SNF types analyzed in this report and the cross section data identified in Table 2 other than those inherent to cross section data evaluations, which are already taken into account by using the process described in this analysis.

6.5 DISCUSSION OF ALTERNATIVES

Alternative methods and alternative code implementations of Monte Carlo, as well as alternate nuclear data sets, were considered.

6.5.1 Method Alternatives

The Monte Carlo option is not the only means of solving the Neutron Transport Equation (Equation 1). Other solution methodologies include the Discrete Ordinates Method (Duderstadt and Hamilton 1976, pp. 117 to 120) and the Diffusion Theory Method (Duderstadt and Hamilton 1976, pp. 149 to 226). Both of these methodologies have been used successfully in reactor applications. The principal advantage of the Monte Carlo methodology over the Discrete Ordinates Method is that the Monte Carlo approach facilitates solutions in complex geometries like the waste package. Diffusion theory codes do not work well in the presence of strong neutron absorbers, such as the boron contained in the steel of the waste package basket structure. Thus, the Monte Carlo methodology provides the strongest alternative for repository criticality calculations.

6.5.2 Code Alternatives

The Monte Carlo simulation of the Neutron Transport Equation is implemented in a number of different computer codes. MCNP is one of the best known codes and is supported by Los Alamos National Laboratory. An alternative code supported by Oak Ridge National Laboratory is the KENO code, which is part of the SCALE system (CRWMS M&O 2000d). KENO is often used by the U.S. Nuclear Regulatory Commission to check calculations for spent nuclear fuel casks, as is the British MONK code. The KENO code requires that its nuclear data libraries (typically derivatives of ENDF/B) be prepared explicitly for the type of fuel to be analyzed, because the neutron spectrum of the fuel is used in the preparation of a compressed form of the nuclear data library. The variable neutron spectra of different fuel configurations under repository conditions would make it difficult to prepare an appropriate KENO library. MCNP and MONK do not require such nuclear data compression. MONK must be purchased via a commercial license, while MCNP is a DOE-supported code. Thus, MCNP is the preferred implementation of the Monte Carlo methodology.

6.5.3 Data Set Alternatives

6.5.3.1 Light Water Reactor Spent Nuclear Fuel

The criticality analysis that will be applied in evaluating waste package designs for commercial SNF uses a subset of the isotopes present in commercial SNF. The process for establishing the isotopes to be included is based on the nuclear, physical, and chemical properties and the presence of the commercial SNF isotopes in the nuclear data library. The nuclear properties considered are cross sections and half-lives of the isotopes; the physical properties are concentration (amount present in the SNF) and state (solid, liquid, or gas); and the chemical properties are the volatility and solubility of the isotopes. Time effects (during disposal) and relative importance of isotopes for criticality (combination of cross sections and concentrations) are considered in this selection process. None of the isotopes with significant positive reactivity effects (fissionable isotopes or isotopes that are significant moderators or reflectors) are removed from consideration, only nonfissile absorbers that are not significant moderators or reflectors. Thus, the selection process is conservative from a nuclear criticality perspective.

The selection process results in 14 actinides and 15 fission products (referred to as principal isotopes) as the SNF isotopes to be used for burnup credit applications. Table 3 lists these isotopes. The actinide ^{233}U from this table is not present in current generation commercial SNF. However, for long disposal time periods (beyond the regulatory period of concern), ^{233}U buildup is sufficient to be a potential criticality concern. Analyses supporting the selection of these isotopes are presented in *Principal Isotope Selection Report* (CRWMS M&O 1998c).

Table 3. Principal Isotopes for Commercial SNF Burnup Credit

^{95}Mo	^{145}Nd	^{151}Eu	^{236}U	^{241}Pu
^{99}Tc	^{147}Sm	^{153}Eu	^{238}U	^{242}Pu
^{101}Ru	^{149}Sm	^{155}Gd	^{237}Np	^{241}Am
^{103}Rh	^{150}Sm	^{233}U	^{238}Pu	$^{242\text{m}}\text{Am}$
^{109}Ag	^{151}Sm	^{234}U	^{239}Pu	^{243}Am
^{143}Nd	^{152}Sm	^{235}U	^{240}Pu	

CRCs are used to support the selection of the principal isotopes. This was accomplished by using SNF depleted isotopic inventories calculated using the SAS2H control module of the SCALE code package as discussed in *Summary Report of Commercial Reactor Critical Analyses Performed for the Disposal Criticality Analysis Methodology* (CRWMS M&O 1998d), using reactor operating history data from four different PWRs: Three Mile Island Unit 1, Crystal River Unit 3, Sequoyah Unit 2, and McGuire Unit 1. In addition, SNF from one BWR—Grand Gulf Unit 1—was also used. The reactor operating history information, pertinent details regarding assembly design schematics, and loading patterns were obtained from several technical reports (Punatar 2001a; CRWMS M&O 1998e; CRWMS M&O 1998f; Wimmer 2001; and Punatar 2001b). Four different sets of burned fuel isotopes, in addition to ^{16}O , were represented for each of the PWR CRC statepoints: best-estimate (consisting of up to 84 isotopes); principal isotopes (consisting of 29 “most important with respect to reactivity” fission products and actinides); principal actinides (consisting of 14 isotopes from uranium, plutonium, and americium); and

actinide only (consisting of 10 major actinide elements found in spent nuclear fuel). The isotope sets used are presented in Table 4.

The CRC benchmark cases evaluated cover an initial enrichment range of 1.93 to 4.167 weight percent ²³⁵U and an assembly average burnup range of 0.0 to 49.0 GWd/MTU. Core average burnups range from 0 GWd/MTU for the beginning of life CRC statepoints to 33 GWd/MTU. Figure 4 illustrates the k_{eff} values from the PWR CRC benchmark results that were taken from *Summary Report of Commercial Reactor Critical Analyses Performed for the Disposal Criticality Analysis Methodology* (CRWMS M&O 1998d, pp. 40 to 43). The results indicate, as expected, that as the number of SNF isotopes represented increases, the scatter in the k_{eff} values decrease. The significance of this observation is that as the fuel composition is more accurately represented, the uncertainty in the bias decreases.

Table 4. CRC Fuel Isotopes Set Description

Isotope	Set ^a	Isotope	Set ^a	Isotope	Set ^a	Isotope	Set ^a
³ H	BE	¹⁰⁸ Pd	BE	¹⁵³ Eu	BE, PI	²³⁸ Pu	BE, PI, PA, AO
⁴ He	BE	¹⁰⁷ Ag	BE	¹⁵⁴ Eu	BE	²³⁹ Pu	BE, PI, PA, AO
⁶ Li	BE	¹⁰⁹ Ag	BE, PI	¹⁵⁴ Eu	BE	²⁴⁰ Pu	BE, PI, PA, AO
⁷ Li	BE	¹³¹ Xe	BE	¹⁵² Gd	BE	²⁴¹ Pu	BE, PI, PA, AO
⁹ Be	BE	¹³⁴ Xe	BE	¹⁵⁴ Gd	BE	²⁴² Pu	BE, PI, PA, AO
¹⁶ O	BE, PI, PA, AO	¹³⁵ Cs	BE	¹⁵⁵ Gd	BE, PI	²⁴¹ Am	BE, PI, PA, AO
⁷⁵ As	BE	¹³⁸ Ba	BE	¹⁵⁶ Gd	BE	²⁴² Am	BE, PI, PA
⁸⁰ Kr	BE	¹⁴¹ Pr	BE	¹⁵⁷ Gd	BE	²⁴³ Am	BE, PI, PA
⁸² Kr	BE	¹⁴³ Nd	BE, PI	¹⁵⁸ Gd	BE	²⁴² Cm	BE
⁸³ Kr	BE	¹⁴⁵ Nd	BE, PI	¹⁶⁰ Gd	BE	²⁴³ Cm	BE
⁸⁴ Kr	BE	¹⁴⁷ Nd	BE	²³³ Pa	BE	²⁴⁴ Cm	BE
⁸⁶ Kr	BE	¹⁴⁸ Nd	BE	²³³ U	BE, PI, PA	²⁴⁵ Cm	BE
⁸⁹ Y	BE	¹⁴⁷ Pm	BE	²³⁴ U	BE, PI, PA, AO	²⁴⁶ Cm	BE
⁹³ Zr	BE	¹⁴⁸ Pm	BE	²³⁵ U	BE, PI, PA, AO	²⁴⁷ Cm	BE
⁹³ Nb	BE	¹⁴⁹ Pm	BE	²³⁶ U	BE, PI, PA, AO	²⁴⁸ Cm	BE
⁹⁵ Mo	BE, PI	¹⁴⁷ Sm	BE, PI	²³⁷ U	BE	¹³⁵ Xe	BE
⁹⁹ Tc	BE, PI	¹⁴⁹ Sm	BE, PI	²³⁸ U	BE, PI, PA, AO	¹³³ Cs	BE
¹⁰¹ Ru	BE, PI	¹⁵⁰ Sm	BE, PI	²³⁵ Np	BE	¹⁶⁵ Ho	BE
¹⁰³ Ru	BE	¹⁵¹ Sm	BE, PI	²³⁶ Np	BE	²³² Th	BE
¹⁰³ Rh	BE, PI	¹⁵² Sm	BE, PI	²³⁷ Np	BE, PI, PA		
¹⁰⁵ Rh	BE	¹⁵¹ Eu	BE, PI	²³⁸ Np	BE		
¹⁰⁵ Pd	BE	¹⁵² Eu	BE	²³⁷ Pu	BE		

NOTE: ^aBE = best-estimate; PI = principal isotope; PA = principal actinide; AO = actinide only.

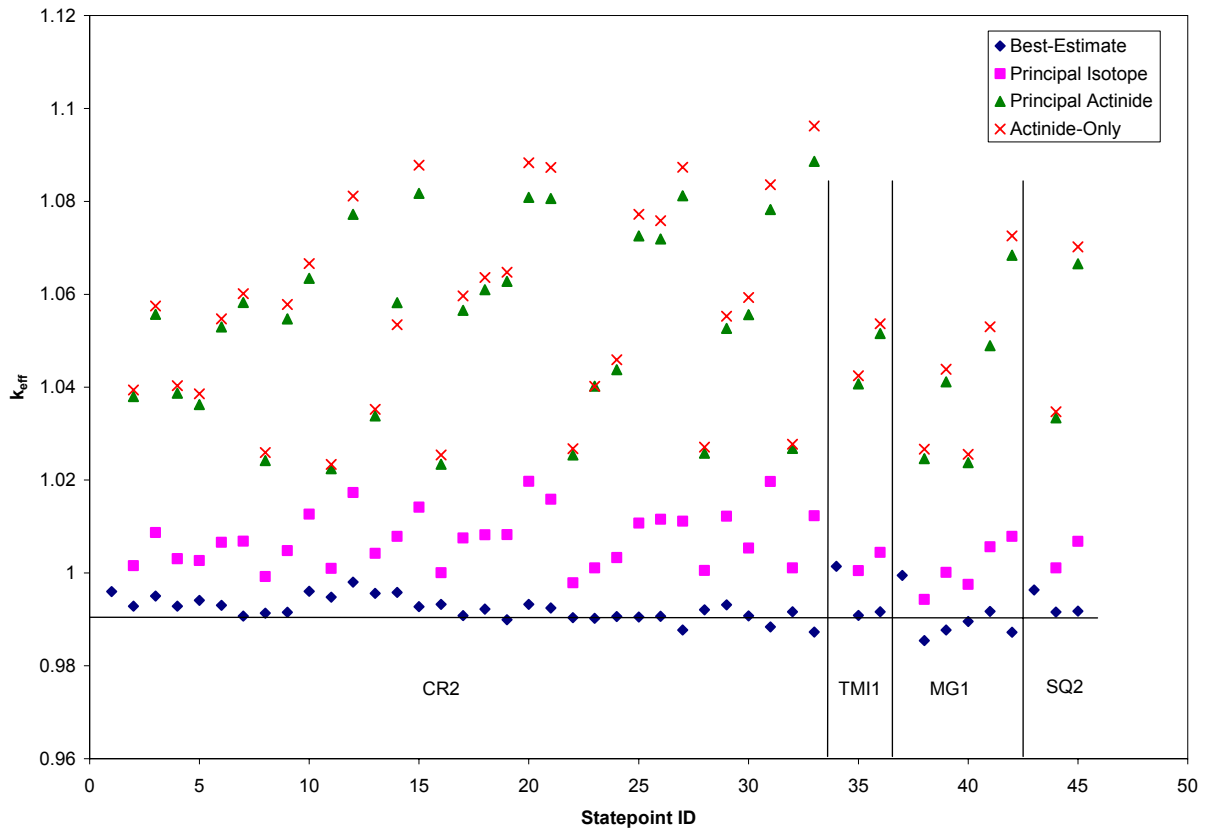

Source: CRWMS M&O 1998d, pp. 40 to 43

NOTE: CR3 (Crystal River Unit 3), SQ2 (Sequoyah Unit 2), MG1 (McGuire Unit 1), TMI1 (Three Mile Island Unit 1).

Figure 4. PWR CRC Eigenvalues

6.5.3.2 U.S. Department of Energy Environmental Management-Owned Spent Nuclear Fuel

There are no alternative data sets for the DOE EM-Owned SNF types mentioned in this report.

6.6 CONFIGURATION CLASSES

A standard set of degradation scenarios based on features, events, and processes that may affect criticality have been identified in the *Disposal Criticality Analysis Methodology Topical Report* (YMP 2003, Section 3.3) that must be considered as part of the criticality analysis of any waste form. Following degradation scenario chains to their end-states results in a series of configurations. A configuration is defined by a set of parameters characterizing the quantity and physical arrangement of materials at a specific location that have a significant effect on criticality (e.g., fissile materials, neutron absorbing materials, reflecting materials, and moderators). A configuration class is a set of similar configurations whose composition and geometry are defined by specific parameters that distinguish one class from another. Within a class, the configuration parameters may vary over a given range.

The scenarios are grouped according to three general locations for potentially critical degraded configurations: (1) inside the waste package, (2) outside the waste package in the near-field environment, and (3) outside the waste package in the far-field environment.

6.6.1 In-Package Configuration Classes

Configuration Class IP-1a: For this configuration class, the fissile material separates from the neutron absorber, which remains in place within the waste package. This configuration class can be reached from scenario IP-1 presented in *Disposal Criticality Analysis Methodology Topical Report* (YMP 2003, Figure 3-2a) where the waste form degrades faster than the waste package internal structures. In this configuration class, the neutron absorber is not released from its carrier before the waste form degrades and the fissionable material degrades in place.

Configuration Class IP-1b: For this configuration class, the fissile material separates from the neutron absorber, which remains in place within the waste package. This configuration class can be reached from scenario IP-1 presented in *Disposal Criticality Analysis Methodology Topical Report* (YMP 2003, Figure 3-2a) where the waste form degrades faster than the waste package internal structures. The neutron absorber is not released from its carrier before the waste form degrades and the degraded waste form is mobilized. The mobilized fissionable material accumulates at the bottom of the waste package. A mechanism to mobilize the degraded waste form is needed.

Configuration Class IP-2a: For this configuration class, both the waste package internal structures and the waste form degrade simultaneously. The corrosion product composition is a mixture of fissile material and degradation products from other internal structures. This configuration class can be reached from scenario IP-2 presented in *Disposal Criticality Analysis Methodology Topical Report* (YMP 2003, Figure 3-2a) and will result in the fissionable material accumulating at the bottom of the waste package. Since both fissionable waste form and waste package internal structures are fully degraded, with all the soluble degradation products removed, the only residual effect of a difference in degradation rates is the nature of any separation between the degradation products of the fissionable waste form and waste package internal structures. Intermediate configurations in which only the basket or the waste form is degraded first are covered by scenario IP-1 (configuration classes IP-1a and IP-1b), or scenario IP-3 (configuration classes IP-3a, IP-3b, IP-3c, and IP-3d).

Configuration Class IP-3a: For this configuration class, the waste package internal structures degrade, but the waste form remains relatively intact. This configuration class can be reached from scenario IP-3 presented in *Disposal Criticality Analysis Methodology Topical Report* (YMP 2003, Figure 3-2a), and results in an intact waste form at the bottom of the waste package surrounded by, and/or beneath, the degraded corrosion products.

Configuration Class IP-3b: For this configuration class, the waste package internal structures degrade but the waste form remains relatively intact. This configuration class can be reached from scenario IP-3 presented in *Disposal Criticality Analysis Methodology Topical Report* (YMP 2003, Figure 3-2a). This configuration class has the waste package internal basket structure collapsing with the waste form and degraded corrosion products stratified. Neutron absorbers are flushed from the waste package.

Configuration Class IP-3c: For this configuration class, the waste package internal structures degrade but the waste form remains relatively intact. This configuration class can be reached from scenario IP-3 presented in *Disposal Criticality Analysis Methodology Topical Report* (YMP 2003, Figure 3-2a). This configuration class is characterized by the complete degradation of the basket structure support and neutron absorber plates. The soluble neutron absorber is flushed from the waste package. Two paths that lead to this configuration class apply to the waste package design in which either the basket structural support degrades prior to the neutron absorber plates or the neutron absorber plates degrade prior to the waste package internal structures.

Configuration Class IP-3d: For this configuration class, the waste package internal structures degrade but the waste form remains relatively intact. This configuration class can be reached from scenario IP-3 presented in *Disposal Criticality Analysis Methodology Topical Report* (YMP 2003, Figure 3-2a). The neutron absorbing structure degrades significantly before structural collapse occurs. The absorber separates from the waste form and remains inside the waste package. The waste form and waste package internal structures maintain their integrity.

Configuration Class IP-4a: For this configuration class, the fissile material degrades faster than the waste package internal structures in a flow through geometry and moves away from the neutron absorber, which remains in the waste package. This configuration class can be reached from scenario IP-4 presented in *Disposal Criticality Analysis Methodology Topical Report* (YMP 2003, Figure 3-2b). In this configuration class, the waste form degrades prior to the neutron absorber being released from its carrier. The fissionable material remains in place to be locked in by its own hydration or by the hydration of waste package internal structures.

Configuration Class IP-4b: For this configuration class, the fissile material degrades faster than the waste package internal structures in a flow through geometry and moves away from the neutron absorber, which remains in the waste package. This configuration class can be reached from scenario IP-4 presented in *Disposal Criticality Analysis Methodology Topical Report* (YMP 2003, Figure 3-2b). This configuration class considers the mobilization of the degraded waste form and its separation from the neutron absorber. The mobilized fissionable material hydrates and collects with other hydrated corrosion products and accumulates at the waste package bottom. A mechanism to mobilize the degraded waste form is needed.

Configuration Class IP-5a: For this configuration class, both the waste package internal structures and waste form have degraded at similar rates. This configuration class can be reached from scenario IP-5 presented in *Disposal Criticality Analysis Methodology Topical Report* (YMP 2003, Figure 3-2b) (i.e., flow-through geometry occurring either before or after the waste form and basket degrade and hydrated products collect at the bottom of waste package). Flow-through flushing removes soluble neutron absorbers. This configuration class can also be obtained from degradation scenarios IP-1 or IP-3. In IP-1, the waste form degrades faster than the basket, and in IP-3, the basket degrades faster than the waste form, but ultimately the waste form and other internal components degrade and accumulate at the bottom of the waste package.

Configuration Class IP-6a: For this configuration class, the waste package internal structures degrade faster than the waste form. This configuration class can be reached from scenario IP-6 presented in *Disposal Criticality Analysis Methodology Topical Report* (YMP 2003,

Figure 3-2b). The waste form is relatively intact and sitting at the bottom of the waste package either surrounded by or beneath the degraded corrosion products. This configuration class is also obtained from degradation scenario IP-3 where the neutron absorber and waste package basket structure have significantly degraded before the waste package bottom failure.

6.6.2 External Configuration Classes

External accumulation of fissile material can occur in the near-field or the far-field. The near-field is defined as the invert, which is the part of the drift that is directly underneath the waste package. The invert is made up of crushed tuff with a high porosity. The far-field is defined as several meters of tuff underneath the drift, which has a distribution of fractures and lithophysae (cavities in the rock).

6.6.2.1 Near-Field (NF) Configuration Classes

Configuration Class NF-1a: For this configuration class, fissionable material accumulates in fractures and other void spaces of the near-field. This configuration class can be reached from scenario NF-1 presented in *Disposal Criticality Analysis Methodology Topical Report* (YMP 2003, Figure 3-3a). This configuration is obtained from processes such as adsorption (sorption) of fissile materials in tuff as a result of a reducing reaction.

Configuration Class NF-1b: For this configuration class, fissionable material accumulates in fractures and other void spaces of the near-field. This configuration class can be reached from scenario NF-1 presented in *Disposal Criticality Analysis Methodology Topical Report* (YMP 2003, Figure 3-3a). This configuration is obtained from chemistry changes due to carrier plume interaction with surrounding rock and pore waters that result in precipitation of fissile material by tuff.

Configuration Class NF-1c: For this configuration class, fissionable material accumulates at the low point of the emplacement drift (or any connecting drift). This configuration class can be reached from scenario NF-1 presented in *Disposal Criticality Analysis Methodology Topical Report* (YMP 2003, Figure 3-3a). The scenario leading to this configuration class must have a mechanism for sealing the fractures in the drift floor so that the effluent from individual waste packages can flow to, and accumulate at, a low point in the drift or repository, possibly in combination with effluent from other waste packages. Such a pool would be expected to occur only within a short time (weeks or less) following a high infiltration episode.

Configuration Class NF-2a: For this configuration class, fissionable material accumulates at the surface of the invert due to filtration by the degradation products, or remnants, of the waste package and its contents, for the cases in which the fissionable material may be carried as a slurry. This configuration class can be reached from scenario NF-2 presented in *Disposal Criticality Analysis Methodology Topical Report* (YMP 2003, Figure 3-3a).

Configuration Class NF-3a: For this configuration class, fissionable material accumulates at the surface of the invert due to filtration by the degradation products, or remnants, of the waste package and its contents, for the cases in which the fissionable material may be carried as a colloid. This configuration class can be reached from scenario NF-3 presented in *Disposal Criticality Analysis Methodology Topical Report* (YMP 2003, Figure 3-3a).

Configuration Class NF-3b: For this configuration class, fissionable material accumulates by processes involving the formation, transport, and eventual breakup (or precipitation) of fissionable material containing colloidal particles. This configuration class can be reached from scenario NF-3 presented in *Disposal Criticality Analysis Methodology Topical Report* (YMP 2003, Figure 3-3a). This configuration class is characterized by the final accumulation in the invert in open fractures of solid material.

Configuration Class NF-3c: For this configuration class, fissionable material accumulates by processes involving the formation, transport, and eventual breakup (or precipitation) of fissionable material containing colloidal particles. This configuration class can be reached from scenario NF-3 presented in *Disposal Criticality Analysis Methodology Topical Report* (YMP 2003, Figure 3-3a). This configuration class is characterized by the final accumulation in the invert in pore space of granular material.

Configuration Class NF-4a: For this configuration class, fissionable material accumulates in water that has pooled in the drift. This configuration class can be reached from scenario NF-4 presented in *Disposal Criticality Analysis Methodology Topical Report* (YMP 2003, Figure 3-3a). This configuration class is reached from the scenario involving waste packages that may not have been directly subjected to dripping water but are located in a local depression so that water from other dripping sites may collect around the bottom of the package during periods of high flow.

Configuration Class NF-5a: This configuration class has the intact or degraded waste form in water that has pooled in the drift. This configuration class can be reached from scenario NF-5 presented in *Disposal Criticality Analysis Methodology Topical Report* (YMP 2003, Figure 3-3a). This configuration class is a variant of NF-4a. Such a configuration class would be evaluated for waste forms that could be demonstrated to be more robust with respect to aqueous corrosion than their waste package materials.

6.6.2.2 Far-Field Configuration Classes

Configuration Class FF-1a: For this configuration class, fissionable material accumulates by precipitation in fractures and other void spaces of the far-field. This configuration class can be reached from scenario FF-1 presented in *Disposal Criticality Analysis Methodology Topical Report* (YMP 2003, Figure 3-3b). This configuration is obtained from processes such as adsorption, from a reducing reaction, or from chemistry changes made possible by carrier plume interaction with surrounding rock and pore waters.

Configuration Class FF-1b: For this configuration class, fissionable material accumulates by sorption, onto clay or zeolite. Such material may be encountered beneath the repository. This configuration class can be reached from scenario FF-1 presented in *Disposal Criticality Analysis Methodology Topical Report* (YMP 2003, Figure 3-3b).

Configuration Class FF-1c: For this configuration class, fissionable material accumulates by precipitation from encountering perched water (groundwater deposit isolated from the nominal flow and not draining because of impermeable layer beneath) having significantly different chemistry from the fissionable material carrier plume. This configuration class can be reached

from scenario FF-1 presented in *Disposal Criticality Analysis Methodology Topical Report* (YMP 2003, Figure 3-3b).

Configuration Class FF-2a: For this configuration class, fissionable material accumulates by processes involving the formation, transport, and eventual breakup (or precipitation) of fissionable material containing colloidal particles. This configuration class can be reached from scenario FF-2 presented in *Disposal Criticality Analysis Methodology Topical Report* (YMP 2003, Figure 3-3b). It has been suggested that the colloid-forming tendency of plutonium will enhance its transport capability, providing the potential for accumulation at some significant distance from the waste package. This configuration class is characterized by the final accumulation in dead-end fractures.

Configuration Class FF-2b: For this configuration class, fissionable material accumulates by processes involving the formation, transport, and eventual breakup (or precipitation) of fissionable material containing colloidal particles. This configuration class can be reached from scenario FF-2 presented in *Disposal Criticality Analysis Methodology Topical Report* (YMP 2003, Figure 3-3b). It has been suggested that the colloid-forming tendency of plutonium will enhance its transport capability, providing the potential for accumulation at some significant distance from the waste package. This configuration class is characterized by the final accumulation in clay or zeolites.

Configuration Class FF-2c: For this configuration class, fissionable material accumulates by processes involving the formation, transport, and eventual breakup (or precipitation) of fissionable material containing colloidal particles. This configuration class can be reached from scenario FF-2 presented in *Disposal Criticality Analysis Methodology Topical Report* (YMP 2003, Figure 3-3b). It has been suggested that the colloid-forming tendency of plutonium will enhance its transport capability, providing the potential for accumulation at some significant distance from the waste package. This configuration class is characterized by the final accumulation in topographically low regions.

Configuration Class FF-3a: For this configuration class, fissionable material accumulates by precipitation in the saturated zone at the contact between the waste-package plume and a hypothetical up welling fluid. This configuration class can be reached from scenario FF-3 presented in *Disposal Criticality Analysis Methodology Topical Report* (YMP 2003, Figure 3-3b).

Configuration Class FF-3b: For this configuration class, fissionable material accumulates by precipitation in the saturated zone at the contact between the waste-package plume and a redox front (where the plume meets a different groundwater chemistry so that an oxidation-reduction reaction can take place). This configuration class can be reached from scenario FF-3 presented in *Disposal Criticality Analysis Methodology Topical Report* (YMP 2003, Figure 3-3b).

Configuration Class FF-3c: For this configuration class, fissionable material accumulates by chemical reduction of fissionable material by a mass of organic material (reducing zone). Such a deposit might be located beneath the repository. This configuration class can be reached from scenario FF-3 presented in *Disposal Criticality Analysis Methodology Topical Report* (YMP 2003, Figure 3-3b).

Configuration Class FF-3d: For this configuration class, fissionable material accumulates by chemical reduction of fissionable material by a mass of organic material (reducing zone). Such a deposit might be located at a narrowing of the tuff aquifer. This configuration class can be reached from scenario FF-3 presented in *Disposal Criticality Analysis Methodology Topical Report* (YMP 2003, Figure 3-3b).

Configuration Class FF-3e: For this configuration class, fissionable material accumulates by chemical reduction of fissionable material by a mass of organic material (reducing zone). Such a deposit might be located at the surface outfall of the saturated zone flow. This configuration class can be reached from scenario FF-3 presented in *Disposal Criticality Analysis Methodology Topical Report* (YMP 2003, Figure 3-3b).

7. RESULTS

The criticality potential evaluation process results in establishing biases and uncertainties over the range of parameters of benchmark experiments. Criticality acceptance criteria for various waste forms are summarized in Table 5. The lower-bound tolerance limits are equivalent to the CL for the ROA of the experiment subsets provided in Attachments III through XII. If an ROP provided by the configuration generator model is beyond the ROA, either additional benchmark experiments to encompass the ROP or applicable penalties (either Δk_{EROA} or Δk_{ISO} , or both) will need to be applied to the lower-bound tolerance limit in establishing the CL. The criticality potential is determined by the final comparison of a configuration's k_{eff} with the applicable CL.

Table 5. Criticality Acceptance Criteria for Experiment Subsets

Waste Form	Subset	Trend Parameter	Criticality Acceptance Criterion
PWR and BWR SNF	Intact Moderated (CRCs)	Core Average Burnup (BU)	$k_s + \Delta k_s < -0.0003 \times BU + 0.9866$ ($0 < BU < 33$ GWd/MTU)
	Intact Moderated (LCEs)	Pin Pitch (P)	$k_s + \Delta k_s < 7.0175E-03 \times P + 0.9677$ ($1.32 \text{ cm} \leq P \leq 1.89 \text{ cm}$); $k_s + \Delta k_s < 0.982$ ($1.89 \text{ cm} < P \leq 2.64 \text{ cm}$)
	Degraded Moderated (UO ₂ Solutions)	None	$k_s + \Delta k_s < 0.952$
	Degraded Moderated (Plutonium Solutions)	(AENCF)	$k_s + \Delta k_s < 0.980$ ($2.46E-03 \text{ MeV} \leq \text{AENCF} \leq 5.96E-02 \text{ MeV}$)
LWBR SNF	Intact Moderated	None	$k_s + \Delta k_s < 0.9751$
	Degraded Moderated		$k_s + \Delta k_s < 0.9748$
Enrico Fermi SNF	Intact Moderated	None	$k_s + \Delta k_s < 0.9751$
	Intact Nonmoderated	None	$k_s + \Delta k_s < 0.9872$
	Degraded Moderated	None	$k_s + \Delta k_s < 0.9659$
N-Reactor SNF	Intact Moderated	AENCF	$k_s + \Delta k_s < 0.0765 \times \text{AENCF} + 0.9434$ ($0 < \text{AENCF} < 0.175 \text{ MeV}$) $k_s + \Delta k_s < 0.9568$ ($\text{AENCF} > 0.175 \text{ MeV}$)
	Degraded Moderated	None	$k_s + \Delta k_s < 0.9748$
FFTF SNF	Intact Moderated	None	$k_s + \Delta k_s < 0.9786$
Melt and Dilute Ingots	Degraded Moderated	None	$k_s + \Delta k_s < 0.9659$
TRIGA SNF	Moderated Degraded	None	$k_s + \Delta k_s < 0.9796$
Fort St. Vrain SNF	Intact Moderated	AENCF	$k_s + \Delta k_s < 0.9575$ ($0 < \text{AENCF} < 0.386$) $k_s + \Delta k_s < -0.0226 \times \text{AENCF} + 0.9674$ ($0.386 < \text{AENCF} < 0.8015 \text{ MeV}$)
	Degraded Moderated	AENCF	$k_s + \Delta k_s < 0.9608$ ($0 < \text{AENCF} < 0.4625$) $k_s + \Delta k_s < -0.0183 \times \text{AENCF} + 0.9687$ ($0.4625 < \text{AENCF} < 0.8015 \text{ MeV}$)
Shippingport PWR SNF	Intact Moderated	AENCF	$k_s + \Delta k_s < 0.969$ ($0 < \text{AENCF} < 0.0278$) $k_s + \Delta k_s < -0.2336 \times \text{AENCF} + 0.9755$ ($0.0278 < \text{AENCF} < 0.0922 \text{ MeV}$)
LEU External	Homogeneous (Solution)	None	$k_s + \Delta k_s < 0.9842$
IEU External	Homogeneous (Solution)	AENCF	$k_s + \Delta k_s < 0.97841$ ($0 < \text{AENCF} < 0.1518 \text{ MeV}$) $k_s + \Delta k_s < -1.9322e-02 \times \text{AENCF} + 0.981339$ ($0.1518 \leq \text{AENCF} < 0.482 \text{ MeV}$)
HEU External	Homogeneous (Solution)	None	$k_s + \Delta k_s < 0.970611$ ($0 < \text{AENCF} < 0.247 \text{ MeV}$) $k_s + \Delta k_s < -1.7411e-02 \times \text{AENCF} + 0.97491$ ($0.247 \leq \text{AENCF} < 0.902 \text{ MeV}$)
²³³ U External	Homogeneous (Solution)	None	$k_s + \Delta k_s < 0.9748$
Mixture of U and Pu External	Homogeneous (Solution)	None	$k_s + \Delta k_s < 0.9644$

NOTES: AENCF = average energy of a neutron causing fission, CRCs = commercial reactor critical, BWR = boiling water reactor, FFTF = Fast flux Test Facility, LCEs = laboratory critical experiments, LWBR = light water breeder reactor, PWR = pressurized water reactor, SNF = spent nuclear fuel, TRIGA = Training Research Isotopes General Atomic LEU = Low Enriched Uranium, IEU = Intermediate Enriched Uranium, HEU = Highly Enriched Uranium, P = Pitch, BU = Burnup.

8. CONCLUSIONS

This analysis documents the criticality potential evaluation process together with a number of representative analyses for a variety of LWR and DOE-EM SNF fuel types. The analyses use current data for pressurized and boiling water reactor and DOE-owned SNF and provides results that may be updated as additional data becomes available. The computational method discussed in Section 6 illustrates how criticality potential for configurations of fissionable materials is determined.

The MCNP code was selected to perform the Monte Carlo method along with the material cross section data identified in Tables 1 and 2 as implemented by MCNP for representing neutron transport. Sets of benchmark experiments were presented to cover the range of various waste form/waste package and external configuration classes in Attachments III through XII. The major parameters covered by the benchmark experiments were burnup (where applicable), initial enrichment, spectrum, and geometry. Example criticality benchmark experiment trending parameter analyses were performed and results presented in Attachment III. The selected benchmark experiments were separated into subset applicability from which LBTL were statistically derived, and a specified ROA was provided. Criticality potential criteria were established for the experiment subsets over the given ROA in Table 5.

Three open items (13, 15, and 17) from *Safety Evaluation Report for Disposal Criticality Analysis Methodology Topical Report, Revision 0* (Reamer 2000) are addressed in analysis. Open Items 13, 15 and 17 are addressed in Section 6.3. Uncertainties based on Δk_{EROA} and Δk_{ISO} are accounted for in the critical limit calculation. Material and fabrication tolerances and uncertainties due to geometric or material representations used in the computational method are obviated by using bounding representations. The procedures defined in ANSI/ANS-8.1-1998, C4(a) and C4(b) are applied for extending the range of applicability.

9. INPUTS AND REFERENCES

9.1 DOCUMENTS CITED

Baldwin, M.N.; Hoovler, G.S.; Eng, R.L.; and Welfare, F.G. 1979. *Critical Experiments Supporting Close Proximity Water Storage of Power Reactor Fuel*. BAW-1484-7.

Lynchburg, Virginia: Babcock & Wilcox. TIC: 245055.

Bierman, S.R. 1990. *Criticality Experiments with Neutron Flux Traps Containing Voids*.

PNL-7167. Richland, Washington: Pacific Northwest Laboratory.

ACC: HQX.19900601.0051.

Bierman, S.R. and Clayton, E.D. 1981. *Criticality Experiments with Subcritical Clusters of 2.35 Wt% and 4.31 Wt% 235U Enriched UO₂ Rods in Water with Steel Reflecting Walls*.

NUREG/CR-1784. Washington, D.C.: U.S. Nuclear Regulatory Commission. TIC: 232871.

Bierman, S.R.; Clayton, E.D.; and Durst, B.M. 1977. *Critical Separation Between Subcritical Clusters of 2.35 Wt% 235U Enriched UO₂ Rods in Water with Fixed Neutron Poisons*.

PNL-2438. Richland, Washington: Pacific Northwest Laboratory. TIC: 223644.

Bierman, S.R.; Durst, B.M.; and Clayton, E.D. 1981. *Criticality Experiments with Subcritical Clusters of 2.35 Wt% and 4.31 Wt% 235U Enriched UO₂ Rods in Water with Uranium or Lead Reflecting Walls; Undermoderated Water-to-Fuel Volume Ratio of 1.6*. NUREG/CR-0796. Volume 2. Washington, D.C.: U.S. Nuclear Regulatory Commission. TIC: 232754.

Bierman, S.R.; Murphy, E.S.; Clayton, E.D.; and Keay, R.T. 1984. *Criticality Experiments with Low Enriched UO₂ Fuel Rods in Water Containing Dissolved Gadolinium*. PNL-4976. Richland, Washington: Pacific Northwest Laboratory. TIC: 222973.

Briesmeister, J.F., ed. 1997. *MCNP-A General Monte Carlo N-Particle Transport Code*. LA-12625-M, Version 4B. Los Alamos, New Mexico: Los Alamos National Laboratory. ACC: MOL.19980624.0328.

BSC (Bechtel SAIC Company, LLC) 2001a. *Evaluation of Codisposal Viability for Melt and Dilute DOE EM-Owned Fuel*. TDR-EDC-NU-000006 REV 00. Las Vegas, Nevada: Bechtel SAIC Company. ACC: MOL.20010809.0070.

BSC 2001b. *Evaluation of Codisposal Viability for Th/U Carbide (Fort Saint Vrain HTGR) DOE EM-Owned Fuel*. TDR-EDC-NU-000007 REV 00. Las Vegas, Nevada: Bechtel SAIC Company. ACC: MOL.20011017.0092.

BSC 2001c. *Software Definition Report for CLReg V1.0*. 10528-SDR-1.0-00. Las Vegas, Nevada: Bechtel SAIC Company. ACC: MOL.20020709.0403.

BSC 2002. *Benchmark and Critical Limit Calculation for DOE SNF*. CAL-EDC-NU-000008 REV 00. Las Vegas, Nevada: Bechtel SAIC Company. ACC: MOL.20020416.0053.

BSC 2003a. *Configuration Generator Model for In-Package Criticality*. MDL-EBS-NU-000001 REV 01 ICN 01. Las Vegas, Nevada: Bechtel SAIC Company. ACC: DOC.20030908.0004.

BSC 2003b. *Analysis of Critical Benchmark Experiments and Critical Limit Calculation for DOE SNF*. CAL-DSD-NU-000003 REV 00A. Las Vegas, Nevada: Bechtel SAIC Company. ACC: DOC.20030724.002.

BSC 2004a. *Technical Work Plan for: Criticality Department Work Packages ACRM01 and NSN002*. TWP-EBS-MD-000014 REV 02. Las Vegas, Nevada: Bechtel SAIC Company. ACC: DOC.20040408.0003.

BSC 2004b. *Isotopic Model for Commercial SNF Burnup Credit*. CAL-DSU-NU-000007 REV 00A. Las Vegas, Nevada: Bechtel SAIC Company. ACC: DOC.20040818.0001.

CRWMS M&O (Civilian Radioactive Waste Management System Management and Operating Contractor) 1998a. *Software Qualification Report for MCNP Version 4B2, A General Monte Carlo N-Particle Transport Code*. CSCI: 30033 V4B2LV. DI: 30033-2003, Rev. 01. Las Vegas, Nevada: CRWMS M&O. ACC: MOL.19980622.0637.

CRWMS M&O 1998b. *Selection of MCNP Cross Section Libraries*. B00000000-01717-5705-00099 REV 00. Las Vegas, Nevada: CRWMS M&O. ACC: MOL.19980722.0042.

CRWMS M&O 1998c. *Principal Isotope Selection Report*. B00000000-01717-5705-00104 REV 00. Las Vegas, Nevada: CRWMS M&O. ACC: MOL.19980827.0187.

CRWMS M&O 1998d. *Summary Report of Commercial Reactor Critical Analyses Performed for the Disposal Criticality Analysis Methodology*. B00000000-01717-5705-00075 REV 01. Las Vegas, Nevada: CRWMS M&O. ACC: MOL.19980825.0001.

CRWMS M&O 1998e. *Summary Report of Commercial Reactor Criticality Data for McGuire Unit 1*. B00000000-01717-5705-00063 REV 01. Las Vegas, Nevada: CRWMS M&O. ACC: MOL.19980622.0079.

CRWMS M&O 1998f. *Summary Report of Commercial Reactor Criticality Data for Sequoyah Unit 2*. B00000000-01717-5705-00064 REV 01. Las Vegas, Nevada: CRWMS M&O. ACC: MOL.19980716.0015.

CRWMS M&O 1999a. *Summary Report of Laboratory Critical Experiment Analyses Performed for the Disposal Criticality Analysis Methodology*. B00000000-01717-5705-00076 REV 02. Las Vegas, Nevada: CRWMS M&O. ACC: MOL.19990920.0167.

CRWMS M&O 1999b. *Range of Neutronic Parameters Calculation File*. B00000000-01717-0210-00028 REV 01. Las Vegas, Nevada: CRWMS M&O. ACC: MOL.19990923.0231.

CRWMS M&O 1999c. *Waste Package, LCE, CRC, and Radiochemical Assay Comparison Evaluation*. B00000000-01717-0210-00107 REV 00. Las Vegas, Nevada: CRWMS M&O. ACC: MOL.19990812.0351.

CRWMS M&O 1999d. *Laboratory Critical Experiment Reactivity Calculations*. B00000000-01717-0210-00018 REV 01. Las Vegas, Nevada: CRWMS M&O. ACC: MOL.19990526.0294.

CRWMS M&O 1999e. *LCE for Research Reactor Benchmark Calculations*. B00000000-01717-0210-00034 REV 00. Las Vegas, Nevada: CRWMS M&O. ACC: MOL.19990329.0394.

CRWMS M&O 1999f. *Evaluation of Codisposal Viability for MOX (FFTF) DOE-Owned Fuel*. BBA000000-01717-5705-00023 REV 00. Las Vegas, Nevada: CRWMS M&O. ACC: MOL.19991014.0235.

CRWMS M&O 2000a. *Evaluation of Codisposal Viability for HEU Oxide (Shippingport PWR) DOE EM-Owned Fuel*. TDR-EDC-NU-000003 REV 00. Las Vegas, Nevada: CRWMS M&O. ACC: MOL.20000227.0240.

CRWMS M&O 2000b. *Evaluation of Codisposal Viability for UZrH (TRIGA) DOE EM-Owned Fuel*. TDR-EDC-NU-000001 REV 00. Las Vegas, Nevada: CRWMS M&O. ACC: MOL.20000207.0689.

CRWMS M&O 2000c. *Evaluation of Codisposal Viability for U-Zr/U-Mo Alloy (Enrico Fermi) DOE EM-Owned Fuel*. TDR-EDC-NU-000002 REV 00. Las Vegas, Nevada: CRWMS M&O. ACC: MOL.20000815.0317.

CRWMS M&O 2000d. *Users Manual for SCALE-4.4A*. 10129-UM-4.4A-00. Las Vegas, Nevada: CRWMS M&O. ACC: MOL.20001130.0136; MOL.20010822.0084; MOL.20010822.0085; MOL.20010822.0086; MOL.20010822.0087.

CRWMS M&O 2000e. *Evaluation of Codisposal Viability for Th/U Oxide (Shippingport LWBR) DOE EM-Owned Fuel*. TDR-EDC-NU-000005 REV 00. Las Vegas, Nevada: CRWMS M&O. ACC: MOL.20001023.0055.

CRWMS M&O 2001. *Evaluation of Codisposal Viability for U-Metal (N Reactor) DOE EM-Owned Fuel*. TDR-EDC-NU-000004 REV 00. Las Vegas, Nevada: CRWMS M&O. ACC: MOL.20010314.0004.

D'Agostino, R.B. and Stephens, M.A., eds. 1986. *Goodness-Of-Fit Techniques*. Statistics, Textbooks and Monographs Volume 68. New York, New York: Marcel Dekker. TIC: 253256.

Dean, J.C. and Tayloe, R.W., Jr. 2001. *Guide for Validation of Nuclear Criticality Safety Computational Methodology*. NUREG/CR-6698. Washington, D.C.: U.S. Nuclear Regulatory Commission. TIC: 254004.

DOE (U.S. Department of Energy) 2002. *DOE Spent Nuclear Fuel Information in Support of TSPA-SR*. DOE/SNF/REP-047, Rev. 2. Idaho Falls, Idaho: U.S. Department of Energy, Idaho Operations Office. TIC: 252089.

Duderstadt, J.J. and Hamilton L.J. 1976. *Nuclear Reactor Analysis*. New York, New York: John Wiley & Sons. TIC: 245454.

Durst, B.M.; Bierman, S.R.; and Clayton, E.D. 1982. *Critical Experiments with 4.31 Wt% ²³⁵U Enriched UO₂ Rods in Highly Borated Water Lattices*. NUREG/CR-2709. Washington, D.C.: U.S. Nuclear Regulatory Commission. TIC: 232755.

Harwell, J. W. 2003. *Commercial Reactor Reactivity Analysis for Grand Gulf, Unit 1*. 32-5029393-00. Lynchburg, Virginia: Framatome ANP. ACC: DOC.20040109.0003.

Lichtenwalter, J.J.; Bowman, S.M.; DeHart, M.D.; and Hopper, C.M. 1997. *Criticality Benchmark Guide for Light-Water-Reactor Fuel in Transportation and Storage Packages*. NUREG/CR-6361. Washington, D.C.: U.S. Nuclear Regulatory Commission. TIC: 233099.

Massie, H. 2003. *Critical Limit Development for PWR and BWR SNF Waste Package*. 32-5037984-01. Lynchburg, Virginia: Framatome ANP. ACC: DOC.20040709.0001.

Miyoshi, Y.; Umamo, T.; Tonoike, K.; Izawa, N.; Sugikawa, S.; and Okazaki, S. 1997. "Critical Experiments on 10% Enriched Uranyl Nitrate Solution Using a 60-cm-Diameter Cylindrical Core." *Nuclear Technology*, 118, (1), 69-82. La Grange Park, Illinois: American Nuclear Society. TIC: 244153.

Moscalu, D.R. 2004. *Analysis of Critical Benchmark Experiments for Configurations External to WP*. 32-5045840-00. Las Vegas, Nevada: Areva. ACC: DOC.20040701.0003.

Natrella, M.G. 1963. *Experimental Statistics*. National Bureau of Standards Handbook 91. Washington, D.C.: U.S. Department of Commerce, National Bureau of Standards. TIC: 245911.

NEA (Nuclear Energy Agency) 1998. *International Handbook of Evaluated Criticality Safety Benchmark Experiments*. NEA/NSC/DOC(95)03. Paris, France: Nuclear Energy Agency. TIC: 243013.

NEA 2001. *International Handbook of Evaluated Criticality Safety Benchmark Experiments*. 2001 Edition. NEA/NSC/DOC(95)03. Paris, France: Nuclear Energy Agency, Organization for Economic Co-operation and Development. TIC: 251945.

NEA (Nuclear Energy Agency) 2003. *International Handbook of Evaluated Criticality Safety Benchmark Experiments*. 2003 Edition. NEA/NSC/DOC(95)03. [Paris, France]: Nuclear Energy Agency, Organization for Economic Co-Operation and Development. TIC: 256092.

Newman, L.W. 1984. *Urania-Gadolinia: Nuclear Model Development and Critical Experiment Benchmark*. DOE/ET/34212-41. Lynchburg, Virginia: Babcock & Wilcox. TIC: 233536.

ORNL (Oak Ridge National Laboratory) 1995. *Analysis of Fresh Fuel Critical Experiments Appropriate for Burnup Credit Validation*. ORNL/TM-12959. Oak Ridge, Tennessee: Oak Ridge National Laboratory. ACC: HQO.19951023.0010.

Punatar, M.K. 2001a. *Summary Report of Commercial Reactor Criticality Data for Crystal River Unit 3*. TDR-UDC-NU-000001 REV 02. Las Vegas, Nevada: Bechtel SAIC Company. ACC: MOL.20010702.0087.

Punatar, M.K. 2001b. *Summary Report of Commercial Reactor Criticality Data for Grand Gulf Unit 1*. TDR-UDC-NU-000002 REV 00. Las Vegas, Nevada: Bechtel SAIC Company. ACC: MOL.20011008.0008.

Putman, V.L. 2003. *Criticality Safety Code Validation with LWBR's SB Cores*. INEEL/EXT-02-00304. Idaho Falls, Idaho: Idaho National Engineering and Environmental Laboratory. TIC: 253902.

Reamer, C.W. 2000. "Safety Evaluation Report for Disposal Criticality Analysis Methodology Topical Report, Revision 0." Letter from C.W. Reamer (NRC) to S.J. Brocoum (DOE/YMSCO), June 26, 2000, with enclosure. ACC: MOL.20000919.0157.

Scheaffer, R.L. and McClave, J.T. 1990. *Probability and Statistics for Engineers*. 3rd Edition. Boston, Massachusetts: PWS-Kent. TIC: 249631.

Taylor, E.G. 1965. *Saxton Plutonium Program, Critical Experiments for the Saxton Partial Plutonium Core*. EURAEC-1493, WCAP-3385-54. Pittsburgh, Pennsylvania: Westinghouse Electric Corporation, Atomic Power Division. TIC: 223286.

Walpole, R.E.; Myers, R.H.; and Myers, S.L. 1998. *Probability and Statistics for Engineers and Scientists*. 6th Edition. Upper Saddle River, New Jersey: Prentice Hall. TIC: 242020.

Wimmer, L.B. 2001. *Summary Report of Commercial Reactor Criticality Data for Three Mile Island Unit 1*. TDR-UDC-NU-000004 REV 01. Las Vegas, Nevada: Bechtel SAIC Company. ACC: MOL.20010921.0047.

Wittekind, W.D. 1992. *K Basin Criticality Evaluation for Irradiated Fuel Canisters in Sludge*. WHC-SD-NR-CSER-001, Rev. 0. Richland, Washington: Westinghouse Hanford. TIC: 240971.

YMP (Yucca Mountain Site Characterization Project) 2003. *Disposal Criticality Analysis Methodology Topical Report*. YMP/TR-004Q, Rev. 02. Las Vegas, Nevada: Yucca Mountain Site Characterization Office. ACC: DOC.20031110.0005.

9.2 CODES, STANDARDS, REGULATIONS, AND PROCEDURES

ANSI/ANS-8.1-1998. *Nuclear Criticality Safety in Operations with Fissionable Material Outside Reactors*. La Grange Park, Illinois: American Nuclear Society. TIC: 242363.

ANSI/ANS-8.17-1984. *Criticality Safety Criteria for the Handling, Storage, and Transportation of LWR Fuel Outside Reactors*. La Grange Park, Illinois: American Nuclear Society. TIC: 231625.

9.3 SOFTWARE CODES

Software Code: CLREG. V1.0. PC - Windows 2000. 10528-1.0-01.

Software Code: MCNP. V4B2LV. HP, HP/UX 9.07 and 10.20; PC, Windows 95; Sun, Solaris 2.6. 30033 V4B2LV.

10. ATTACHMENTS

The description of the attachments is provided in Table 6.

Table 6. Attachment Listing

Attachment	Description
I	Listing of LUTB and MCNP Spectral Characteristic Input and Output Files Contained in Attachment II
II	Compact Disc
III	LBTL Calculation and ROA Determination for LWR SNF
IV	LBTL Calculation and ROA Determination for Shippingport LWBR
V	LBTL Calculation and ROA Determination for Enrico Fermi
VI	LBTL Calculation and ROA Determination for N-Reactor
VII	LBTL Calculation and ROA Determination for FFTF
VIII	LBTL Calculation and ROA Determination for Melt and Dilute Ingots
IX	LBTL Calculation and ROA Determination for TRIGA SNF
X	LBTL Calculation and ROA Determination for Fort St. Vrain SNF
XI	LBTL Calculation and ROA Determination for Shippingport PWR
XII	LBTL Calculation and ROA Determination for Configurations External to the Waste Package

INTENTIONALLY LEFT BLANK

ATTACHMENT I

**LISTING OF LUTB AND MCNP SPECTRAL CHARACTERISTIC INPUT AND
OUTPUT FILES CONTAINED IN ATTACHMENT II**

ATTACHMENT I

LISTING OF LUTB AND MCNP SPECTRAL CHARACTERISTIC INPUT AND OUTPUT FILES CONTAINED IN ATTACHMENT II

This attachment contains a listing and description of the zip file contained on the attachment CD of this model report. The zip archive was created using WinZip 8.1. The zip file attributes are:

<u>Archive File Name</u>	<u>File Size (bytes)</u>	<u>FileDate</u>	<u>File Time</u>
CM-R00A.zip	8,086,179	09/09/2004	10:16 AM

There are 31 total files contained in a unique directory structure. Upon file extraction, the following directory and files structure will be found:

<u>Zip File</u>	<u>Directories</u>	<u>Subdirectories</u>	<u>Files</u>
CM-R00A.zip	CLREG Files		CLREG input and output files for Attachment III, lower bound tolerance limit calculations
		PWR	MCNP input and output files for Attachment III

INTENTIONALLY LEFT BLANK

ATTACHMENT II
COMPACT DISC

ATTACHMENT II
COMPACT DISC

This CD contains a listing of LUTB and MCNP spectral characteristic input and output files.

INTENTIONALLY LEFT BLANK

ATTACHMENT III
LBTL CALCULATION AND ROA DETERMINATION FOR LWR SNF

ATTACHMENT III

LBTL CALCULATION AND ROA DETERMINATION FOR LWR SNF

III.1 INTRODUCTION

This attachment presents the calculations of the lower-bound tolerance limit (LBTL) and the determination of range of applicability (ROA) for benchmarks that could potentially be applicable to waste package configurations containing pressurized water reactor (PWR) and boiling water reactor (BWR) spent nuclear fuel (SNF). A listing of corroborating and supporting data, models, or information used for the calculation is provided in Table III-1.

Table III-1. Supporting Information and Sources

Description	Source
Criticality benchmark experiments	Durst et al. 1982; Miyoshi et al. 1997; Newman 1984; NEA 1998; ORNL 1995; Taylor 1965; Wittekind 1992; Bierman et al. 1984; Bierman et al. 1981; Bierman et al. 1977; Bierman and Clayton 1981; Bierman 1990; Baldwin et al. 1979; CRWMS M&O 1999a
Measured critical systems	CRWMS M&O 1998d
Trending parameters	CRWMS M&O 1999b, CRWMS M&O 1999c CRWMS M&O 1999d, CRWMS M&O 1999e
Fuel characteristics	Punatar 2001a, Punatar 2001b , Wimmer 2001, CRWMS M&O 1998f, CRWMS M&O 1998e
Benchmark selection guidance	Lichtenwater et al. 1997

III.2 SELECTION OF CRITICALITY BENCHMARK EXPERIMENTS

The calculation method used to establish the criticality potential for a waste package must be benchmarked against measured data (criticality benchmark experiments). The criticality benchmark experiments must be applicable to the package under consideration. This section provides brief descriptions of the criticality benchmark experiments selected for benchmarking the computational method for commercial light water reactor (LWR) SNF.

Two types of experimental data are used: laboratory critical experiments (LCEs) and commercial reactor critical (CRCs). Various parameters are trended with the k_{eff} values from the LCEs and the CRCs. These trends are used to establish biases and uncertainties of the criticality computational method.

Guidelines for experiment selection come from Lichtenwalter et al. (1997), which states, "There are three fundamental parameters that should be considered in the selection of suitable experiments for use in the evaluation of transportation and storage package designs. They are as follows: (1) geometry of construction; (2) materials of construction (including fissionable material); and (3) the inherent neutron energy spectrum affecting the fissionable material."

With these fundamental parameters in mind, CRCs fulfill each to a degree. The geometry of the waste package configuration and the CRC configuration are similar. Both approximate cylindrical systems and the fuel assembly geometric arrangement is identical when it comes down to lattice, pin pitch, structural materials, cladding, and guide tube positions. Differences arise in the assembly-to-assembly pitch, interstitial materials between assemblies, and moderator

and fuel cross section temperature differences. Also, due to the size differences between a reactor pressure vessel and a waste package, a CRC has less neutron leakage than in a waste package.

The fuel assembly material compositions used in the CRC representations are sufficiently similar to the fuel assemblies used in the waste package representations. Both systems contain burned fuel isotopics. Since the waste package is designed to remain subcritical, the materials between assemblies (i.e., borated steel plates in waste package) are different between the waste package and the CRC. These materials cause a reduction in the neutron multiplication factor for the waste package environment.

The reflector and moderator materials are similar for both the CRC and the waste package. PWR CRCs contain borated moderator, which is used for additional neutron population control. The moderator-to-fuel ratio is greater in the waste package due to the presence of full-density water. The temperature in the CRC environment is greater than in the waste package environment, which has an effect on Doppler broadening of the resonances and an increase in resonance absorption. Doppler broadening refers to a change in cross section resulting from thermal motion of nuclei in a target material. The end result of these minor differences in the moderator and reflector material compositions produces a small difference in the hydrogen-to-fissile atom (H/X) ratio between the two systems and causes a slight spectral shift.

The CRCs represent intact commercial SNF in known critical configurations. The k_{eff} values obtained from analysis of the CRCs do not include any bias from SNF isotopic concentrations of the individual isotopes. Isotopic bias will be addressed as part of the isotopic model (BSC 2004b) and incorporated in the critical limit (CL).

LCEs benchmark the criticality computational method for a range of fissionable materials, enrichments of fissile isotopes, moderator materials, and absorber materials. The homogeneous LCEs are used to calculate bias and uncertainties for degraded waste forms and configurations where the fuel assembly geometry has been lost.

Criticality benchmark experiments were selected from a group of experiments that include LCEs and CRCs. Numerous references were used along with descriptions of pertinent information regarding each of the experiments. LCEs are used to benchmark the criticality computational method for un-irradiated, fresh fuel in various configurations representative of the range of potential configurations anticipated in the repository. CRCs are used to benchmark the criticality computational method for irradiated, burned SNF in intact lattice geometry. The criticality benchmark experiments that were selected provide a range of enrichments, lattice geometries, and fuel rod spacings typical of commercial LWR fuel in an intact configuration. The LCEs also contain homogeneous solution criticality benchmark experiments that are representative of degraded waste form configurations. These criticality benchmark experiment configurations cover the span of potential configurations possible over time in the repository. The CRCs provide a range of fuel enrichments in actual reactor geometries and conditions. CRCs are described in Section III.2.1 and LCEs are described in Section III.2.2. The criticality benchmark experiment sources are used for descriptions of experiment parameters. The rationale for their use in this attachment for commercial LWR SNF is provided in Table III-2.

The following sources were used to demonstrate applicability as part of the benchmarking process. They were used to take previously evaluated benchmark experiment MCNP input cases

and add a tally output edit that illustrates the neutron spectral characteristics. The results of these tallies are illustrated in Section III.3.5. The MCNP input and output files for the tally calculations are documented in Attachment I (Attachment I provides a listing of the files contained on compact disc [Attachment II]) such that an independent repetition of the software use could be performed.

- *Waste Package, LCE, CRC, and Radiochemical Assay Comparison Evaluation* (CRWMS M&O 1999c) (cases crc2 and wp2 referred to as crc and wp)
- *Laboratory Critical Experiment Reactivity Calculations* (CRWMS M&O 1999d) (case exp22e5 referred to as exp22)
- *LCE for Research Reactor Benchmark Calculations* (CRWMS M&O 1999e) (cases ssr48.i and ssr53.i referred to as ssr48 and ssr53).

Table III-2. Rationale for Use of Experiment Sources

Source	Rationale for Use
Critical Experiments with 4.31 wt. % ²³⁵ U-Enriched UO ₂ Rods in Highly Borated Water Lattices (Durst et al. 1982)	Applicable to LWR SNF in waste package configurations
Critical Experiments on 10% Enriched Uranyl Nitrate Solution Using a 60-cm-Diameter Cylindrical Core (Miyoshi et al. 1997)	Applicable to LWR SNF in waste package configurations
Urania-Gadolinia: Nuclear Model Development and Critical Experiment Benchmark (Newman 1984)	Applicable to LWR SNF in waste package configurations
International Handbook of Evaluated Criticality Safety Benchmark Experiments (NEA 1998)	Applicable to LWR SNF in waste package configurations
Analysis of Fresh Fuel Critical Experiments Appropriate for Burnup Credit Validation (ORNL 1995)	Applicable to LWR SNF in waste package configurations
Saxton Plutonium Program, Critical Experiments for the Saxton Partial Plutonium Core (Taylor 1965)	Applicable to LWR SNF in waste package configurations
K Basin Criticality Evaluation for Irradiated Fuel Canisters in Sludge (Wittekind 1992)	Applicable to LWR SNF in waste package configurations
Criticality Experiments with Low Enriched UO ₂ Fuel Rods in Water Containing Dissolved Gadolinium (Bierman et al. 1984)	Applicable to LWR SNF in waste package configurations
Criticality Experiments with Subcritical Clusters of 2.35 wt. % and 4.31 wt. % ²³⁵ U-Enriched UO ₂ Rods in Water with Uranium or Lead Reflecting Walls; Undermoderated Water-to-Fuel Volume Ratio of 1.6 (Bierman et al. 1981)	Applicable to LWR SNF in waste package configurations
Critical Separation Between Subcritical Clusters of 2.35 wt. % ²³⁵ U-Enriched UO ₂ Rods in Water with Fixed Neutron Poisons (Bierman et al. 1977)	Applicable to LWR SNF in waste package configurations
Criticality Experiments with Subcritical Clusters of 2.35 wt. % and 4.31 wt. % ²³⁵ U-Enriched UO ₂ Rods in Water with Steel Reflecting Walls (Bierman and Clayton 1981)	Applicable to LWR SNF in waste package configurations
Criticality Experiments with Neutron Flux Traps Containing Voids (Bierman 1990)	Applicable to LWR SNF in waste package configurations
Critical Experiments Supporting Close Proximity Water Storage of Power Reactor Fuel (Baldwin et al. 1979)	Applicable to LWR SNF in waste package configurations
Summary Report of Commercial Reactor Critical Analyses Performed for the Disposal Criticality Analysis Methodology (CRWMS M&O 1998d)	Monitored PWR critical systems
Summary Report of Laboratory Critical Experiment Analyses Performed for the Disposal Criticality Analysis Methodology (CRWMS M&O 1999a)	Applicable to LWR SNF in waste package configurations

III.2.1 CRC Experiments

The CRC k_{eff} values were calculated using the best-estimate isotope set corresponding to those listed in Table 4. Each of the CRC benchmark cases used water scattering kernels corresponding to a temperature of 500 K.

III.2.1.1 Crystal River Unit 3

The Crystal River Unit 3 plant operated by Progress Energy is a Babcock & Wilcox (B&W) PWR with 177 fuel assemblies. The fuel assemblies are the B&W 15×15 design type. A total of 33 CRC experiments have been evaluated for Crystal River Unit 3 where the core thermal power varied between 2452 MW and 2544 MW (Punatar 2001a, pp. 2-5 and 4-238 to 4-246).

Table III-3 provides some general information about the Crystal River Unit 3 CRC experiments. The information includes the statepoint cycle length in effective full power days (EFPD,) the core average burnup, the initial weight percent enrichments of the fuel batches in the core during the CRC experiment (fresh fuel is identified by “[]” around the enrichment values), the down time in days since the core was last at power before restarting, along with the calculated k_{eff} values, sigma (σ), and average energy of a neutron causing fission (AENCF). The pin pitch for the assemblies from this reactor was 1.44272 cm, which results in a moderator-to-fuel volume ratio of 1.7 (Punatar 2001a, p. 2-3).

Table III-3. General Crystal River Unit 3 CRC Statepoint Information

Case	Cycle Length to Statepoint (EFPD, Cycle) ^a	Initial Enrichments (wt. % ²³⁵ U) ^a	Core Average Burnup (GWd/MTU) ^b	Downtime (d) ^a	k_{eff} ^a	σ ^a	AENCF ^c (MeV)	CC ^d
CR1	0.0 (Cy 1A)	[1.93, 2.54, 2.83]	0.00	0.0	0.99601	0.00043	0.2344	3a, 3b, 3c, 3d
CR2	268.8 (Cy 1B)	1.93, 2.54, 2.83, 2.00	8.09	195.3	0.99285	0.0004	0.2504	
CR3	411.0 (Cy 1B)	1.93, 2.54, 2.83, 2.00	12.34	14.8	0.99502	0.00046	0.2518	
CR4	0.0 (Cy 2)	2.54, [2.64], 2.83	8.67	97.0	0.99282	0.00044	0.2498	
CR5	0.0 (Cy 3)	2.54, [2.62], 2.64, 2.83	7.50	164.0	0.99408	0.00045	0.2489	
CR6	168.5 (Cy 3)	2.54, 2.62, 2.64, 2.83	12.54	16.8	0.99304	0.00045	0.2536	
CR7	250.0 (Cy 3)	2.54, 2.62, 2.64, 2.83	14.98	12.3	0.99073	0.00045	0.2547	
CR8	0.0 (Cy 4)	2.62, [2.62], 2.64, [2.95]	6.92	73.0	0.99134	0.00047	0.2499	
CR9	228.1 (Cy 4)	2.62, 2.64, 2.95	14.00	15.2	0.99152	0.00046	0.2576	
CR10	253.0 (Cy 4)	2.62, 2.64, 2.95	14.77	24.0	0.99603	0.00047	0.2568	

Table III-3. General Crystal River Unit 3 CRC Statepoint Information (Continued)

Case	Cycle Length to Statepoint (EFPD, Cycle) ^a	Initial Enrichments (wt. % ²³⁵ U) ^a	Core Average Burnup (GWd/MTU) ^b	Downtime (d) ^a	k _{eff} ^a	σ ^a	AENCF ^c (MeV)	CC ^d
CR11	0.0 (Cy 5)	2.62, 2.64, 2.95, [2.95, 3.29]	7.08	127.0	0.99479	0.00047	0.2475	
CR12	388.5 (Cy 5)	2.62, 2.64, 2.95, 3.29	19.12	5.0	0.99805	0.00045	0.2605	
CR13	0.0 (Cy 6)	2.62, 2.64, 2.95, 3.29, [3.49]	12.01	163.0	0.99561	0.00043	0.2513	
CR14	96.0 (Cy 6)	2.62, 2.64, 2.95, 3.29, 3.49	14.99	168.9	0.99579	0.00047	0.2557	
CR15	400.0 (Cy 6)	2.62, 2.64, 2.95, 3.29, 3.49	24.41	10.4	0.99273	0.00044	0.2612	
CR16	0.0 (Cy 7)	2.54, 2.62, 2.64, 3.29, 3.49, [3.84]	10.02	113.0	0.99324	0.00052	0.2504	
CR17	260.3 (Cy 7)	2.54, 2.62, 2.64, 3.29, 3.49, 3.84	18.09	18.9	0.99083	0.00045	0.2583	
CR18	291.0 (Cy 7)	2.54, 2.62, 2.64, 3.29, 3.49, 3.84	19.04	39.5	0.99222	0.00049	0.2598	
CR19	319.0 (Cy 7)	2.54, 2.62, 2.64, 3.29, 3.49, 3.84	19.91	109.5	0.98993	0.00047	0.2587	
CR20	462.3 (Cy 7)	2.54, 2.62, 2.64, 3.29, 3.49, 3.84	24.35	2.2	0.99321	0.00042	0.2582	
CR21	479.0 (Cy 7)	2.54, 2.62, 2.64, 3.29, 3.49, 3.84	24.87	7.2	0.99247	0.00046	0.2616	3a, 3b, 3c, 3d
CR22	0.0 (Cy 8)	1.93, 2.62, 3.29, 3.49, 3.84, [3.94]	12.26	99.0	0.99039	0.00043	0.2532	
CR23	97.6 (Cy 8)	1.93, 2.62, 3.29, 3.49, 3.84, 3.94	15.27	15.5	0.99021	0.00046	0.2572	
CR24	139.8 (Cy 8)	1.93, 2.62, 3.29, 3.49, 3.84, 3.94	16.58	6.2	0.99063	0.00049	0.2582	
CR25	404.0 (Cy 8)	1.93, 2.62, 3.29, 3.49, 3.84, 3.94	24.74	44.4	0.99054	0.00042	0.2615	
CR26	409.6 (Cy 8)	1.93, 2.62, 3.29, 3.49, 3.84, 3.94	24.91	4.9	0.99067	0.00047	0.2610	
CR27	515.5 (Cy 8)	1.93, 2.62, 3.29, 3.49, 3.84, 3.94	28.19	7.6	0.98772	0.00044	0.2643	
CR28	0.0 (Cy 9)	1.93, 3.84, [3.90], 3.94	14.18	75.0	0.99208	0.00044	0.2546	
CR29	158.8 (Cy 9)	1.93, 3.84, 3.90, 3.94	19.10	2.1	0.99311	0.0005	0.2584	
CR30	219.0 (Cy 9)	1.93, 3.84, 3.90, 3.94	20.96	53.1	0.99078	0.00048	0.2597	
CR31	363.1 (Cy 9)	1.93, 3.84, 3.90, 3.94	25.42	1.6	0.98837	0.00048	0.2635	
CR32	0.0 (Cy 10)	3.84, 3.90, 3.94, [4.167]	15.24	55.0	0.99164	0.00052	0.2558	
CR33	573.7 (Cy 10)	3.84, 3.90, 3.94, 4.167	33.00	16.4	0.98725	0.00048	0.2660	

NOTES: ^a Values are from CRWMS M&O 1998d, pp. 40 and 41.

^b Simple average of statepoint assemblies nodal height weighted averages from Punatar 2001a, Sections 3 and 4.

^c Values are from CRWMS M&O 1999b, pp. 60, 61, and 64 to 66.

^d CC = configuration class applicability (IP-).

III.2.1.2 Three Mile Island Unit 1

The Three Mile Island Unit 1 plant operated by Exelon Nuclear Corporation is a B&W PWR with 177 fuel assemblies. The fuel assemblies are the B&W 15×15 design type. A total of three CRC experiments have been evaluated for Three Mile Island Unit 1 where the core thermal power was 2535 MW (Wimmer 2001, pp. 2-5 and 3-2).

Table III-4 provides some general information about the Three Mile Island Unit 1 CRC experiments. The information includes the statepoint cycle length in EFPD, the core average burnup, the initial weight percent enrichments of the fuel batches in the core during the CRC experiment (fresh fuel is identified by “[]” around the enrichment values), the down time in days since the core was last at power before restarting, along with the calculated k_{eff} values, sigma, and AENCF. The pin pitch for the assemblies from this reactor was 1.44272 cm, which results in a moderator-to-fuel volume ratio of 1.7 (Wimmer 2001, p. 2-3).

Table III-4. General Three Mile Island Unit 1 CRC Statepoint Information

Case	Cycle Length to Statepoint (EFPD, Cycle) ^a	Initial Enrichments (wt. % ²³⁵ U) ^a	Core Average Burnup (GWd/MTU) ^b	Downtime (d) ^a	k_{eff} ^a	σ ^a	AENCF ^c (MeV)	CC ^d
TMI1	0.0 (Cy 1)	[2.06, 2.75, 3.05]	0.00	0.0	1.00141	0.00042	0.2353	3a, 3b, 3c, 3d
TMI2	0.0 (Cy 5)	2.64, 2.85, [2.85]	10.33	2,420.0	0.99088	0.00046	0.2476	
TMI3	114.4 (Cy 5)	2.64, 2.85	13.87	32.2	0.99162	0.00048	0.2498	

NOTES: ^a Values are from CRWMS M&O 1998d, p. 41.

^b Simple average of statepoint assemblies nodal height weighted averages from Wimmer 2001, Sections 3 and 4.

^c Values are from CRWMS M&O 1999b, pp. 60, 61, and 64 to 66.

^d CC = configuration class applicability (IP-).

III.2.1.3 Sequoyah Unit 2

The Sequoyah Unit 2 plant operated by Tennessee Valley Authority Nuclear is a 1148 MWe Westinghouse PWR with 193 fuel assemblies. The fuel assemblies are the Westinghouse 17×17 design type. A total of three CRC experiments have been evaluated for Sequoyah Unit 2 (CRWMS M&O 1998d, p. 29).

Table III-5 provides some general information about the Sequoyah Unit 2 CRC experiments. The information includes the statepoint cycle length in EFPD, the core average burnup, the initial weight percent enrichments of the fuel batches in the core during the CRC experiment (fresh fuel is identified by “[]” around the enrichment values), the down time in days since the core was last at power before restarting, along with the calculated k_{eff} values, sigma, and AENCF. The pin pitch for the assemblies from this reactor was 1.25984 cm, which results in a moderator-to-fuel volume ratio of 1.6 (CRWMS M&O 1998f, p. 7).

Table III-5. General Sequoyah Unit 2 CRC Statepoint Information

Case	Cycle Length to Statepoint (EFPD, Cycle) ^a	Initial Enrichments (wt. % ²³⁵ U) ^a	Core Average Burnup (GWd/MTU) ^b	Downtime (d) ^a	k _{eff} ^a	σ ^a	AENCF ^c (MeV)	CC ^d
SQ1	0.0 (Cy 1)	[2.10, 2.60, 3.10]	0.00	0.0	0.99631	0.00043	0.2374	3a, 3b, 3c, 3d
SQ2	0.0 (Cy 3)	2.60, 3.10, 3.50, [3.60, 3.80]	11.11	81.0	0.99158	0.00044	0.2518	
SQ3	210.9 (Cy 3)	2.60, 3.10, 3.50, 3.60, 3.80	19.20	995.7	0.99180	0.00050	0.2555	

NOTES: ^a Values are from CRWMS M&O 1998d, p. 41.

^b Simple average of statepoint assemblies nodal height weighted averages from CRWMS M&O 1998f, Sections 3 and 4.

^c Values are from CRWMS M&O 1999b, pp. 60, 61, and 64 to 66.

^d CC = configuration class applicability (IP-).

III.2.1.4 McGuire Unit 1

The McGuire Unit 1 plant operated by Duke Power Company is a 1129 MWe Westinghouse PWR with 193 fuel assemblies. The fuel assemblies are the Westinghouse 17 × 17 design type. A total of six CRC experiments have been evaluated for McGuire Unit 1 (CRWMS M&O 1998d, p. 25).

Table III-6 provides some general information about the McGuire Unit 1 CRC experiments. The information includes the statepoint cycle length in EFPD, the core average burnup, the initial weight percent enrichments of the fuel batches in the core during the CRC experiment (fresh fuel is identified by “[]” around the enrichment values), the down time in days since the core was last at power before restarting, along with the calculated k_{eff} values, sigma, and AENCF. The pin pitch for the assemblies from this reactor was 1.25984 cm, which results in a moderator-to-fuel volume ratio between 1.7 and 1.9 (CRWMS M&O 1998e, p. 7).

Table III-6. General McGuire Unit 1 CRC Statepoint Information

Case	Cycle Length to Statepoint (EFPD, Cycle) ^a	Initial Enrichments (wt. % ²³⁵ U) ^a	Core Average Burnup (GWd/MTU) ^b	Downtime (d) ^a	k _{eff} ^a	σ ^a	AENCF ^c (MeV)	CC ^d
MG1	0.0 (Cy 1)	[2.108, 2.601, 3.106]	0.00	0.0	0.99946	0.00045	0.2390	3a, 3b, 3c, 3d
MG2	0.0 (Cy 6)	2.92, 3.204, 3.40, [3.60]	11.67	78.0	0.98541	0.00050	0.2351	
MG3	62.4 (Cy 6)	2.92, 3.204, 3.40, 3.60	14.34	62.7	0.98771	0.00049	0.2375	
MG4	0.0 (Cy 7)	2.92, 3.204, 3.40, 3.60, [3.75]	10.76	130.0	0.98954	0.00047	0.2362	

Table III-6. General McGuire Unit 1 CRC Statepoint Information (Continued)

Case	Cycle Length to Statepoint (EFPD, Cycle) ^a	Initial Enrichments (wt. % ²³⁵ U) ^a	Core Average Burnup (GWd/MTU) ^b	Downtime (d) ^a	k _{eff} ^a	σ ^a	AENCF ^c (MeV)	CC ^d
MG5	129.0 (Cy 7)	2.92, 3.204, 3.40, 3.60, 3.75	16.14	29.6	0.99175	0.00046	0.2388	
MG6	282.3 (Cy 7)	2.92, 3.204, 3.40, 3.60, 3.75	22.54	18.8	0.98723	0.00049	0.2426	

NOTES: ^aValues are from CRWMS M&O 1998d, p. 41.

^bSimple average of statepoint assemblies nodal height weighted averages from CRWMS M&O 1998e, Sections 3 and 4.

^cValues are from CRWMS M&O 1999b, pp. 60, 61, and 64 to 66.

^dCC = configuration class applicability (IP-).

III.2.1.5 Grand Gulf Unit 1

The Grand Gulf Unit 1 plant operated by Entergy Operations Inc is a 3833 MWt General Electric BWR with 800 8x8 and 9x9 fuel assemblies. A total of 16 CRC statepoints have been evaluated for Grand Gulf Unit 1 (Harwell 2003, p. 78).

Table III-7 provides some general information about the Grand Gulf Unit 1 CRC experiments. The information includes the statepoint cycle length in EFPD, the core average burnup, the initial weight percent enrichments of the fuel batches in the core during the CRC experiment (fresh fuel is identified by “[]” around the enrichment values), the down time in days since the core was last at power before restarting, along with the calculated k_{eff} values, sigma, and AENCF.

Table III-7. General Grand Gulf Unit 1 CRC Statepoint Information

Case	Cycle Length to Statepoint (EFPD, Cycle) ^a	Initial Enrichments (Wt. % ²³⁵ U) ^a	Core Average Burnup (MWd/MTU) ^c	Downtime (d) ^b	k _{eff}	σ	AENCF (MeV)	CC ^d
SP5	0.0 (Cy 4)	2.81, 3.01, [3.25, 3.37]	11	41.4	0.99554	0.0001	0.1737	
SP6	4.01 (Cy 4)	2.81, 3.01, 3.25, 3.37	11	17.7	0.99324	0.0001	0.1762	
SP7	73.49 (Cy 4)	2.81, 3.01, 3.25, 3.37	13	8.5	0.99296	0.0001	0.1785	
SP10	0.0 (Cy 5)	3.01, 3.25, 3.37, [3.42]	13	55.8	0.99461	0.0001	0.1733	
SP11	16.54 (Cy 5)	3.01, 3.25, 3.37, 3.42	13	11.4	0.99810	0.0001	0.1763	

Table III-7. General Grand Gulf Unit 1 CRC Statepoint Information (Continued)

Case	Cycle Length to Statepoint (EFPD, Cycle) ^a	Initial Enrichments (Wt. % ²³⁵ U) ^a	Core Average Burnup (MWd/MTU) ^c	Downtime (d) ^b	k _{eff}	σ	AENCF (MeV)	CC ^d
SP12	148.27 (Cy 5)	3.01, 3.25, 3.37, 3.42	17	4.8	0.98685	0.0001	0.1813	3a, 3b, 3c, 3d
SP13	165.29 (Cy 5)	3.01, 3.25, 3.37, 3.42	17	3.5	0.98551	0.0001	0.1812	
SP14	203.58 (Cy 5)	3.01, 3.25, 3.37, 3.42	18	7.7	0.98295	0.0001	0.1807	
SP15	340.41 (Cy 5)	3.01, 3.25, 3.37, 3.42	22	10.3	0.98309	0.0001	0.1811	
SP16	0.0 (Cy 6)	3.25, 3.37, 3.42, [2.94, 3.38]	13	48.3	0.99875	0.0001	0.1727	
SP18	0.0 (Cy 7)	2.94, 3.38, 3.42, [3.20, 3.42]	14	60.0	0.98993	0.0001	0.1733	
SP19	108.81 (Cy 7)	2.94, 3.20, 3.38, 3.42	17	5.8	0.98249	0.0001	0.1915	
SP20	245.05 (Cy 7)	2.94, 3.20, 3.38, 3.42	20	3.9	0.96644	0.0001	0.1900	
SP21	0.0 (Cy 8)	2.94, 3.20, 3.38, 3.42, [3.07, 3.56]	13	56.2	0.99211	0.0001	0.1740	
SP22	0.0 (Cy 8)	2.94, 3.20, 3.38, 3.42, [3.07, 3.56]	13	3.8	0.99380	0.0001	0.1748	
SP23	17.59 (Cy 8)	2.94, 3.07, 3.20, 3.38, 3.42, 3.56	14	4.4	0.98986	0.0001	0.1783	

NOTES: ^a Values are from Punatar (2001b, pp. 3-1 and 3-2).
^b Values are from Harwell (2003, p. 10).
^c Values are from Massie (2003, Table 2).
^d CC = configuration class applicability (IP-).

III.2.2 Lattice Laboratory Critical Experiments

The fresh fuel LCEs presented in this section represent moderated lattice configurations containing fissile oxide fuel. Each of the LCE configurations described in this section has been analyzed with the MCNP code system and used a water-scattering kernel corresponding to a temperature of 300 K. An experiment identifier for each benchmark configuration is provided for subsequent reference. The k_{eff}, σ, and AENCF values for each of the LCEs described in the following sections were taken from Section 4 of *Summary Report of Laboratory Critical Experiment Analyses Performed for the Disposal Criticality Analysis Methodology* (CRWMS M&O 1999a).

In the subsequent tables the P/D term represents the pin pitch to pin outer diameter ratio and CC indicates configuration class applicability (IP-).

III.2.2.1 Critical Configurations of Subcritical Clusters of 2.35 Weight Percent Enriched UO₂ Rods in Water with Fixed Neutron Absorber Plates

Experiments with subcritical clusters of low-enrichment UO₂ fuel rods were performed at the Pacific Northwest Laboratory (PNL) and documented by Bierman et al. (1977). The four experiments represented with MCNP consisted of three rectangular arrays of aluminum-clad fuel rods. The fuel rods comprising the arrays had a uniform enrichment of 2.35 weight percent ²³⁵U with a 2.032 cm pitch and pellet and cladding outer diameters of 1.12 and 1.27 cm, respectively (Bierman et al. 1977, p. 7). The three arrays of fuel were arranged in a row and, in three of the experiments, sheets of neutron poison were interposed between adjacent arrays. The pertinent differences among these four experiments are shown in Table III-8F. These critical experiments help demonstrate the ability of MCNP to accurately predict the critical multiplication factor for configurations containing light-water reactor fuel separated by absorber plates.

Table III-8. Clusters of 2.35 Weight Percent ²³⁵U-Enriched UO₂ Fuel Rods with Different Absorber Plates

Exp ID	Interposed plate	P/D	k _{eff}	σ	AENCF (MeV)	CC
exp1	None	1.81	1.00084	0.00088	0.12095	2a, 3a, 3b, 3c, 3d, 4a
exp2	BoralTM	1.81	0.99842	0.00088	0.12469	1a, 1b, 2a, 3a, 3b, 3c, 3d
exp3	Aluminum Type 6061	1.81	0.99898	0.00089	0.12172	
exp4	Stainless Steel Type 304	1.81	1.00104	0.00087	0.12003	

III.2.2.2 Water-Reflected Fuel Rod Clusters in Square Pitched Arrays

A series of critical experiments with clusters of aluminum clad UO₂ fuel rods in a large water-filled tank was performed over a period of several years at the Critical Mass Laboratory at PNL. Eight cases were analyzed under this category that correspond to water-reflected clusters at 2.032 cm square pitch with no absorber plates, reflecting walls, dissolved poison, or gadolinium impurity. Table III-9 provides a brief description of the experiments that come from *International Handbook of Evaluated Criticality Safety Benchmark Experiments* (NEA 1998, Volume IV, LEU-COMP-THERM-001, p. 10). Each of the experiments used 2.35 weight percent ²³⁵U-enriched UO₂ fuel with an average loading of 17.08 g of ²³⁵U per rod, with pellet and cladding outer diameters of 1.12 and 1.27 cm, respectively (NEA 1998, LEU-COMP-THERM-001, Volume IV, pp. 7 and 21).

Table III-9. Water-Reflected Fuel Rod Cluster Critical Experiments

Exp ID	Description Number of Rodsa (X×Y), Number of Clusters, Cluster Separation	P/D	k _{eff}	σ	AENCF (MeV)	CC
Case 1	20×18.08, 1 cluster	1.81	0.99436	0.00167	0.1229	1a, 2a, 3a, 3b, 3c, 3d, 4a
Case 2	20×17, 3 clusters, 11.92 ± 0.04 cm separation	1.81	0.99445	0.00158	0.1223	
Case 3b	20×16, 3 clusters, 8.41 ± 0.05 cm separation	1.81	0.99982	0.00159	0.1200	
Case 4	20×16 (center), 22×16 (two outer), 3 clusters, 10.05 ± 0.05 cm separation	1.81	0.99313	0.00161	0.1222	

Table III-9. Water-Reflected Fuel Rod Cluster Critical Experiments (Continued)

Exp ID	Description Number of Rods (X×Y), Number of Clusters, Cluster Separation	P/D	k _{eff}	σ	AENCF (MeV)	CC
Case 5	20×15, 3 clusters, 6.39 ± 0.05 cm separation	1.81	0.99310	0.00169	0.1204	
Case 6	20×15 (center), 24×15 (two outer), 3 clusters, 8.01 ± 0.06 cm separation	1.81	0.99831	0.00158	0.1221	
Case 7	20×14, 3 clusters, 4.46 ± 0.10 cm separation	1.81	0.99261	0.00138	0.1211	
Case 8c	19×6, 3 clusters, 7.57 ± 0.04 cm separation	1.81	0.99888	0.00151	0.1209	

NOTES: ^aFor three-cluster configurations, the first dimension is along the direction of the cluster placement. The second dimension is the width of facing sides, as shown in Figure 5 of NEA 1998, Volume IV, p. 11 LEU-COMP-THERM-001.

^bThe cluster separation referenced was 8.41 cm, but footnote (d) in NEA 1998, Volume IV, LEU-COMP-THERM-001, p. 10, states that the cluster separation should be 0.762 cm less. Thus, 7.648 cm was represented in the MCNP case for the cluster separation.

^cThe cluster separation referenced was 7.57 cm, but footnote (d) in NEA 1998, Volume IV, LEU-COMP-THERM-001, p. 10, states that the cluster separation should be 0.762 cm less. Thus, 6.808 cm was represented in the MCNP case for the cluster separation.

III.2.2.3 Critical Configurations with Subcritical Clusters of 4.31 Weight Percent Enriched UO₂ Rods in Water with Reflecting Walls

Three experiments were performed at PNL and are documented in Bierman et al. (1981) and Bierman and Clayton (1981). In these experiments three similar fuel assemblies were laterally surrounded by reflectors of different compositions. The fuel lattices in each critical experiment contained 4.31 weight percent ²³⁵U-enriched UO₂ fuel rods on a square pitch of 1.892 cm. The distinguishing characteristics of each experiment are given in Table III-10.

Table III-10. Clusters of 4.31 Weight Percent ²³⁵U-Enriched UO₂ Fuel Rods with Different Reflectors

Exp ID	Reflector	P/D	k _{eff}	σ	AENCF (MeV)	CC
exp5	uranium	1.50	1.00037	0.00107	0.27968	1a, 1b, 2a, 3a, 3b, 3c, 3d, 4a
exp6	lead	1.50	0.99675	0.00103	0.17662	
exp7	stainless steel	1.50	0.99724	0.00111	0.1784	

III.2.2.4 Critical Configurations with 4.31 Weight Percent ²³⁵U-Enriched UO₂ Rods in Highly Borated Water Lattices

A set of four experiments was performed at PNL and documented by Durst et al. (1982). These experiments used 4.31 weight percent ²³⁵U-enriched UO₂ fuel rods arranged in square-pitch, water-moderated lattices of different size with various amounts of boric acid in the moderator. The characteristics of each of these experiments is provided in Table III-11.

Table III-11. Configurations with 4.31 Weight Percent ²³⁵U-Enriched UO₂ Fuel Rods in Highly Borated Water Lattices

Exp ID	Description Pitch, # of Fuel Rods, Moderator	P/D	k _{eff}	σ	AENCF (MeV)	CC
exp8	1.89 cm, 357, nonborated water	1.50	1.00719	0.00110	0.17735	1a, 1b, 3a, 3b, 3c, 3d, 4a, 4b, 5a, 6a
exp9	1.89 cm, 1237, water with 2.55 g/l of boron	1.50	1.00827	0.00099	0.22171	
exp10	1.715 cm, 509, nonborated water	1.36	1.00660	0.00174	0.2239	
exp11	1.715 cm, 1192, water with 2.55 g/l of boron	1.36	1.00358	0.00157	0.26643	

III.2.2.5 Critical Configurations with Neutron Flux Traps

PNL performed experiments studying the effect of neutron flux traps on criticality. These experiments were documented by Bierman (1990) and served as the source for two configurations represented with MCNP. These two critical experiments were each composed of four fuel rod arrays arranged in a square and separated by a neutron flux trap region. Each fuel lattice in a given configuration was nearly equal in size. The fuel rods were composed of aluminum-clad 4.31 weight percent ²³⁵U-enriched UO₂ fuel rods with a 1.891 cm pitch. The neutron flux traps were created by positioning two plates of Boral™ between interacting faces of each fuel lattice. The experimental configurations were moderated and closely reflected by full-density water. A brief description of these experiments is provided in Table III-12.

Table III-12. Configurations with Neutron Flux Traps

Exp ID	Configuration Description	P/D	k _{eff}	σ	AENCF (MeV)	CC
exp12	952 rods arranged in three 15×16 arrays, one 15×15 array, and a 15×15 array with a partial row of 7 rods	1.49	1.00546	0.00108	0.19461	1a, 2a, 3a, 3b, 3c, 3d, 4a, 4b, 5a, 6a
exp13	862 rods arranged in two 14×15 arrays, one 15×15 array, and a 14×15 array with a partial fifteenth row of 7 fuel rods	1.49	1.00371	0.00113	0.19421	

III.2.2.6 Electric Power Research Institute 2.35 Weight Percent ²³⁵U-Enriched Light Water Reactor Fuel Critical Configurations

Criticality experiments were sponsored by Electric Power Research Institute (EPRI) for light water reactor fuel configurations. These were documented by EPRI and subsequently described in *Analysis of Fresh Fuel Critical Experiments Appropriate for Burnup Credit Validation* (ORNL 1995, p. 52). Two critical experiment configurations composed of water-moderated lattices of 2.35 weight percent ²³⁵U-enriched UO₂ fuel rods were represented with MCNP. The fuel rods were supported in a core structure composed of "eggcrate" type lattice plates with an upper lead shield. The configuration was closely reflected by full-density water laterally and below the fuel. These experiments are shown in Table III-13.

Table III-13. EPRI 2.35 Weight Percent ²³⁵U-Enriched UO₂ Critical Configurations

Exp ID	Description Pitch, # of Fuel Rods	P/D	k _{eff}	σ	AENCF (MeV)	CC
exp14	1.562 cm, 708 ^a	1.40	0.99593	0.00099	0.20945	1a, 2a, 3a, 3b, 3c, 3d, 4a
exp15	2.210 cm, 342	1.98	1.00074	0.00087	0.10984	

NOTE: ^aThe MCNP representation used 709 rods due to symmetry used in the input specifications.

III.2.2.7 Water-Moderated, Lead-Reflected Uranium Dioxide Rod Array

This case is documented in *International Handbook of Evaluated Criticality Safety Benchmark Experiments* (NEA 1998, Volume IV, LEU-COMP-THERM-027, Sections 1, 2, and 3), and consisted of a 14×14 array of 4.74 weight percent ²³⁵U-enriched UO₂ fuel rods reflected on four sides by 30 cm-thick lead reflectors with no water gap between the array and the lead reflectors. This experiment was denoted as lct27-1 with relevant information listed in Table III-14. The experiment was a subcritical approach extrapolated to critical; the neutron multiplication factor reached is within 0.1 percent of 1.000. The experiments were tests of the lead reflector effect.

Table III-14. Lead-Reflected UO₂ Rod Array Critical Experiment

Exp ID	Pitch	P/D	k _{eff}	σ	AENCF (MeV)	CC
lct27-1	1.6 cm	2.03	1.0157	0.0005	0.1025	1a, 1b, 2a, 3a, 3b, 3c, 3d, 4a

III.2.2.8 Laboratory Critical Experiments from the Urania-Gadolinia: Nuclear Model Development and Critical Experiment Benchmark Report

A number of critical experiments were performed by B&W for urania fuel incorporating gadolinia as an integral burnable absorber. These experiments were documented in Newman (1984). The configurations represented with MCNP included critical configurations containing arrangements of 2.46 weight percent ²³⁵U-enriched UO₂ fuel rods, 4.02 weight percent ²³⁵U-enriched UO₂ fuel rods, combination 4 weight percent Gd₂O₃ and 96 weight percent (1.944 weight percent ²³⁵U-enriched) UO₂ fuel rods, Ag-In-Cd absorber rods, and B₄C absorber rods. The central 45 × 45 array of rod lattice cells was separated into nine 15 × 15 arrays of rod lattice cells with a square pitch of 1.636 cm (0.644 in. [Newman 1984, p. 3-1]). The moderator-to-fuel volume ratio was between 2.7 and 3.2 depending on the fuel rod enrichment, which was calculated based on pitch and pellet dimensions from Newman (1984, pp. 3-6 and 3-7). These arrays were intended to simulate pressurized water reactor fuel assembly lattices.

Descriptions of the experimental configurations are provided in Table III-15.

Table III-15. Urania-Gadolinia Critical Experiments

Exp ID	Description ^a							Mod. Boron Conc. (ppm)	P/D	k _{eff}	σ	AENCF (MeV)	CC
	A	B	C	D	E	F	G						
ugd1	4808	0	0	0	0	0	153	1337.9	1.59	1.00033	0.00143	0.20132	2a, 3a, 3b, 3c, 3d, 4a
ugd2	4808	0	0	0	16	0	137	1250.0	1.59	0.99945	0.00145	0.19828	
ugd3	4788	0	20	0	0	0	153	1239.3	1.59	1.00054	0.00147	0.19948	
ugd4	4788	0	20	0	16	0	137	1171.7	1.59	1.00193	0.0015	0.19985	
ugd5	4780	0	28	0	0	0	153	1208.0	1.59	0.99955	0.00154	0.19752	
ugd6	4780	0	28	0	16	0	137	1155.8	1.59	0.99996	0.00152	0.19775	
ugd7	4780	0	28b	0	0	0	153	1208.8	1.59	1.0041	0.00148	0.19675	
ugd8	4772	0	36	0	0	0	153	1170.7	1.59	0.99929	0.00154	0.19756	
ugd9	4772	0	36	0	16	0	137	1130.5	1.59	1.00135	0.00156	0.19873	
ugd10	4772	0	36	0	0	16	137	1177.1	1.59	0.9979	0.00144	0.2011	
ugd12	3920	888	0	0	0	0	153	1899.3	1.56	0.9994	0.00161	0.20965	
ugd13	3920	888	0	16	0	0	137	1635.4	1.56	1.00049	0.00155	0.20841	
ugd14	3920	860	28	0	0	0	153	1653.8	1.56	1.00066	0.00156	0.20416	
ugd15	3920	860	28	16	0	0	137	1479.7	1.56	1.00158	0.00151	0.2056	
ugd16	3920	852	36	0	0	0	153	1579.4	1.56	1.00335	0.00151	0.20648	
ugd17	3920	852	36	16	0	0	137	1432.1	1.56	0.99912	0.00151	0.20341	
ugd18	3676	944	0	0	0	0	180	1776.8	1.56	0.99876	0.0015	0.20851	
ugd19	3676	928	16	0	0	0	180	1628.3	1.56	1.00133	0.00153	0.21011	
ugd20	3676	912	32	0	0	0	180	1499.0	1.56	1.00322	0.00153	0.20698	

NOTES: ^a Description column designations are as follows:

A - Number of 2.46 weight percent ²³⁵U fuel rods.

B - Number of 4.02 weight percent ²³⁵U fuel rods.

C - Number of Gd₂O₃ fuel rods.

D - Number of B₄C rods.

E - Number of Ag-In-Cd rods.

F - Number of void rods.

G - Number of water holes.

^b Annular Gd₂O₃ fuel rods.

III.2.2.9 Saxton UO₂ and PuO₂-UO₂ Critical Configurations

Single- and multi-region uranium and plutonium oxide fueled cores, water moderated, clean, and borated, have been used in a series of critical experiments at the Westinghouse Reactor Evaluation Center in support of the Saxton Plutonium Program. In this series of experiments, criticality was achieved entirely by varying the water level inside the core tank. The fuel used in the experiments was UO₂ fuel with 5.74 weight percent ²³⁵U enrichment and mixed oxide (MOX) fuel containing 6.6 weight percent PuO₂ and natural enriched UO₂ (Taylor 1965, p. A-1). This work was documented by Taylor (1965) and subsequently described in *Analysis of Fresh Fuel Critical Experiments Appropriate for Burnup Credit Validation* (ORNL 1995, pp. 52 and 60). This section includes eight single-region configurations and six multiregion configurations. The fuel rod type, pitch, array size, moderator height, and boron concentration

were adjusted in each LCE. Table III-16 presents a description of the various single-region experiments, and Table III-17 presents a description of the multiregion experiments.

Table III-16. Saxton Single-Region Critical Configurations

Exp ID	Description	P/D	k_{eff}	σ	AENCF (MeV)	CC
ssr83	Fuel: UO ₂ ; Pitch: 1.3208 cm; Configuration: 449 cylindrical; Critical water height: 95.25 cm	1.46	0.99299	0.00074	0.18197	1a, 2a, 3a, 3b, 3c, 3d, 4a
ssr48	Fuel: UO ₂ ; Pitch: 1.4224 cm; Configuration: 19×19 square; Critical water height: 83.71 cm	1.57	0.9939	0.00071	0.15568	
ssr70	Fuel: MOX; Pitch: 1.3208 cm; Configuration: 22×23 square; Critical water height: 84.56 cm	1.54	0.99543	0.00072	0.2295	
ssr57	Fuel: MOX; Pitch: 1.4224 cm; Configuration: 19×19 square; Critical water height: 82.46 cm	1.66	0.99807	0.00075	0.1938	
ssr27	Fuel: MOX; Pitch: 1.4224 cm; Configuration: 21×21 square; Critical water height: 89.70 cm	1.66	0.99881	0.00082	0.2015	
ssr66	Fuel: MOX; Pitch: 1.8669 cm; Configuration: 13×13 square; Critical water height: 70.11 cm	2.18	1.00308	0.00073	0.1183	
ssr53	Fuel: MOX; Pitch: 2.0117 cm; Configuration: 12×12 square; Critical water height: 78.43 cm	2.35	1.00454	0.00066	0.1065	
ssr74	Fuel: MOX; Pitch: 2.6416 cm; Configuration: 11×11 square; Critical water height: 81.17 cm	3.08	1.00505	0.00068	0.079	

Table III-17. Saxton Multiregion Critical Configurations

Exp ID	Description	P/D	k_{eff}	σ	AENCF (MeV)	CC
smr1	Configuration: 19×19 square - 11×11 MOX center region, UO ₂ outer region; Critical water height: 91.07 cm	1.60	0.99783	0.00073	0.1715	1a, 2a, 3a, 3b, 3c, 3d, 4a
smr9	Configuration: 19×19 square – 11×11 MOX center region, UO ₂ outer region with Al plate at the fuel interface; Critical water height: 92.07 cm	1.60	0.99683	0.00078	0.1673	
smr5	Configuration: 27×27 square - 19×19 UO ₂ center region, MOX outer region; Critical water height: 86.70 cm	1.61	0.99349	0.00073	0.1919	
smr11	Configuration: 27×27 square – 19×19 MOX center region, UO ₂ outer region with water slot at the region boundary; Critical water height: 99.80 cm	1.61	0.99783	0.00078	0.0205	
smr12	Configuration: 27×27 square - 19×19 MOX center region, UO ₂ outer region with Al slab at the interface; Critical water height: 106.35 cm	1.61	0.99992	0.0008	0.2049	
smr8	Configuration: 27×27 square - 19×19 MOX center region, UO ₂ outer region with L shaped UO ₂ insert in MOX region; Critical water height: 92.19 cm	1.61	0.99956	0.00068	0.2051	

III.2.2.10 Critical Configurations Simulating Light Water Reactor Fuel in Close Proximity Pool Storage

B&W performed experiments simulating neutron multiplication in pool storage racks. These were documented in Baldwin et al. (1979). Nineteen such critical configurations, each containing a 3×3 array of 14×14 fuel rod assemblies with a square pin pitch of 1.636 cm (0.644 in. [Baldwin et al. 1979, p. 3-3]), were represented with MCNP. The gaps between assemblies contained a number of B₄C rods and water, stainless steel sheets and water, borated aluminum sheets and water, or only water. The fuel rods were composed of 2.46 weight percent ²³⁵U-enriched UO₂ clad in Aluminum Type 6061 with a diameter of 1.03 cm (Baldwin et al. 1979, p. 8-2). The B₄C rods were aluminum tubes filled with B₄C powder. Six sets of borated aluminum sheets were used in the critical experiments. The soluble boron concentration and moderator heights were adjusted to obtain a critical configuration. The key parameters that distinguish the twenty critical configurations are shown in Table III-18.

Table III-18. Close Proximity Critical Benchmarks

Exp ID	Description	P/D	k _{eff}	σ	AENCF (MeV)	CC
core2	Assembly spacing (pin pitch): 0; # B ₄ C rods: 0; Metal between unit assemblies: N/A	1.59	1.00058	0.00159	0.19988	1a, 2a, 3a, 3b, 3c, 3d, 4a
core3	Assembly spacing (pin pitch): 1; # B ₄ C rods: 0; Metal between unit assemblies: N/A	1.59	1.00019	0.00148	0.18078	
core4	Assembly spacing (pin pitch): 1; # B ₄ C rods: 84; Metal between unit assemblies: N/A	1.59	0.9948	0.0015	0.17908	
core5	Assembly spacing (pin pitch): 2; # B ₄ C rods: 64; Metal between unit assemblies: N/A	1.59	0.99445	0.00153	0.16919	
core6	Assembly spacing (pin pitch): 2; # B ₄ C rods: 64; Metal between unit assemblies: N/A	1.59	0.99556	0.00152	0.17216	
core7	Assembly spacing (pin pitch): 3; # B ₄ C rods: 34; Metal between unit assemblies: N/A	1.59	0.99463	0.00151	0.15963	
core8	Assembly spacing (pin pitch): 3; # B ₄ C rods: 34; Metal between unit assemblies: N/A	1.59	0.98895	0.00149	0.16496	
core9	Assembly spacing (pin pitch): 4; # B ₄ C rods: 0; Metal between unit assemblies: N/A	1.59	0.99298	0.00144	0.15528	
core10	Assembly spacing (pin pitch): 3; # B ₄ C rods: N/A; Metal between unit assemblies: None	1.59	0.99511	0.00148	0.16036	
core11	Assembly spacing (pin pitch): 1; # B ₄ C rods: N/A; Metal between unit assemblies: SS	1.59	0.99699	0.00148	0.17893	
core12	Assembly spacing (pin pitch): 2; # B ₄ C rods: N/A; Metal between unit assemblies: SS	1.59	0.99549	0.00151	0.16671	
core13	Assembly spacing (pin pitch): 1; # B ₄ C rods: N/A; Metal between unit assemblies: B/AI set 5	1.59	0.99933	0.00151	0.18075	
core15	Assembly spacing (pin pitch): 1; # B ₄ C rods: N/A; Metal between unit assemblies: B/AI set 3	1.59	0.99107	0.00157	0.18348	
core16	Assembly spacing (pin pitch): 2; # B ₄ C rods: N/A; Metal between unit assemblies: B/AI set 3	1.59	0.99041	0.0015	0.16952	
core17	Assembly spacing (pin pitch): 1; # B ₄ C rods: N/A; Metal between unit assemblies: B/AI set 2	1.59	0.99365	0.00151	0.18187	
core18	Assembly spacing (pin pitch): 2; # B ₄ C rods: N/A; Metal between unit assemblies: B/AI set 2	1.59	0.9947	0.0015	0.16855	
core19	Assembly spacing (pin pitch): 1; # B ₄ C rods: N/A; Metal between unit assemblies: B/AI set 1	1.59	0.99383	0.00153	0.18354	
core20	Assembly spacing (pin pitch): 2; # B ₄ C rods: N/A; Metal between unit assemblies: B/AI set 1	1.59	0.99392	0.00151	0.16933	
core21	Assembly spacing (pin pitch): 3; # B ₄ C rods: N/A; Metal between unit assemblies: B/AI set 1	1.59	0.9916	0.0014	0.16225	

III.2.2.11 Electric Power Research Institute Mixed Oxide Critical Configurations

Analysis of Fresh Fuel Critical Experiments Appropriate for Burnup Credit Validation (ORNL 1995, p. 60) describes criticality tests with MOX fuel performed for EPRI. Six critical experiment configurations composed of unborated and borated water moderated lattices of 2 weight percent PuO₂ (8 weight percent plutonium-240) and 98 weight percent natural UO₂ fuel rods were represented with MCNP. Although the relative distribution of the plutonium isotopes differs from that found in burned light water reactor fuel, the ratio of plutonium/²³⁵U (2.79) bounds that calculated for such fuel (1.01) (ORNL 1995, p. 60). The fuel rods were 1.283 cm in

diameter (ORNL 1995, p. 65), clad with aluminum, and supported in a core structure composed of "eggcrate" type lattice plates with an upper lead shield. The configurations were closely reflected with full-density water laterally and below the core. These experiments are denoted as "exp22" through "exp27" and brief descriptions of the variations are provided in Table III-19.

Table III-19. EPRI Mixed Oxide Critical Configurations

Exp ID	Description	P/D	k_{eff}	σ	AENCF (MeV)	CC
exp22	Pitch =1.778 cm, 469 fuel rods, unborated water moderator	1.39	0.99624	0.00174	0.25557	1a, 2a, 3a, 3b, 3c, 3d, 4a
exp23	Pitch =1.778 cm, 761 fuel rods, 680.9 ppm borated water moderator	1.39	1.0005	0.00169	0.27397	
exp24	Pitch =2.210 cm, 197 fuel rods, unborated water moderator	1.72	1.00302	0.00171	0.16128	
exp25	Pitch =2.210 cm, 761 fuel rods, 1090.4 ppm borated water moderator	1.72	1.00835	0.00161	0.18944	
exp26	Pitch =2.515 cm, 160 fuel rods, unborated water moderator	1.96	1.00709	0.0016	0.13192	
exp27	Pitch =2.515 cm, 689 fuel rods, 767.2 ppm borated water moderator	1.96	1.00752	0.00155	0.15372	

III.2.2.12 Critical Triangular Lattice of MOX and UO₂ Fuel Rods

Bierman et al. (1984) documented critical experiments performed at PNL incorporating both uranium and MOX fuel rods in a triangular lattice. One such experiment, designated "exp34," contained a triangular lattice of uniformly distributed PuO₂-UO₂ and UO₂ fuel rods. The fuel rods were placed in a uniform distribution with a plutonium/²³⁵U ratio approximating that of a 20,000 MWd/MTU burnup. Each PuO₂-UO₂ fuel rod was surrounded by six UO₂ fuel rods with a triangular lattice pitch. The UO₂ rods were 4.31 weight percent ²³⁵U-enriched, and the MOX fuel was 2 weight percent PuO₂ and 98 weight percent natural UO₂. Information for this experiment is provided in Table III-20.

Table III-20. Critical Configuration of MOX and UO₂ Fuel Rods in a Triangular Lattice

Exp ID	Description	P/D ^b	k_{eff}	σ	AENCF (MeV)	CC
exp34	583 MOX fuel rods with 1174 UO ₂ fuel rods with a 1.598 cm pitch ^a	1.26	0.9875	0.00168	0.37762	2a, 3a, 3b, 3c, 3d, 4a

NOTES: ^a Configuration evaluated corresponds to lattice 32 in Bierman et al. 1984, p. F.66.

^b Fuel pellet dimensions from Bierman et al. 1984, pp. 2.9 and 2.10.

III.2.3 Homogeneous Solution Experiments

The LCEs presented in this section represent solutions containing uranium, plutonium, or both uranium and plutonium. Each of the LCE configurations described in this section have been analyzed with the MCNP code system. An experiment identifier for each configuration is provided for subsequent reference in this document. With a few exceptions that are noted in the text, the assessed benchmarks come from *International Handbook of Evaluated Criticality Safety Benchmark Experiments* (NEA 1998).

The following sections briefly describe the LCEs according to the grouping in which the results are presented.

III.2.3.1 Mixed Plutonium and Natural Uranium Nitrate Solutions

The experiments involving plutonium and uranium with naturally occurring isotopic ratios are from *International Handbook of Evaluated Criticality Safety Benchmark Experiments* (NEA 1998, Volume VI) and are listed in Table III-21.

Table III-21. Configurations Incorporating Mixed Plutonium and Natural Uranium Nitrate Solutions

Exp ID	Description	k_{eff}	σ	AENCF (MeV)	CC
Water Reflected Annular Cylindrical Tank with Central Bottle and Annular Inserts (NEA 1998, Volume VI, MIX-SOL-THERM-001, Sections 1, 2, and 3)					
PNL3187	102.19 g Pu/l, 365.20 g U/l, 2% B ₄ C Concrete Annulus, No Bottle, CH: 48.55 cm, H/ ²³⁹ Pu (annular tank) = 234, 91.118 wt. % ²³⁹ Pu in Pu	0.99821	0.00116	0.04158	1a, 1b, 2a, 4a, 4b, 5a, 6a
PNL3391	103.37 g Pu/l, 363.66 g U/l, 0% B ₄ C Concrete Annulus, Bottle 2, CH: 27.67 cm, H/ ²³⁹ Pu (annular tank) = 231, H/ ²³⁹ Pu (bottle) = 231, 91.118 wt. % ²³⁹ Pu in Pu	0.99318	0.00112	0.04075	
PNL3492	103.37 g Pu/l, 363.66 g U/l, 1% B ₄ C Concrete Annulus, Bottle 2, CH: 37.19 cm, H/ ²³⁹ Pu (annular tank) = 225, H/ ²³⁹ Pu (bottle) = 231, 91.117 wt. % ²³⁹ Pu in Pu	0.99619	0.00113	0.04386	
PNL3593	107.91 g Pu/l, 379.55 g U/l, 6% B ₄ C Concrete Annulus, Bottle 2, CH: 51.10 cm, H/ ²³⁹ Pu (annular tank) = 220, H/ ²³⁹ Pu (bottle) = 231, 91.117 wt. % ²³⁹ Pu in Pu	0.99694	0.00121	0.04614	
PNL3694	108.27 g Pu/l, 380.41 g U/l, No Concrete Annulus, Bottle 2, CH: 32.86 cm, H/ ²³⁹ Pu (annular tank) = 219, H/ ²³⁹ Pu (bottle) = 231, 91.117 wt. % ²³⁹ Pu in Pu	1.00275	0.00113	0.04483	
PNL3795	195.61 g Pu/l, 6.5 g U/l, 2% B ₄ C Concrete Annulus, Bottle 3, CH: 27.51 cm, H/ ²³⁹ Pu (annular tank) = 125, H/ ²³⁹ Pu (bottle) = 126, 91.572 wt. % ²³⁹ Pu in Pu	1.00302	0.00117	0.03965	
PNL3896	110.13 g Pu/l, 3.8 g U/l, 2% B ₄ C Concrete Annulus, Bottle 3, CH: 25.69 cm, H/ ²³⁹ Pu (annular tank) = 242, H/ ²³⁹ Pu (bottle) = 126, 91.572 wt. % ²³⁹ Pu in Pu	1.00263	0.0011	0.02357	
PNL3897	58.30 g Pu/l, 2.3 g U/l, 2% B ₄ C Concrete Annulus, Bottle 3, CH: 28.94 cm, H/ ²³⁹ Pu (annular tank) = 477, H/ ²³⁹ Pu (bottle) = 126, 91.572 wt. % ²³⁹ Pu in Pu	1.00323	0.00125	0.01447	
PNL3898	72.74 g Pu/l, 247.33 g U/l, 2% B ₄ C Concrete Annulus, Bottle 2, CH: 39.58 cm, H/ ²³⁹ Pu (annular tank) = 354, H/ ²³⁹ Pu (bottle) = 231, 91.117 wt. % ²³⁹ Pu in Pu	1.00297	0.00118	0.02973	

Table III-21. Configurations Incorporating Mixed Plutonium and Natural Uranium Nitrate Solutions (Continued)

Exp ID	Description	k_{eff}	σ	AENCF (MeV)	CC
PNL3808	47.08 g Pu/l, 161.72 g U/l, 2% B ₄ C Concrete Annulus, Bottle 2, CH: 45.09 cm, H/ ²³⁹ Pu (annular tank) = 569, H/ ²³⁹ Pu (bottle) = 231, 91.117 wt. % ²³⁹ Pu in Pu	1.00178	0.00095	0.02059	1a, 1b, 2a, 4a, 4b, 5a, 6a
PNL3999	73.64 g Pu/l, 250.30 g U/l, Polyethylene with Cd Cover Annulus, Bottle 2, CH: 79.18 cm, H/ ²³⁹ Pu (annular tank) = 349, H/ ²³⁹ Pu (bottle) = 349, 91.117 wt. % ²³⁹ Pu in Pu	1.00707	0.00108	0.02933	
PNL5300	74.25 g Pu/l, 251.64 g U/l, Solid Polyethylene with Cd Cover Center, CH: 104.62 cm, H/ ²³⁹ Pu (annular tank) = 346, 91.117 wt. % ²³⁹ Pu in Pu	1.0067	0.00105	0.02917	
Water Reflected Cylindrical Tank With a 68.68 cm Inner Diameter (ID), 91.102 wt. % ²³⁹Pu in Pu (NEA 1998, Volume VI, MIX-SOL-THERM-002, Sections 1, 2, and 3)					
PNL1158	11.83 g Pu/l, 11.05 g U/l, CH: 76.80 cm, H/ ²³⁹ Pu = 2,403	1.00686	0.00067	0.00393	1a, 1b, 2a, 4a, 4b, 5a, 6a
PNL1159	11.73 g Pu/l, 10.78 g U/l, CH: 83.14 cm, H/ ²³⁹ Pu = 2,435	1.00558	0.00064	0.0038	
PNL1161	12.19 g Pu/l, 41.04 g U/l, CH: 81.72 cm, H/ ²³⁹ Pu = 2,317	1.00751	0.00066	0.00597	
Water/Polyethylene Reflected Cylindrical Tank With Various Diameters, 93.95 wt. % ²³⁹Pu in Pu (NEA 1998, Volume VI, MIX-SOL-THERM-003, Sections 1, 2, and 3)					
awre1	101.3 g Pu/l, 228.5 g U/l, ID = 25.425 cm, CH: 56.31 cm, H/ ²³⁹ Pu = 239	1.01511	0.0012	0.03133	1a, 1b, 2a, 4a, 4b, 5a, 6a
awre2	101.3 g Pu/l, 228.5 g U/l, ID = 30.62 cm, CH: 29.89 cm, H/ ²³⁹ Pu = 239	1.01167	0.00117	0.03206	
awre3	101.3 g Pu/l, 228.5 g U/l, ID = 37.99 cm, CH: 21.17 cm, H/ ²³⁹ Pu = 239	1.01028	0.00114	0.03183	
awre4	101.3 g Pu/l, 228.5 g U/l, ID = 50.72 cm, CH: 16.05 cm, H/ ²³⁹ Pu = 239	1.00486	0.00111	0.03228	
awre5	31.58 g Pu/l, 71.3 g U/l, ID = 30.62 cm, CH: 46.18 cm, H/ ²³⁹ Pu = 847	1.00875	0.00101	0.01062	
awre6	31.58 g Pu/l, 71.3 g U/l, ID = 37.99 cm, CH: 28.24 cm, H/ ²³⁹ Pu = 847	1.01337	0.00108	0.01053	
awre7	31.58 g Pu/l, 71.3 g U/l, ID = 50.72 cm, CH: 20.39 cm, H/ ²³⁹ Pu = 847	1.0064	0.00102	0.01089	
awre8	18.61 g Pu/l, 42.2 g U/l, ID = 37.99 cm, CH: 72.86 cm, H/ ²³⁹ Pu = 1461	1.01255	0.00091	0.00684	
awre9	18.61 g Pu/l, 42.2 g U/l, ID = 50.72 cm, CH: 33.59 cm, H/ ²³⁹ Pu = 1461	1.00977	0.00088	0.00684	
awre10	17.50 g Pu/l, 39.6 g U/l, ID = 50.72 cm, CH: 37.16 cm, H/ ²³⁹ Pu = 1556	1.00839	0.00081	0.00648	
Cylindrical Tank With a 35.39 cm ID and either Water Reflector, Concrete Reflector, or No Reflector, 91.118 wt. % ²³⁹Pu in Pu (NEA 1998, Volume VI, MIX-SOL-THERM-004, Sections 1, 2, and 3)					
PNL1577	172.56 g Pu/l, 262.79 g U/l, No Reflector, CH: 57.97 cm, H/ ²³⁹ Pu = 137	0.99645	0.00128	0.05956	1a, 1b, 2a, 4a, 4b, 5a, 6a
PNL1678	172.82 g Pu/l, 262.55 g U/l, Water Reflector, CH: 28.93 cm, H/ ²³⁹ Pu = 136	0.99976	0.00115	0.05069	
PNL1783	173.22 g Pu/l, 262.88 g U/l, Concrete Reflector, CH: 30.60 cm, H/ ²³⁹ Pu = 136	0.99976	0.00115	0.05386	

Table III-21. Configurations Incorporating Mixed Plutonium and Natural Uranium Nitrate Solutions (Continued)

Exp ID	Description	k_{eff}	σ	AENCF (MeV)	CC
PNL1868	118.71 g Pu/l, 173.98 g U/l, Concrete Reflector, CH: 27.03 cm, H/ ²³⁹ Pu = 214	1.00247	0.00119	0.03416	1a, 1b, 2a, 4a, 4b, 5a, 6a
PNL1969	119.04 g Pu/l, 174.67 g U/l, Water Reflector, CH: 25.26 cm, H/ ²³⁹ Pu = 213	0.99967	0.00111	0.0336	
PNL2070	118.90 g Pu/l, 174.53 g U/l, No Reflector, CH: 41.08 cm, H/ ²³⁹ Pu = 214	0.99925	0.00115	0.03743	
PNL2565	41.69 g Pu/l, 63.38 g U/l, No Reflector, CH: 44.46 cm, H/ ²³⁹ Pu = 664	1.00363	0.00112	0.01295	
PNL2666	41.89 g Pu/l, 63.65 g U/l, Water Reflector, CH: 28.11 cm, H/ ²³⁹ Pu = 660	1.00337	0.00105	0.0116	
PNL2767	41.83 g Pu/l, 63.55 g U/l, Concrete Reflector, CH: 29.36 cm, H/ ²³⁹ Pu = 661	1.00629	0.00113	0.01197	

NOTE: CH = Critical Height.

III.2.3.2 Plutonium Nitrate Solutions

The experiments involving plutonium are from *International Handbook of Evaluated Criticality Safety Benchmark Experiments* (NEA 1998, Volume I) and are listed in Table III-22.

Table III-22. Configurations Incorporating Plutonium Nitrate Solutions

Exp ID	Description	k_{eff}^a	σ	AENCF (MeV)	CC
Water Reflected 11.5-Inch Diameter Spheres, 0.049-in. thick shell of Stainless Steel Type 304L, 4.57 wt. % ²⁴⁰Pu in Pu, 95.12 wt. % ²³⁹Pu in Pu (NEA 1998, Volume I, PU-SOL-THERM-001, Sections 1, 2, and 3)					
pust1t1	73.0 g Pu/liter, CM: 945 gm, H/ ²³⁹ Pu = 371	1.00995	0.00102	0.01252	1a, 1b, 2a, 4a, 4b, 5a, 6a
pust1t2	96.0 g Pu/liter, CM: 1243 gm, H/ ²³⁹ Pu = 272	1.01109	0.001	0.01702	
pust1t3	119.0 g Pu/liter, CM: 1541 gm, H/ ²³⁹ Pu = 216	1.01396	0.00094	0.02159	
pust1t4	132.0 g Pu/liter, CM: 1709 gm, H/ ²³⁹ Pu = 190	1.00643	0.00104	0.02397	
pust1t5	140.0 g Pu/liter, CM: 1813 gm, H/ ²³⁹ Pu = 180	1.01014	0.00101	0.02479	
pust1t6	268.7 g Pu/liter, CM: 3480 gm, H/ ²³⁹ Pu = 91	1.00831	0.00104	0.04809	
Water Reflected 13-Inch Diameter Spheres, 0.050-in. thick shell of Stainless Steel Type 347 Unless Otherwise Indicated (NEA 1998, Volume I, PU-SOL-THERM-003, Sections 1, 2, and 3)					
pu003-1	33.32 g Pu/liter, CM: 631 gm, H/ ²³⁹ Pu = 788, 1.76 wt. % ²⁴⁰ Pu	1.00962	0.00091	0.00623	1a, 1b, 2a, 4a, 4b, 5a, 6a
pu003-2	34.32 g Pu/liter, CM: 650 gm, H/ ²³⁹ Pu = 756, 1.76 wt. % ²⁴⁰ Pu	1.00885	0.00091	0.00651	
pu003-3	37.43 g Pu/liter, CM: 709 gm, H/ ²³⁹ Pu = 699, 3.12 wt. % ²⁴⁰ Pu	1.01228	0.00092	0.00693	
pu003-4	38.12 g Pu/liter, CM: 722 gm, H/ ²³⁹ Pu = 682, 3.12 wt. % ²⁴⁰ Pu	1.00965	0.00094	0.0072	

Table III-22. Configurations Incorporating Plutonium Nitrate Solutions (Continued)

Exp ID	Description	k_{eff}^a	σ	AENCF (MeV)	CC
pu003-5	40.65 g Pu/liter, CM: 770 gm, $H/^{239}Pu = 627$, 3.12 wt. % ^{240}Pu	1.01393	0.00092	0.00785	
pu003-6	44.09 g Pu/liter, CM: 835 gm, $H/^{239}Pu = 563$, 3.12 wt. % ^{240}Pu	1.01214	0.00091	0.00845	
pu003-7	35.98 g Pu/liter, CM: 649 gm, $H/^{239}Pu = 738$, 3.12 wt. % ^{240}Pu , 20 Gauge 2S Al Shell	1.01369	0.00093	0.00678	
pu003-8	36.81 g Pu/liter, CM: 664 gm, $H/^{239}Pu = 714$, 3.12 wt. % ^{240}Pu , 20 Gauge 2S Al Shell	1.01175	0.00095	0.00703	
Water Reflected 14-Inch Diameter Spheres, 0.050-in. thick shell of Stainless Steel Type 347 (NEA 1998, Volume I, PU-SOL-THERM-004, Sections 1, 2, and 3)					
pu004-1	26.27 g Pu/liter, CM: 621 gm, $H/^{239}Pu = 987$, 0.54 wt. % ^{240}Pu	1.01134	0.00088	0.00524	1a, 1b, 2a, 4a, 4b, 5a, 6a
pu004-2	26.31 g Pu/liter, CM: 622 gm, $H/^{239}Pu = 977$, 0.54 wt. % ^{240}Pu	1.00448	0.00082	0.00541	
pu004-3	27.20 g Pu/liter, CM: 643 gm, $H/^{239}Pu = 935$, 0.54 wt. % ^{240}Pu	1.00916	0.00087	0.00538	
pu004-4	28.09 g Pu/liter, CM: 664 gm, $H/^{239}Pu = 889$, 0.54 wt. % ^{240}Pu	1.00712	0.00086	0.00561	
pu004-5	27.58 g Pu/liter, CM: 652 gm, $H/^{239}Pu = 942$, 1.76 wt. % ^{240}Pu	1.00753	0.00091	0.00543	
pu004-6	28.60 g Pu/liter, CM: 676 gm, $H/^{239}Pu = 927$, 3.12 wt. % ^{240}Pu	1.00862	0.00087	0.00564	
pu004-7	29.57 g Pu/liter, CM: 699 gm, $H/^{239}Pu = 892$, 3.12 wt. % ^{240}Pu	1.01248	0.0009	0.0056	
pu004-8	29.95 g Pu/liter, CM: 708 gm, $H/^{239}Pu = 869$, 3.12 wt. % ^{240}Pu	1.00778	0.00086	0.0062	
pu004-9	31.60 g Pu/liter, CM: 747 gm, $H/^{239}Pu = 805$, 3.12 wt. % ^{240}Pu	1.00965	0.00089	0.00619	
pu004-10	35.36 g Pu/liter, CM: 836 gm, $H/^{239}Pu = 689$, 3.12 wt. % ^{240}Pu	1.00987	0.00092	0.00715	
pu004-11	39.38 g Pu/liter, CM: 931 gm, $H/^{239}Pu = 592$, 3.12 wt. % ^{240}Pu	1.0095	0.00092	0.00805	
pu004-12	29.44 g Pu/liter, CM: 696 gm, $H/^{239}Pu = 893$, 3.12 wt. % ^{240}Pu	1.01108	0.00087	0.00594	
pu004-13	29.27 g Pu/liter, CM: 692 gm, $H/^{239}Pu = 903$, 3.43 wt. % ^{240}Pu	1.00856	0.00091	0.00579	
Water Reflected 14-Inch Diameter Spheres, 0.050-in. thick shell of Stainless Steel Type 347 (NEA 1998, Volume I, PU-SOL-THERM-005, Sections 1, 2, and 3)					
pu005-1	29.65 g Pu/liter, CM: 701 gm, $H/^{239}Pu = 903$, 4.05 wt. % ^{240}Pu	1.0086	0.00088	0.00571	1a, 1b, 2a, 4a, 4b, 5a, 6a
pu005-2	30.54 g Pu/liter, CM: 722 gm, $H/^{239}Pu = 868$, 4.05 wt. % ^{240}Pu	1.00908	0.00088	0.00589	
pu005-3	31.43 g Pu/liter, CM: 743 gm, $H/^{239}Pu = 834$, 4.05 wt. % ^{240}Pu	1.01116	0.00091	0.0062	
pu005-4	33.54 g Pu/liter, CM: 793 gm, $H/^{239}Pu = 765$, 4.05 wt. % ^{240}Pu	1.01197	0.00093	0.00664	
pu005-5	36.04 g Pu/liter, CM: 852 gm, $H/^{239}Pu = 694$, 4.05 wt. % ^{240}Pu	1.01367	0.0009	0.00723	

Table III-22. Configurations Incorporating Plutonium Nitrate Solutions (Continued)

Exp ID	Description	k_{eff}^a	σ	AENCF (MeV)	CC	
pu005-6	38.49 g Pu/liter, CM: 910 gm, H/ ²³⁹ Pu = 633, 4.05 wt. % ²⁴⁰ Pu	1.0102	0.00095	0.00766		
pu005-7	40.91 g Pu/liter, CM: 967 gm, H/ ²³⁹ Pu = 581, 4.05 wt. % ²⁴⁰ Pu	1.01073	0.00094	0.00838		
pu005-8	30.58 g Pu/liter, CM: 723 gm, H/ ²³⁹ Pu = 869, 4.40 wt. % ²⁴⁰ Pu	1.00799	0.00091	0.00593		
pu005-9	31.85 g Pu/liter, CM: 753 gm, H/ ²³⁹ Pu = 825, 4.40 wt. % ²⁴⁰ Pu	1.01023	0.00089	0.00631		
Water Reflected Partly Filled 11.5-Inch Diameter Spheres, 0.049-in. thick shell of Stainless Steel Type 304L, 4.67 wt. % ²⁴⁰Pu, 95.059 wt. % ²³⁹Pu in Pu (NEA 1998, Volume I, PU-SOL-THERM-007, Sections 1, 2, and 3)						
pu007-2	232 g Pu/liter, Critical Volume: 12.35 liters, Height Above Sphere Center: 10.8373 cm, H/ ²³⁹ Pu = 110	1.01024	0.00102	0.04021	1a, 1b, 2a, 4a, 4b, 5a, 6a	
pu007-3	221 g Pu/liter, Critical Volume: 12.35 liters, Height Above Sphere Center: 10.8373 cm, H/ ²³⁹ Pu = 114	1.00591	0.00111	0.03928		
pu007-5	100.2 g Pu/liter, Critical Volume: 12.39 liters, Height Above Sphere Center: 10.9741 cm, H/ ²³⁹ Pu = 268	1.01502	0.00106	0.01764		
pu007-6	101.5 g Pu/liter, Critical Volume: 12.30 liters, Height Above Sphere Center: 10.6720 cm, H/ ²³⁹ Pu = 262	1.00873	0.00101	0.01799		
pu007-7	100.1 g Pu/liter, Critical Volume: 12.39 liters, Height Above Sphere Center: 10.9741 cm, H/ ²³⁹ Pu = 266	1.01053	0.00103	0.01783		
pu007-8	101.6 g Pu/liter, Critical Volume: 12.37 liters, Height Above Sphere Center: 10.9051 cm, H/ ²³⁹ Pu = 258	1.00254	0.00103	0.0181		
pu007-9	101.6 g Pu/liter, Critical Volume: 12.23 liters, Height Above Sphere Center: 10.4503 cm, H/ ²³⁹ Pu = 260	1.00327	0.00106	0.01815		
pu07-10	93.5 g Pu/liter, Critical Volume: 12.35 liters, Height Above Sphere Center: 10.8373 cm, H/ ²³⁹ Pu = 285	1.00706	0.00104	0.01653		
Unreflected 48-Inch Diameter Sphere, 0.303-inch thick shell of Type 1100 Aluminum, 97.386 wt. % ²³⁹Pu and 2.521 wt. % ²⁴⁰Pu in Pu (NEA 1998, Volume I, PU-SOL-THERM-009, Sections 1, 2, and 3)						
pust9-1	10.02 g Pu/liter, Critical Volume: 656.6 liters, Height Above Sphere Center: 15.9558 cm, H/ ²³⁹ Pu = 2648	1.01886	0.00088	0.00257		1a, 1b, 2a, 4a, 4b, 5a, 6a
pust9-2	9.539 g Pu/liter, Critical Volume: 906.5 liters, Height Above Sphere Center: 45.3705 cm, H/ ²³⁹ Pu = 2779	1.0239	0.00089	0.00266		
pust9-3	9.457 g Pu/liter, Critical Volume: 949.1 liters, Full Sphere, H/ ²³⁹ Pu = 2803	1.02176	0.00089	0.00246		

Table III-22. Configurations Incorporating Plutonium Nitrate Solutions (Continued)

Exp ID	Description	k_{eff}^a	σ	AENCF (MeV)	CC
Water Reflected Cylinders, 0.062-inch thick shell of Stainless Steel Type 347, 2.9 wt. % ^{240}Pu in Pu (NEA 1998, Volume I, PU-SOL-THERM-010, Sections 1, 2, and 3)					
pu10091	99.09 g Pu/liter, IR = 11.4264 cm, CH: 30.7086 cm, CM: 1249 g, $H/^{239}\text{Pu} = 267$	1.02337	0.00101	0.01675	1a, 1b, 2a, 4a, 4b, 5a, 6a
pu10092	73.92 g Pu/liter, IR = 11.4264 cm, CH: 35.4076 cm, CM: 1073 g, $H/^{239}\text{Pu} = 357$	1.02091	0.00097	0.01299	
pu10093	54.53 g Pu/liter, IR = 11.4264 cm, CH: 44.5770 cm, CM: 997 g, $H/^{239}\text{Pu} = 484$	1.01316	0.00097	0.00994	
pu10111	54.53 g Pu/liter, IR = 13.9684 cm, CH: 25.6032 cm, CM: 856 g, $H/^{239}\text{Pu} = 485$, Extra 0.065 inch layer of stainless steel placed around cylinder	1.01879	0.00099	0.01001	
pu10112	47.21 g Pu/liter, IR = 13.9684 cm, CH: 28.1686 cm, CM: 815 g, $H/^{239}\text{Pu} = 558$, Extra 0.065 inch layer of stainless steel placed around cylinder	1.01543	0.00098	0.00873	
pu10113	47.21 g Pu/liter, IR = 13.9684 cm, CH: 27.0764 cm, CM: 784 g, $H/^{239}\text{Pu} = 558$	1.01615	0.00092	0.00852	
pu10114	41.73 g Pu/liter, IR = 13.9684 cm, CH: 32.6390 cm, CM: 835 g, $H/^{239}\text{Pu} = 606$	1.00903	0.00091	0.0079	
pu10115	36.90 g Pu/liter, IR = 13.9684 cm, CH: 43.0022 cm, CM: 973 g, $H/^{239}\text{Pu} = 665$	1.01069	0.00093	0.00755	
pu10116	63.99 g Pu/liter, IR = 13.9684 cm, CH: 22.8092 cm, CM: 895 g, $H/^{239}\text{Pu} = 414$	1.01992	0.00101	0.01114	
pu10117	48.98 g Pu/liter, IR = 13.9684 cm, CH: 25.9588 cm, CM: 780 g, $H/^{239}\text{Pu} = 535$	1.01146	0.00092	0.00879	
pu10121	48.75 g Pu/liter, IR = 15.2390 cm, CH: 22.3520 cm, CM: 799 g, $H/^{239}\text{Pu} = 543$	1.0156	0.00097	0.00896	
pu10122	42.29 g Pu/liter, IR = 15.2390 cm, CH: 25.2476 cm, CM: 779 g, $H/^{239}\text{Pu} = 618$	1.01616	0.00095	0.00776	
pu10123	36.52 g Pu/liter, IR = 15.2390 cm, CH: 28.4734 cm, CM: 758 g, $H/^{239}\text{Pu} = 728$	1.02352	0.00094	0.00691	
pu10124	31.14 g Pu/liter, IR = 15.2390 cm, CH: 33.4264 cm, CM: 759 g, $H/^{239}\text{Pu} = 850$	1.01642	0.00087	0.0061	
Unreflected 16- & 18-Inch Diameter Spheres, 0.050-in. thick shell of Stainless Steel Type 347, 0.020-in. thick Cd Cover on the 18-inch sphere, 4.2 wt. % ^{240}Pu in Pu (NEA 1998, Volume I, PU-SOL-THERM-011, Sections 1, 2, and 3)					
pu11161	34.96 g Pu/liter, IR = 20.1206 cm, CM: 1194 g, $H/^{239}\text{Pu} = 765$	1.01661	0.00103	0.00738	1a, 1b, 2a, 4a, 4b, 5a, 6a
pu11162	36.22 g Pu/liter, IR = 20.1206 cm, CM: 1237 g, $H/^{239}\text{Pu} = 736$	1.02377	0.00101	0.00777	
pu11163	38.13 g Pu/liter, IR = 20.1206 cm, CM: 1302 g, $H/^{239}\text{Pu} = 691$	1.02224	0.00101	0.00827	
pu11164	38.16 g Pu/liter, IR = 20.1206 cm, CM: 1303 g, $H/^{239}\text{Pu} = 682$	1.01688	0.00105	0.00845	
pu11165	43.43 g Pu/liter, IR = 20.1206 cm, CM: 1483 g, $H/^{239}\text{Pu} = 575$	1.01338	0.00104	0.00973	
pu11181	22.35 g Pu/liter, IR = 22.6974 cm, CM: 1095 g, $H/^{239}\text{Pu} = 1208$	1.00169	0.00089	0.00505	

Table III-22. Configurations Incorporating Plutonium Nitrate Solutions (Continued)

Exp ID	Description	k_{eff}^a	σ	AENCF (MeV)	CC
pu11182	23.27 g Pu/liter, IR = 22.6974 cm, CM: 1140 g, H/ ²³⁹ Pu = 1151	1.0068	0.00088	0.00549	
pu11183	23.10 g Pu/liter, IR = 22.6974 cm, CM: 1132 g, H/ ²³⁹ Pu = 1158	1.00336	0.00097	0.00514	
pu11184	23.82 g Pu/liter, IR = 22.6974 cm, CM: 1167 g, H/ ²³⁹ Pu = 1100	1.00285	0.00088	0.00547	
pu11185	25.20 g Pu/liter, IR = 22.6974 cm, CM: 1235 g, H/ ²³⁹ Pu = 1039	1.01131	0.00093	0.00593	
pu11186	27.49 g Pu/liter, IR = 22.6974 cm, CM: 1347 g, H/ ²³⁹ Pu = 908	1.00796	0.00097	0.00633	
pu11187	23.94 g Pu/liter, IR = 22.6974 cm, CM: 1173 g, H/ ²³⁹ Pu = 1103	1.00792	0.00088	0.00548	

NOTES: ^a Calculated k_{eff} values for the Pu solution experiments which significantly exceed a value of 1.01 are often found when using the ENDF/B-V libraries. The most likely reason is that the Pu cross sections have a tendency to over-predict k_{eff} , but since the calculated values are over-predictions of a critical system, this is considered conservative with respect to criticality safety applications.

^b CH = Critical Height; CM = Critical Mass; IR = Internal Radius.

III.2.3.3 Low-Enrichment Uranium Solutions

The first set of experiments involving low-enrichment uranium is from *International Handbook of Evaluated Criticality Safety Benchmark Experiments* (NEA 1998, Volume IV); the second set (case prefix "LEUJ") is from work at the Japan Atomic Energy Research Institute (Miyoshi et al. 1997), and the third set (case prefix SPHU9) is cases that look at UO₃-H₂O critical solutions (Wittekind 1992). These experiments are listed in Table III-23.

Table III-23. Configurations Incorporating Low-Enrichment Uranium Solutions

Exp ID	Description	k_{eff}	σ	AENCF (MeV)	CC
174 Liter Spherical Tank of 4.9% Enriched UO₂F₂ Solutions, 34.399 cm Radius, 0.1588 cm thick 1100 Aluminum Shell (NEA 1998, Volume IV, LEU-SOL-THERM-002, Sections 1, 2, and 3)					
LEUST21	452.2 g U/liter, 22.11 g ²³⁵ U/liter, Water Reflector, Critical Volume: 170.5 Liters Critical Mass = 3769.8 g ²³⁵ U, H/ ²³⁵ U: 1098	0.99892	0.00053	0.02487	1a, 1b, 2a, 4a, 4b, 5a, 6a
LEUST22	491.7 g U/liter, 24.04 g ²³⁵ U/liter, No Reflector, Critical Volume: 172 Liters, Critical Mass = 4134.9 g ²³⁵ U, H/ ²³⁵ U: 1001	0.99469	0.00061	0.02832	
LEUST23	491.7 g U/liter, 24.04 g ²³⁵ U/liter, Water Reflector, Critical Volume = 145.6 Liters, Critical Mass = 3500.2 g ²³⁵ U, H/ ²³⁵ U: 1001	1.00078	0.00057	0.02665	

Table III-23. Configurations Incorporating Low-Enrichment Uranium Solutions (Continued)

Exp ID	Description	k_{eff}	σ	AENCF (MeV)	CC
Cylindrical Tank With a 59.0 cm ID, 0.3 cm thick Stainless Steel SS 304, ^{235}U Enrichment of 9.97 wt. % (Miyohsi et al. 1997)					
LEUJA01	310.1 g U/liter, 30.9 g ^{235}U /liter, Water Reflector, Critical Height: 41.53 cm, Critical Mass = 3508.4 g ^{235}U , H/ ^{235}U : 719.0, H/U: 72.5	1.00425	0.00085	0.01896	1a, 1b, 2a, 4a, 4b, 5a, 6a
LEUJA29	290.4 g U/liter, 29.0 g ^{235}U /liter, Water Reflector, Critical Height: 46.70 cm, Critical Mass = 3702.6 g ^{235}U , H/ ^{235}U : 771.3, H/U: 77.8	1.00377	0.00082	0.01806	
LEUJA33	270.0 g U/liter, 26.9 g ^{235}U /liter, Water Reflector, Critical Height: 52.93 cm, Critical Mass = 3892.7 g ^{235}U , H/ ^{235}U : 842.2, H/U: 84.9	0.99961	0.0009	0.01662	
LEUJA34	253.6 g U/liter, 25.3 g ^{235}U /liter, Water Reflector, Critical Height: 64.85 cm, Critical Mass = 4485.6 g ^{235}U , H/ ^{235}U : 895.8, H/U: 90.3	1.0029	0.00079	0.0159	
LEUJA46	241.9 g U/liter, 24.1 g ^{235}U /liter, Water Reflector, Critical Height: 78.56 cm, Critical Mass = 5176.2 g ^{235}U , H/ ^{235}U : 941.7, H/U: 95.0	1.00311	0.0008	0.01535	
LEUJA51	233.2 g U/liter, 23.3 g ^{235}U /liter, Water Reflector, Critical Height: 95.50 cm, Critical Mass = 6083.5 g ^{235}U , H/ ^{235}U : 982.5, H/U: 99.1	1.00279	0.0007	0.01479	
LEUJA54	225.3 g U/liter, 22.5 g ^{235}U /liter, Water Reflector, Critical Height: 130.33 cm, Critical Mass = 8017.2 g ^{235}U , H/ ^{235}U : 1017.5, H/U: 102.6	1.00246	0.00072	0.0144	
LEUJA14	313.0 g U/liter, 31.2 g ^{235}U /liter, No Reflector, Critical Height: 46.83 cm, Critical Mass = 3994.6 g ^{235}U , H/ ^{235}U : 709.2, H/U: 71.5	0.99755	0.00094	0.02001	
LEUJA30	290.7 g U/liter, 29.0 g ^{235}U /liter, No Reflector, Critical Height: 54.20 cm, Critical Mass = 4297.3 g ^{235}U , H/ ^{235}U : 770.0, H/U: 77.7	0.99885	0.00086	0.01881	
LEUJA32	270.0 g U/liter, 26.9 g ^{235}U /liter, No Reflector, Critical Height: 63.55 cm, Critical Mass = 4673.7 g ^{235}U , H/ ^{235}U : 842.2, H/U: 84.9	1.00143	0.00086	0.01757	
LEUJA36	253.9 g U/liter, 25.3 g ^{235}U /liter, No Reflector, Critical Height: 83.55 cm, Critical Mass = 5779.1 g ^{235}U , H/ ^{235}U : 896.0, H/U: 90.4	1.00185	0.00084	0.01665	
LEUJA49	241.9 g U/liter, 24.1 g ^{235}U /liter, No Reflector, Critical Height: 112.27 cm, Critical Mass = 7397.3 g ^{235}U , H/ ^{235}U : 942.2, H/U: 95.0	0.99875	0.00078	0.01593	
UO₃-H₂O Solution Experiments (Wittekind 1992, p. 43)					
SPHU9A	1.0059 wt. % enriched ^{235}U , H/ ^{235}U : 370.3, H/U: 3.772	0.9920a/ 0.99004b	0.0060c/ 0.00249d	0.2541	1a, 1b, 2a, 4a, 4b, 5a, 6a
SPHU9B	1.0059 wt. % enriched ^{235}U , H/ ^{235}U : 490.8, H/U: 4.999	0.9925/ 0.99269	0.0050/ 0.00249	0.2163	
SPHU9C	1.0059 wt. % enriched ^{235}U , H/ ^{235}U : 605.1, H/U: 6.164	0.9875/ 0.97871	0.0058/ 0.00256	0.1883	
SPHU9D	1.0059 wt. % enriched ^{235}U , H/ ^{235}U : 675.5, H/U: 6.881	0.9821/ 0.97914	0.0054/ 0.00242	0.1737	
SPHU9E	1.0059 wt. % enriched ^{235}U , H/ ^{235}U : 731.2, H/U: 7.449	0.9702/ 0.96607	0.0070/ 0.00163	0.1591	
SPHU9F	1.0704 wt. % enriched ^{235}U , H/ ^{235}U : 343.9, H/U: 3.728	1.0063/ 1.00952	0.0073/ 0.00261	0.2511	

Table III-23. Configurations Incorporating Low-Enrichment Uranium Solutions (Continued)

Exp ID	Description	k_{eff}	σ	AENCF (MeV)	CC
SPHU9G	1.0704 wt. % enriched ^{235}U , H/ ^{235}U : 533.1, H/U: 5.778	1.0064/ 1.0136	0.0078/ 0.00246	0.1839	
SPHU9H	1.0704 wt. % enriched ^{235}U , H/ ^{235}U : 652.7, H/U: 7.075	0.9957/ 0.99713	0.0061/ 0.00198	0.1651	
SPHU9I	1.1586 wt. % enriched ^{235}U , H/ ^{235}U : 317.7, H/U: 3.728	1.0298/ 1.03372	0.0056/ 0.00274	0.2495	
SPHU9J	1.1586 wt. % enriched ^{235}U , H/ ^{235}U : 475.6, H/U: 5.926	1.0330/ 1.04207	0.0051/ 0.00224	0.1783	
SPHU9K	1.1586 wt. % enriched ^{235}U , H/ ^{235}U : 582.8, H/U: 6.838	1.0313/ 1.02951	0.0032/ 0.00216	0.1661	
SPHU9L	1.1586 wt. % enriched ^{235}U , H/ ^{235}U : 634.9, H/U: 7.449	1.0209/ 1.02281	0.0051/ 0.0021	0.1549	

NOTES: ^a For the $\text{UO}_3\text{-H}_2\text{O}$ solution experiments the experimental determinations are the top numbers and were stated as k_∞ although the experiment was on a reflected sample (Wittekind 1992, p. 40).

^b For the $\text{UO}_3\text{-H}_2\text{O}$ solution experiments the calculated k_∞ value is the bottom number.

^c For the $\text{UO}_3\text{-H}_2\text{O}$ solution experiments the top number represents experimental uncertainty.

^d For the $\text{UO}_3\text{-H}_2\text{O}$ solution experiments the bottom number represents calculation uncertainty.

III.2.3.4 Low Enriched Uranyl Fluoride Solutions

This experiment involved an aqueous solution of about 5 weight percent enriched uranyl fluoride and is taken from *International Handbook of Evaluated Criticality Safety Benchmark Experiments* (NEA 1998, Volume IV, LEU-SOL-THERM-001, Sections 1, 2, and 3). This experiment used the Solution High Energy Burst Assembly-II, which is a critical assembly experiment that was operated at the Los Alamos Critical Experiments Facility. This experiment is listed in Table III-24.

Table III-24. Configurations Incorporating Uranyl Fluoride Solutions

Exp ID	Description	k_{eff}	σ	AENCF (MeV)	CC
Ist1-1	Average solution density: 2.1092 g/cm ³ , Average uranium density: 0.9783 g/cm ³ , Average ^{235}U enrichment: 4.9977 atom percent, H/X: 453.9	1.01069	0.00085	0.0523	1a, 1b, 2a, 4a, 4b, 5a, 6a

III.3 CRITICAL LIMIT COMPUTATION

The CL is derived from the bias and uncertainties associated with the criticality code and representation process. The CL for a configuration class is a limiting value of k_{eff} at which a configuration is considered potentially critical. The CL is characterized by statistical tolerance limits that account for biases and uncertainties associated with the criticality code trending process, and any uncertainties due to extrapolation outside the range of experimental data, or limitations in the geometrical or material representations used in the computational method.

III.3.1 Statistical Analyses

Evaluation of benchmark experiments that cover a wide range of parameters and configurations requires the determination of which groups of experiments can be statistically analyzed together and which should be analyzed separately. The benchmark experiments were grouped based on experimental similarity and are as follows:

- CRC Experiments
- Lattice LCEs (UO₂ and MOX based fuel)
- Uranium Solution LCEs
- Plutonium Solution LCEs.

The Student t-distribution (Walpole et al. 1998, pp. 228 to 232) is used to test the benchmark group results to determine if they can be analyzed together or not.

With the Student t-test for two groups it can be determined, with 95 percent confidence, whether subsets have different mean values and thus should not be analyzed together. The equality test requires computing the statistic “*T*” in Equation III-1.

$$T = \frac{\bar{Y}_1 - \bar{Y}_2}{\sqrt{\frac{(n-1)S_{y1}^2 + (m-1)S_{y2}^2}{n+m-2} \left(\frac{1}{n} + \frac{1}{m} \right)}} \quad (\text{Eq. III-1})$$

where

- \bar{Y}_1 = the calculated multiplication factor averages for subset 1
- \bar{Y}_2 = the calculated multiplication factor averages for subset 2
- n = the number of observations for subset 1
- m = the number of observations for subset 2
- S_{y1}^2 = the estimated variances for subset 1 (as shown in Equation III-2)
- S_{y2}^2 = the estimated variances for subset 2 (as shown in Equation III-3)

$$S_{y1}^2 = \frac{\sum_{i=1,n} (Y_i - \bar{Y}_1)^2}{n-1} \quad (\text{Eq. III-2})$$

$$S_{y2}^2 = \frac{\sum_{i=1,m} (Y_i - \bar{Y}_2)^2}{m-1} \quad (\text{Eq. III-3})$$

The “*T*” statistic is compared to the Student t-distribution with 95 percent confidence and n+m-2 degrees of freedom. The null hypothesis “the two subsets of data can be statistically combined (the mean values are approximately equal)” would be accepted if $|T| < t_{\alpha/2, n+m-2}$ and rejected otherwise where α is defined below. Table III-25 presents the test results.

Table III-25. Equality Test Statistic Results

Subsets	UO ₂ and MOX LCEs					
	Sample Size	Average k _{eff}	Variance	T statistic	t _{α/2,n+m-2} ^a	Combine?
UO ₂ LCEs	64	0.9985	2.282E-05	-1.2143	1.9897	Y
MOX LCEs	19	1.0000	2.777E-05			
CRCs and LCEs						
CRCs	60	0.9918	1.510E-05	-9.3984	1.9769	N
LCEs	83	0.9988	2.237E-05			
Uranium and Plutonium Solutions						
Uranium Solutions	28	1.0028	2.512E-04	-3.4257	1.9780	N
Plutonium Solutions	107	1.0094	3.942E-05			

NOTE: ^aα = 1-confidence level (i.e., 0.95).

III.3.2 Regression Analyses

The calculated multiplication factors for the benchmark experiments were trended against several parameters from each subset using a linear regression fit in order to determine whether a trend does exist and which parameters exhibit the strongest trends. A variation of the Student t-test along with the slope test was used to determine if a particular trend is considered statistically significant.

The linear regression fitted equation is in the form $y(x) = a + bx$. The slope test requires calculating the test statistic “*T*” as follows in Equation III-4 along with the statistical parameters in Equations III-5 and III-6.

$$T = b \sqrt{\frac{(n-2)S_{xx}}{SS_R}} \quad (\text{Eq. III-4})$$

where *b* comes from the fitted linear regression equation

$$S_{xx} = \sum_{i=1,n} (x_i - \bar{x})^2 \quad (\text{Eq. III-5})$$

and

$$SS_R = \sum_{i=1,n} (y_i - a - bx_i)^2 \quad (\text{Eq. III-6})$$

The test statistic is compared to the Student t-distribution ($t_{\alpha/2,n-2}$) with 95 percent confidence and *n*-2 degrees of freedom. Given a null hypothesis of “no statistically significant trend exists (slope is zero),” the hypothesis would be accepted if $|T| < t_{\alpha/2,n-2}$ and rejected otherwise. Unless the data is exceptional, the linear regression results will have a nonzero slope. By only accepting trends that the data supports with 95 percent confidence, trends due to the randomness of the data are eliminated.

III.3.3 Trending Evaluation

Trending against various parameters was performed in order to determine correlations between characteristics and the calculated multiplication factors for each subset. Depending on the type of benchmark, different trending parameters were evaluated in order to determine which exhibit the strongest trends. The regression statistics for the trend evaluations are presented in Tables III-26 to III-29 for each of the subsets and illustrated in Figures III-1 to III-12. The W/F term represents the unit cell moderator-to-fuel volume ratio. The P-value parameter gives a direct estimation of the probability of having linear trending due to chance only.

Table III-26. CRC Trending Parameter Results

Trend Parameter	N	Intercept	Slope	r ^{2a}	T	t _{w/2,n-2}	P-Value	Goodness-of-Fit Tests	Valid Trend
Core Avg. BU	60	0.9963	-0.0003	2.665	4.59	2.016	2.42E-05	Passed	Yes
AENCF	60	0.9892	0.0113	0.0095	0.74	2.016	0.4595	Failed	No

Source: Massie 2003, Section 6

NOTE: ^ar² is the correlation coefficient.

Table III-27. UO₂ and MOX LCE Trending Parameter Results

Trend Parameter	N	Slope	Intercept	S _{xx}	SS _R	r ^a	T	t _{w/2,n-2}	Trend?
AENCF	83	-6.336E-03	1.000E+00	1.941E-01	1.965E-03	0.063	-0.57	1.99	No
P/D	83	5.966E-03	9.890E-01	4.534E+00	1.811E-03	0.286	2.69	1.99	Yes
Pitch	83	6.723E-03	9.871E-01	5.687E+00	1.716E-03	0.361	3.48	1.99	Yes
W/F	83	1.156E-03	9.963E-01	1.238E+02	1.807E-03	0.290	2.72	1.99	Yes

NOTE: ^ar represents the r-value correlation coefficient (positive square root of squared correlation coefficient).

Table III-28. Uranium Solution Trending Parameter Results

Trend Parameter	N	Slope	Intercept	S _{xx}	SS _R	r	T	t _{w/2,n-2}	Trend?
AENCF	28	2.184E-02	1.001E+00	2.247E-01	6.676E-03	0.126	0.65	2.06	No
H/X	28	-2.199E-05	1.019E+00	1.343E+06	6.134E-03	0.309	-1.66	2.06	No
ALF ^a	28	-1.566E-03	1.011E+00	3.758E+01	6.691E-03	0.117	-0.60	2.06	No

NOTE: ^aALF is the average lethargy of a neutron causing fission.

Table III-29. Plutonium Solution Trending Parameter Results

Trend Parameter	N	Slope	Intercept	S _{xx}	SS _R	r	T	t _{w/2,n-2}	Trend?
AENCF	107	-2.545E-01	1.013E+00	1.976E-02	2.898E-03	0.554	-6.81	1.98	Yes
H/X	107	3.221E-06	1.007E+00	3.338E+07	3.832E-03	0.288	3.08	1.98	Yes
ALF	107	4.072E-03	9.817E-01	6.412E+01	3.115E-03	0.504	5.99	1.98	Yes

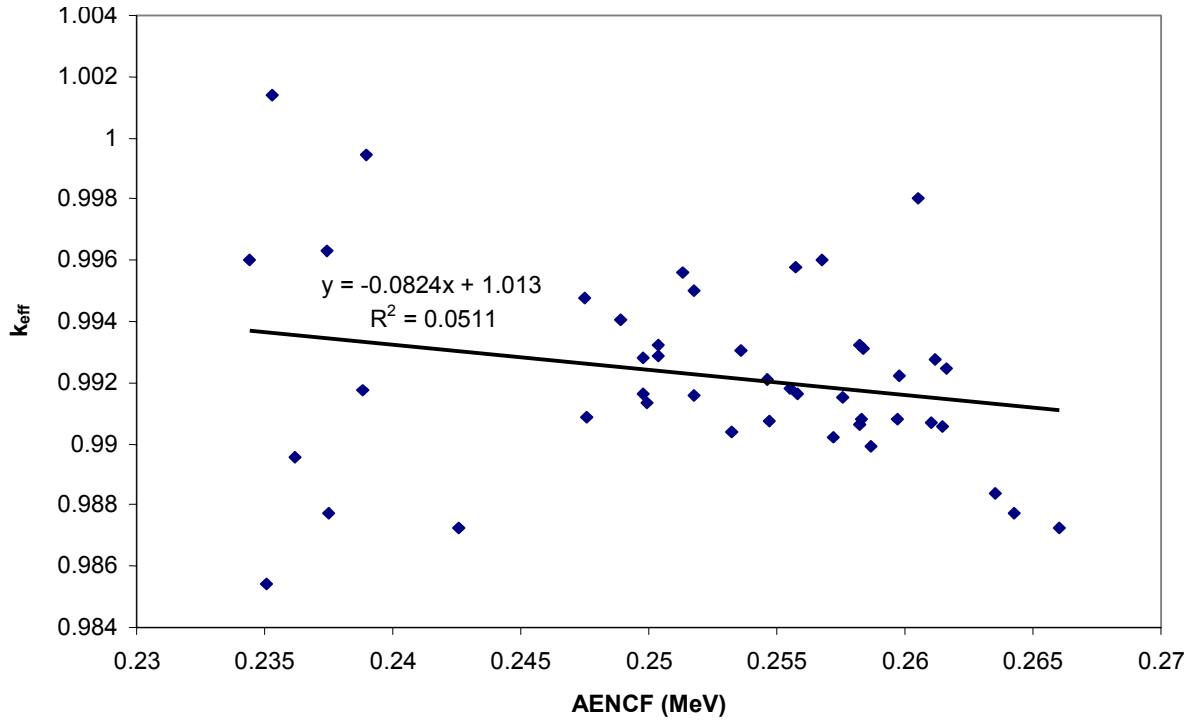

Figure III-1. CRC Subset with AENCF as Trending Parameter

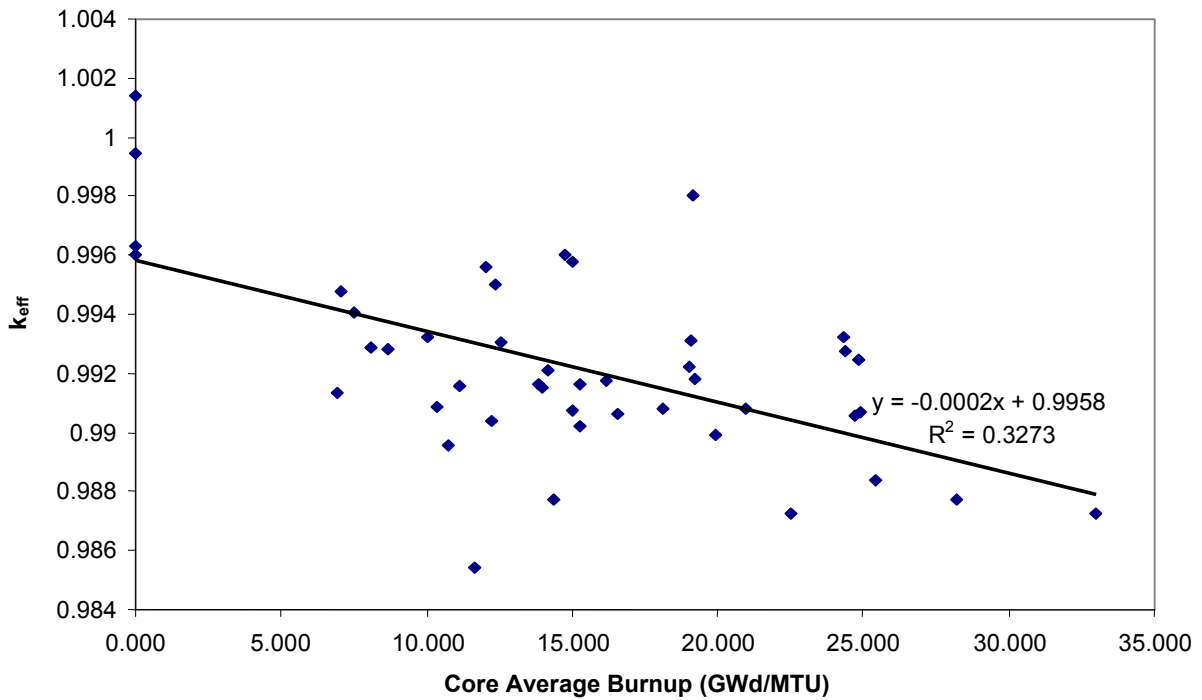

Figure III-2. CRC Subset with Core Average Burnup as Trending Parameter

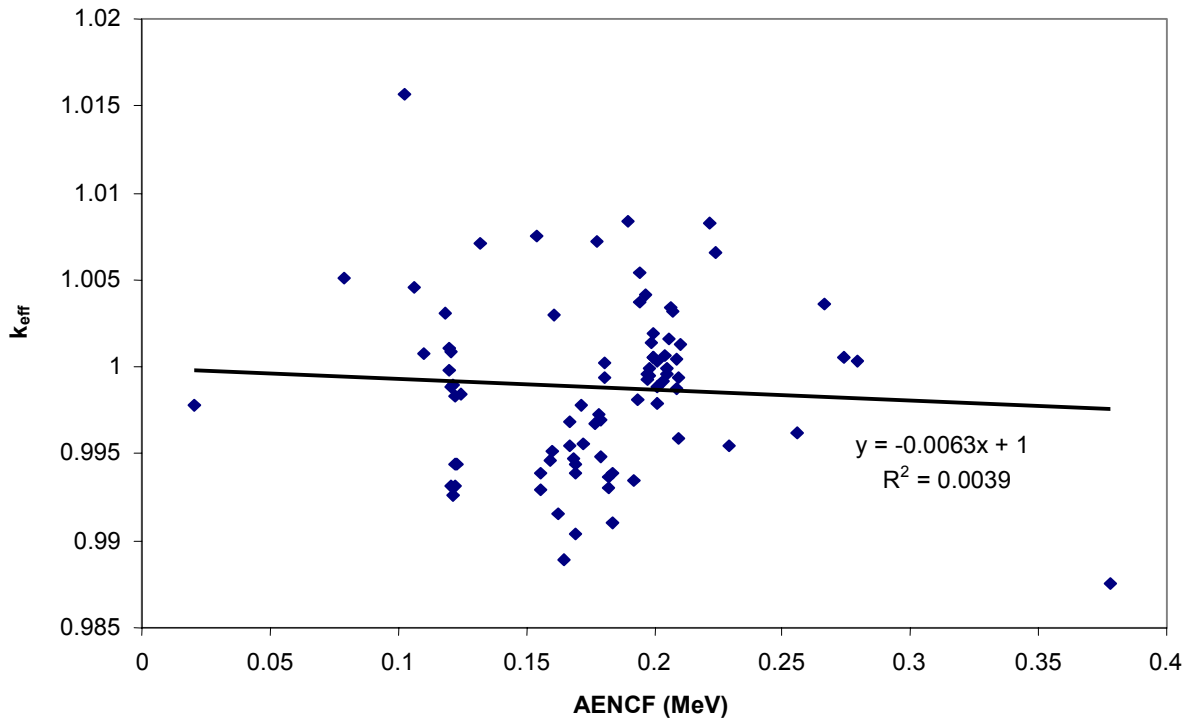

Figure III-3. UO₂ and MOX LCE Subset with AENCF as Trending Parameter

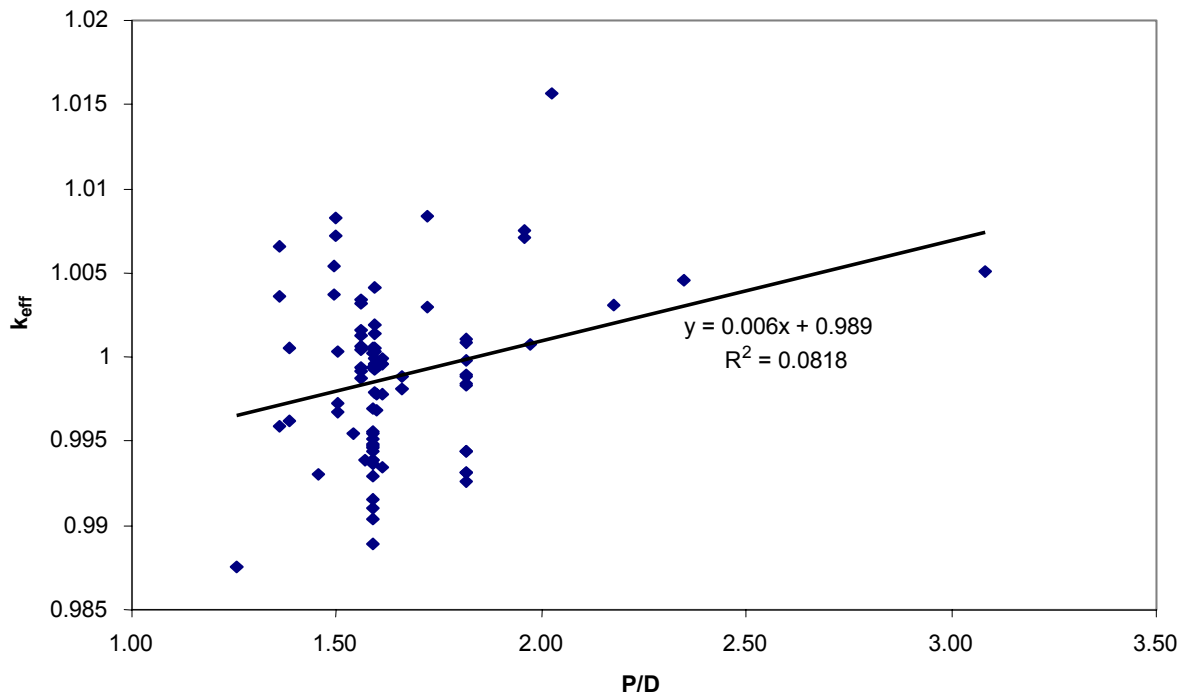

Figure III-4. UO₂ and MOX LCE Subset with P/D as Trending Parameter

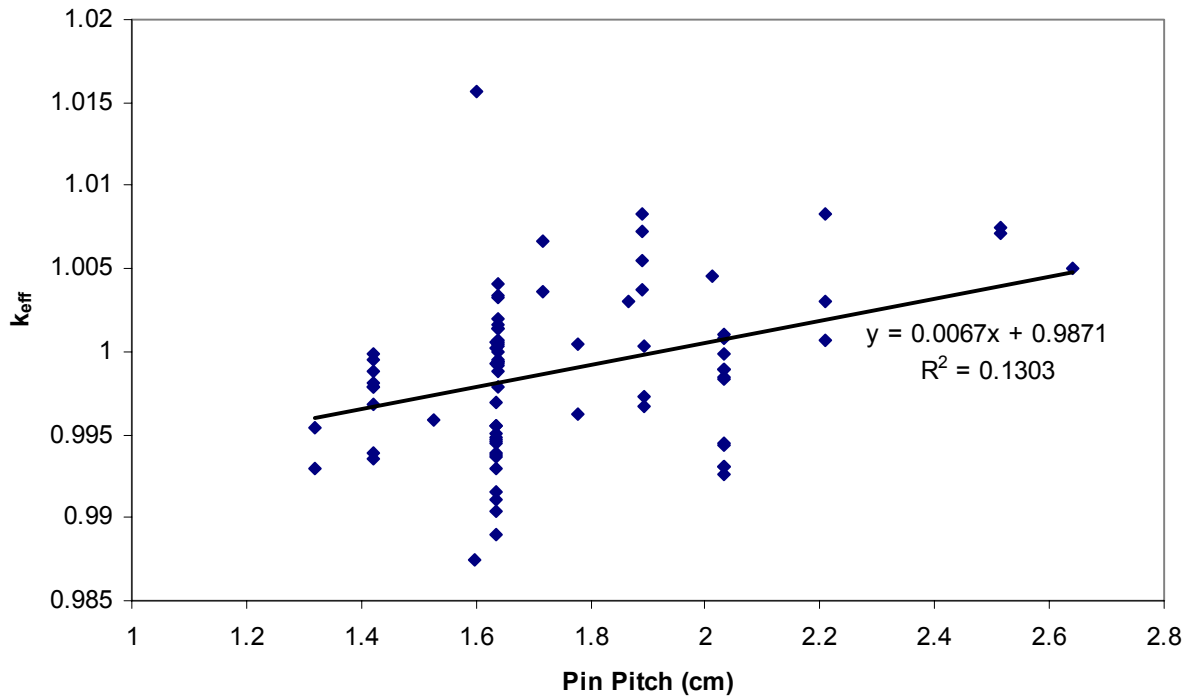

Figure III-5. UO₂ and MOX LCE Subset with Pin Pitch as Trending Parameter

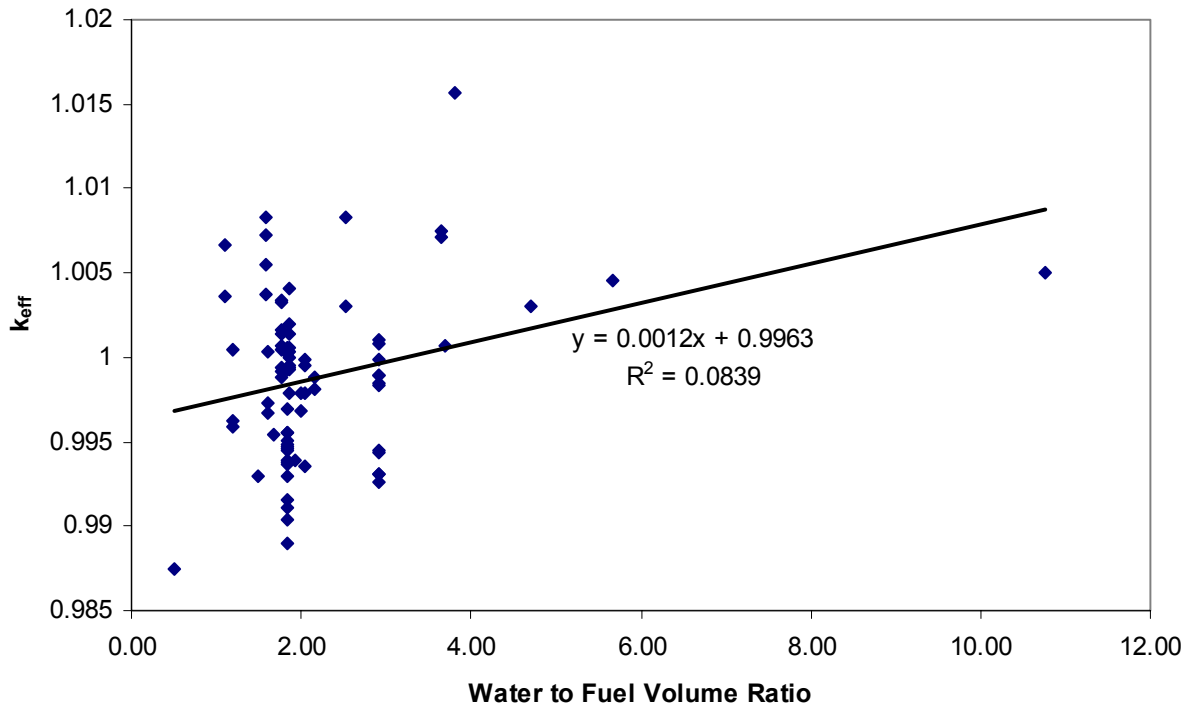

Figure III-6. UO₂ and MOX LCE Subset with Moderator-to-Fuel Volume Ratio as Trending Parameter

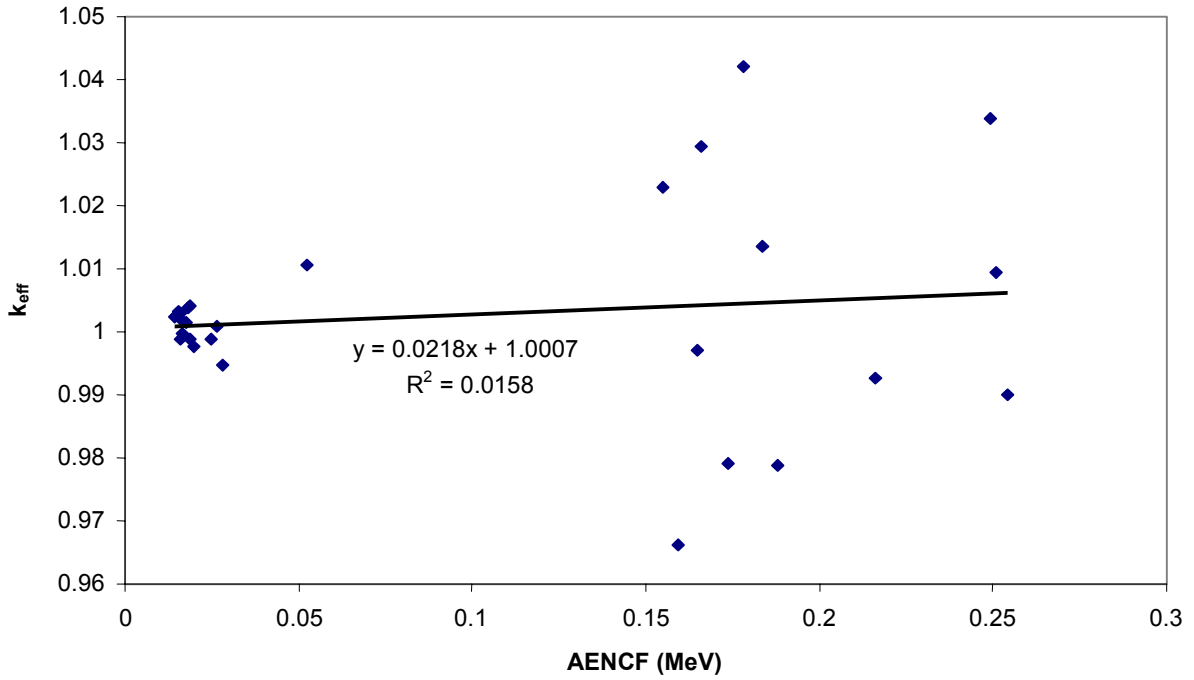

Figure III-7. Uranium Solution Subset with AENCF as Trending Parameter

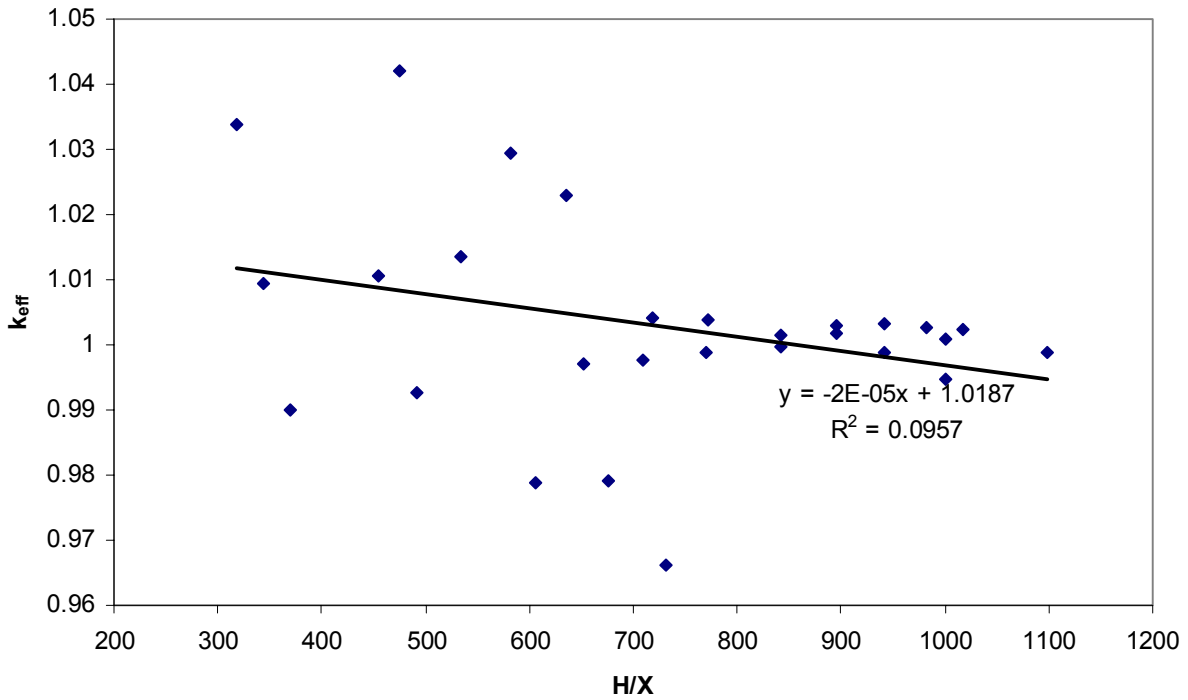

Figure III-8. Uranium Solution Subset with H/X as Trending Parameter

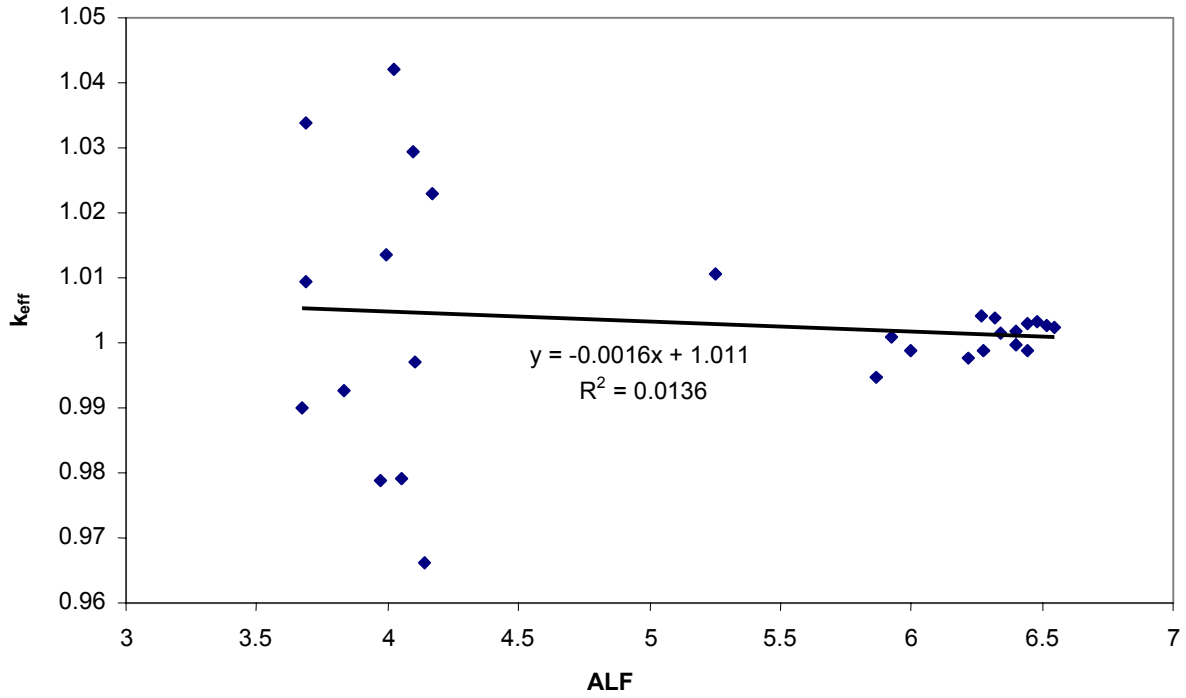

Figure III-9. Uranium Solution Subset with ALF as Trending Parameter

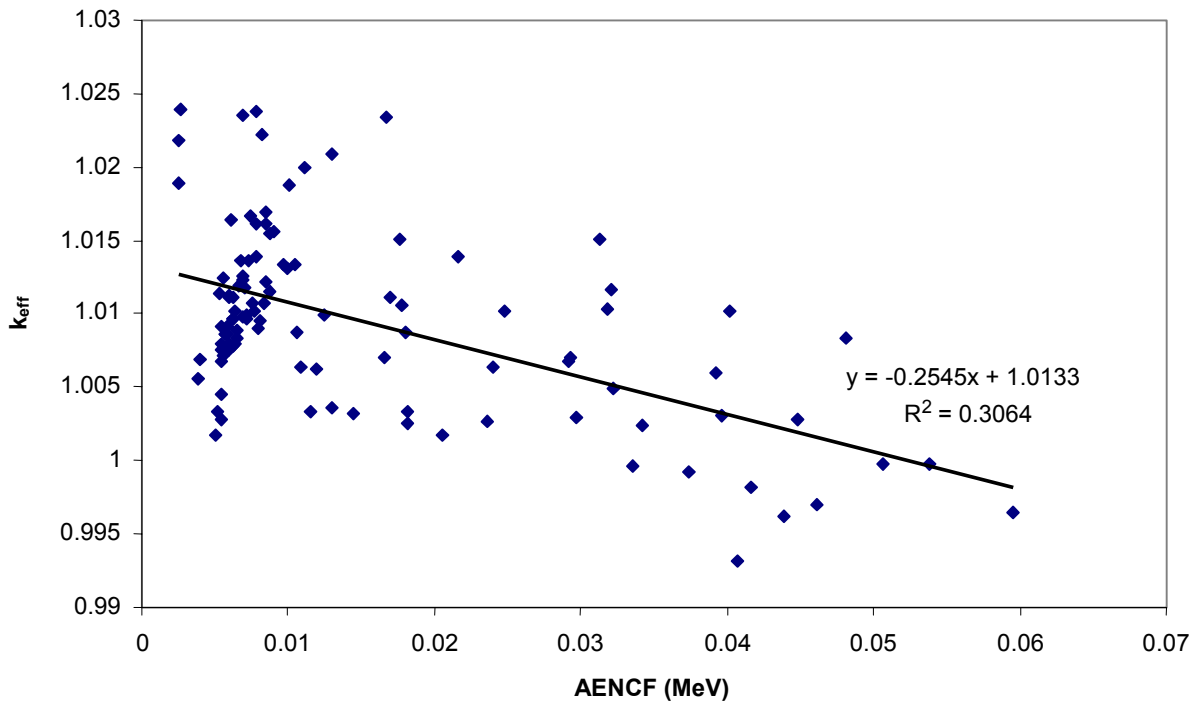

Figure III-10. Plutonium Solution Subset with AENCF as Trending Parameter

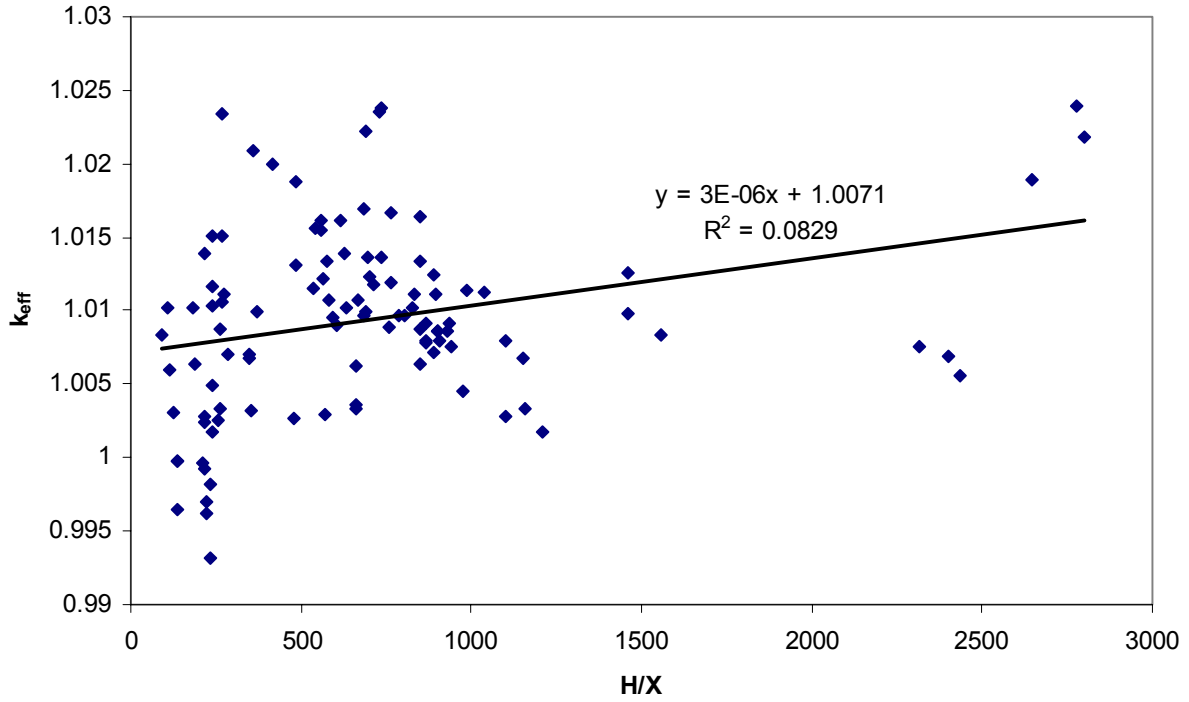

Figure III-11. Plutonium Solution Subset with H/X as Trending Parameter

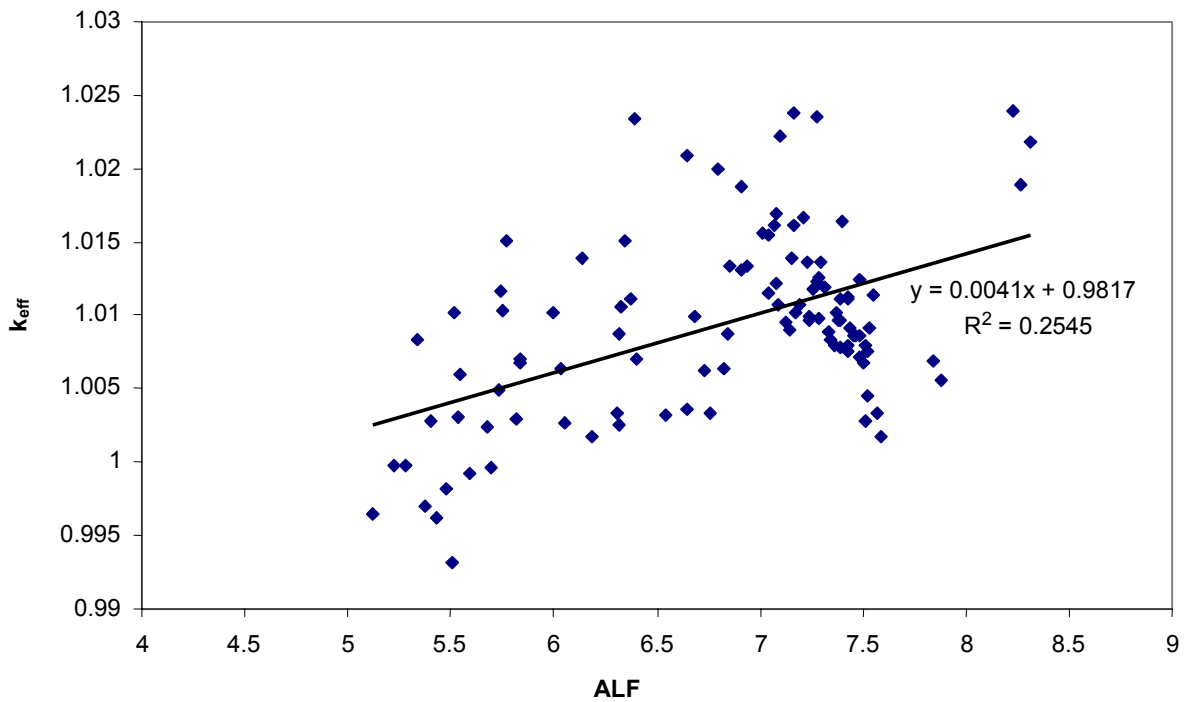

Figure III-12. Plutonium Solution Subset with ALF as Trending Parameter

III.3.4 Lower-Bound Tolerance Limit Determination

The LBTL is characterized by statistical tolerance limits that account for biases and uncertainties associated with the criticality code trending process. The LBTL is calculated by CLREG only when a trending regression is identified as statistically significant. If no trend is identified, the normal distribution tolerance limit (NDTL) or the distribution-free tolerance limit method is used as previously discussed in Section 6.1.1.3.

CLREG is a computer program that calculates sets of LBTL functions based on benchmark experiment results. Each LBTL represents the value of k_{eff} at which a configuration is considered potentially critical. This method accounts for the criticality analysis method bias and uncertainty of the calculated critical k_{eff} values for a set of critical experiments that represent the waste package, as explained by linear regression trending. A complete discussion of the statistical methodology for CLREG is provided in the CLREG documentation (BSC 2001c).

LBTLs were calculated for each subset of experiments for the parameter that had the most statistically significant trend. This is determined by which parameter has a correlation coefficient closest to one.

The selected LBTL values are presented in Table III-30 for each of the subsets. The CLREG results, as a function of the most statistically significant trending parameters, are provided in Tables III-31 for Lattice LCEs, Table III-32 for plutonium solutions, and in Massie (2003, Section 6.1) for CRCs. The CLREG results are illustrated in Figures III-13 to III-15. The results presented in Table III-30 were generated for a 95 percent confidence level covering 99.5 percent of the population. For the UO₂ solution experiments, Figures III-16 and III-17 show that the data set appears to be normally distributed therefore the NDTL method was used for calculating the LBTL.

Table III-30. Lower-Bound Tolerance Limits for Experiment Subsets

Subset	Trend Parameter	Lower-Bound Tolerance Limit
CRCs ^a	Core Average Burnup (BU)	$f(BU) = -0.0003 \times BU + 0.9866$ ($0 < BU < 33$ Gwd/MTU) ^c
Lattice LCEs ^b	Pin Pitch (P)	$f(P) = 7.0175E-03 \times P + 0.9677$ ($1.32 \text{ cm} \leq P \leq 1.89 \text{ cm}$); $f(P) = 0.982$ ($1.89 \text{ cm} < P \leq 2.64 \text{ cm}$) ^c
UO ₂ Solutions ^b	None	$f(x) = 0.952^d$
Plutonium Solutions ^b	AENCF	$f(AENCF) = 0.980$ ($2.46E-03 \text{ MeV} \leq AENCF \leq 5.96E-02 \text{ MeV}$)

Source: ^a Massie 2003, Section 6.1

^b Calculated in current analysis

NOTES: ^c Upper limit set at 0.982 since no positive bias credit is taken.

^d Calculated using the NDTL method with 95 percent confidence level covering 99.5 percent of the population.

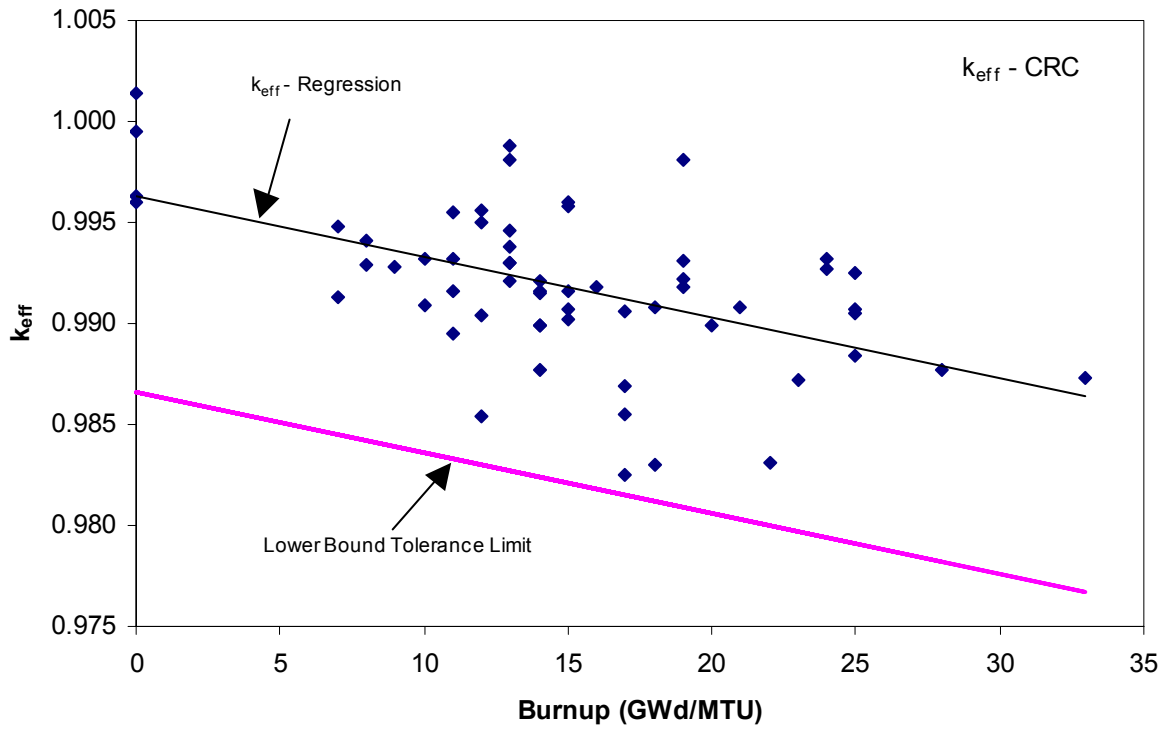

Figure III-13. Lower-Bound Tolerance Limit Plot for CRC Experiment Subset

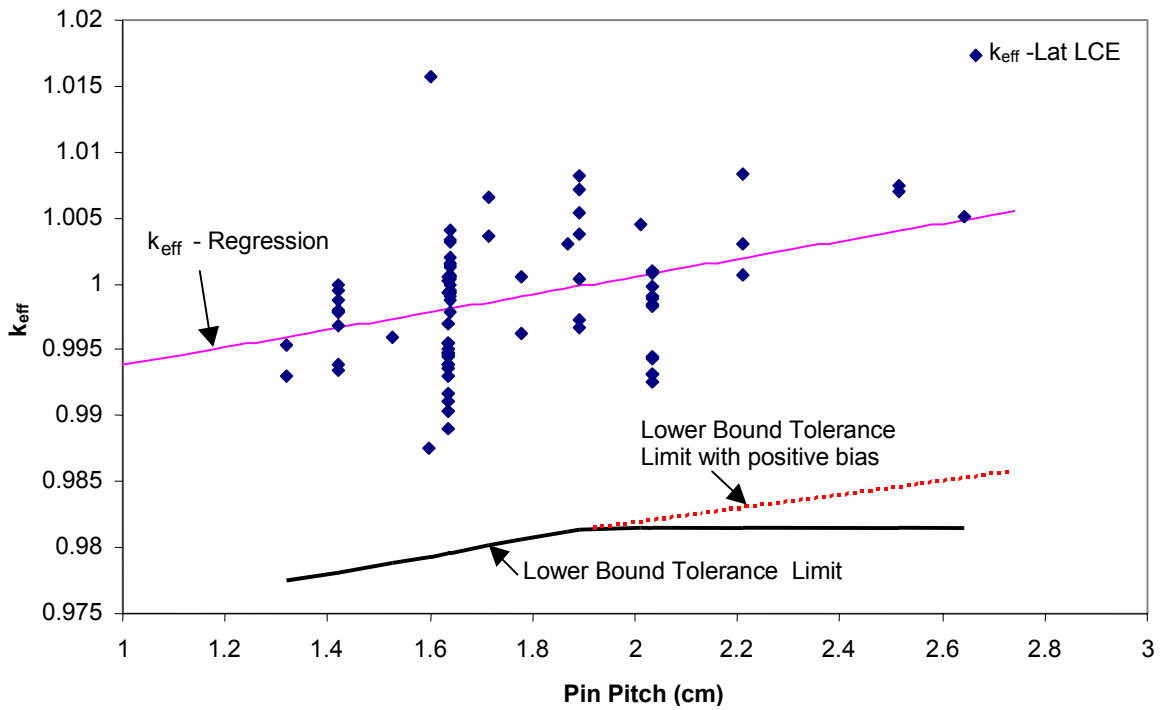

Figure III-14. Lower-Bound Tolerance Limit Plot for Lattice LCE Subset

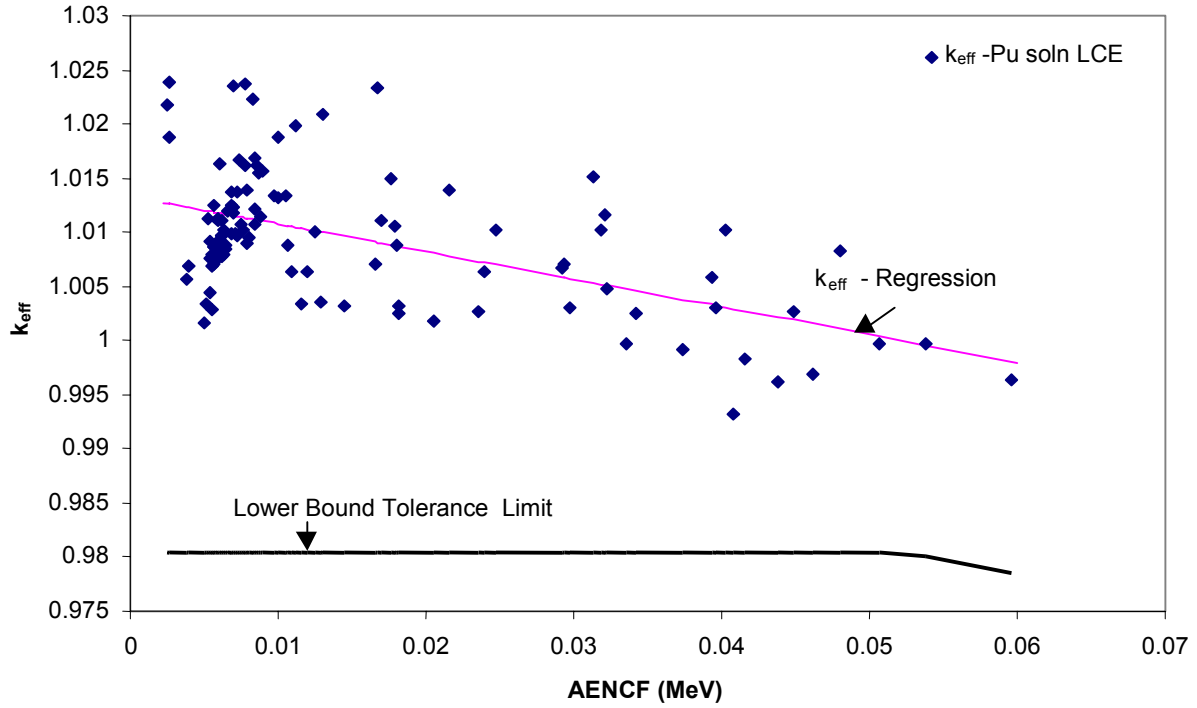

Figure III-15. Lower-Bound Tolerance Limit Plot for Plutonium Solution LCE Subset

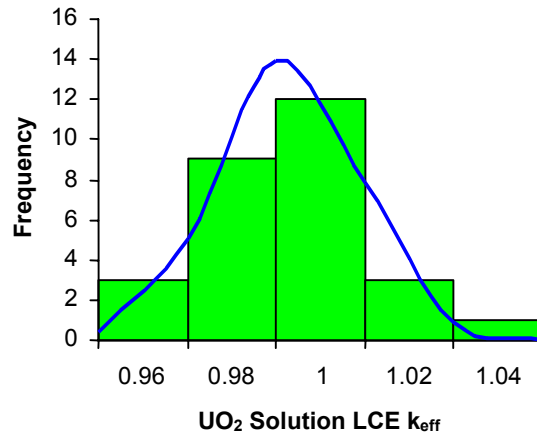

Figure III-16. Histogram Plot for UO_2 Solution LCE k_{eff} Values

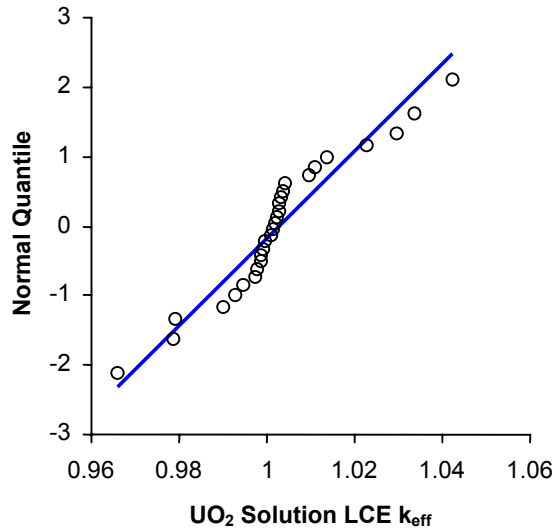

Figure III-17. Normal Quantile Plot for UO₂ Solution LCE k_{eff} Values

Table III-31. Lattice LCEs with Pitch as Trend Parameter^a

Ind Var	$K_{eff}(cc)$	Pred K_{eff}	PreClos CL	LUTB CL	Bonf LTL
1.32E+00	0.993	0.996	0.987	0.977	0.977
1.32E+00	0.995	0.996	0.987	0.977	0.977
1.42E+00	0.994	0.997	0.988	0.978	0.977
1.42E+00	0.998	0.997	0.988	0.978	0.977
1.42E+00	0.998	0.997	0.988	0.978	0.977
1.42E+00	0.999	0.997	0.988	0.978	0.977
1.42E+00	1.000	0.997	0.988	0.978	0.977
1.42E+00	0.997	0.997	0.988	0.978	0.977
1.42E+00	0.993	0.997	0.988	0.978	0.977
1.42E+00	0.998	0.997	0.988	0.978	0.977
1.42E+00	1.000	0.997	0.988	0.978	0.977
1.53E+00	0.996	0.997	0.989	0.979	0.978
1.60E+00	0.988	0.998	0.989	0.979	0.978
1.60E+00	1.016	0.998	0.989	0.979	0.978
1.64E+00	0.995	0.998	0.990	0.980	0.979
1.64E+00	0.996	0.998	0.990	0.980	0.979
1.64E+00	0.994	0.998	0.990	0.980	0.979
1.64E+00	0.995	0.998	0.990	0.980	0.979
1.64E+00	1.000	0.998	0.990	0.980	0.979
1.64E+00	1.001	0.998	0.990	0.980	0.979
1.64E+00	0.989	0.998	0.990	0.980	0.979
1.64E+00	0.993	0.998	0.990	0.980	0.979
1.64E+00	0.995	0.998	0.990	0.980	0.979

Table III-31. Lattice LCEs with Pitch as Trend Parameter^a (Continued)

Ind Var	K _{eff} (cc)	Pred K _{eff}	PreClos CL	LUTB CL	Bonf LTL
1.64E+00	0.997	0.998	0.990	0.980	0.979
1.64E+00	0.995	0.998	0.990	0.980	0.979
1.64E+00	0.999	0.998	0.990	0.980	0.979
1.64E+00	0.991	0.998	0.990	0.980	0.979
1.64E+00	0.990	0.998	0.990	0.980	0.979
1.64E+00	0.994	0.998	0.990	0.980	0.979
1.64E+00	0.995	0.998	0.990	0.980	0.979
1.64E+00	0.994	0.998	0.990	0.980	0.979
1.64E+00	0.994	0.998	0.990	0.980	0.979
1.64E+00	0.992	0.998	0.990	0.980	0.979
1.64E+00	0.998	0.998	0.990	0.980	0.979
1.64E+00	0.999	0.998	0.990	0.980	0.979
1.64E+00	1.000	0.998	0.990	0.980	0.979
1.64E+00	1.001	0.998	0.990	0.980	0.979
1.64E+00	1.002	0.998	0.990	0.980	0.979
1.64E+00	1.003	0.998	0.990	0.980	0.979
1.64E+00	0.999	0.998	0.990	0.980	0.979
1.64E+00	0.999	0.998	0.990	0.980	0.979
1.64E+00	1.001	0.998	0.990	0.980	0.979
1.64E+00	1.003	0.998	0.990	0.980	0.979
1.64E+00	1.001	0.998	0.990	0.980	0.979
1.64E+00	0.999	0.998	0.990	0.980	0.979
1.64E+00	1.004	0.998	0.990	0.980	0.979
1.64E+00	1.000	0.998	0.990	0.980	0.979
1.64E+00	1.000	0.998	0.990	0.980	0.979
1.64E+00	1.000	0.998	0.990	0.980	0.979
1.64E+00	1.002	0.998	0.990	0.980	0.979
1.64E+00	1.001	0.998	0.990	0.980	0.979
1.64E+00	0.999	0.998	0.990	0.980	0.979
1.72E+00	1.007	0.999	0.990	0.980	0.979
1.72E+00	1.004	0.999	0.990	0.980	0.979
1.78E+00	1.001	0.999	0.990	0.981	0.980
1.78E+00	0.996	0.999	0.990	0.981	0.980
1.87E+00	1.003	1.000	0.991	0.981	0.980
1.89E+00	1.008	1.000	0.991	0.981	0.980
1.89E+00	1.007	1.000	0.991	0.981	0.980
1.89E+00	1.005	1.000	0.991	0.981	0.980
1.89E+00	1.004	1.000	0.991	0.981	0.980
1.89E+00	0.997	1.000	0.991	0.981	0.980
1.89E+00	0.997	1.000	0.991	0.981	0.980
1.89E+00	1.000	1.000	0.991	0.981	0.980
2.01E+00	1.005	1.001	0.991	0.982	0.981

Table III-31. Lattice LCEs with Pitch as Trend Parameter^a (Continued)

Ind Var	K _{eff} (cc)	Pred K _{eff}	PreClos CL	LUTB CL	Bonf LTL
2.03E+00	0.998	1.001	0.991	0.982	0.981
2.03E+00	0.993	1.001	0.991	0.982	0.981
2.03E+00	1.001	1.001	0.991	0.982	0.981
2.03E+00	0.993	1.001	0.991	0.982	0.981
2.03E+00	0.993	1.001	0.991	0.982	0.981
2.03E+00	1.000	1.001	0.991	0.982	0.981
2.03E+00	0.994	1.001	0.991	0.982	0.981
2.03E+00	0.994	1.001	0.991	0.982	0.981
2.03E+00	1.001	1.001	0.991	0.982	0.981
2.03E+00	0.999	1.001	0.991	0.982	0.981
2.03E+00	0.998	1.001	0.991	0.982	0.981
2.03E+00	0.999	1.001	0.991	0.982	0.981
2.21E+00	1.001	1.002	0.991	0.982	0.981
2.21E+00	1.003	1.002	0.991	0.982	0.981
2.21E+00	1.008	1.002	0.991	0.982	0.981
2.52E+00	1.007	1.004	0.991	0.982	0.981
2.52E+00	1.008	1.004	0.991	0.982	0.981
2.64E+00	1.005	1.005	0.991	0.982	0.981

NOTES: ^a Descriptions of the meanings of the values in each column can be obtained from CLREG Documentation (BSC 2001c).

Table III-32. Plutonium Solution Experiments with AENCF as Trend Parameter^a

Ind Var	K _{eff} (cc)	Pred K _{eff}	PreClos CL	LUTB CL	Bonf LTL
2.46E-03	1.022	1.013	0.991	0.980	0.980
2.57E-03	1.019	1.013	0.991	0.980	0.980
2.66E-03	1.024	1.013	0.991	0.980	0.980
3.80E-03	1.006	1.012	0.991	0.980	0.980
3.93E-03	1.007	1.012	0.991	0.980	0.980
5.05E-03	1.002	1.012	0.991	0.980	0.980
5.14E-03	1.003	1.012	0.991	0.980	0.980
5.24E-03	1.011	1.012	0.991	0.980	0.980
5.38E-03	1.009	1.012	0.991	0.980	0.980
5.41E-03	1.004	1.012	0.991	0.980	0.980
5.43E-03	1.008	1.012	0.991	0.980	0.980
5.47E-03	1.003	1.012	0.991	0.980	0.980
5.48E-03	1.008	1.012	0.991	0.980	0.980
5.49E-03	1.007	1.012	0.991	0.980	0.980
5.60E-03	1.012	1.012	0.991	0.980	0.980
5.61E-03	1.007	1.012	0.991	0.980	0.980
5.64E-03	1.009	1.012	0.991	0.980	0.980
5.71E-03	1.009	1.012	0.991	0.980	0.980
5.79E-03	1.009	1.012	0.991	0.980	0.980
5.89E-03	1.009	1.012	0.991	0.980	0.980

Table III-32. Plutonium Solution Experiments with AENCF as Trend Parameter^a (Continued)

Ind Var	K _{eff} (cc)	Pred K _{eff}	PreClos CL	LUTB CL	Bonf LTL
5.93E-03	1.011	1.012	0.991	0.980	0.980
5.93E-03	1.008	1.012	0.991	0.980	0.980
5.94E-03	1.011	1.012	0.991	0.980	0.980
5.97E-03	1.008	1.012	0.991	0.980	0.980
6.10E-03	1.016	1.012	0.991	0.980	0.980
6.19E-03	1.010	1.012	0.991	0.980	0.980
6.20E-03	1.011	1.012	0.991	0.980	0.980
6.20E-03	1.008	1.012	0.991	0.980	0.980
6.23E-03	1.010	1.012	0.991	0.980	0.980
6.31E-03	1.010	1.012	0.991	0.980	0.980
6.33E-03	1.008	1.012	0.991	0.980	0.980
6.48E-03	1.008	1.012	0.991	0.980	0.980
6.51E-03	1.009	1.012	0.991	0.980	0.980
6.64E-03	1.012	1.012	0.991	0.980	0.980
6.78E-03	1.014	1.012	0.991	0.980	0.980
6.84E-03	1.010	1.012	0.991	0.980	0.980
6.84E-03	1.013	1.012	0.991	0.980	0.980
6.91E-03	1.024	1.012	0.991	0.980	0.980
6.93E-03	1.012	1.012	0.991	0.980	0.980
7.03E-03	1.012	1.012	0.991	0.980	0.980
7.15E-03	1.010	1.011	0.991	0.980	0.980
7.20E-03	1.010	1.011	0.991	0.980	0.980
7.23E-03	1.014	1.011	0.991	0.980	0.980
7.38E-03	1.017	1.011	0.991	0.980	0.980
7.55E-03	1.011	1.011	0.991	0.980	0.980
7.66E-03	1.010	1.011	0.991	0.980	0.980
7.76E-03	1.016	1.011	0.991	0.980	0.980
7.77E-03	1.024	1.011	0.991	0.980	0.980
7.85E-03	1.014	1.011	0.991	0.980	0.980
7.90E-03	1.009	1.011	0.991	0.980	0.980
8.05E-03	1.010	1.011	0.991	0.980	0.980
8.27E-03	1.022	1.011	0.991	0.980	0.980
8.38E-03	1.011	1.011	0.991	0.980	0.980
8.45E-03	1.017	1.011	0.991	0.980	0.980
8.45E-03	1.012	1.011	0.991	0.980	0.980
8.52E-03	1.016	1.011	0.991	0.980	0.980
8.73E-03	1.015	1.011	0.991	0.980	0.980
8.79E-03	1.011	1.011	0.991	0.980	0.980
8.96E-03	1.016	1.011	0.991	0.980	0.980
9.73E-03	1.013	1.011	0.991	0.980	0.980
9.94E-03	1.013	1.011	0.991	0.980	0.980
1.00E-02	1.019	1.011	0.991	0.980	0.980
1.05E-02	1.013	1.011	0.991	0.980	0.980
1.06E-02	1.009	1.011	0.991	0.980	0.980

Table III-32. Plutonium Solution Experiments with AENCF as Trend Parameter^a (Continued)

Ind Var	K _{eff} (cc)	Pred K _{eff}	PreClos CL	LUTB CL	Bonf LTL
1.09E-02	1.006	1.011	0.991	0.980	0.980
1.11E-02	1.020	1.010	0.991	0.980	0.980
1.16E-02	1.003	1.010	0.991	0.980	0.980
1.20E-02	1.006	1.010	0.991	0.980	0.980
1.25E-02	1.010	1.010	0.991	0.980	0.980
1.30E-02	1.004	1.010	0.991	0.980	0.980
1.30E-02	1.021	1.010	0.991	0.980	0.980
1.45E-02	1.003	1.010	0.991	0.980	0.980
1.65E-02	1.007	1.009	0.991	0.980	0.980
1.68E-02	1.023	1.009	0.991	0.980	0.980
1.70E-02	1.011	1.009	0.991	0.980	0.980
1.76E-02	1.015	1.009	0.991	0.980	0.980
1.78E-02	1.011	1.009	0.991	0.980	0.980
1.80E-02	1.009	1.009	0.991	0.980	0.980
1.81E-02	1.003	1.009	0.991	0.980	0.980
1.82E-02	1.003	1.009	0.991	0.980	0.980
2.06E-02	1.002	1.008	0.991	0.980	0.980
2.16E-02	1.014	1.008	0.991	0.980	0.980
2.36E-02	1.003	1.007	0.991	0.980	0.980
2.40E-02	1.006	1.007	0.991	0.980	0.980
2.48E-02	1.010	1.007	0.991	0.980	0.980
2.92E-02	1.007	1.006	0.991	0.980	0.980
2.93E-02	1.007	1.006	0.991	0.980	0.980
2.97E-02	1.003	1.006	0.991	0.980	0.980
3.13E-02	1.015	1.005	0.991	0.980	0.980
3.18E-02	1.010	1.005	0.991	0.980	0.980
3.21E-02	1.012	1.005	0.991	0.980	0.980
3.23E-02	1.005	1.005	0.991	0.980	0.980
3.36E-02	1.000	1.005	0.991	0.980	0.980
3.42E-02	1.002	1.005	0.991	0.980	0.980
3.74E-02	0.999	1.004	0.991	0.980	0.980
3.93E-02	1.006	1.003	0.991	0.980	0.980
3.97E-02	1.003	1.003	0.991	0.980	0.980
4.02E-02	1.010	1.003	0.991	0.980	0.980
4.08E-02	0.993	1.003	0.991	0.980	0.980
4.16E-02	0.998	1.003	0.991	0.980	0.980
4.39E-02	0.996	1.002	0.991	0.980	0.980
4.48E-02	1.003	1.002	0.991	0.980	0.980
4.61E-02	0.997	1.002	0.991	0.980	0.980
4.81E-02	1.008	1.001	0.991	0.980	0.980
5.07E-02	1.000	1.000	0.991	0.980	0.980
5.39E-02	1.000	1.000	0.990	0.980	0.979
5.96E-02	0.996	0.998	0.989	0.979	0.978

NOTES: ^aDescriptions of the meanings of the values in each column can be obtained from CLREG Documentation (BSC 2001c).

III.3.5 Range of Applicability

When evaluating biases and uncertainties and choosing parameters (or areas) for which a bias would exhibit a trend, there are three fundamental areas (Lichtenwalter et al. 1997, p. 179) that should be considered:

1. Materials of the waste package and the waste form, especially the fissionable materials
2. The geometry of the waste package and waste forms
3. The inherent neutron energy spectrum affecting the fissionable materials.

In this case, the application is for four experiment subsets representative of a waste package in various forms of degradation as defined by the Master Scenarios (YMP 2003, Figures 3-2a and -2b).

Important areas for evaluating criticality are the geometry of the configuration, the concentration of important materials (reflecting materials, moderating materials, fissionable materials, and significant neutron absorbing materials), and the nuclear cross sections that characterize the nuclear reaction rates that will occur in a system containing fissionable and absorbing materials.

In a light-water moderated and reflected environment with fuel rods arranged in a lattice configuration, the neutronic behavior (spectra) is expected to be fairly constant in terms of relative distribution regardless of the surrounding environment. Differences in neutron spectra between the various configurations are expected to occur as a result of factors including H/X ratio, material differences, and moderator temperature differences.

Figure III-18 illustrates the neutron flux spectral characteristics that were compared for a representative 21 PWR waste package (WP in Figure III-20), a PWR CRC statepoint, two MOX LCEs—SSR53 (12×12 PuO₂ lattice) and EXP22 (12×12 PuO₂ Lattice), and one fresh fuel LCE (SSR48 UO₂ lattice). The MCNP input and output files used to generate the spectral tallies are listed in Attachment I but contained in Attachment II.

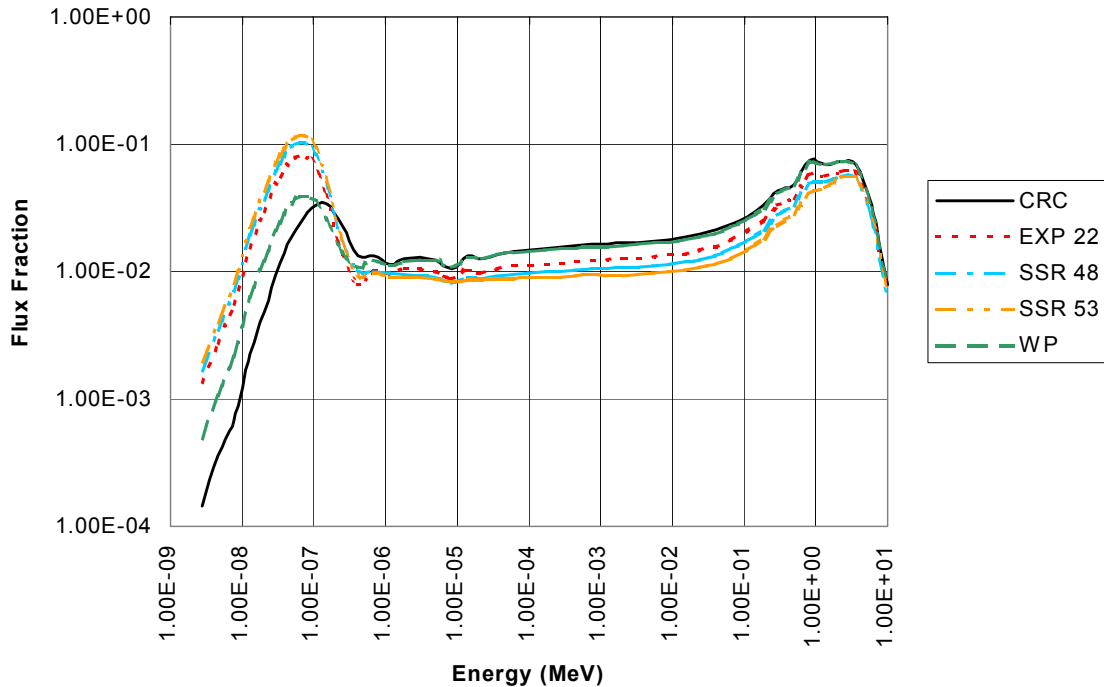

Figure III-18. Neutron Energy Spectra of Waste Package and Critical Benchmarks

The commercial reactor used for the CRC data was the Crystal River Unit 3 PWR with statepoint data corresponding to a mid-cycle restart, performed 400 EFPD into Cycle 6. A fuel assembly arrangement in the CRC was represented as shown in Figure III-19. A 21-assembly area of the core was represented in a fully flooded, intact waste package configuration as shown in Figure III-19. The waste package representation was loaded with a grouping of 21 assemblies out of the CRC statepoint to remove material composition differences from the comparison. The burned fuel assemblies represented in the waste package varied in average assembly burnup from 16.4 through 34.4 GWd/MTU and initial enrichments of 2.64 through 3.49 weight percent ^{235}U . Each of the irradiated fuel assemblies was represented explicitly with 18 axial nodes in both the CRC and in the waste package and was depleted through each of their own unique operating history profiles.

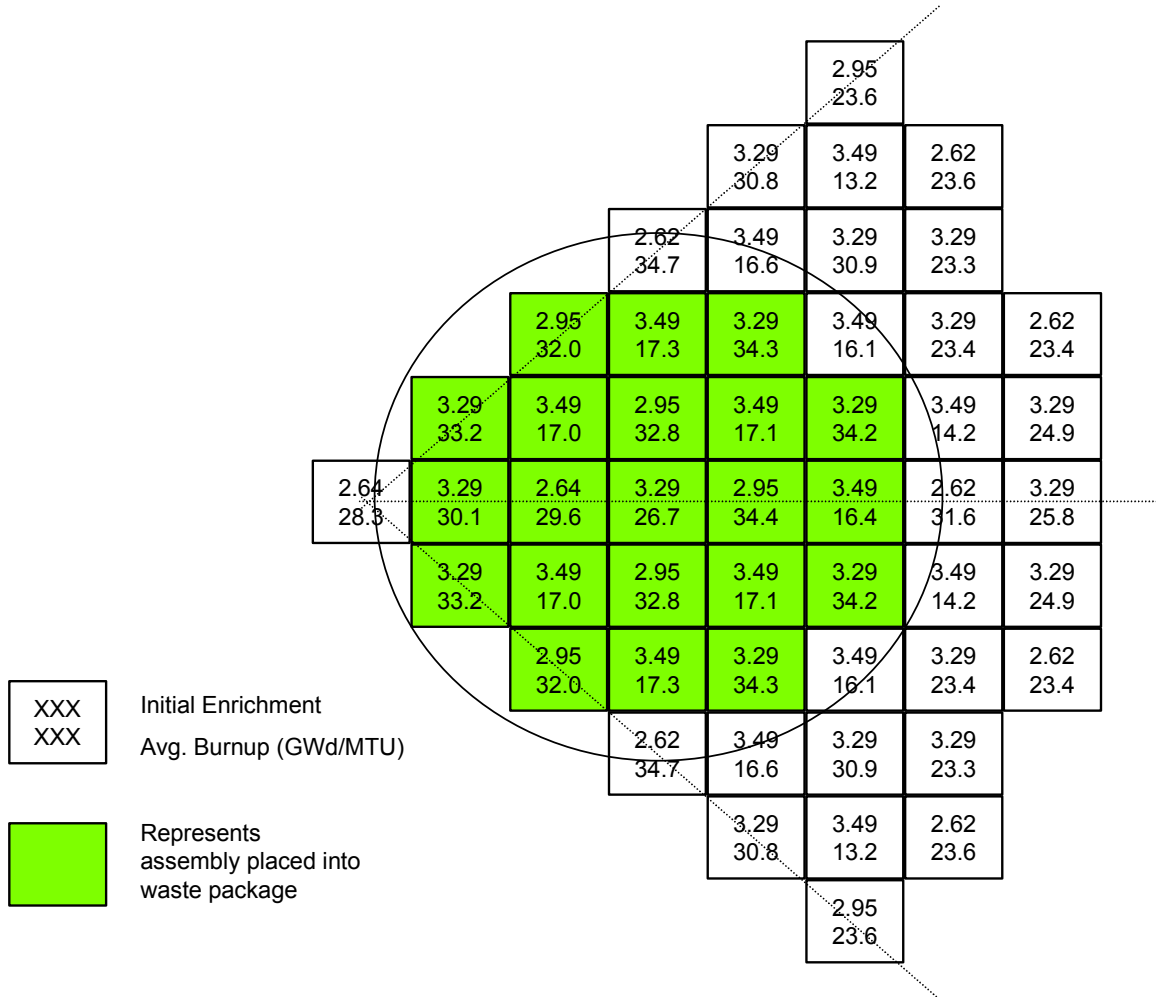

Figure III-19. Radial Profile for CRC and Waste Package Spectral Comparison

A basic understanding of the effect of the spectral variations on reactivity can be achieved by evaluating the fission and absorption reaction rates between the systems. The energy dependent reaction rates are the product of the neutron flux spectrum and the energy dependent total macroscopic cross section. The probability of a fission reaction occurring in the fuel material when a neutron is absorbed in the fuel can be expressed in terms of cross sections. It is the ratio of the fission cross section to that of the total absorption cross section in the fuel material. A plot of reaction rate ratios for a fresh fuel waste package configuration is also provided for comparison against the LCEs in order to exhibit that the fuel material composition is what is governing the reaction rates. With the total macroscopic cross sections for the fuel region in the CRCs and waste package being composed of nearly the same isotopics, the fission probability in the fuel material for these two systems will be very nearly the same as shown in Figure III-20. The magnitude of the fission to absorption ratio for the CRCs and waste package will vary based on burnup, but the shape and area under the curve are expected to remain similar between the two systems.

In the spectral characteristic comparisons, the average flux fraction versus energy was calculated across the system as well as the fission and reaction rates. Although spectral shifts of the type

seen in the LCEs are the result of several effects (e.g., material, H/X ratio, etc.), when compared to the waste package (WP in Figure III-20), the results indicate that CRCs are just as adequate for benchmarks and more closely represents the reaction rates for burned fuel in a waste package configuration.

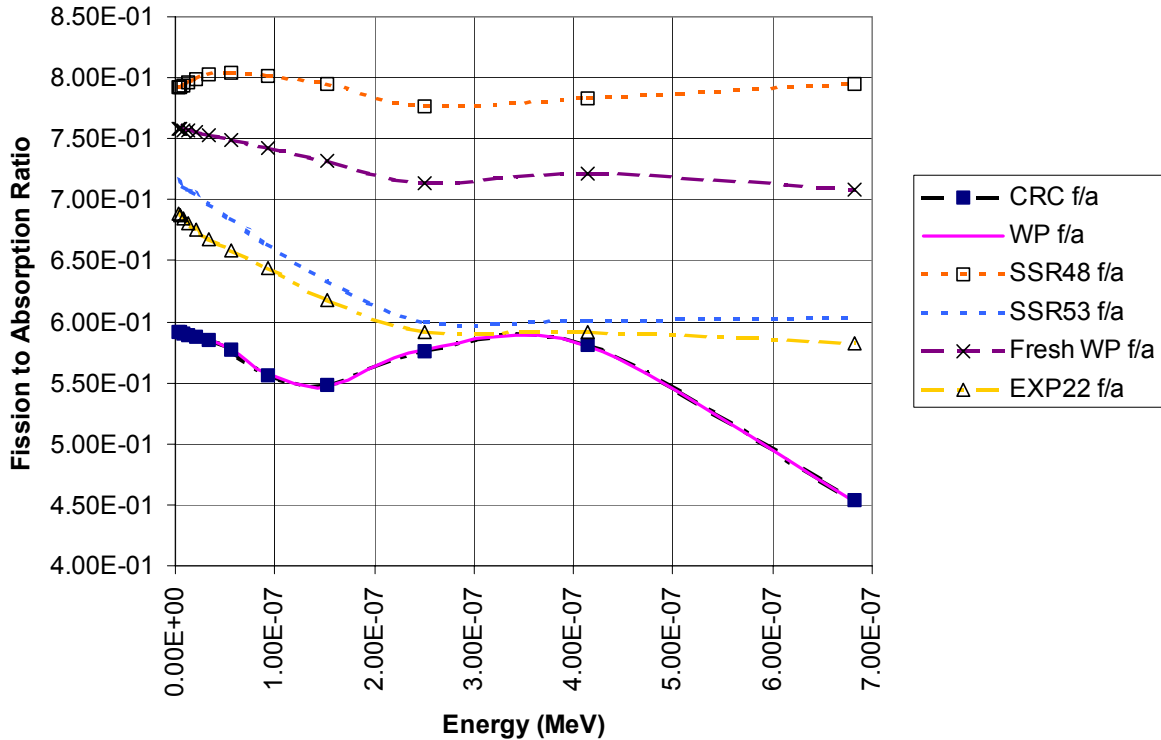

Figure III-20. Thermal Region Reaction Ratio Comparison

The ROA covered by the current set of benchmark experiments are summarized in Table III-33.

Table III-33. Experiment Parameter Summary

Subset	Number of Experiments	Range of Applicability
CRCs	60	Initial enrichment (wt. % ²³⁵ U): 1.93 through 4.17; System average burnup (GWd/MTU): 0.0 through 33; Applicable to intact lattice geometry; Pin pitch (cm): 1.26 through 1.62, AENCF (MeV): 0.235 through 0.265
Lattice LCEs	83	Initial enrichment (wt. % ²³⁵ U): 2.35 through 5.74; mixture of uranium and MOX fuel; Pin Pitch (cm): 1.32 through 2.64 Applicable to intact lattice geometry
UO ₂ Solutions	28	Initial enrichment (wt. % ²³⁵ U): 1.01 through 9.97; H/X: 318 through 1098; Applicable to homogeneous mixtures
Plutonium Solutions	107	Initial enrichment (wt. % ²³⁹ Pu): 91.1 through 99.5; H/X: 91 through 2803; AENCF (eV): 2.46E-03 through 5.96E-02; Applicable to homogeneous mixtures

ATTACHMENT IV

LBTL CALCULATION AND ROA DETERMINATION FOR SHIPPINGPORT LWBR

ATTACHMENT IV

LBTL CALCULATION AND ROA DETERMINATION FOR SHIPPINGPORT LWBR

IV.1 INTRODUCTION

This attachment presents the calculations of LBTL and the determination of ROA for benchmarks that could potentially be applicable to waste package configurations containing Shippingport LWBR SNF. A listing of corroborating and supporting data, models, or information used for the calculation is provided in Table IV-1.

Table IV-1. Supporting Information and Sources

Description	Source
Guidance for benchmarking a calculational method	Dean and Tayloe 2001
Criticality benchmark experiments, trending parameters, and CL calculations	BSC 2002; BSC 2003b, NEA 2001
Shippingport LWBR summary report	CRWMS M&O 2000e

The SNF from the Shippingport LWBR is representative of the thorium-uranium oxide (Th/U oxide) SNF group, which is a mixture of thorium and uranium oxides clad with Zircaloy-4. The natural uranium concentration in the mixture is a maximum of 5.2 wt. %, whereas the ^{233}U content is 5.11 wt. %. This group is one of nine representative fuel groups designated by the National Spent Nuclear Fuel Program for disposal criticality analyses based on the fuel matrix composition, primary fissile isotope and enrichment (DOE 2002, Sections 5.2 and 5.3).

The following information regarding Shippingport LWBR SNF is collected from *Evaluation of Codisposal Viability for Th/U Oxide (Shippingport LWBR) DOE-Owned Fuel* (CRWMS M&O 2000e, Section 2.1.4). The LWBR core was fueled with fertile ^{232}Th and fissile ^{233}U , the relative concentrations of which varied axially and radially across the core to promote high neutron economy. The uranium that was used in fabricating the fuel was mostly (greater than 98 wt. %) ^{233}U , but some isotopic impurities were also present. The design called for vertical fuel rods on a triangular pitch with the space between taken up by circulating cooling water. The fuel rods featured cladding tubes loaded with cylindrical fuel pellets of thoria (ThO_2) or a binary mixture of thoria and UO_2 , and backfilled with helium at 1 atmosphere. The binary fuel is a solid solution fabricated from the two oxides in powder form. Processing of the well-mixed powder preparation achieved a nearly homogeneous structure due to diffusion at elevated temperature during sintering. Axial variations in fissile material concentration was achieved by loading individual fuel rods such that part of the length bore a binary mixture of fissile and fertile material and the rest bore only fertile material. Radial variation was achieved by the arrangement of fuel rods that differed in their axial loading and by using binary pellets of different binary mixtures, depending on the radial location of the rod. Details on the fuel rod characteristics per each fuel zone in the core are available in *Evaluation of Codisposal Viability for Th/U Oxide (Shippingport LWBR) DOE-Owned Fuel* (CRWMS M&O 2000e, p. 13).

The standardized 18-in. diameter DOE SNF canister (15-ft-long) placed with five high-level radioactive waste (HLW) pour canisters in the waste package is used for disposal of Shippingport LWBR fuels, and holds a single Shippingport LWBR SNF seed assembly in a

specially designed basket (CRWMS M&O 2000e, Section 2.1.3). A cross section of the DOE SNF canister containing one Shippingport LWBR assembly and the waste package containing one Shippingport LWBR canister are shown in Figures IV-1 and IV-2, respectively. The basket consists of a 295 mm by 257 mm rectangular grid. The basket plate is stainless steel (Type 316L) with a 9.5-mm thickness. Inside the basket is placed a spacer to limit the length of space available for the Shippingport LWBR seed assembly to 3,350 mm, slightly greater than the maximum length of the intact assemblies, including the shipping plates (3,327.4 mm). The purpose of this limitation is to avoid significant movements of the assembly within the space available during the handling of the DOE SNF canister, with the potential of damaging the assembly and the DOE SNF canister components. The spacer consists of a 293 mm by 255 mm rectangular tube made of 9.5-mm-thick plates that has a 19.1-mm-thick plate attached at the end closer to the assembly location. The spacer plates are made of Stainless Steel Type 316L.

The void inside the DOE SNF canister will be filled with shot consisting of a mixture of Al and GdPO₄. This mixture has the role of a neutron absorber intended to prevent criticality inside the waste package.

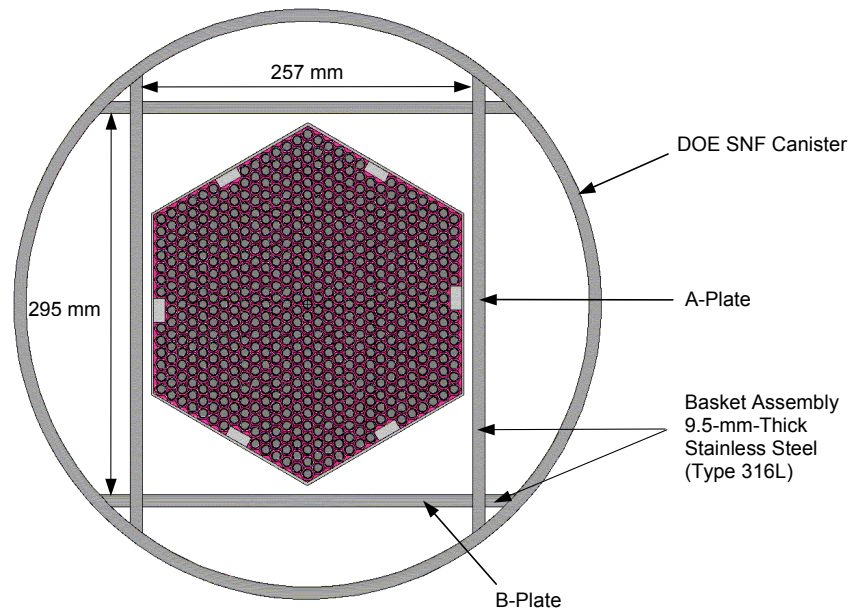

Figure IV-1. Cross Section of the DOE SNF Canister Containing an Assembly of Shippingport LWBR SNF

Figure IV-2 presents a simplified cross section of the waste package containing one DOE SNF canister placed with 5 HLW canisters in a waste package.

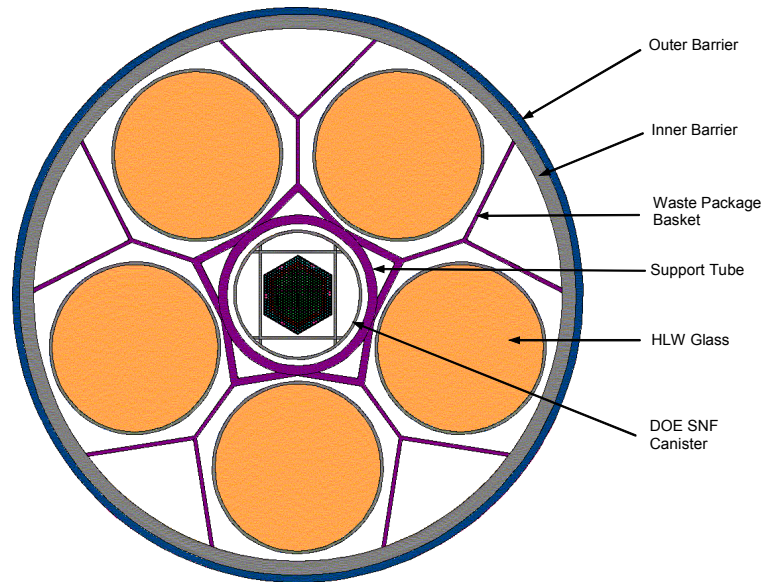

Figure IV-2. Cross Section of the Waste Package Containing Shippingport LWBR SNF

IV.2 SELECTION OF THE CRITICALITY BENCHMARK EXPERIMENTS

The critical experiments selected for inclusion in benchmarking must be representative of the types of materials, conditions, and parameters to be represented using the calculational method. A sufficient number of experiments with varying experimental parameters should be selected for inclusion in the benchmarking to ensure as wide an area of applicability as feasible and statistically significant results. While there is no absolute guideline for the minimum number of critical experiments necessary to benchmark a computational method, the use of only a few (i.e., less than 10) experiments should be accompanied by a suitable technical basis supporting the rationale for acceptability of the results (Dean and Tayloe 2001, p. 5).

For the present application (of Shippingport LWBR SNF), the selected benchmark experiments have been grouped in two subsets (BSC 2002, Section 6.1.7) that include moderated heterogeneous and homogeneous experiments. The benchmark experiments come from *International Handbook of Evaluated Criticality Safety Benchmark Experiments* (NEA 2001), unless otherwise noted. The selection process was initially based on prior knowledge regarding the possible degraded configurations of the waste package (CRWMS M&O 2000e, Section 7), and the subsets have been constructed to accommodate large variations in the range of parameters of the configurations and to provide adequate statistics for LBTL calculations. The selected benchmark experiments for each subset are presented in *Benchmark and Critical Limit Calculation for DOE SNF* (BSC 2002) with MCNP cases constructed and the calculation results. The cases, k_{eff} results, and their uncertainties for all benchmark experiments are also summarized in *Analysis of Critical Benchmark Experiments and Critical Limit Calculation for DOE SNF* (BSC 2003b, Attachment II). Table IV-2 presents the list of the benchmark experiments and the number of cases for each subset selected for Shippingport LWBR SNF.

Table IV-2. Critical Benchmarks Selected for Shippingport LWBR SNF

Subset	Benchmark Experiment Identification ^b	No. of Cases Included
Heterogeneous moderated ^c	Experiment with SB cores ^a	8
	HEU-COMP-MIXED-001	26
	U ²³³ -SOL-THERM-006	12
	HEU-COMP-THERM-003	15
	HEU-COMP-THERM-005	1
	HEU-COMP-THERM-006	3
	HEU-COMP-THERM-007	3
	HEU-COMP-THERM-011	3
	HEU-COMP-THERM-012	2
	HEU-COMP-THERM-013	2
Homogeneous moderated ^c	U ²³³ -SOL-THERM-001	5
	U ²³³ -SOL-THERM-002	17
	U ²³³ -SOL-THERM-003	10
	U ²³³ -SOL-THERM-004	8
	U ²³³ -SOL-THERM-005	2
	U ²³³ -SOL-THERM-006	12
	U ²³³ -SOL-THERM-008	1
	HEU-COMP-MIXED-001	26

Source: Subsets defined and evaluated in BSC 2002 except SB cores experiments that are evaluated in BSC 2003b

NOTES: ^a These experiments were evaluated in BSC 2003b, Section 6.1.

^b The convention for naming the benchmark experiments is from NEA 2001.

^c Identification of each subset from BSC 2002 has been modified to better reflect the subset's main characteristics. The benchmark experiments in each subset have not been affected.

The experiments cover configuration classes IP-1a, IP-1b, IP-2a, IP-3a, IP-3b, IP-3c, and IP-3d for the degraded waste package containing Shippingport LWBR DOE SNF as described in Section 6.6.1.

IV.2.1 Range of Applicability of Selected Critical Benchmark Experiments

This section summarizes in a set of tables (Tables IV-3 to IV-6) the range of applicability of the experiments listed in Table IV-2. The information is partly excerpted from *Benchmark and Critical Limit Calculation for DOE SNF* (BSC 2002, Section 6.2), which presents a less comprehensive set of parameters. The tables have been enhanced by adding information regarding the spectral characteristics of the experiments (available for the majority of the benchmarks in NEA [2001]). The purpose is to construct a collective area of applicability that will be used to directly compare with the range of parameters of the codisposal configurations.

Table IV-3. Range of Applicability of Critical Benchmark Experiments Selected for Comparison with Heterogeneous Moderated Configurations of Shippingport LWBR SNF (Set 1)

Category/ Description	Parameter	Experiment SB-Cores ^a (8 cases)	Experiment HEU-COMP- MIXED-001 (26 cases)	Experiment U ²³³ -SOL- THERM-006 (6 cases)	Experiment HEU-COMP- THERM-003 (15 cases)	Experiment HEU-COMP- THERM-005 (1 case)
Materials/ Fissionable Material	Fissionable Element	Uranium	Uranium	Uranium	Uranium	Uranium
	Physical Form	²³⁵ UO ₂ - ZrO ₂ (3 cases) or ²³³ UO ₂ -ZrO ₂ (5 cases)	UO ₂	Uranyl nitrate	UO ₂ + Cu	UO ₂ + Cu
	Isotopic Composition	92.73 wt. % ²³⁵ U (3 cases) 97.19 wt. % ²³³ U (3 cases) 97.29 wt. % ²³³ U (5 cases)	93.15 wt. % ²³⁵ U	97.56 or 97.54 wt. % ²³³ U	79.66 wt. % ²³⁵ U	79.66 wt. % ²³⁵ U
	Atomic Density (atoms/b-cm)	²³⁵ U: 3.8791e-03 (3 cases) ²³³ U: 2.23e-4 to 3.84e-3 (5 cases)	²³⁵ U: 4.48e-03 to 1.39e-02	²³³ U: 5.14e-04 to 8.64e-04	²³⁵ U: 3.63e-03 ²³⁸ U: 8.72e-04	²³⁵ U: 4.42e-03 ²³⁸ U: 1.06 e-03
	Temperature	Room Temp.	Room Temp.	Room Temp.	Room Temp.	Room Temp.
Materials/ Moderator	Element	H	H	H	H	H
	Physical Form	Water	Water, Alcohol-water solution, Plexiglas	Water in aqueous solution of uranyl nitrate	Water	Water
	Atomic Density (atoms/b-cm)	6.67e-2	Fuel Region: 2.16e-2 (7 cases) 5.68e-2 (Plexiglas) 6.24e-2 (alcohol-water)	5.89e-02 to 6.15e-02	6.67e-02	6.67e-02
	Ratio to Fissile Material (In Region Containing Fissile Material)	37 to 110	0 to 49	69 to 121	51 to 349	23
	Temperature	Room Temp.	Room Temp.	Room Temp.	Room Temp.	Room Temp.
Materials/ Reflector	Material/ Physical Form	Reflected by water	Reflected by polyethylene	Unreflected	Reflected by water and stainless steel	Reflected by water and stainless steel
Materials/ Neutron Absorber	Element	None	None	None	None	None
	Physical Form	N/A	N/A	N/A	N/A	N/A
	Atomic Density (atoms/b-cm)	N/A	N/A	N/A	N/A	N/A

Table IV-3. Range of Applicability of Critical Benchmark Experiments Selected for Comparison with Heterogeneous Moderated Configurations of Shippingport LWBR SNF (Set 1) (Continued)

Category/ Description	Parameter	Experiment SB-Cores ^a (8 cases)	Experiment HEU-COMP- MIXED-001 (26 cases)	Experiment U ²³³ -SOL- THERM-006 (6 cases)	Experiment HEU-COMP- THERM-003 (15 cases)	Experiment HEU-COMP- THERM-005 (1 case)
Geometry	Heterogeneity	Various arrays (triangular- or square-pitched lattices) of fuel rods surrounded by a blanket region and water	Complex arrays of cans in rectangular geometry	Complex arrays of cans containing uranyl nitrate solution in rectangular geometry	Cylindrical two zones hexagonally pitched lattice of cross-shaped fuel rods	Hexagonally pitched array of fuel rod clusters (each containing a hexagonally pitched lattice of cross-shaped fuel rods)
	Shape	Rectangular, hexagonal	Cylinder	Cylinder	Cylinder	Cylinder
Neutron Energy	AENCF	0.057 to 0.095 MeV	0.1045 to 0.8015 MeV	0.0344 to 0.0599 MeV	0.0139 to 0.0467 MeV	0.0764 MeV
	EALF	Not available	Not available	Not available	0.06 to 0.38 eV	1.46 eV
	Neutron Energy Spectra^a	Not available	Not available	Not available	T: 9.9 to 37.7% I: 26.4 to 37% F: 35.9 to 53.1%	T: 6.5% I: 38.4% F: 55.1%
	Fission Rate vs. Neutron Energy^a	Not available	Not available	Not available	T: 75.3 to 94.1% I: 5.2 to 21.9% F: 0.7 to 2.8%	T: 61.3% I: 33.8% F: 4.9%

Source: BSC 2002, NEA 2001, and BSC 2003b, Section 6.1

NOTE: ^aSpectral range defined as follows: thermal (T) [0 to 1 eV], intermediate (I) [1eV to 100 keV], fast (F) [100 keV to 20 MeV].

Table IV-4. Range of Applicability of Critical Benchmark Experiments Selected for Comparison with Heterogeneous Moderated Configurations of Shippingport LWBR SNF (Set 2)

Category/ Description	Parameter	Experiment HEU-COMP- THERM-006 (3 cases)	Experiment HEU-COMP- THERM-007 (3 cases)	Experiment HEU-COMP- THERM-011 (3 cases)	Experiment HEU-COMP- THERM-012 (2 cases)	Experiment HEU-COMP- THERM-013 (2 cases)
Materials/ Fissionable Material	Fissionable Element	Uranium	Uranium	Uranium	Uranium	Uranium
	Physical Form	UO ₂ + Cu	UO ₂ + Cu	UO ₂ + Al alloy	UO ₂ + Al alloy	UO ₂ + Al alloy
	Isotopic Composition	79.66 wt. % ²³⁵ U	79.66 wt. % ²³⁵ U	79.4 wt. % ²³⁵ U	79.4 wt. % ²³⁵ U	79.4 wt. % ²³⁵ U
	Atomic Density (atoms/b-cm)	²³⁵ U: 4.42e-03 ²³⁸ U: 1.06 e-03	²³⁵ U: 3.63e-03 ²³⁸ U: 8.72e-04	²³⁵ U: 2.66e-03 ²³⁸ U: 6.47e-03	²³⁵ U: 2.66e-03 ²³⁸ U: 6.47e-03	²³⁵ U: 2.66e-03 ²³⁸ U: 6.47e-03
	Temperature	Room Temp.	Room Temp.	Room Temp.	Room Temp.	Room Temp.
Materials/ Moderator	Element	Hydrogen	Hydrogen	Hydrogen	Hydrogen	Hydrogen
	Physical Form	Water	Water; ZrH rods	Water	Water	Water
	Atomic Density (atoms/b-cm)	6.67e-02	6.67e-02 (H ₂ O) 5.34e-02 (ZrH)	6.68e-02	6.68e-02	6.68e-02
	Ratio to Fissile Material (In Region Containing Fissile Material)	30 to 716	60 to 91	170	35	40
	Temperature	Room Temp.	Room Temp.	Room Temp.	Room Temp.	Room Temp.
Materials/ Reflector	Material/ Physical Form	Reflected by water and stainless steel	Reflected by water and stainless steel	Reflected by water	Reflected by water	Reflected by water
Materials/ Neutron Absorber	Element	None	None	None	None	None
	Physical Form	N/A	N/A	N/A	N/A	N/A
	Atomic Density (atoms/b-cm)	N/A	N/A	N/A	N/A	N/A
Geometry	Heterogeneity	Cylindrical hexagonally pitched lattice of cross- shaped fuel rods	Cylindrical hexagonally pitched double lattice of cross-shaped fuel rods and ZrH rods	Square clusters of cylindrical fuel rods arranged in square geometry	Square clusters of cylindrical fuel rods arranged in square geometry	Square clusters of cylindrical fuel rods arranged in square geometry
	Shape	Cylinder	Cylinder	Cylinder	Cylinder	Cylinder
Neutron Energy	AENCF	0.0104 to 0.0720 MeV	0.0339 to 0.0475 MeV	0.047 to 0.053 MeV	0.051 to 0.055 MeV	0.043 to 0.048 MeV
	EALF	0.05 to 1.12 eV	0.257 to 0.445 eV	0.43 to 0.72 eV	0.43 to 0.56 eV	0.32 to 0.45 eV
	Neutron Energy Spectra ^a	T: 4.9 to 47% I: 23.2 to 37.7% F: 29.8 to 57.4%	T: 8.0 to 11.9% I: 36.9 to 38.0% F: 51.2 to 54.0%	T: 6.6 to 10.0% I: 37.6 to 40.1% F: 52.4 to 53.5%	T: 7.3 to 9.4% I: 37.1 to 38.4% F: 53.5 to 54.3%	T: 8.6 to 12.1% I: 36 to 37.9% F: 51.9 to 53.5%
	Fission Rate vs. Neutron Energy ^a	T: 64.1 to 96.1% I: 3.4 to 31.5% F: 0.5 to 4.4%	T: 73.8 to 80.9% I: 17.1 to 23.3% F: 2 to 2.9%	T: 68.4 to 74.2% I: 22.8 to 28.2% F: 3.0 to 3.4%	T: 71.8 to 74.7% I: 22.2 to 24.8% F: 3.1 to 3.4%	T: 73.7 to 77.6% I: 19.7 to 23.2% F: 2.7 to 3.1%

Source: BSC 2002 and NEA 2001

NOTE: ^a Spectral range defined as follows: thermal (T) [0 to 1 eV], intermediate (I) [1eV to 100 keV], fast (F) [100 keV to 20 MeV].

Table IV-5. Range of Applicability of Critical Benchmark Experiments Selected for Comparison with Homogeneous Moderated Configurations of Shippingport LWBR SNF (Set 1)

Category/ Description	Parameter	Experiment U ²³³ -SOL- THERM-001 (5 cases)	Experiment U ²³³ -SOL- THERM-002 (17 cases)	Experiment U ²³³ -SOL- THERM-003 (10 cases)	Experiment U ²³³ -SOL- THERM-004 (8 cases)	Experiment U ²³³ -SOL- THERM-005 (2 cases)
Materials/ Fissionable Material	Fissionable Element	Uranium	Uranium	Uranium	Uranium	Uranium
	Physical Form	Uranyl nitrate	Uranyl nitrate	Uranyl fluoride	Uranyl nitrate	Uranyl nitrate
	Isotopic Composition	97.7 wt. % ²³³ U	98.7 wt. % ²³³ U	98.7 wt. % ²³³ U	98.7 wt. % ²³³ U	98.7 wt. % ²³³ U
	Atomic Density (atoms/b-cm)	²³³ U: 4.33e-05 to 5.00e-05	²³³ U: 8.71e-05 to 9.84e-04	²³³ U: 8.56e-05 to 1.55e-03	²³³ U: 4.15e-04 to 9.84e-04	²³³ U: 1.27e-04 and 1.60e-04
	Temperature	Room Temp.	Room Temp.	Room Temp.	Room Temp.	Room Temp.
Materials/ Moderator	Element	H	H	H	H	H
	Physical Form	Solution	Solution	Solution	Solution	Solution
	Atomic Density (atoms/b-cm)	6.63e-02 to 6.64e-02	5.62e-02 to 6.56e-02	6.05e-02 to 6.57e-02	5.62e-02 to 6.22e-02	6.50e-02 and 6.54e-02
	Ratio to Fissile Material	1324 to 1533	57.1 to 752.6	39.4 to 775	57.1 to 149.2	405 and 514
	Temperature	Room Temp.	Room Temp.	Room Temp.	Room Temp.	Room Temp.
Materials/ Reflector	Material/ Physical Form	Unreflected	Reflected by paraffin	Reflected by paraffin	Reflected by paraffin	Reflected by water
Materials/ Neutron Absorber	Element	B	None	None	None	None
	Physical Form	Solution	N/A	N/A	N/A	N/A
	Atomic Density (atoms/b-cm)	B10:2.65e-07 to 1.01e-6	N/A	N/A	N/A	N/A
Geometry	Heterogeneity	Solution contained in an Al sphere	Solution contained in an Al sphere	Solution contained in single Al cylindrical vessel	Solution contained in single Al cylindrical vessel	2 configurations: first has solution contained in a spherical Al vessel,second has solution contained in single Al cylindrical vessel
	Shape	Sphere	Sphere	Cylindrical	Cylindrical	Cylindrical/ Spherical
Neutron Energy	AENCF	0.0038 to 0.0043 MeV	0.0056 to 0.0490 MeV	0.0056 to 0.0693 MeV	0.0208 to 0.0493 MeV	0.0078 to 0.0094 MeV
	EALF	0.0392 to 0.0417 eV	0.0464 to 0.471 eV	0.046 -1.03 eV	0.138 -0.486 eV	Not available
	Neutron Energy Spectra ^a	T: 48.9 to 52.5% I: 21.0 to 22.6% F: 26.5 to 28.5%	T: 7.7 to 42.2% I: 24.8 to 33.9% F: 33.0 to 58.3%	T: 5.2 to 42.6% I: 24.6 to 34.2% F: 32.7 to 60.6%	T: 7.8 to 17.2% I: 32.4 to 34.0% F: 50.4 to 58.3%	Not available
	Fission Rate vs. Neutron Energy ^a	T: 94.0 to 94.8% I: 5.0 to 5.8% F: 0.2%	T: 76.0 to 92.5% I: 7.1 to 33.5% F: 0.3 to 2.8%	T: 54.5 to 92.7% I: 7.0 to 41.5% F: 0.3 to 4.0%	T: 63.8 to 79.5% I: 19.3 to 33.4% F: 1.2 to 2.8%	Not available

Source: BSC 2002 and NEA 2001

NOTE: ^a Spectral range defined as follows: thermal (T) [0 to 1 eV], intermediate (I) [1eV to 100 keV], fast (F) [100 keV to 20 MeV].

Table IV-6. Range of Applicability of Critical Benchmark Experiments Selected for Comparison with Homogeneous Moderated Configurations of Shippingport LWBR SNF (Set 2)

Category/ Description	Parameter	Experiment U ²³³ -SOL- THERM-006 (6 cases)	Experiment U ²³³ -SOL- THERM-008 (1 case)	Experiment HEU-COMP- MIXED-001 (26 cases)
Materials/ Fissionable Material	Fissionable Element	Uranium	Uranium	Uranium
	Physical Form	Uranyl nitrate	Uranyl nitrate	UO ₂
	Isotopic Composition	97.56 or 97.54 wt. % ²³³ U	97.67 wt. % ²³³ U	93.15 wt. % ²³⁵ U
	Atomic Density (atoms/b-cm)	²³³ U: 5.14e-04 to 8.64e-04	²³³ U: 3.34e-05	²³⁵ U: 4.48e-03 to 1.39e-02
	Temperature	Room Temp.	Room Temp.	Room Temp.
Materials/ Moderator	Element	H	H	H
	Physical Form	Water in aqueous solution of uranyl nitrate	Solution	Water, Alcohol-water solution, plexiglas
	Atomic Density (atoms/b-cm)	5.89e-02 to 6.15e-02	6.64e-02	Fuel Region: 2.16e-2 (few cases) 5.68e-2 (Plexiglas) 6.24e-2 (alcohol-water)
	Ratio to Fissile Material	H/X=69 to 121	1324 to 1533	H/X=0 to 49
	Temperature	Room Temp.	Room Temp.	Room Temp.
Materials/ Reflector	Material/Physical Form	Unreflected	Unreflected	Reflected by polyethylene
Materials/ Neutron Absorber	Element	None	None	None
	Physical Form	N/A	N/A	N/A
	Atomic Density (atoms/b-cm)	N/A	N/A	N/A
Geometry	Heterogeneity	Complex arrays of cans containing uranyl nitrate solution in rectangular geometry	Solution contained in an Al sphere	Complex arrays of cans in rectangular geometry
	Shape	Parallel-piped	Sphere	Cylinder
Neutron Energy	AENCF	0.0344 to 0.0599 MeV	0.0030 MeV	0.1045 to 0.8015 MeV
	EALF	Not available	0.037 eV	Not available
	Neutron Energy Spectra ^a	Not available	T: 57.0% I: 19.3% F: 23.7%	Not available
	Fission Rate vs. Neutron Energy ^a	Not available	T: 95.5% I: 4.3% F: 0.2%	Not available

Source: BSC 2002 and NEA 2001

NOTE: ^aSpectral range defined as follows: thermal (T) [0 to 1 eV], intermediate (I) [1eV to 100 keV], fast (F) [100 keV to 20 MeV].

IV.3 Calculation of the Lower-Bound Tolerance Limit

The following results are excerpted from *Analysis of Critical Benchmark Experiments and Critical Limit Calculation for DOE SNF* (BSC 2003b), which present in detail the methodology and calculations performed for evaluating the LBTL for each set of configurations of the waste package containing Shippingport LWBR SNF. The calculated k_{eff} values for the critical benchmarks are taken from *Analysis of Critical Benchmark Experiments and Critical Limit Calculation for DOE SNF* (BSC 2003b, Attachment II). The results of the trending parameter analysis for the critical benchmark subset representative for moderated intact (heterogeneous) configurations of the waste package containing Shippingport LWBR SNF are presented in Table IV-7. The parameters in the following tables describe the regression statistics for the linear trend evaluations (see Attachment III for definitions). The P-value parameter gives a direct estimation of the probability of having a linear trending due to chance only.

Table IV-7. Trending Parameter Results for the Critical Benchmark Subset Representative for Moderated Intact Fuel (Heterogeneous) Configurations of the Waste Package Containing Shippingport LWBR SNF

Trend Parameter	n	Intercept	Slope	r^2	T	$t_{0.025,n-2}$	P-Value	Goodness-of-Fit Tests	Valid Trend
AENCF	75	0.9998	-4.87E-03	0.0237	-1.3309	1.960	0.1874	Failed	No
H/X	64	0.9984	1.07E-05	0.0185	1.0821	1.960	0.2834	Failed	No

Source: BSC 2003b, p. 53

Figure IV-3 presents the k_{eff} values and the calculated lower-bound tolerance limit. The LBTL value calculated with the distribution-free tolerance limit (DFTL) method for this subset (normality test failed) is calculated in *Analysis of Critical Benchmark Experiments and Critical Limit Calculation for DOE SNF* (BSC 2003b, Attachment I) as 0.9751.

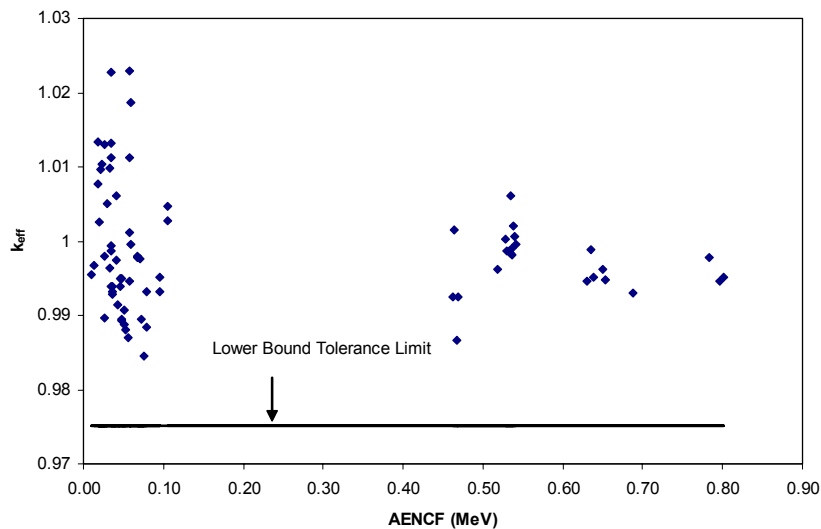

Figure IV-3. Lower-Bound Tolerance Limit Applicable for Shippingport LWBR SNF for Intact (Heterogeneous) Moderated Configurations

The results of the trending parameter analysis for the critical benchmark subset representative for moderated degraded configurations of the waste package containing Shippingport LWBR SNF are presented in Table IV-8.

Table IV-8. Trending Parameter Results for the Critical Benchmark Subset Representative for Moderated Degraded Configurations of the Waste Package Containing Shippingport LWBR SNF

Trend Parameter	n	Intercept	Slope	r ²	T	t _{0.025,n-2}	P-Value	Goodness-of-Fit Tests	Valid Trend
AENCF	81	1.0042	-0.0115	0.1205	-3.2902	1.960	1.497E-03	Failed	No
H/X	78	1.0024	-1.02E-06	2.304E-03	-0.4189	1.960	0.6765	Failed	No

Source: BSC 2003b, p. 55

Figure IV-4 presents the k_{eff} values and the calculated LBTL. The LBTL value calculated with the DFTL method for this subset (normality test failed) is 0.9748 (BSC 2003b, Attachment I).

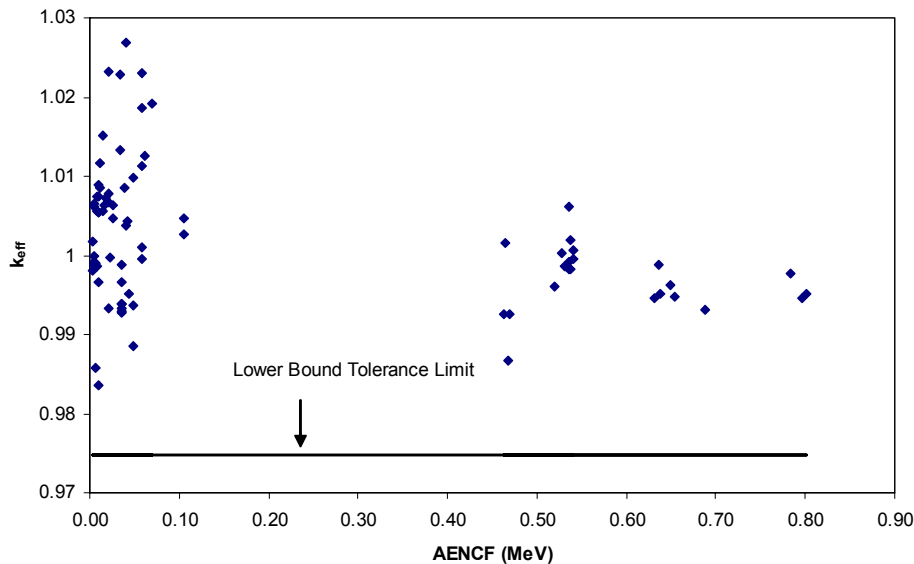

Figure IV-4. Lower-Bound Tolerance Limit Applicable for Shippingport LWBR SNF for Degraded (Homogeneous) Moderated Configurations

Table IV-9 presents a summary of the results of the analyses performed on the subsets of critical benchmark experiments applicable to the waste package containing Shippingport LWBR SNF and the calculated LBTL values.

Table IV-9. Lower-Bound Tolerance Limits for Benchmark Subsets Representative for the Configurations of the I Waste Packages Containing Shippingport LWBR SNF

Subset	Trend Parameter	Test for Normality	Applied Computational Method	Lower-Bound Tolerance Limit or Lower-Bound Tolerance Limit Function
Intact (heterogeneous) Moderated	None	Failed	DFTL	Lower-bound tolerance limit = 0.9751
Degraded (homogeneous) Moderated	None	Failed	DFTL	Lower-bound tolerance limit = 0.9748

Source: BSC 2003b, p. 57

INTENTIONALLY LEFT BLANK

ATTACHMENT V
LBTL CALCULATION AND ROA DETERMINATION FOR ENRICO FERMI

ATTACHMENT V

LBTL CALCULATION AND ROA DETERMINATION FOR ENRICO FERMI

V.1 INTRODUCTION

This attachment presents the calculations of LBTL and the determination of ROA for benchmarks that could potentially be applicable to waste package configurations containing Enrico Fermi SNF. A listing of corroborating and supporting data, models, or information used for the calculation is provided in Table V-1.

Table V-1. Supporting Information and Sources

Description	Source
Guidance for benchmarking a calculational method	Dean and Tayloe 2001
Criticality benchmark experiments, trending parameters, and CL calculations	BSC 2002; BSC 2003b; NEA 2001
Enrico Fermi summary report	CRWMS M&O 2000c

The Enrico Fermi uranium-molybdenum (U-Mo) alloy SNF is representative of the U-Zr and U-Mo highly enriched uranium (HEU) SNF group. This group is one of nine representative fuel groups designated by the National Spent Nuclear Fuel Program for disposal criticality analyses based on the fuel matrix composition, primary fissile isotope and enrichment (DOE 2002, Sections 5.2 and 5.3).

The following information regarding Enrico Fermi SNF is collected from *Evaluation of Codisposal Viability for U-Zr/U-Mo Alloy (Enrico Fermi) DOE-Owned Fuel* (CRWMS M&O 2000c, Section 2.1.4) except where indicated otherwise. The Enrico Fermi SNF pin is made of a solid uranium-molybdenum alloy, 3.7592 mm (0.148 in.) in diameter, and is bonded metallurgically to a zirconium cladding with an outer diameter of 4.0132 mm (0.158 in.). There is no gap between the fuel and the clad. The U-Mo fuel alloy contains 84.6 wt. % U with an enrichment of 25.69 wt. % ²³⁵U. The length of the SNF pins is 774.70 mm (30.5 in.) and the ends of the pins have been cold swaged to a point to provide mechanical seal for the U-Mo alloy.

Currently, all the Enrico Fermi fuel assemblies are disassembled (derodded), and the fuel pins are stored under water in aluminum canisters. Fuel sections of 140 pins are stored loose-packed without any supporting/spacing mechanism in aluminum canisters (referred to as “-04” canisters) that were placed inside aluminum shipping canisters (referred to as “-01” canisters) (CRWMS M&O 2000c, Section 2.1.3).

The current conceptual design for disposing Enrico Fermi SNF in the repository is the use of the standardized 18-in. diameter DOE SNF codisposal canister (CRWMS M&O 2000c, Section 2.1.3) placed with five HLW pour canisters in the waste package. The DOE SNF canister is placed in a carbon-steel support basket that holds the canister in the center of the waste package. The five HLW canisters are evenly spaced around the support that holds the DOE SNF canister.

The disposal configuration for the Enrico Fermi SNF comprises a stack of two baskets containing SNF placed inside a DOE SNF canister. Twelve 4-in. diameter stainless steel pipes

(316L) are welded to a base plate to form a basket. An aluminum shipping canister (“-01” canister) containing the “-04” canister with 140 fuel pins is placed in each fuel pipe. The space between all the 4-in.-diameter pipes in each basket and between each “-01” canister and the stainless steel pipe is filled with a mixture of iron shot (moderator displacer) and gadolinium phosphate (neutron absorber). The iron shot contains 3 percent by volume gadolinium phosphate ($GdPO_4$), i.e., 14.5 kg of gadolinium phosphate per 737.9 kg of iron (CRWMS M&O 2000c, pp. vii and viii).

Figure V-1 presents a cross section of the DOE SNF canister containing Enrico Fermi SNF placed in a waste package. The rest of the waste package is not represented in order to show the constituents inside the DOE SNF canister.

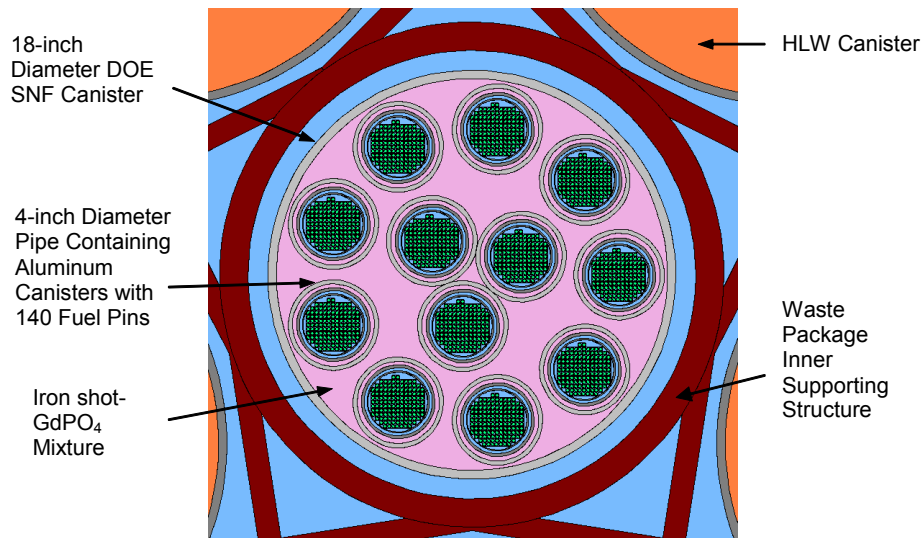

Figure V-1. Cross Section of the DOE SNF Canister Containing Enrico Fermi SNF Placed Inside Waste Package

V.2 SELECTION OF THE CRITICALITY BENCHMARK EXPERIMENTS

The critical experiments selected for inclusion in benchmarking must be representative of the types of materials, conditions, and parameters to be represented using the calculational method. A sufficient number of experiments with varying experimental parameters should be selected for inclusion in the benchmarking to ensure as wide an area of applicability as feasible and statistically significant results. While there is no absolute guideline for the minimum number of critical experiments necessary to benchmark a computational method, the use of only a few (i.e., less than 10) experiments should be accompanied by a suitable technical basis supporting the rationale for acceptability of the results (Dean and Tayloe 2001, p. 5).

For the present application (codisposal of Enrico Fermi SNF), the selected benchmark experiments have been grouped in four subsets (BSC 2002, Section 6.1.4), that include heterogeneous and homogeneous experiments, each divided into subsets of moderated (thermal spectrum) and nonmoderated experiments (fast spectrum). The benchmark experiments come from *International Handbook of Evaluated Criticality Safety Benchmark Experiments*

(NEA 2001), unless otherwise noted. The selection process was initially based on prior knowledge regarding the possible degraded configurations of the waste package (CRWMS M&O 2000c, Section 7), and the subsets have been constructed to accommodate large variations in the range of parameters of the configurations and to provide adequate statistics for LBTL calculations. The selected benchmark experiments for each subset are presented in *Benchmark and Critical Limit Calculation for DOE SNF* (BSC 2002) with MCNP cases constructed and calculation results. The cases, k_{eff} results, and their uncertainties are also summarized in *Analysis of Critical Benchmark Experiments and Critical Limit Calculation for DOE SNF* (BSC 2003b, Attachment II). Table V-2 presents the list of the benchmark experiments and the number of cases for each subset selected for Enrico Fermi SNF.

The experiments cover configuration classes IP-1a, IP-2a, IP-3a, IP-3b, IP-3c, and IP-3d for the degraded waste package containing Enrico Fermi SNF as described in Section 7.

Table V-2. Critical Benchmarks Selected for Enrico Fermi SNF

Subset	Benchmark Experiment Identification ^a	No. of Cases Included
Heterogeneous Moderated ^b	IEU-COMP-THERM-002	6
	IEU-COMP-THERM-003	2
	HEU-COMP-THERM-003	15
	HEU-COMP-THERM-004	4
	HEU-COMP-THERM-005	1
	HEU-COMP-THERM-006	3
	HEU-COMP-THERM-007	3
	IEU-COMP-THERM-001	29
Heterogeneous Nonmoderated ^b	IEU-MET-FAST-001	4
	IEU-MET-FAST-002	1
	IEU-MET-FAST-003	1
	IEU-MET-FAST-004	1
	IEU-MET-FAST-005	1
	IEU-MET-FAST-006	1
	IEU-MET-FAST-007	1
	IEU-MET-FAST-008	1
	IEU-MET-FAST-009	1
	IEU-MET-FAST-010	1
Homogeneous Moderated ^b	IEU-SOL-THERM-001	4
	IEU-COMP-THERM-001	29
	LEU-SOL-THERM-003	9
	LEU-SOL-THERM-004	7
	LEU-SOL-THERM-006	5
	LEU-SOL-THERM-007	5
	LEU-SOL-THERM-008	4
	LEU-SOL-THERM-009	3
	LEU-SOL-THERM-010	4
	LEU-SOL-THERM-016	7
	LEU-SOL-THERM-017	6
	LEU-SOL-THERM-018	6
	LEU-SOL-THERM-019	6
	LEU-SOL-THERM-020	4
LEU-SOL-THERM-021	4	

Source: Subsets defined in BSC 2002

NOTES: ^aThe convention for naming the benchmark experiments is from NEA 2001.

^bIdentification of each subset from BSC 2002 has been modified to better reflect the subset's main characteristics. The benchmark experiments in each subset have not been affected.

V.2.1 RANGE OF APPLICABILITY OF SELECTED CRITICAL BENCHMARK EXPERIMENTS

This section summarizes in a set of tables (Tables V-3 to V-9) the range of applicability of the experiments listed in Table V-2. The information is partly excerpted from *Benchmark and Critical Limit Calculation for DOE SNF* (BSC 2002, Section 6.2) which presents a less comprehensive set of parameters. The tables have been enhanced by adding information regarding the spectral characteristics of the experiments (where available in *International Handbook of Evaluated Criticality Safety Benchmark Experiments* [NEA 2001]) to construct a collective area of applicability that will be used to directly compare with the range of parameters of the codisposal configurations.

Table V-3. Range of Applicability of Critical Benchmark Experiments Selected for Comparison with Heterogeneous Moderated Configurations of Enrico Fermi SNF (Set 1)

Category/Description	Parameter	Experiment IEU-COMP-THERM-001 (29 cases)	Experiment IEU-COMP-THERM-002 (6 cases)	Experiment IEU-COMP-THERM-003 (2 cases)	Experiment HEU-COMP-THERM-003 (15 cases)
Materials/ Fissionable Material	Fissionable Element	Uranium	Uranium	Uranium	Uranium
	Physical Form	UF4 compound with polytetrafluoroethylene	UO ₂	U-ZrH	UO ₂ + Cu
	Isotopic Composition	29.83 wt. % ²³⁵ U	17 wt. % ²³⁵ U	19.9 wt. % ²³⁵ U	79.66 wt. % ²³⁵ U
	Atomic Density (atoms/b-cm)	²³⁵ U: 2.37e-03 ²³⁸ U: 5.50e-03	²³⁵ U: 1.89e-03 ²³⁸ U: 9.06e-03	²³⁵ U: 3.68e-04 ²³⁸ U: 1.46e-03	²³⁵ U: 3.63e-03 ²³⁸ U: 8.72e-04
	Temperature	Room Temp.	288 K to 492 K	Room Temp.	Room Temp.
Materials/ Moderator	Element	H; C	H	H	H
	Physical Form	Polyethylene	Water	ZrH; Water	Water
	Atomic Density (atoms/b-cm)	H:7.5224e-02 C:3.9232e-02	5.64e-02 to 6.67e-02	5.63e-02 (in ZrH) 6.67e-02 (H ₂ O)	6.67e-02
	Ratio to Fissile Material (In Region Containing Fissile Material)	Range: H/ ²³⁵ U = 4 to 222	Not available	150.1	51 to 349
	Temperature	Room Temp.	288 K to 492 K	Room Temp.	Room Temp.
Materials/ Reflector	Material/ Physical Form	Unreflected or reflected by paraffin, Cd	Reflected by water	Reflected radially by graphite and axially by water	Reflected by water and stainless steel
Materials/ Neutron Absorber	Element	B or Cd for some experiments	Gd, Cd for some experiments	B	None
	Physical Form	Metallic sheets	Gd ₂ O ₃ or CdO placed in rods	B ₄ C absorber rods	Not needed for ROA and ROP comparison

Table V-3. Range of Applicability of Critical Benchmark Experiments Selected for Comparison with Heterogeneous Moderated Configurations of Enrico Fermi SNF (Set 1) (Continued)

Category/ Description	Parameter	Experiment IEU-COMP- THERM-001 (29 cases)	Experiment IEU-COMP- THERM-002 (6 cases)	Experiment IEU-COMP- THERM-003 (2 cases)	Experiment HEU-COMP- THERM-003 (15 cases)
	Atomic Density (atoms/b-cm)	N/A	Gd-2.16e-3	Not needed for ROA and ROP comparison	Not needed for ROA and ROP comparison
Geometry	Heterogeneity	Heterogeneous small cubes of fissile compound interspersed with moderator cubes	Cylindrical hexagonally pitched lattice of pins (pitch=6.8 cm)	Complex cylindrical arrays of pins	Cylindrical two zones hexagonally pitched lattice of cross-shaped fuel rods
	Shape	Cuboid	Cylinder	Cylinder	Cylinder
Neutron Energy	AENCF	0.0455 to 0.2168 MeV	0.0440 to 0.0490 MeV	0.0240 MeV	0.0139 to 0.0467 MeV
	EALF	0.11 to 9.09 eV	Not available	Not available	0.06 to 0.38 eV
	Neutron Energy Spectra^a	T: 1.8 to 22.8% I: 24.9 to 40.2% F: 49.6 to 63%	Not available	Not available	T: 9.9 to 37.7% I: 27.4 to 37% F: 35.9 to 53.1%
	Fission Rate vs. Neutron Energy^a	T: 47.5 to 90.9% I: 7.1 to 42.8% F: 2.0 to 11.1%	Not available	Not available	T: 75.3 to 94.1% I: 5.2 to 21.9% F: 0.7 to 2.8%

Source: BSC 2002 and NEA 2001, Spectra

NOTE: ^aSpectral range defined as follows: thermal (T) [0 to 1 eV], intermediate (I) [1eV to 100 keV], fast (F) [100 keV to 20 MeV].

Table V-4. Range of Applicability of Critical Benchmark Experiments Selected for Comparison with Heterogeneous Moderated Configurations of Enrico Fermi SNF (Set 2)

Category/Description	Parameter	Experiment HEU-COMP-THERM-004 (4 cases)	Experiment HEU-COMP-THERM-005 (1 case)	Experiment HEU-COMP-THERM-006 (3 cases)	Experiment HEU-COMP-THERM-007 (3 cases)
Materials/ Fissionable Material	Fissionable Element	Uranium	Uranium	Uranium	Uranium
	Physical Form	UO ₂ + Cu	UO ₂ + Cu	UO ₂ + Cu	UO ₂ + Cu
	Isotopic Composition	88.87 wt. % ²³⁵ U	79.66 wt. % ²³⁵ U	79.66 wt. % ²³⁵ U	79.66 wt. % ²³⁵ U
	Atomic Density (atoms/b-cm)	²³⁵ U: 5.13e-03 ²³⁸ U: 5.77e-04	²³⁵ U: 4.42e-03 ²³⁸ U: 1.06 e-03	²³⁵ U: 4.42e-03 ²³⁸ U: 1.06 e-03	²³⁵ U: 3.63e-03 ²³⁸ U: 8.72e-04
	Temperature	Room Temp.	Room Temp.	Room Temp.	Room Temp.
Materials/ Moderator	Element	Hydrogen	Hydrogen	Hydrogen	Hydrogen
	Physical Form	Water	Water	Water	Water; ZrH rods
	Atomic Density (atoms/b-cm)	6.67e-02	6.67e-02	6.67e-02	6.67e-02 (H ₂ O) 5.34e-02 (ZrH)
	Ratio to Fissile Material (In Region Containing Fissile Material)	35	23	30 to 716	60 to 91
	Temperature	Room Temp.	Room Temp.	Room Temp.	Room Temp.
Materials/ Reflector	Material/ Physical Form	Reflected by water and stainless steel	Reflected by water and stainless steel	Reflected by water and stainless steel	Reflected by water and stainless steel
Materials/ Neutron Absorber	Element	Gd; Sm	None	None	None
	Physical Form	Gd ₂ O ₃ or Sm ₂ O ₃ Rods	N/A	N/A	N/A
	Atomic Density (atoms/b-cm)	Gd: 3.11e-04	N/A	N/A	N/A
Geometry	Heterogeneity	Cylindrical hexagonally pitched double lattice of cross-shaped fuel rods and absorber rods	Hexagonally pitched array of fuel rod clusters (each containing a hexagonally pitched lattice of cross-shaped fuel rods)	Cylindrical hexagonally pitched lattice of cross-shaped fuel rods	Cylindrical hexagonally pitched double lattice of cross-shaped fuel rods and ZrH rods
	Shape	Cylinder	Cylinder	Cylinder	Cylinder
Neutron Energy	AENCF	0.0736 to 0.0756 MeV	0.0764 MeV	0.0104 to 0.0720 MeV	0.0339 to 0.0475 MeV
	EALF	1.35 to 1.52 eV	1.46 eV	0.05 to 1.12 eV	0.257 to 0.445 eV
	Neutron Energy Spectra ^a	T: 3.6 to 4.1% I: 38.2 to 38.5% F: 57.6 to 58.1%	T: 6.5% I: 38.4% F: 55.1%	T: 4.9 to 47% I: 23.2 to 37.7% F: 29.8 to 57.4%	T: 8.0 to 11.9% I: 36.9 to 38.0% F: 51.2 to 54.0%
	Fission Rate vs. Neutron Energy ^a	T: 60.6 to 62.6% I: 32.9 to 34.7% F: 4.5 to 4.7%	T: 61.3% I: 33.8% F: 4.9%	T: 64.1 to 96.1% I: 3.4 to 31.5% F: 0.5 to 4.4%	T: 73.8 to 80.9% I: 17.1 to 23.3% F: 2 to 2.9%

Source: BSC 2002 and NEA 2001, Spectra

NOTE: ^aSpectral range defined as follows: thermal (T) [0 to 1 eV], intermediate (I) [1eV to 100 keV], fast (F) [100 keV to 20 MeV].

Table V-5. Range of Applicability of Critical Benchmark Experiments Selected for Comparison with Heterogeneous Nonmoderated Configurations of Enrico Fermi SNF (Set 3)

Category/ Description	Parameter	Experiment IEU-MET- FAST-001 (4 cases)	Experiment IEU-MET- FAST-002 (1 case)	Experiment IEU-MET- FAST-003 (1 case)	Experiment IEU-MET- FAST-004 (1 case)	Experiment IEU-MET- FAST-005 (1 case)
Materials/ Fissionable Material	Fissionable Element	Uranium	Uranium	Uranium	Uranium	Uranium
	Physical Form	Metal discs (highly enriched interspersed with natural U	Metal discs (highly enriched interspersed with natural U	U metal	U metal	U metal
	Isotopic Composition	93.4 wt. % ²³⁵ U (for highly enriched discs[HEU])	16.19 wt. % ²³⁵ U (average)	36.5 wt. % ²³⁵ U (average)	36.5 wt. % ²³⁵ U (average)	36.5 wt. % ²³⁵ U (average)
	Atomic Density (atoms/b-cm)	For HEU discs ²³⁵ U: 4.50e-02 ²³⁸ U: 2.65e-03	²³⁵ U: 7.78e-03 ²³⁸ U: 3.97e-01	²³⁵ U: 1.71e-02 ²³⁸ U: 2.92e-02	²³⁵ U: 1.74e-02 ²³⁸ U: 2.97e-02	²³⁵ U: 1.72e-02 ²³⁸ U: 2.93e-03
	Temperature	Room Temp.	Room Temp.	Room Temp.	Room Temp.	Room Temp.
Materials/ Moderator	Element	None	None	None	None	None
	Physical Form	N/A	N/A	N/A	N/A	N/A
	Atomic Density (atoms/b-cm)	N/A	N/A	N/A	N/A	N/A
	Ratio to Fissile material	N/A	N/A	N/A	N/A	N/A
	Temperature	N/A	N/A	N/A	N/A	N/A
Materials/ Reflector	Material/ Physical Form	Unreflected	Reflected by natural U	Unreflected	Reflected by graphite	Reflected by steel
Materials/ Neutron Absorber	Element	None	None	None	None	None
	Physical Form	N/A	N/A	N/A	N/A	N/A
	Atomic Density (atoms/b-cm)	N/A	N/A	N/A	N/A	N/A
Geometry	Heterogeneity	Complex cylindrical geometry comprising interspersed U discs (highly enriched and natural U)	Complex cylindrical geometry comprising interspersed U discs (highly enriched and natural U)	Spherical core with multiple layers	Spherical core with multiple layers	Spherical core with multiple layers
	Shape	Cylinder	Cylinder	Sphere	Sphere	Sphere

Table V-5. Range of Applicability of Critical Benchmark Experiments Selected for Comparison with Heterogeneous Nonmoderated Configurations of Enrico Fermi SNF (Set 3) (Continued)

Category/ Description	Parameter	Experiment IEU-MET- FAST-001 (4 cases)	Experiment IEU-MET- FAST-002 (1 case)	Experiment IEU-MET- FAST-003 (1 case)	Experiment IEU-MET- FAST-004 (1 case)	Experiment IEU-MET- FAST-005 (1 case)
Neutron Energy	AENCF	1.3859 to 1.4398 MeV	1.2784 MeV	1.3502 MeV	1.3071 MeV	1.2852 MeV
	EALF	from 7.18e5 to 7.74 e5 eV	5.64e05 eV	6.87e05 eV	6.46e05 eV	6.47e05 eV
	Neutron Energy Spectra ^a	T: 0% I: 5.4 to 6.8% F: 93.2 to 94.6%	T: 0% I: 14% F: 86	T: 0% I: 7.2% F: 92.8	T: 0% I: 8.2% F: 91.8%	T: 0% I: 7.8% F: 92.2%
	Fission Rate vs. Neutron Energy ^a	T: 0% I: 7 to 8.3% F: 91.7 to 93%	T: 0% I: 15.4% F: 84.6%	T: 0% I: 8.8% F: 91.2%	T: 0% I: 10.1% F: 89.9%	T: 0% I: 9.6% F: 90.4%

Source: BSC 2002 and NEA 2001, Spectra

NOTE: ^aSpectral range defined as follows: thermal (T) [0 to 1 eV], intermediate (I) [1eV to 100 keV], fast (F) [100 keV to 20 MeV].

Table V-6. Range of Applicability of Critical Benchmark Experiments Selected for Comparison with Heterogeneous Nonmoderated Configurations of Enrico Fermi SNF (Set 4)

Category/ Description	Parameter	Experiment IEU-MET- FAST-006 (1 case)	Experiment IEU-MET- FAST-007 (1 case)	Experiment IEU-MET- FAST-008 (1 case)	Experiment IEU-MET- FAST-009 (1 case)	Experiment IEU-MET- FAST-010 (1 case)
Materials/ Fissionable Material	Fissionable Element	Uranium	Uranium	Uranium	Uranium	Uranium
	Physical Form	U metal	U metal	U metal	U metal	U metal
	Isotopic Composition	36.5 wt. % ²³⁵ U (average)	10 wt. % ²³⁵ U (average)	36.5 wt. % ²³⁵ U (average)	36.5 wt. % ²³⁵ U (average)	9 wt. % ²³⁵ U (average)
	Atomic Density (atoms/b-cm)	²³⁵ U: 1.72e-02 ²³⁸ U: 2.93e-02	²³⁵ U: 4.82e-03 ²³⁸ U: 4.32e-02	²³⁵ U: 1.72e-02 ²³⁸ U: 2.95e-02	²³⁵ U: 1.74e-02 ²³⁸ U: 2.99e-02	²³⁵ U: 3.48e-03 ²³⁸ U: 3.52e-02
	Temperature	Room Temp.	Room Temp.	Room Temp.	Room Temp.	Room Temp.
Materials/ Moderator	Element	None	None	None	None	None
	Physical Form	N/A	N/A	N/A	N/A	N/A
	Atomic Density (atoms/b-cm)	N/A	N/A	N/A	N/A	N/A
	Ratio to Fissile Material	N/A	N/A	N/A	N/A	N/A
	Temperature	N/A	N/A	N/A	N/A	N/A

Table V-6. Range of Applicability of Critical Benchmark Experiments Selected for Comparison with Heterogeneous Nonmoderated Configurations of Enrico Fermi SNF (Set 4) (Continued)

Category/ Description	Parameter	Experiment IEU-MET- FAST-006 (1 case)	Experiment IEU-MET- FAST-007 (1 case)	Experiment IEU-MET- FAST-008 (1 case)	Experiment IEU-MET- FAST-009 (1 case)	Experiment IEU-MET- FAST-010 (1 case)
Materials/ Reflector	Material/ Physical Form	Reflected by duralumin	Reflected by depleted U	Reflected by depleted U	Reflected by polyethylene	Reflected by depleted U
Materials/ Neutron Absorber	Element	None	None	None	None	None
	Physical Form	N/A	N/A	N/A	N/A	N/A
	Atomic Density (atoms/b-cm)	N/A	N/A	N/A	N/A	N/A
Geometry	Heterogeneity	Spherical core with multiple layers	Complex cylindrical geometry	Spherical core with multiple layers	Spherical core with multiple layers	Spherical core with multiple layers
	Shape	Sphere	Cylinder	Sphere	Sphere	Sphere
Neutron Energy	AENCF	1.2892 MeV	1.2530 MeV	1.3650 MeV	1.0140 MeV	1.1490 MeV
	EALF	6.39e05 eV	4.97e05 eV	6.85e05 eV	1.68e04 eV	4.25e05 eV
	Neutron Energy Spectra ^a	T: 0% I: 8% F: 92%	T: 0% I: 19.0% F: 81%	T: 0% I: 7.9% F: 92.1%	T: 0.1% I: 9.6% F: 90.3%	T: 0% I: 22% F: 78%
	Fission Rate vs. Neutron Energy ^a	T: 0% I: 9.8% F: 90.2%	T: 0% I: 19.6% F: 80.4%	T: 0% I: 9.8% F: 90.2%	T: 17.5% I: 19.3% F: 63.2%	T: 0% I: 22.7% F: 77.3%

Source: BSC 2002 and NEA 2001, Spectra

NOTE: ^aSpectral range defined as follows: thermal (T) [0 to 1 eV], intermediate (I) [1eV to 100 keV], fast (F) [100 keV to 20 MeV].

Table V-7. Range of Applicability of Critical Benchmark Experiments Selected for Comparison with Homogeneous Moderated Configurations of Enrico Fermi SNF (Set 1)

Category/ Description	Parameter	Experiment IEU-SOL- THERM-001 (4 cases)	Experiment IEU-COMP- THERM-001 (29 cases)	Experiment LEU-SOL- THERM-003 (9 cases)	Experiment LEU-SOL- THERM-004 (7 cases)	Experiment LEU-SOL- THERM-006 (5 cases)
Materials/ Fissionable Material	Fissionable Element	Uranium	Uranium	Uranium	Uranium	Uranium
	Physical Form	Aqueous solution of uranyl sulfate	UF4 compound with polytetra- fluoroethylene	Aqueous solution of uranyl nitrate	Aqueous solution of uranyl nitrate	Aqueous solution of uranyl nitrate
	Isotopic Composition	20.9 wt. % ²³⁵ U	29.83 wt. % ²³⁵ U	10 wt. % ²³⁵ U	9.97 wt. % ²³⁵ U	10 wt. % ²³⁵ U
	Atomic Density (atoms/b-cm)	²³⁵ U: 1.40e-04 to 2.68e-04 ²³⁸ U: 5.26e-04 to 1.01e-03	²³⁵ U: 2.37e-03 ²³⁸ U: 5.50e-03	²³⁵ U: 4.34e-05 to 7.64e-05 ²³⁸ U: 3.82e-04 to 6.73e-04	²³⁵ U: 5.76e-05 to 7.90e-05 ²³⁸ U: 5.13e-04 to 7.06e-04	²³⁵ U: 1.09e-04 ²³⁸ U: 9.56e-04
	Temperature	Room Temp.	Room Temp.	Room Temp.	Room Temp.	Room Temp.
Materials/ Moderator	Element	H	H; C	H	H	H
	Physical Form	Solution	Polyethylene	Solution	Solution	Solution
	Atomic Density (atoms/b-cm)	5.83e-02 to 6.20e-02	H: 7.5224e-02 C: 3.9232e-02	5.89e-02 to 6.23e-02	5.70e-02 to 5.86e-02	5.77e-02
	Ratio to Fissile Material	217 to 444	Range: H/ ²³⁵ U = 4 to 222	770 to 1438	719 to 1018	532
	Temperature	Room Temp.	Room Temp.	Room Temp.	Room Temp.	Room Temp.
Materials/ Reflector	Material/ Physical Form	Reflected by graphite	Unreflected or reflected by paraffin	Unreflected	Reflected by water	Reflected by water
Materials/ Neutron Absorber	Element	None	B or Cd for some experiments	None	None	B
	Physical Form	N/A	Metallic sheets	N/A	N/A	B ₄ C rods
	Atomic Density (atoms/b-cm)	N/A	Not needed for ROA and ROP comparison	N/A	N/A	Not needed for ROA and ROP comparison
Geometry	Heterogeneity	Homogeneous solution contained in a cylindrical tank	Heterogeneous small cubes of fissile compound interspersed with moderator cubes	Homogeneous solution in a spherical tank	Homogeneous solution in a cylindrical tank	Homogeneous solution in a cylindrical tank
	Shape	Cylinder	Cuboid	Sphere	Cylinder	Cylinder
Neutron Energy	AENCF	0.0149 to 0.0275 MeV	0.0455 to 0.2168 MeV	0.0114 to 0.0186 MeV	0.0142 to 0.0188 MeV	0.0245 to 0.0257 MeV
	EALF	4.96e-02 to 7.93e-02 eV	0.11 to 9.09 eV	3.46e-02 to 4.14e-02 eV	3.75e-02 to 4.21e-02 eV	4.86e-02 to 4.99e-02 eV
	Neutron Energy Spectra ^a	T: 19.3 to 29.3% I: 31.5 to 35.2% F: 39.2 to 45.5%	T: 1.8 to 22.8% I: 24.9 to 40.2% F: 49.6 to 63%	T: 37.6 to 49.1% I: 22.7 to 27.3% F: 28.2 to 35.1%	T: 36.8 to 43.1% I: 25.3 to 27.8% F: 31.6 to 35.4%	T: 26 to 31.2% I: 30 to 30.5% F: 38.8 to 43.5%
	Fission Rate vs. Neutron Energy ^a	T: 90.7 to 94.6% I: 4.7 to 8.1% F: 0.7 to 1.2%	T: 47.5 to 90.9% I: 7.1 to 42.8% F: 2.0 to 11.1%	T: 96.2 to 97.6% I: 2 to 3.1% F: 0.4 to 0.7%	T: 96.1 to 97.0% I: 2.5 to 3.2% F: 0.5 to 0.7%	T: 94.7 to 95.0% I: 4.1 to 4.3% F: 0.9 to 1.0%

Source: BSC 2002 and NEA 2001, Spectra

NOTE: ^aSpectral range defined as follows: thermal (T) [0 to 1 eV], intermediate (I) [1eV to 100 keV], fast (F) [100 keV to 20 MeV].

Table V-8. Range of Applicability of Critical Benchmark Experiments Selected for Comparison with Homogeneous Moderated Configurations of Enrico Fermi SNF (Set 2)

Category/ Description	Parameter	Experiment LEU-SOL- THERM-007 (5 cases)	Experiment LEU-SOL- THERM-008 (4 cases)	Experiment LEU-SOL- THERM-009 (3 cases)	Experiment LEU-SOL- THERM-010 (4 cases)	Experiment LEU-SOL- THERM-016 (7 cases)
Materials/ Fissionable Material	Fissionable Element	Uranium	Uranium	Uranium	Uranium	Uranium
	Physical Form	Aqueous solution of uranyl nitrate	Aqueous solution of uranyl nitrate	Aqueous solution of uranyl nitrate	Aqueous solution of uranyl nitrate	Aqueous solution of uranyl nitrate
	Isotopic Composition	9.97 wt. % ²³⁸ U	9.97 wt. % ²³⁵ U	9.97 wt. % ²³⁵ U	9.97 wt. % ²³⁵ U	9.97 wt. % ²³⁵ U
	Atomic Density (atoms/b-cm)	²³⁵ U: 6.18e-05 to 8.00e-05 ²³⁸ U: 5.5e-04 to 7.12e-04	²³⁵ U: 6.14e-05 to 6.13e-05 ²³⁸ U: 5.47e-04 to 5.49e-04	²³⁵ U: 6.26e-05 to 6.25e-06 ²³⁸ U: 5.57e-04 to 5.58e-04	²³⁵ U: 6.18e-05 to 6.21e-05 ²³⁸ U: 5.51e-04 to 5.54e-04	²³⁵ U: 7.65e-5 to 1.19e-04 ²³⁸ U: 6.82e-04 to 1.06e-03
	Temperature	Room Temp.	Room Temp.	Room Temp.	Room Temp.	Room Temp.
Materials/ Moderator	Element	H	H	H	H	H
	Physical Form	Solution	Solution	Solution	Solution	Solution
	Atomic Density (atoms/b-cm)	5.67e-02 to 5.82e-02	5.86e-02	5.85e-02	5.85e-02	5.56e-02 to 5.91e-02
	Ratio to Fissile Material	709 to 942	951 to 956	934 to 936	942 to 946	469 to 772
	Temperature	Room Temp.	Room Temp.	Room Temp.	Room Temp.	Room Temp.
Materials/ Reflector	Material/ Physical Form	Unreflected	Reflected by concrete	Reflected by borated concrete	Reflected by polyethylene	Reflected by water
Materials/ Neutron Absorber	Element	None	None	None	None	None
	Physical Form	N/A	N/A	N/A	N/A	N/A
	Atomic Density (atoms/b-cm)	N/A	N/A	N/A	N/A	N/A
Geometry	Heterogeneity	Homogeneous solution contained in a cylindrical tank	Homogeneous solution contained in a cylindrical tank	Homogeneous solution contained in a cylindrical tank	Homogeneous solution in a cylindrical tank	Homogeneous solution in a rectangular slab tank
	Shape	Cylinder	Cylinder	Cylinder	Cylinder	Rectangular slab
Neutron Energy	AENCF	0.0159 to 0.0200 MeV	0.0152 to 0.0154 MeV	0.0155 to 0.0158 MeV	0.0153 to 0.0154 MeV	0.0180 to 0.0267 MeV
	EALF	3.87e-02 to 4.28e-02 eV	3.84e-02 to 3.85e-02 eV	3.89e-02 eV	3.84e-02 eV	4.15e-02 to 5.22e-02 eV
	Neutron Energy Spectra^a	T: 35.9 to 41.1% I: 26 to 28.1% F: 32.9 to 36%	T: 41.5 to 41.7% I: 25.9 to 26% F: 32.4 to 35%	T: 40.8 to 4 I: 26.2 to 26.3% F: 32.8 to 32.9%	T: 41.6% I: 25.8 to 25.9% F: 32.5 to 32.6%	T: 29.1 to 37.7% I: 27.7 to 31.2% F: 34.7 to to 39.7%
	Fission Rate vs. Neutron Energy^a	T: 95.9 to 96.7% I: 2.7 to 3.4% F: 0.6 to 0.7%	T: 96.8% I: 2.6% to 2.8% F: 0.6%	T: 96.7% I: 2.7% F: 0.6%	T: 96.8% I: 2.6% F: 0.6%	T: 94.3 to 96.2% I: 3.2 to 4.6% F: 0.7 to 1.0%

Source: BSC 2002 and NEA 2001, Spectra

NOTE: ^aSpectral range defined as follows: thermal (T) [0 to 1 eV], intermediate (I) [1eV to 100 keV], fast (F) [100 keV to 20 MeV].

Table V-9. Range of Applicability of Critical Benchmark Experiments Selected for Comparison with Homogeneous Moderated Configurations of Enrico Fermi SNF (Set 3)

Category/ Description	Parameter	Experiment LEU-SOL- THERM-017 (6 cases)	Experiment LEU-SOL- THERM-018 (6 cases)	Experiment LEU-SOL- THERM-019 (6 cases)	Experiment LEU-SOL- THERM-020 (4 cases)	Experiment LEU-SOL- THERM-021 (4 cases)
Materials/ Fissionable Material	Fissionable Element	Uranium	Uranium	Uranium	Uranium	Uranium
	Physical Form	Aqueous solution of uranyl nitrate	Aqueous solution of uranyl nitrate	Aqueous solution of uranyl nitrate	Aqueous solution of uranyl nitrate	Aqueous solution of uranyl nitrate
	Isotopic Composition	9.97 wt. % ²³⁵ U	9.97 wt. % ²³⁵ U	9.97 wt. % ²³⁵ U	9.97 wt. % ²³⁵ U	9.97 wt. % ²³⁵ U
	Atomic Density (atoms/b-cm)	²³⁵ U: 8.05e-05 to 1.19e-04 ²³⁸ U: 7.17e-04 to 1.06e-03	²³⁵ U: 7.87e-5 to 8.04e-05 ²³⁸ U: 7.01e-04 to -7.16e-04	²³⁵ U: 8.07e-05 to 8.13e-05 ²³⁸ U: 7.19e-04 to 7.24e-04	²³⁵ U: 4.95e-05 to 6.21e-05 ²³⁸ U: 4.41e-04 to 5.53e-04	²³⁵ U: 4.95e-5 to 6.21e-05 ²³⁸ U: 4.41e-04 to 5.53e-04
	Temperature	Room Temp.	Room Temp.	Room Temp.	Room Temp.	Room Temp.
Materials/ Moderator	Element	H	H	H	H	H
	Physical Form	Solution	Solution	Solution	Solution	Solution
	Atomic Density (atoms/b-cm)	5.56e-02 to 5.87e-02	5.87e-02 to 5.91e-02	5.87e-02	6.03e-02 to 6.13e-02	6.03e-02 to 6.13e-02
	Ratio to Fissile Material	469 to 729	731 to 751	721 to 728	971 to 1239	971 to 1239
	Temperature	Room Temp.	Room Temp.	Room Temp.	Room Temp.	Room Temp.
Materials/ Reflector	Material/ Physical Form	Unreflected	Reflected by concrete	Reflected by polyethylene	Reflected by water	Unreflected
Materials/ Neutron Absorber	Element	None	None	None	None	None
	Physical Form	N/A	N/A	N/A	N/A	N/A
	Atomic Density (atoms/b-cm)	N/A	N/A	N/A	N/A	N/A
Geometry	Heterogeneity	Homogeneous solution in a rectangular slab tank	Homogeneous solution in a rectangular slab tank	Homogeneous solution in a rectangular slab tank	Homogeneous solution in a cylindrical tank	Homogeneous solution in a cylindrical tank
	Shape	Rectangular slab	Rectangular slab	Rectangular slab	Cylinder	Cylinder
Neutron Energy	AENCF	0.0192 to 0.0275 MeV	0.0183 to 0.0188 MeV	0.0189 to 0.0191 MeV	0.0125 to 0.0150 MeV	0.0127 to 0.0154 MeV
	EALF	4.24e-02 to 5.23e-02 eV	0.042-0.0425 eV	Not available	Not available	Not available
	Neutron Energy Spectra ^a	T: 28.9 to 36.5% I: 28 to 31.1% F: 35.5 to 40.0%	T: 36.5 - 37.0 % I: 28.0 - 28.3 % F: 34.9 - 35.2 %	Not available	Not available	Not available
	Fission Rate vs. Neutron Energy ^a	T: 94.3 to 96.0% I: 3.3 to 4.6% F: 0.7 to 1.0%	T: 96.0% I: 3.3% F: 0.7	Not available	Not available	Not available

Source: BSC 2002 and NEA 2001, Spectra

NOTE: ^aSpectral range defined as follows: thermal (T) [0 to 1 eV], intermediate (I) [1eV to 100 keV], fast (F) [100 keV to 20 MeV].

V.3 CALCULATION OF THE LOWER-BOUND TOLERANCE LIMIT

The following results are excerpted from *Analysis of Critical Benchmark Experiments and Critical Limit Calculation for DOE SNF* (BSC 2003b) which present in detail the methodology and calculations performed for evaluating the LBTL for each set of configurations of the waste package containing Enrico Fermi SNF. The calculated k_{eff} values for the critical benchmarks are taken from *Analysis of Critical Benchmark Experiments and Critical Limit Calculation for DOE SNF* (BSC 2003b, Attachment II). The results of the trending parameter analysis for the critical benchmark subset representative for moderated intact configurations of the waste package containing Enrico Fermi SNF are presented in Table V-10. The parameters in the following tables describe the regression statistics for the linear trend evaluations (see Attachment III for definitions). The P-value parameter gives a direct estimation of the probability of having a linear trending due to chance only.

Table V-10. Trending Parameter Results for the Critical Benchmark Subset Representative for Moderated Intact (Heterogeneous) Configurations of the Waste Package Containing Enrico Fermi SNF

Trend Parameter	n	Intercept	Slope	r^2	T	$t_{0.025,n-2}$	P-Value	Goodness-of-Fit Tests	Valid Trend
AENCF	63	1.0005	-0.0214	0.0376	-1.5430	1.960	0.1280	Failed	No
Enrichment ($^{235}\text{U}/\text{U}$)	63	0.9990	-3.4E-06	2.24E-04	-0.1169	1.960	0.9073	Failed	No
$\text{H}/^{235}\text{U}$	57	0.9976	1.51E-05	0.0697	2.0295	1.960	0.0473	Failed	No

Source: BSC 2003b, p. 39

Figure V-2 presents the k_{eff} values and the calculated LBTL. The LBTL value calculated with the DFTL method for this subset (the normality test failed) is 0.9751 (BSC 2003b, Attachment I).

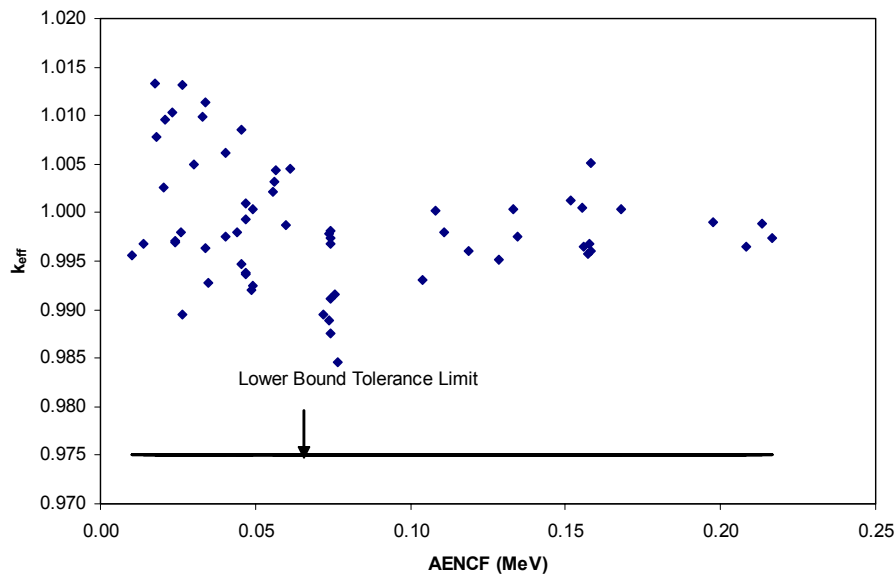

Figure V-2. Lower-Bound Tolerance Limit Applicable for Enrico Fermi SNF Intact (Heterogeneous) Moderated Configurations

The results of the trending parameter analysis for the critical benchmark subset representative for nonmoderated intact configurations of the waste package containing Enrico Fermi SNF are presented in Table V-11.

Table V-11. Trending Parameter Results for the Critical Benchmark Subset Representative for Nonmoderated Intact Fuel (Heterogeneous) Configurations of the Waste Package Containing Enrico Fermi SNF

Trend Parameter	n	Intercept	Slope	r ²	T	t _{0.025,n-2}	P-Value	Goodness-of-Fit Tests	Valid Trend
AENCF	13	1.0132	-6.26E-03	0.0325	-0.6082	2.201	0.5554	Failed	No

Source: BSC 2003b, p. 40

Figure V-3 presents the k_{eff} values and the calculated LBTL. The LBTL value calculated with NDTL method for this subset (the normality test passed) is 0.9872 (BSC 2003b, Attachment I).

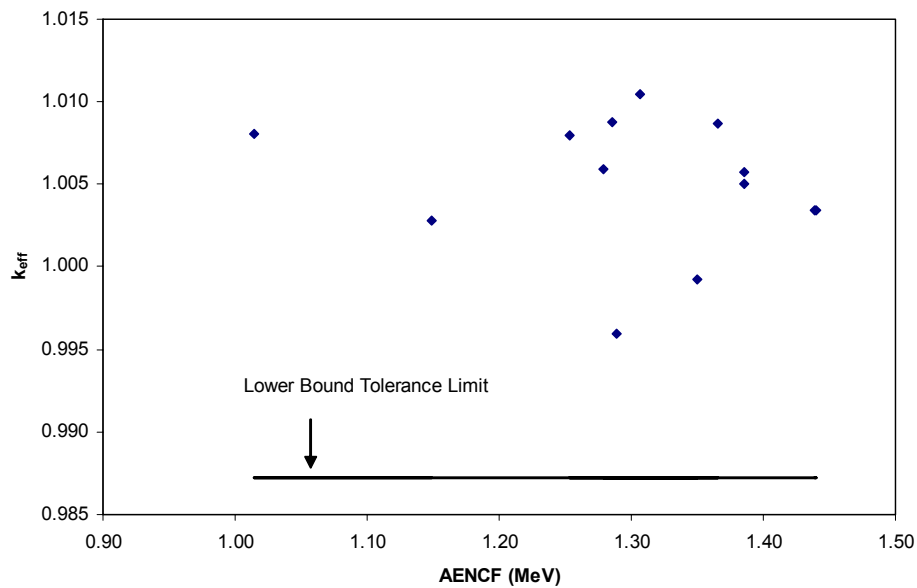

Figure V-3. Lower-Bound Tolerance Limit Applicable for Enrico Fermi SNF for Intact (Heterogeneous) Nonmoderated Configurations

The results of the trending parameter analysis for the critical benchmark subset representative for moderated degraded configurations of the waste package containing Enrico Fermi SNF are presented in Table V-12.

Table V-12. Trending Parameter Results for the Critical Benchmark Subset Representative for Moderated Degraded (Homogeneous) Configurations of the Waste Package Containing Enrico Fermi SNF

Trend Parameter	n	Intercept	Slope	r ²	T	t _{0.025,n-2}	P-Value	Goodness-of-Fit Tests	Valid Trend
AENCF	103	1.0018	-0.0218	0.0369	-1.9659	1.960	0.0521	Failed	No
Enrichment (²³⁵ U/U)	103	1.0048	-2.5E-04	0.1300	-3.8842	1.960	1.84E-04	Failed	No
H/ ²³⁵ U	103	0.9984	3.93E-06	0.0664	2.6792	1.960	8.618E-03	Failed	No

Source: BSC 2003b, p. 41

Figure V-4 presents the k_{eff} values and the calculated LBTL. The LBTL value calculated with the DFTL method for this subset (the normality test failed) is 0.9659 (BSC 2003b, Attachment I).

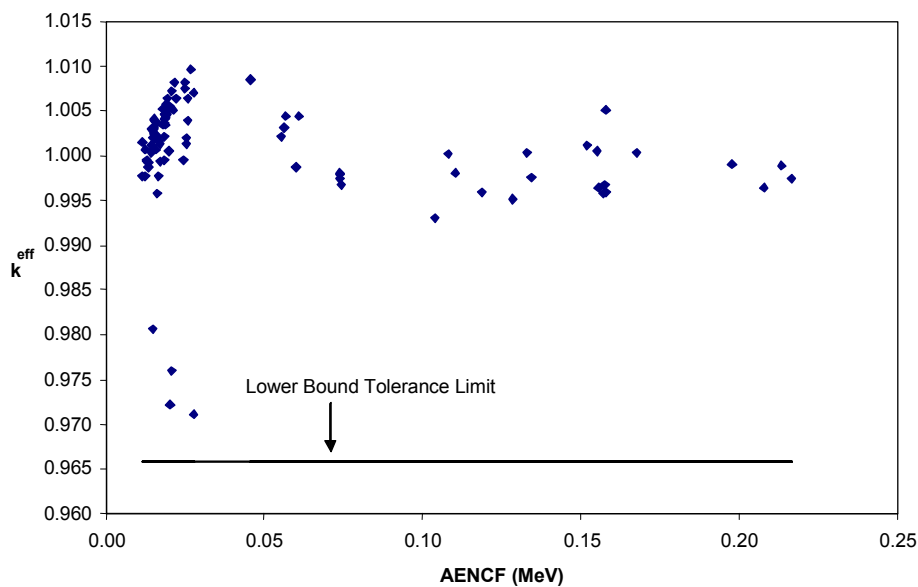

Figure V-4. Lower-Bound Tolerance Limit Applicable for Enrico Fermi SNF for Degraded (Homogeneous) Moderated Configurations

Table V-13 presents a summary of the results of the analyses performed on the subsets of critical benchmark experiments applicable to the waste package containing Enrico Fermi SNF and the calculated LBTL values.

Table V-13. Lower-Bound Tolerance Limits for Benchmark Subsets Representative for the Configurations of the Waste Package Containing Enrico Fermi SNF

Subset	Trend Parameter	Test for Normality	Applied Computational Method	Lower-Bound Tolerance Limit or Lower-Bound Tolerance Limit Function
Intact (Heterogeneous) Moderated	None	Failed	DFTL	CL = 0.9751
Intact (Heterogeneous) Nonmoderated	None	Passed	NDTL	CL = 0.9872
Degraded (Homogeneous) Moderated	None	Failed	DFTL	CL = 0.9659

Source: BSC 2003b, p. 43

INTENTIONALLY LEFT BLANK

ATTACHMENT VI
LBTL CALCULATION AND ROA DETERMINATION FOR N-REACTOR

ATTACHMENT VI

LBTL CALCULATION AND ROA DETERMINATION FOR N-REACTOR

VI.1 INTRODUCTION

This attachment presents the calculations of LBTL and the determination of ROA for benchmarks that could potentially be applicable to waste package configurations containing N-Reactor SNF. A listing of corroborating and supporting data, models, or information used for the calculation is provided in Table VI-1.

Table VI-1. Supporting Information and Sources

Description	Source
Guidance for benchmarking of a calculational method	Dean and Tayloe 2001
Criticality benchmark experiments, tending parameters, and CL calculations	BSC 2002; BSC 2003b; NEA 2001, and CRWMS M&O 1999a
N-Reactor summary report	CRWMS M&O 2001

The N-Reactor SNF is representative of the uranium metal (U-metal) group. This group is one of nine representative fuel groups designated by the National Spent Nuclear Fuel Program for disposal criticality analyses based on the fuel matrix composition, primary fissile isotope and enrichment (DOE 2002, Sections 5.2 and 5.3).

The following information regarding N-Reactor SNF is collected from *Evaluation of Codisposal Viability for U-Metal (N Reactor) DOE-Owned Fuel* (CRWMS M&O 2001, Section 2.1.3). The N-Reactor fuels are composed of zirconium cladding and a low-enriched uranium metal fuel matrix. The N-Reactor fuel elements consist of the two basic design variants, both of which use two concentric tubes of uranium metal co-extruded with Zircaloy-2 cladding. The N-Reactor core was fueled with low enriched (0.947 wt. %, and 0.947 to 1.25 wt. % ²³⁵U in Mark IV and Mark IA fuels, respectively) uranium metal. Differences in the enrichment were selected based on the intended mode of reactor operation (i.e., plutonium or power production). Table VI-2 presents the main characteristics of the N-Reactor fuel elements.

Table VI-2. N-Reactor Fresh Fuel Elements Description

Fuel type	Mark IV				Mark IA		
Preirradiation enrichment of ²³⁵ U	0.947% enriched				0.947% and 1.25% enriched for the inner and outer cylinders of the fuel element, respectively		
Type-length code ^a	E	S	A	C	M	T	FF
Length, cm (in.)	66 (26.1)	62 (24.6)	59 (23.2)	44 (17.4)	53b (20.9)	50 (19.6)	38 (14.9)
Element Diameter, mm (in.)							
1. Outer of outer fuel element	61.47	(2.42)			60.96	(2.40)	
2. Inner of outer fuel element	43.18	(1.70)			44.96	(1.77)	
3. Outer of inner fuel element	32.51	(1.28)			31.75	(1.25)	
4. Inner of inner fuel element	12.19	(0.48)			11.18	(0.44)	
Cladding weight, kg (lb.)							
1. Outer element	1.094 (2.41)	1.041 (2.29)	0.991 (2.18)	0.791 (1.74)	0.882 (1.94)	0.832 (1.83)	0.659 (1.45)
2. Inner element	0.550 (1.21)	0.523 (1.15)	0.500 (1.10)	0.400 (0.88)	0.536 (1.18)	0.509 (1.12)	0.405 (0.89)
Weight of uranium in outer fuel element							
1. 0.947% ²³⁵ U, kg (lb.)	16.0 (35.2)	15.0 (33.1)	14.2 (31.2)	10.5 (23.1)	N/A		
2. 1.25% ²³⁵ U, kg (lb.)	N/A				11.1 (24.4)	10.4 (22.9)	7.9 (17.3)
Uranium isotopics	(0.947 wt. %)				(1.25 wt. %)		
²³⁵ U	0.9470				1.2500		
²³⁶ U	0.0392				0.0392		
²³⁸ U	99.0138				98.7108		
Weight of uranium in inner fuel element kg @ 0.947% ²³⁵ U, (lb.)	7.5 (16.5)	7.0 (15.5)	6.6 (14.6)	5.0 (10.9)	5.5 (12.1)	5.1 (11.3)	3.9 (8.6)
Maximum weight of a fuel element, kg (lb.)	25.15 (55.32)	23.65 (52.04)	22.31 (49.08)	16.65 (36.62)	18.01 (39.62)	16.89 (37.15)	12.84 (28.24)
Weighted average of uranium in a fuel element, kg (lb.)	22.73 (50.0)				16.32 (35.9)		
Ratio of Zircaloy-2 to uranium, kg/MT	140	141.6	143.2	154.1	171.0	172.5	180.7

Source: CRWMS M&O 2001, p. 2-6

NOTES: ^aLetter code differentiates the various lengths of Mark IV or Mark IA fuel elements (i.e., a type “E” element is 26.1 inches long).

^bThere are 12 Mark IA elements with an overall length of 66.3 cm; they will be considered as a special case fuel loading in a Mark IV fuel basket.

The current conceptual design for disposing of N-Reactor SNF (CRWMS M&O 2001, Section 2.1.4) in the repository contains two defense high-level radioactive waste canisters and two multiccanister overpacks (MCO) loaded with N-Reactor spent nuclear fuel. It should be noted that this waste package configuration differs from the other DOE spent nuclear fuel types,

which have five defense high-level radioactive waste canisters surrounding a single DOE SNF canister.

The canister design (CRWMS M&O 2001, p. 2-9) includes a nominal length of 4198.37 mm (165.29 in.) and a maximum outer diameter of 642.9 mm (25.31 in.) Beyond these basic dimensions, fuel-specific internals have been designed for each canister based on the known maximum lengths of the fuels (Mark IV or IA) contained therein. In addition, a central process post constructed out of Stainless Steel Type 304L is present in the MCOs. This central post is associated with the stacked baskets, and each post is drilled to facilitate water removal from the bottom of the MCO after underwater loading. In the case of the Mark IV fuel and scrap baskets, the post outer diameter is 7.20 cm (2.835 in.) with a 1.37 cm (0.54 in.) thick wall. The Mark IA fuel and scrap baskets use a 16.83 cm (6.625 in.) post diameter and a 4.458 cm (1.755 in.[max.]) drilled hole in the center for a 6.18 cm (2.435 in.) wall thickness.

Five baskets containing Mark IV spent nuclear fuel are placed in the MCO. The two top and bottom baskets may be scrap baskets (baskets containing various-sized pieces of SNF). A similar arrangement but with six baskets is possible for the MCO containing Mark IA SNF (CRWMS M&O 2001, Sections 2.1.4.2 and 2.1.4.3). Based on the preliminary criticality analyses no neutron absorber is necessary to be added for the current design configuration (CRWMS M&O 2001, Section 8.7).

Figure VI-1 presents a simplified cross section of the waste package containing 2 MCOs placed in a waste package (CRWMS M&O 2001, p. 2-3).

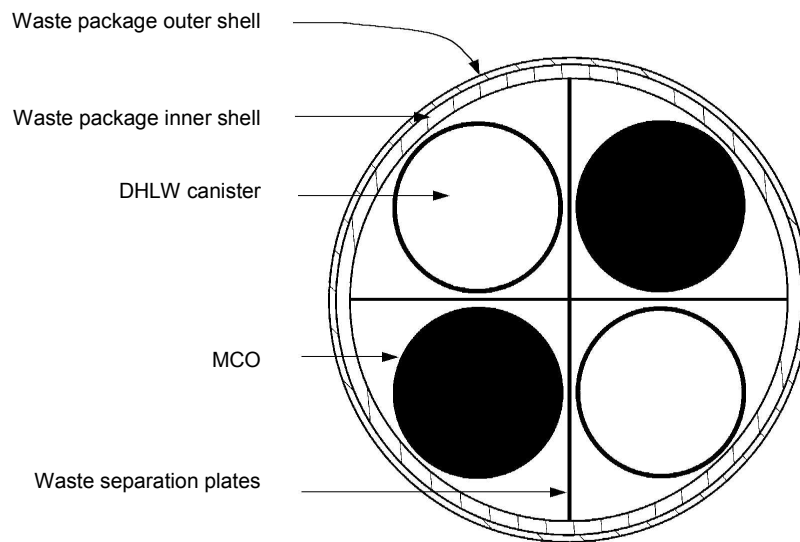

Figure VI-1. Cross Section of the Waste Package Containing N-Reactor SNF

VI.2 SELECTION OF THE CRITICALITY BENCHMARK EXPERIMENTS

The critical experiments selected for inclusion in benchmarking must be representative of the types of materials, conditions, and parameters to be represented using the calculational method. A sufficient number of experiments with varying experimental parameters should be selected for inclusion in the benchmarking to ensure as wide an area of applicability as feasible and statistically significant results. While there is no absolute guideline for the minimum number of critical experiments necessary to benchmark a computational method, the use of only a few (i.e., less than 10) experiments should be accompanied by a suitable technical basis supporting the rationale for acceptability of the results (Dean and Tayloe 2001, p. 5).

For the present application (codisposal of N-Reactor SNF), the selected benchmark experiments have been grouped in two subsets (BSC 2002, Section 6.1.8) that include moderated heterogeneous and homogeneous experiments. The benchmark experiments come from *International Handbook of Evaluated Criticality Safety Benchmark Experiments* (NEA 2001), unless otherwise noted. The selection process was initially based on prior knowledge regarding the possible degraded configurations of the waste packages (CRWMS M&O 2001, Section 7), and the subsets have been constructed to accommodate large variations in the range of parameters of the configurations and to provide adequate statistics for LBTL calculations. The selected benchmark experiments for each subset are presented in *Benchmark and Critical Limit Calculation for DOE SNF* (BSC 2002) with MCNP cases constructed and calculation results. The cases, k_{eff} results, and their uncertainties are also summarized in *Analysis of Critical Benchmark Experiments and Critical Limit Calculation for DOE SNF* (BSC 2003b, Attachment II). Table VI-3 presents the list of the benchmark experiments and the number of cases for each subset selected for N-Reactor SNF.

Table VI-3. Critical Benchmarks Selected for N-Reactor SNF

Subset	Benchmark Experiment Identification ^b	No. of Cases Included
Heterogeneous moderated ^c	Experiment with N-reactor Mark IA Fuel Elements	3
	LEU-COMP-THERM-001	8
	LEU-COMP-THERM-016 ^a	4
	LEU-COMP-THERM-010 ^a	3
	LEU-COMP-THERM-042	7
Homogeneous moderated ^c	Experiment with LEU UO3-H2O solutions	12
	LEU-SOL-THERM-001	1
	LEU-SOL-THERM-002	3
	LEU-SOL-THERM-005	3
	LEU-COMP-THERM-049	18

Source: Subsets defined and evaluated in BSC 2002

NOTES: ^aOnly the cases evaluated in CRWMS M&O 1999a have been used.

^bThe convention for naming the benchmark experiments is from NEA 2001.

^cIdentification of each subset from BSC 2002 has been modified to better reflect the subset's main characteristics. The benchmark experiments in each subset have not been affected.

The experiments cover configuration classes IP-1a, IP-1b, IP-2a, IP-3a, IP-3b, IP-3c, and IP-3b for the degraded waste package containing N-Reactor SNF as described in Section 7.

VI.2.1 Range of Applicability of Selected Critical Benchmark Experiments

This section summarizes in a set of tables (Tables VI-4 and VI-5) the range of applicability of the experiments listed in Table VI-3. The information is partly excerpted from *Benchmark and Critical Limit Calculation for DOE SNF* (BSC 2002, Section 6.2) which presents a less comprehensive set of parameters. The tables have been enhanced by adding information regarding the spectral characteristics of the experiments (available for the majority of the benchmarks in NEA [2001]). The purpose is to construct a collective area of applicability that will be used to directly compare with the range of parameters of the codisposal configurations.

Table VI-4. Range of Applicability of Critical Benchmark Experiments Selected for Comparison With Heterogeneous Moderated Configurations of N-Reactor SNF

Category/ Description	Parameter	Experiment with N-reactor MkIA fuel elements (3 cases)	Experiment LEU-COMP- THERM-001 (8 cases)	Experiment LEU-COMP- THERM-016 (4 cases)	Experiment LEU-COMP- THERM-010 (3 cases)	Experiment LEU-COMP- THERM-042 (7 cases)
Materials/ Fissionable Material	Fissionable Element	Uranium	Uranium	Uranium	Uranium	Uranium
	Physical Form	U metal	UO ₂	UO ₂	UO ₂	UO ₂
	Isotopic Composition	0.947 wt. % ²³⁵ U (inner cylinder) 1.25 wt. % ²³⁵ U (outer cylinder)	2.35 wt. % ²³⁵ U	2.35 wt. % ²³⁵ U	4.31 wt. % ²³⁵ U	2.35 wt. % ²³⁵ U
	Atomic Density (atoms/b-cm)	²³⁵ U:4.56e-04 (inner cylinder) ²³⁵ U:6.04e-04 (outer cylinder)	²³⁵ U: 4.88e-04	²³⁵ U: 4.88e-04	²³⁵ U: 1.01e-03	²³⁵ U: 4.88e-04
	Temperature	Room Temp.	Room Temp.	Room Temp.	Room Temp.	Room Temp.
Materials/ Moderator	Element	H	H	H	H	H
	Physical Form	Water	Water	Water	Water	Water
	Atomic Density (atoms/b-cm)	6.67e-02	6.67e-02	6.67e-02	6.67e-02	6.67e-02
	Ratio to Fissile Material (In Region Containing Fissile Material)	994 to 1876	449 to 487	449 to 487	Not available	Not available
	Temperature	Room Temp.	Room Temp.	Room Temp.	Room Temp.	Room Temp.
Materials/ Reflector	Material/ Physical Form	Reflected by water	Reflected by water	Reflected by water	Reflected by water, lead, uranium, and steel	Reflected by water and steel
	Element	None	None	B	None	B, Cd
Materials/ Neutron Absorber	Physical Form	N/A	N/A	B, C (boral)	N/A	Plates
	Atomic Density (atoms/b-cm)	N/A	N/A	Not needed for ROA and ROP comparison	N/A	Not needed for ROA and ROP comparison

Table VI-4. Range of Applicability of Critical Benchmark Experiments Selected for Comparison With Heterogeneous Moderated Configurations of N-Reactor SNF (Continued)

Category/Description	Parameter	Experiment with N-reactor MkIA fuel elements (3 cases)	Experiment LEU-COMP-THERM-001 (8 cases)	Experiment LEU-COMP-THERM-016 (4 cases)	Experiment LEU-COMP-THERM-010 (3 cases)	Experiment LEU-COMP-THERM-042 (7 cases)
Geometry	Heterogeneity	Heterogeneous complex lattice	Square pitched clusters in a rectangular geometry	Square pitched clusters in a rectangular geometry	Square pitched clusters in a rectangular geometry	Square pitched clusters in a rectangular geometry
	Shape		Parallel-piped	Parallel-piped	Parallel-piped	Parallel-piped
Neutron Energy	AENCF	0.3145 MeV to 0.4085 MeV	0.11186 to 0.1239 MeV	0.1201 to 0.1229 MeV	0.1778 to 0.2839 MeV	0.1690 to 0.1750 MeV
	EALF	Not available	0.109 to 0.113 eV	0.01 to 0.114 eV	0.325 to 0.821 eV	Not available
	Neutron Energy Spectra ^a	Not available	T: 29.3 to 31.6% I: 28.8 to 29.9% F: 39.6 to 40.8%	T: 26.6 to 40.3% I: 27.6 to 31.2% F: 33.9 to 42.6%	T: 19.6 to 20.7% I: 31.7 to 33.9% F: 44.2 to 46.8%	Not available
	Fission Rate vs. Neutron Energy ^a	Not available	T: 91.3 to 91.6% I: 4.4 to 4.6% F: 4.0 to 4.1%	T: 91.2 to 91.5% I: 4.5 to 4.7% F: 4.0 to 4.1%	T: 79.2 to 82.9% I: 10.9 to 12.1% F: 6.2 to 10.4%	Not available

Source: BSC 2002 and NEA 2001, Spectra

NOTE: ^a Spectral range defined as follows: thermal (T) [0 to 1 eV], intermediate (I) [1eV to 100 keV], fast (F) [100 keV to 20 MeV].

Table VI-5. Range of Applicability of Critical Benchmark Experiments Selected for Comparison With Homogeneous Moderated Configurations of N-Reactor SNF

Category/Description	Parameter	Experiments with LEU-UO ₃ -H ₂ O solutions (12 cases)	Experiment LEU-SOL-THERM-001 (1 case)	Experiment LEU-SOL-THERM-002 (3 cases)	Experiment LEU-SOL-THERM-005 (3 cases)	Experiment LEU-COMP-THERM-049 (18 cases)
Materials/Fissionable Material	Fissionable Element	Uranium	Uranium	Uranium	Uranium	Uranium
	Physical Form	Aqueous solution of UO ₃	Aqueous solution of uranyl fluoride	Aqueous solution of uranium oxy-fluoride	Aqueous solution of uranyl nitrate	UO ₂
	Isotopic Composition	1.0059 to 1.1586 wt. % ²³⁵ U	5 wt. % ²³⁵ U	4.9 wt. % ²³⁵ U	5.64 wt. % ²³⁵ U	5 wt. % ²³⁵ U
	Atomic Density (atoms/b-cm)	²³⁵ U: 2.99e-05 to 3.97e-05 ²³⁸ U: 2.91e-03 to 3.72e-03	²³⁵ U: 1.24e-4 ²³⁸ U: 2.35e-3	²³⁵ U: 5.67e-05 to 6.16e-05 ²³⁸ U: 1.09e-03 to 1.18e-03	²³⁵ U: 5.783e-05 ²³⁸ U: 9.55e-04	²³⁵ U: 3.69e-4 ²³⁸ U: 6.94e-03
	Temperature	Room Temp.	Room Temp.	Room Temp.	Room Temp.	Room Temp.
Materials/Moderator	Element	H	H	H	H	H
	Physical Form	Solution	Solution	Solution	Solution	Solution
	Atomic Density (atoms/b-cm)	1.26e-02 to 2.19e-02	5.62e-02	6.17e-0 to 6.22e-02	5.62e-02	1.47e-0 to 2.20e-02
	Ratio to Fissile Material	370 to 731	454	1,001 to 10,098	972	2 to 3
	Temperature	Room Temp.	Room Temp.	Room Temp.	Room Temp.	Room Temp.

Table VI-5. Range of Applicability of Critical Benchmark Experiments Selected for Comparison With Homogeneous Moderated Configurations of N-Reactor SNF (Continued)

Category/Description	Parameter	Experiments with LEU-UO ₃ -H ₂ O solutions (12 cases)	Experiment LEU-SOL-THERM-001 (1 case)	Experiment LEU-SOL-THERM-002 (3 cases)	Experiment LEU-SOL-THERM-005 (3 cases)	Experiment LEU-COMP-THERM-049 (18 cases)
Materials/Reflector	Material/Physical Form	Unreflected	Unreflected	Unreflected or reflected by water	Reflected by water	Reflected by polyethylene
Materials/Neutron Absorber	Element	None	None	None	B	None
	Physical Form	N/A	N/A	N/A	B ₄ C rods	N/A
	Atomic Density (atoms/b-cm)	N/A	N/A	N/A	Not needed for ROA and ROP comparison	N/A
Geometry	Heterogeneity	Homogeneous solution in a single spherical vessel	Homogeneous solution in a cylindrical vessel	Homogeneous solution in a spherical vessel	Homogeneous solution in a cylindrical tank	Array of boxes in rectangular geometry
	Shape	Sphere	Cylinder	Sphere	Cylinder	Parallel-piped
Neutron Energy	AENCF	0.1549 to 0.2541 MeV	0.0519 MeV	0.0251 to 0.0283 MeV	0.0254 to 0.0260 MeV	0.2270 to 0.3000 MeV
	EALF	Not available	0.0629 eV	0.0395 to 0.0416 eV	0.0412 to 0.0415 eV	0.899 to 2.78 eV
	Neutron Energy Spectra ^a	Not available	T: 28.6% I: 31.2% F: 40.2%	T: 43.9 to 45.5% I: 24.1 to 25.3% F: 30.4 to 32.1%	T: 30.2 to 41.2% I: 26.2 to 27.7% F: 32.6 to 42.1%	T: 7.1 to 15.0 % I: 38.6 to 41.0 % F: 46.2 to 51.9 %
	Fission Rate vs. Neutron Energy ^a	Not available	T: 93.6% I: 4.6% F: 1.8%	T: 96.6 to 96.9% I: 2.3 to 2.5% F: 0.8 to 1.1%	T: 96.4% I: 2.7% F: 0.9%	T: 63.2 to 72.9 % I: 19.0 to 25.9 % F: 8.1 to 10.9 %

Source: BSC 2002 and NEA 2001, Spectra

NOTE: ^a Spectral range defined as follows: thermal (T) [0 to 1 eV], intermediate (I) [1eV to 100 keV], fast (F) [100 keV to 20 MeV].

VI.3 CALCULATION OF THE LOWER-BOUND TOLERANCE LIMIT

The following results are excerpted from *Analysis of Critical Benchmark Experiments and Critical Limit Calculation for DOE SNF* (BSC 2003b) which present in detail the methodology and calculations performed for evaluating the LBTL for each set of configurations of the waste package containing N-Reactor SNF. The calculated k_{eff} values for the critical benchmarks are taken from *Analysis of Critical Benchmark Experiments and Critical Limit Calculation for DOE SNF* (BSC 2003b, Attachment II). The results of the trending parameter analysis for the critical benchmark subset representative for moderated intact (heterogeneous) configurations of the waste package containing N-Reactor SNF are presented in Table VI-6. The parameters in the following tables describe the regression statistics for the linear trend evaluations (see Attachment III for definitions). The P-value parameter gives a direct estimation of the probability of having a linear trending due to chance only.

Table VI-6. Trending Parameter Results for the Critical Benchmark Subset Representative for Moderated Intact (Heterogeneous) Configurations of the Waste Package Containing N-Reactor SNF

Trend Parameter	n	Intercept	Slope	r ²	T	t _{0.025,n-2}	P-Value	Goodness-of-Fit Tests	Valid Trend
AENCF	25	0.9866	0.0765	0.3775	3.7349	2.069	0.0011	Passed	Yes
Enrichment (²³⁵ U/U)	25	1.0140	-0.0057	0.2062	-2.4441	2.069	0.0226	Failed	No

Source: BSC 2003b, p. 57

Figure VI-2 presents the k_{eff} values and the calculated LBTL. Details for the calculation of the LBTL function are provided in *Analysis of Critical Benchmark Experiments and Critical Limit Calculation for DOE SNF* (BSC 2003b, Attachment I) with the results as follows:

$$\text{Lower-bound tolerance limit} = 0.0765 \times \text{AENCF} + 0.9434 \text{ for } 0 \text{ MeV} < \text{AENCF} < 0.175 \text{ MeV}$$

$$\text{Lower-bound tolerance limit} = 0.9568 \text{ for } \text{AENCF} > 0.175 \text{ MeV}$$

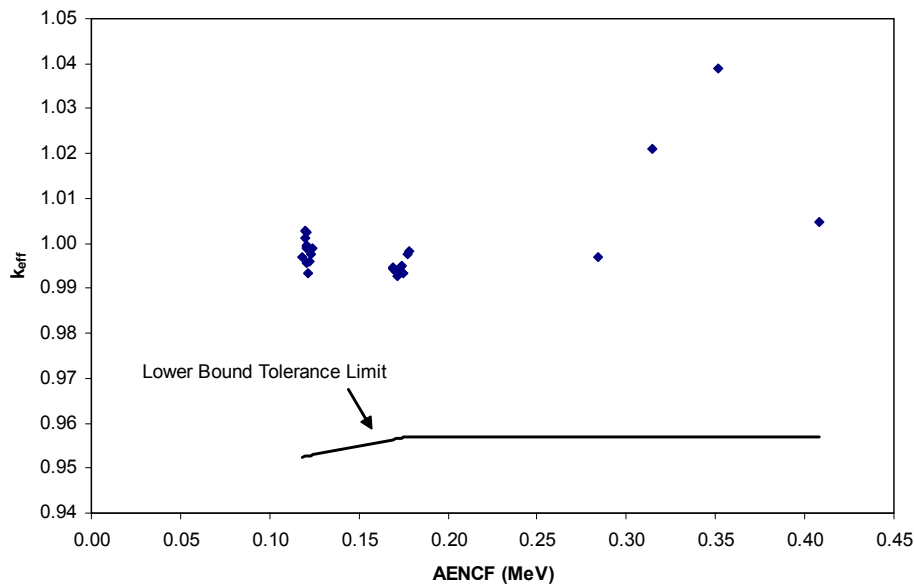

Figure VI-2. Lower-Bound Tolerance Limit Applicable for N-Reactor SNF for Intact (Heterogeneous) Moderated Configurations

The results of the trending parameter analysis for the critical benchmark subset representative for moderated degraded configurations of the waste package containing N-Reactor SNF are presented in Table VI-7.

Table VI-7. Trending Parameter Results for the Critical Benchmark Subset Representative for Moderated Degraded Configurations of the Waste Package Containing N-Reactor SNF

Trend Parameter	n	Intercept	Slope	r ²	T	t _{0.025,n-2}	P-Value	Goodness-of-Fit Tests	Valid Trend
AENCF	37	1.0012	-0.0215	0.1478	-2.4635	1.960	0.0188	Failed	No
Enrichment (²³⁵ U/U)	37	1.0017	-1.25E-03	0.2261	-3.1975	1.960	2.938E-03	Failed	No
H/X	31	0.9956	4.66E-06	0.1148	1.9394	1.960	0.0622	Failed	No

Source: BSC 2003b, p. 58

Figure VI-3 presents the k_{eff} values and the calculated LBTL. The LBTL value calculated with DFTL method for this subset (normality test failed) is 0.9748 (BSC 2003b, Attachment I).

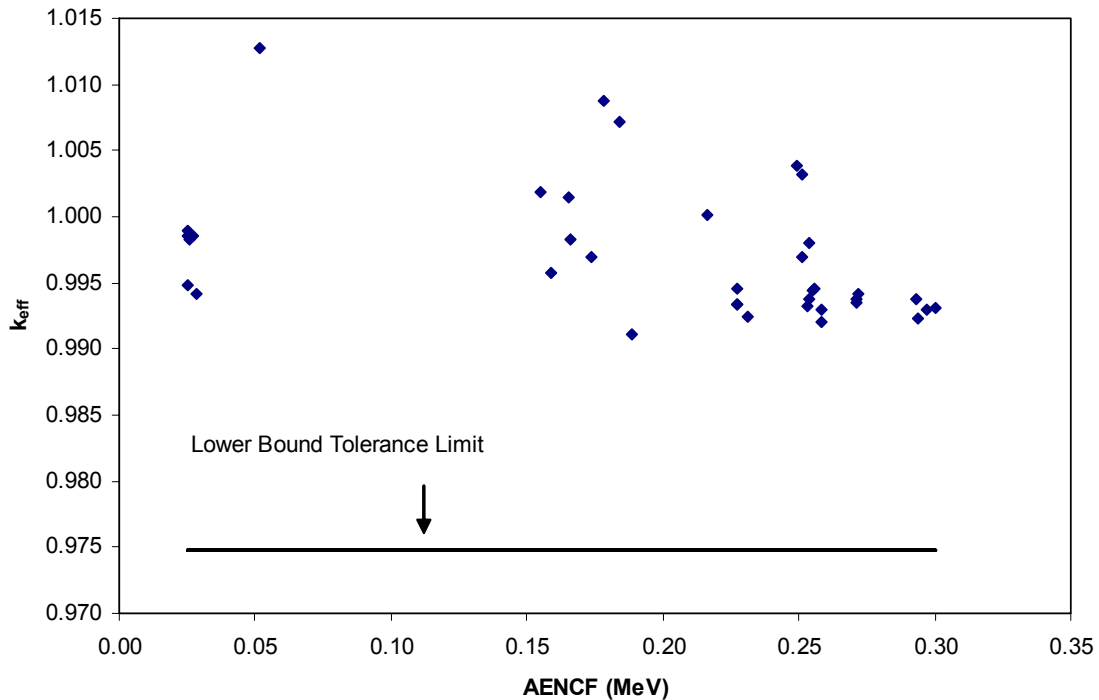

Figure VI-3. Lower-Bound Tolerance Limit Applicable for N-Reactor SNF for Degraded (Homogeneous) Moderated Configurations

Table VI-8 presents a summary of the results of the analyses performed on the subsets of critical benchmark experiments applicable to the waste package containing N-Reactor SNF and the calculated LBTL values.

Table VI-8. Lower-Bound Tolerance Limits for Benchmark Subsets Representative for the Configurations of the Waste Package Containing N-Reactor SNF

Subset	Trend Parameter (x)	Test for Normality	Applied Computational Method	Lower-Bound Tolerance Limit Values or Functions
Intact (heterogeneous) Moderated	AENCF	N/A	LUTB	$f(\text{AENCF}) = 0.0765 \times \text{AENCF} + 0.9434$ for $0 < \text{AENCF} < 0.175$ $f(\text{AENCF}) = 0.9568$ for $\text{AENCF} > 0.175$
Degraded (homogeneous) Moderated	None	Failed	DFTL	0.9748

Source: BSC 2003b, p. 59

ATTACHMENT VII
LBTL CALCULATION AND ROA DETERMINATION FOR FFTF

ATTACHMENT VII

LBTL CALCULATION AND ROA DETERMINATION FOR FFTF

VII.1 INTRODUCTION

This attachment presents the calculations of the LBTL and the determination of ROA for benchmarks that could potentially be applicable to waste package configurations containing Fast Flux Test Facility (FFTF) SNF. A listing of corroborating and supporting data, models, or information used for the calculation is provided in Table VII-1.

Table VII-1. Supporting Information and Sources

Description	Source
Guidance for benchmarking a calculational method	Dean and Tayloe 2001
Criticality benchmark experiments, trending parameters, and CL calculations	BSC 2002; BSC 2003b; NEA 2001
FFTF summary report	CRWMS M&O 1999f

FFTF fuel is the representative fuel for the mixed-oxide (MOX) fuel group, which is a mixture of uranium and plutonium oxides. This group is one of nine representative fuel groups designated by the National Spent Nuclear Fuel Program for disposal criticality analyses based on the fuel matrix composition, primary fissile isotope and enrichment (DOE 2002, Sections 5.2 and 5.3).

The following information regarding FFTF SNF characteristics is collected from *Evaluation of Codisposal Viability for MOX (FFTF) DOE-Owned Fuel* (CRWMS M&O 1999f, Section 2.1.4), unless otherwise noted. The FFTF standard driver fuel assembly (DFA) contains 217 cylindrical fuel pins and is hexagonally shaped. The assembly is 3,657.6 mm long. The overall height of a fuel pin is 2,372.36 mm for Types 3.1 and 4.1 fuel pins, and 2377.44 mm for Types 3.2 and 4.2 fuel pins (Figure VII-1). The Stainless Steel Type 316 cladding is 0.381 mm (0.015 in.) thick. The inner and outer diameters of the cladding are 5.08 mm (0.200 in.) and 5.842 mm (0.230 in.), respectively. Each fuel pin has a 914.4-mm (36-in.) long fuel region containing fuel pellets with an outer diameter of 4.9403 mm (0.1945 in.). Each fuel pin is helically wrapped with a 1.4224 mm (0.056 in.) diameter Stainless Steel Type 316 wire to provide lateral spacing along its length. The fuel pins are arranged with a triangular pitch within the hexagonal duct. The fuel density is reported as 90.4 percent of the theoretical density, which corresponds to a fuel density of 10.02 g/cm³. The mixed oxide (MOX – UO_{1.96} and PuO_{1.96}) fuel region is followed by 20.32 mm (0.8 in.) of natural UO₂ insulator pellets and 144.78 mm (5.7 in.) of Inconel 600 reflector on each end. The density of natural uranium insulator pellets is 10.42 ± 0.22 g/cm³.

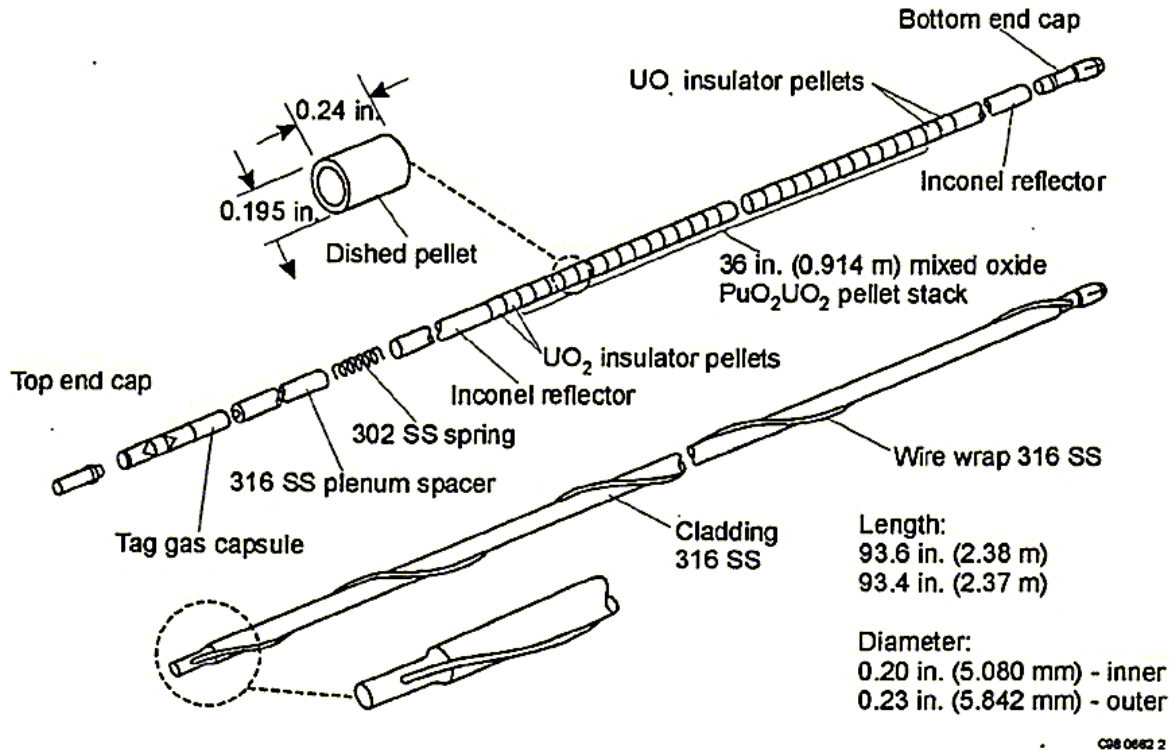

Figure VII-1. Simplified Axial View of a Standard FFTF Driver Fuel Assembly Fuel Pin

Above the top reflector is a Stainless Steel Type 302 spring (125.5 mm long by 0.8052 mm in diameter) and a Stainless Steel Type 316 plenum (862.1 mm long with a 4.9022 mm outer diameter). The maximum stainless steel spring volume is 2.7264 cm^3 . The fuel pin is closed with top and bottom caps having a 5.842 mm diameter. The length of the top cap is 104.6 mm. The bottom cap length for Type 3.1 and 4.1 fuels is 35.6 mm. The bottom cap length for Type 3.2 and 4.2 fuels is 40.6 mm. Each fuel pin weighs 455 g (approximately 1 lb). The fuel enrichments and isotopic fractions for all four types of fresh FFTF fuel are provided in Table VII-2. Note that Types 3.1 and 4.1 fuel pins have similar dimensions and Types 3.2 and 4.2 fuel pins have the same dimensions.

The driver fuel assembly (DFA) comprises a hexagonal duct that surrounds the fuel pins, discriminator, inlet nozzle, neutron shield and flow orifice region, load pads, and handling socket. The duct is stainless steel Type 316 with a wall thickness of 3.048 mm (0.12 in.). The duct-tube outer dimension is 116.205 mm (4.575 in.) across the hexagonal flats and 131.064 mm (5.16 in.) across the opposite hexagonal points. The fuel pin pitch is 7.2644 mm (0.286 in.). The maximum assembly width is determined by the load pads, which are 138.1125 mm (5.4375 in.) across the opposite hexagonal points. The assembly is 3657.6 mm (144 in.) high. The total weight of a DFA is 172.819 kg (approximately 381 lb).

Some of the assemblies have been disassembled and the fuel pins placed in fuel pin (Ident-69) containers. Although there are several types of pin containers, the most reactive one is the compartmented representation (Figure VII-2), which can hold up to 217 fuel pins (CRWMS M&O 1999f, Section 2.1.4). The total container length is 3,657.6 mm (144 in.). The Ident-69

containers are made with 5-in. Stainless Steel Type 304L pipe (actual diameter is 5.563 in. or 141.30 mm) with a transition to 2.5-in. pipe (actual diameter is 2.875 in. or 73.02 mm) at 431.8 mm (17 in.) from the bottom. The inside diameter of the container is 135.763 mm (5.345 in.). The fuel pins are supported on a grid plate with 1.5875-mm (0.0625-in.) diameter holes. The central compartment has inside and outside radii of 20.701 mm (0.815 in.) and 22.225 mm (0.875 in.), respectively. The divider plates have the same thickness as the center tube. The empty weight of an Ident-69 pin container is 59.09 kg (130 lb). A cross section of a partially loaded fuel pin container is shown in Figure VII-2.

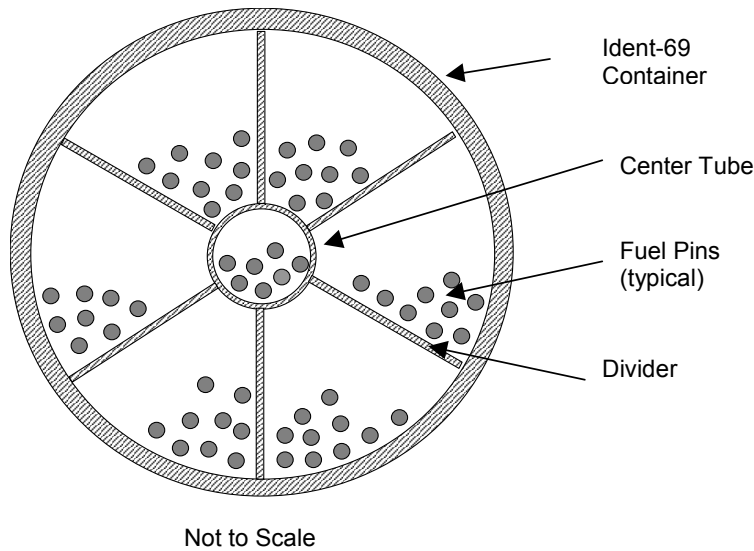

Figure VII-2. Cross-Section of a Partially Loaded Ident-69 Fuel Pin Container (Compartmented Representation)

Table VII-2. Uranium and Plutonium Content of Fresh Driver Fuel Assembly

		Driver Fuel Type			
		3.1	3.2	4.1	4.2
Plutonium					
Content (wt. % Pu/[Pu+U])		27.37	22.43	29.28	25.14
Pu mass in assembly (kg)		9.071	7.421	9.722	8.333
Pu mass in pin (g)		41.8	34.2	44.8	38.4
Isotopic fraction					
	²³⁹ Pu	0.8696	0.8696	0.8711	0.8711
	²⁴⁰ Pu	0.1173	0.1173	0.1163	0.1163
	²⁴¹ Pu	0.0104	0.0104	0.0102	0.0102
Uranium					
Content (wt. % U/[Pu+U])		72.63	77.57	70.72	74.86
U mass in assembly (kg)		24.070	25.666	23.481	24.813
U mass in pin (g)		110.9	118.3	108.2	114.3
Isotopic fraction					
	²³⁵ U	0.007	0.007	0.002	0.002
	²³⁸ U	0.993	0.993	0.998	0.998

Source: CRWMS M&O 1999f, Table 2-4

NOTE: Each assembly nominally holds 1.5 kg of U in insulator pellets.

Some of the Ident-69 containers contain experimental MOX fuel pins that have a larger diameter (0.69 cm).

The waste package configuration that holds the DOE SNF canister with FFTF (MOX) SNF also contains five high-level radioactive waste (HLW) glass pour canisters and a carbon steel basket. The FFTF SNF canister is placed in a carbon-steel support tube located in the center of the waste package (Figure VII-3). The five HLW canisters are evenly spaced around the FFTF SNF canister, which is designed for five intact FFTF fuel assemblies spaced around a center position. The center position will contain either another assembly or a pin container, referred to as Ident-69, which holds up to 217 individual FFTF fuel pins. The Ident-69 can only fit in the center position. The current design solution (CRWMS M&O 1999f, Section 7.6) requires only four DFAs to be loaded when the center position is occupied by the Ident-69 container. The DOE SNF canister basket structure is composed of a cylindrical stainless-steel tube, which occupies the center position and is supported by five equally spaced external divider plates that separate the intact FFTF assemblies from one another in the outer ring.

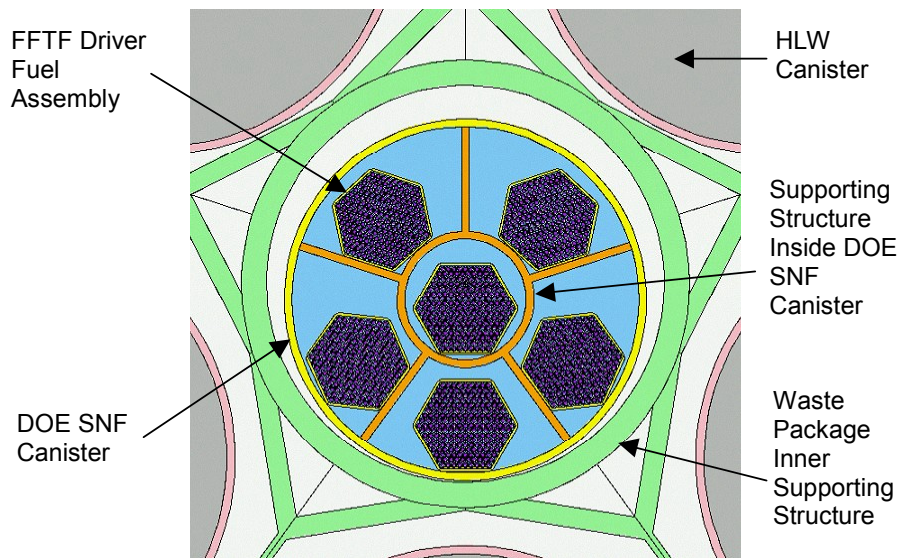

NOTE: DOE SNF = U.S. Department of Energy spent nuclear fuel, FFTF = Fast Flux Test Facility, HLW = high-level radioactive waste.

Figure VII-3. Cross Section of the DOE SNF Canister Containing FFTF SNF Placed Inside Waste Package

VII.2 SELECTION OF THE CRITICALITY BENCHMARK EXPERIMENTS

The critical experiments selected for inclusion in benchmarking must be representative of the types of materials, conditions, and parameters to be represented using the calculational method. A sufficient number of experiments with varying experimental parameters should be selected for inclusion in the benchmarking to ensure as wide an area of applicability as feasible and statistically significant results. While there is no absolute guideline for the minimum number of critical experiments necessary to benchmark a computational method, the use of only a few (i.e., less than 10) experiments should be accompanied by a suitable technical basis supporting the rationale for acceptability of the results (Dean and Tayloe 2001, p. 5).

For the present application (codisposal of FFTF SNF), the selected benchmark experiments are included in one subset in *Benchmark and Critical Limit Calculation for DOE SNF* (BSC 2002, Section 6.1.5) as moderated heterogeneous experiments. The benchmark experiments are from *International Handbook of Evaluated Criticality Safety Benchmark Experiments* (NEA 2001), unless otherwise noted. The selection process was initially based on prior knowledge regarding the possible degraded configurations of the waste package (CRWMS M&O 1999f, Section 7), and the subset has been constructed to accommodate large variations in the range of parameters of the configurations and to provide adequate statistics for the LBTL calculations. The selected benchmark experiments for the subset are presented in *Benchmark and Critical Limit Calculation for DOE SNF* (BSC 2002) with MCNP cases constructed and calculation results. The cases, k_{eff} results, and their uncertainties are also summarized in *Analysis of Critical Benchmark Experiments and Critical Limit Calculation for DOE SNF* (BSC 2003b, Attachment II). Table VII-3 presents the list of the benchmark experiments and the number of cases for the subset selected for FFTF SNF.

Table VII-3. Critical Benchmarks Selected for FFTF SNF

Subset	Benchmark Experiment Identification ^a	No. of Cases Included
Heterogeneous Moderated ^b	MIX-COMP-THERM-001	4
	MIX-COMP-THERM-003	6
	MIX-COMP-THERM-004	11
	MIX-COMP-THERM-010	11

Source: Subset defined and evaluated in BSC 2002, Section 5

NOTES: ^aThe convention for naming the benchmark experiments is from NEA 2001.

^bIdentification of subset from BSC 2002 has been modified to better reflect the subset's main characteristics. The benchmark experiments in the subset have not been affected.

The FFTF SNF configuration class that the experiments are considered to cover is IP-1a as described in Section 7 for the degraded waste package containing FFTF SNF.

VII.3 Range of Applicability of Selected Critical Benchmark Experiments

This section summarizes in Table VII-4 the range of applicability of the experiments listed in Table VII-3. The information is partly excerpted from *Benchmark and Critical Limit Calculation for DOE SNF* (BSC 2002, Table 6-17), which presents a less comprehensive set of parameters. The tables have been enhanced by adding information regarding the spectral characteristics of the experiments (available for the majority of the benchmarks in *International Handbook of Evaluated Criticality Safety Benchmark Experiments* [NEA 2001]) to construct a collective area of applicability to directly compare with the range of parameters of codisposal configurations.

Table VII-4. Range of Applicability of Critical Benchmark Experiments Selected for Comparison with Heterogeneous Moderated Configurations of FFTF SNF

Category/Description	Parameter	Experiment MIX-COMP-THERM-001 (4 cases)	Experiment MIX-COMP-THERM-003 (6 cases)	Experiment MIX-COMP-THERM-004 (11 cases)	Experiment MIX-COMP-THERM-010 (11 cases)
Materials/ Fissionable Material	Fissionable Element	Plutonium + Uranium	Plutonium + Uranium	Plutonium + Uranium	Plutonium + Uranium
	Physical Form	PuO ₂ +UO ₂	PuO ₂ +UO ₂	PuO ₂ +UO ₂	PuO ₂ +UO ₂ and U-Pu nitrate solution
	Isotopic Composition	19.70 wt. % Pu in pellets 85.5 wt. % ²³⁹ Pu in Pu 2.5 wt. % ²⁴¹ Pu in Pu Natural U in UO ₂	5.8 wt. % Pu in pellets (6.6 wt. % PuO ₂) 90.5 wt. % ²³⁹ Pu in Pu 0.89 wt. % ²⁴¹ Pu in Pu Natural U in UO ₂	3.01 wt. % PuO ₂ in pellets 68.2 wt. % ²³⁹ Pu in Pu 7.26 wt. % ²⁴¹ Pu in Pu Natural U in UO ₂	In Pellets 19.8 wt. % Pu in pellets 86.6 wt. % ²³⁹ Pu in Pu 1.45 wt. % ²⁴¹ Pu in Pu Natural U in UO ₂ Solution Pu/(U+Pu)=0.22 (weight ratio) 91.1 wt. % ²³⁹ Pu in Pu 0.4 wt. % ²⁴¹ Pu in Pu Natural U in solution
	Atomic Density (atoms/b-cm)	²³⁹ Pu: 4.20e-03 ²⁴¹ Pu: 8.75e-05 ²³⁵ U: 1.22e-04	²³⁹ Pu: 1.35e-03 ²⁴¹ Pu: 1.14e-05 ²³⁵ U: 1.53e-04	²³⁹ Pu: 2.75e-04 ²⁴¹ Pu: 2.42e-05 ²³⁵ U: 9.39e-05	In pellets ²³⁹ Pu: 4.24e-03 ²⁴¹ Pu: 4.11e-05 ²³⁵ U: 1.22e-04 In solution ²³⁹ Pu: 2.02e-06 to 2.38e-04 ²⁴¹ Pu: 9.21e-09 to 1.09e-06 ²³⁵ U: 4.89e-08 to 6.59e-06
	Temperature	Room Temp.	Room Temp.	Room Temp.	Room Temp.
Materials/ Moderator	Element	H	H	H	H
	Physical Form	Water	Water	Water	Pu-U nitrate solution
	Atomic Density (atoms/b-cm)	6.67e-02	6.66e-02 to 6.68e-02	6.67e-02	5.54e-02 to 6.61e-02
	Ratio to Fissile Material (In Region Containing Fissile Material)	Range: H/X= 50.4 to 265 ^b (X include ²³⁵ U, ²³⁹ Pu and ²⁴¹ Pu)	Range: H/X= 74 to 473 ^b (X include ²³⁵ U, ²³⁹ Pu and ²⁴¹ Pu)	Range: H/X= 411 to 945 ^b (X include ²³⁵ U, ²³⁹ Pu and ²⁴¹ Pu)	Not available
	Temperature	Room Temp.	Room Temp.	Room Temp.	Room Temp.
Materials/ Reflector	Material/ Physical Form	Reflected by water	Reflected by water	Reflected by water	Reflected by water and carbon steel
Materials/ Neutron Absorber	Element	None	None	None	Gd for 5 cases
	Physical Form	N/A	N/A	N/A	Gd in Pu-U nitrate solution
	Atomic Density (atoms/b-cm)	N/A	N/A	N/A	1.88e-06 to 8.27e-06
Geometry	Heterogeneity	Heterogeneous square pitched lattice of pins (pitch: 0.9525 to 1.905 cm)	Heterogeneous square pitched lattice of pins (pitch: 1.3208 to 2.6416 cm)	Heterogeneous square pitched lattice of pins (pitch: 1.825 to 2.474 cm)	Heterogeneous cylindrical square pitched lattice of pins (pitch = 1.4 cm)
	Shape	Parallel-piped	Parallel-piped	Parallel-piped	Cylinder
Neutron Energy	AENCF	0.0635 to 0.1717 MeV	0.08 to 0.2294 MeV	0.0747 to 0.1218 MeV	0.033 to 0.153 MeV
	EALF	0.12 to 1.07 eV	0.103 to 0.922 eV	0.082 to 0.149 eV	Not available
	Neutron Energy Spectra ^a	T: 5.6 to 23% I: 28.8 to 37.1% F: 48.2 to 57.3%	T: 6.9 to 27.1% I: 27.4 to 38% F: 45.5 to 55.1%	T: 20.1 to 33.2% I: 26.9 to 33.3% F: 39.9 to 46.6%	Not available
	Fission Rate vs. Neutron Energy ^a	T: 71.7 to 91.5% I: 5.9 to 20.8% F: 2.6 to 7.5%	T: 75.1 to 93.2% I: 4.0 to 16.4% F: 2.8 to 8.5%	T: 90.6 to 94.7% I: 2.8 to 5.3% F: 2.5 to 4.1%	Not available

Source: BSC 2002; NEA 2001, Spectra

NOTES: ^a Spectral range defined as follows: thermal (T) [0 to 1 eV], intermediate (I) [1eV to 100 keV], fast (F) [100 keV to 20 MeV].

^b Calculated in this report based on unit cell.

^c AENCF = average energy of a neutron causing fission, EALF = energy of average lethargy causing fission.

VII.4 CALCULATION OF THE LOWER-BOUND TOLERANCE LIMIT

The following results are excerpted from *Analysis of Critical Benchmark Experiments and Critical Limit Calculation for DOE SNF* (BSC 2003b), which presents in detail the methodology and calculations performed for evaluating the LBTL for each set of configurations of the waste package containing FFTF SNF. The calculated k_{eff} values for the critical benchmarks are taken from *Analysis of Critical Benchmark Experiments and Critical Limit Calculation for DOE SNF* (BSC 2003b, Attachment II). The results of the trending parameter analysis for the critical benchmark subset representative for moderated intact (heterogeneous) configurations of the waste package containing FFTF SNF are presented in Table VII-5. The parameters in the following tables describe the regression statistics for the linear trend evaluations (see Attachment III for definitions). The P-value parameter gives a direct estimation of the probability of having a linear trending due to chance only.

Table VII-5. Trending Parameter Results for the Critical Benchmark Subset Representative for Moderated Intact Fuel (Heterogeneous) Configurations of the Waste Package Containing FFTF SNF

Trend Parameter	n	Intercept	Slope	r^2	T	$t_{0.025,n-2}$	P-Value	Goodness-of-Fit Tests	Valid Trend
AENCF	32	1.0045	-0.0382	0.1454	-2.2591	1.960	0.0313	Failed	No

Source: BSC 2003b, p. 44

NOTE: AENCF = average energy of a neutron causing fission.

Figure VII-4 presents the k_{eff} values and the calculated LBTL. The LBTL value calculated with DFTL method for this subset (normality test failed) is 0.9786 (BSC 2003b, Attachment I).

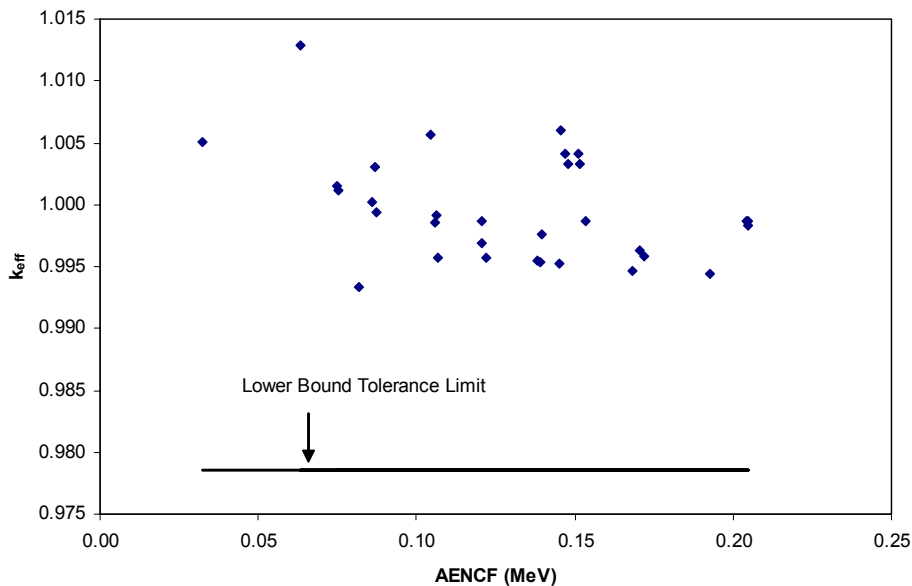

Figure VII-4. Lower-Bound Tolerance Limit Applicable for FFTF DOE SNF for Intact (Heterogeneous) Moderated Configurations

INTENTIONALLY LEFT BLANK

ATTACHMENT VIII
LBTL CALCULATION AND ROA DETERMINATION
FOR MELT AND DILUTE INGOTS

ATTACHMENT VIII

LBTL CALCULATION AND ROA DETERMINATION FOR
MELT AND DILUTE INGOTS

VIII.1 INTRODUCTION

This attachment presents the calculations of the LBTL and the determination of ROA for benchmarks that could potentially be applicable to waste package configurations containing Melt and Dilute ingots. A listing of corroborating and supporting data, models, or information used for the calculation is provided in Table VIII-1.

Table VIII-1. Supporting Information and Sources

Description	Source
Guidance for benchmarking a calculational method	Dean and Tayloe 2001
Criticality benchmark experiments, trending parameters, and CL calculations	BSC 2002; BSC 2003b; NEA 2001
Melt and Dilute summary report	BSC 2001a

NOTE: CL=critical limit.

Melt and Dilute is the representative type of the high-enriched U-Al fuel group. This group is one of nine representative fuel groups designated by the National Spent Nuclear Fuel Program for disposal criticality analyses based on the fuel matrix composition, primary fissile isotope and enrichment (DOE 2002, Sections 5.2 and 5.3).

The following information regarding Melt and Dilute ingots characteristics is collected from *Evaluation of Codisposal Viability for Melt and Dilute DOE-Owned Fuel* (BSC 2001a, Section 2.1.4) unless otherwise indicated. The current Melt and Dilute technology program is focused on the development and implementation of a treatment technology for diluting high-enriched U-Al SNF to low enriched U levels (less than 20 wt. %) and qualifying this low-enriched U-Al SNF form (Melt and Dilute ingots) for geologic repository disposal (BSC 2001a, p. 1-1).

The Melt and Dilute ingots are homogeneous and monolithic cylinders that will range in height from 15 to 30 in (381 mm to 762 mm) and will likely be contained in a plain carbon steel crucible liner. The liner will have the maximum outer diameter of 16.5 in. (419.1 mm). The mass of the Melt and Dilute ingot is dictated by the geometry assumed for a given configuration using an ingot density of approximately 3 g/cm³ and an ingot porosity of 5 to 10 percent. The composition of the ingot is 13.2 plus or minus 5 wt. % uranium, enriched at less than 20 wt. % ²³⁵U and 0.5 wt. % gadolinium metal, with the balance of the ingot being aluminum. A second composition is considered, which is identical to the first for uranium and gadolinium, except that in this case 2.5 wt. % of the ingot is hafnium, with the balance of the ingot being aluminum.

The DOE-standardized canister will contain three to six Melt and Dilute ingots that are homogenous and monolithic, depending on the dimensions of the individual ingots as described above. Figure VIII-1 presents a cross section of the DOE SNF canister containing Melt and Dilute ingots placed in a waste package (BSC 2001a, pp. vii and viii).

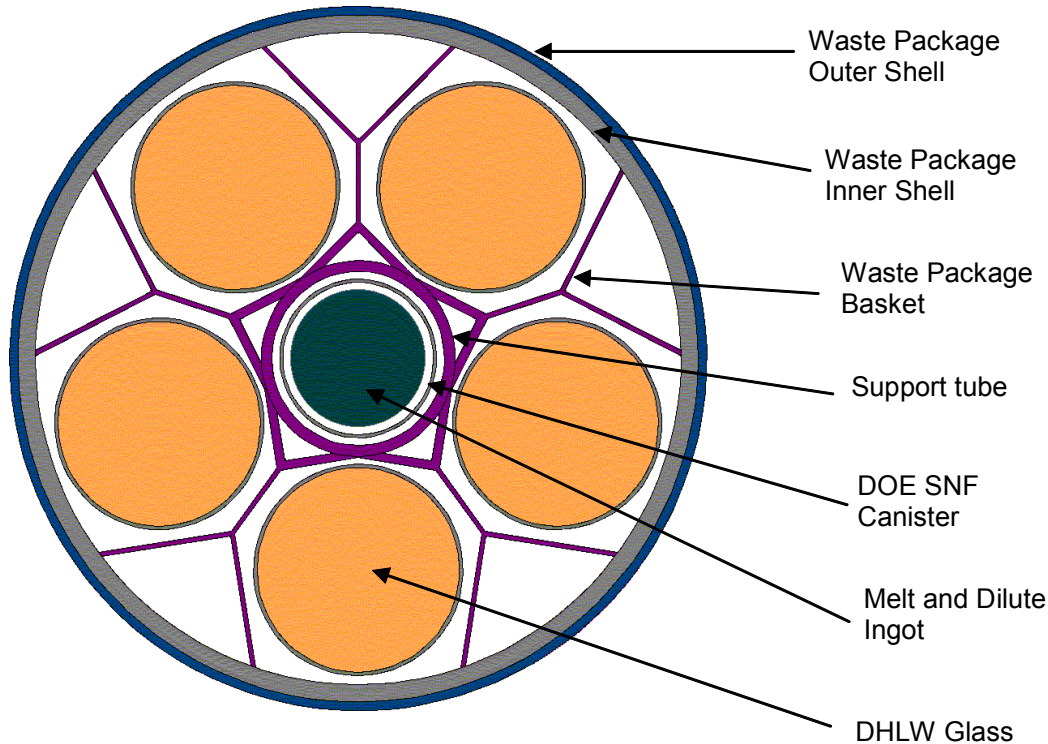

NOTE: DOE SNF = U.S. Department of Energy Spent Nuclear Fuel.

Figure VIII-1. Cross-Section of the DOE SNF Canister Containing Melt and Dilute Ingots Placed Inside Waste Package

VIII.2 SELECTION OF THE CRITICALITY BENCHMARKS

The critical experiments selected for inclusion in benchmarking must be representative of the types of materials, conditions, and parameters to be represented using the calculational method. A sufficient number of experiments with varying experimental parameters should be selected for inclusion in the benchmarking to ensure as wide an area of applicability as feasible and statistically significant results. While there is no absolute guideline for the minimum number of critical experiments necessary to benchmark a computational method, the use of only a few (i.e., less than 10) experiments should be accompanied by a suitable technical basis supporting the rationale for acceptability of the results (Dean and Tayloe 2001, p. 5).

For the present application (codisposal of Melt and Dilute ingots) the selected benchmark experiments are included in one subset in *Benchmark and Critical Limit Calculation for DOE SNF* (BSC 2002, Section 6.1.3) as moderated homogenous experiments. The benchmark experiments are from *International Handbook of Evaluated Criticality Safety Benchmark Experiments* (NEA 2001), unless otherwise noted. The selection process was initially based on prior knowledge regarding the possible degraded configurations of the waste package (BSC 2001a, Section 7), and the subset has been constructed to accommodate large variations in the range of parameters of the configurations and to provide adequate statistics for the lower-bound tolerance limit calculations. The selected benchmark experiments for the subset are presented in

Benchmark and Critical Limit Calculation for DOE SNF (BSC 2002) with MCNP cases constructed and calculation results. The cases, k_{eff} results, and their uncertainties are also summarized in *Analysis of Critical Benchmark Experiments and Critical Limit Calculation for DOE SNF* (BSC 2003b, Attachment II). Table VIII-2 presents the list of the benchmark experiments and the number of cases for the subset selected for FFTF SNF.

Table VIII-2. Critical Benchmarks Selected for Melt and Dilute Ingots

Subset	Benchmark Experiment Identification ^a	No. of Cases Included
Homogeneous Moderated ^b	IEU-SOL-THERM-001	4
	IEU-COMP-THERM-001	29
	LEU-SOL-THERM-003	9
	LEU-SOL-THERM-004	7
	LEU-SOL-THERM-006	5
	LEU-SOL-THERM-007	5
	LEU-SOL-THERM-008	4
	LEU-SOL-THERM-009	3
	LEU-SOL-THERM-010	4
	LEU-SOL-THERM-016	7
	LEU-SOL-THERM-017	6
	LEU-SOL-THERM-018	6
	LEU-SOL-THERM-019	6
	LEU-SOL-THERM-020	4
	LEU-SOL-THERM-021	4

Source: Subset defined in BSC 2002

NOTES: ^aThe convention for naming the benchmark experiments is from NEA 2001.

^bIdentification of subset from BSC 2002 has been modified to better reflect the subset's main characteristics. The benchmark experiments in the subset have not been affected.

The experiments cover configuration class IP-2a for the degraded waste package containing Melt and Dilute ingots as described in Section 7.

VIII.2.1 Range of Applicability of Selected Critical Benchmark Experiments

This section summarizes in a set of tables (Tables VIII-3 to VIII-5) the range of applicability of the experiments listed in Table VIII-2. The information is partly excerpted from *Benchmark and Critical Limit Calculation for DOE SNF* (BSC 2002, Section 6.2), which presents a less comprehensive set of parameters. The tables have been enhanced by adding information regarding the spectral characteristics of the experiments (where available in *International Handbook of Evaluated Criticality Safety Benchmark Experiments* [NEA 2001]) to construct a collective area of applicability that will be used to directly compare with the range of parameters of the codisposal configurations.

Table VIII-3. Range of Applicability of Critical Benchmark Experiments Selected for Comparison with Homogeneous Moderated Configurations of Melt and Dilute Ingots (Set 1)

Category/Description	Parameter	Experiment IEU-SOL-THERM-001 (4 cases)	Experiment IEU-COMP-THERM-001 (29 cases)	Experiment LEU-SOL-THERM-003 (9 cases)	Experiment LEU-SOL-THERM-004 (7 cases)	Experiment LEU-SOL-THERM-006 (5 cases)
Materials/ Fissionable Material	Fissionable Element	Uranium	Uranium	Uranium	Uranium	Uranium
	Physical Form	Aqueous solution of uranyl sulfate	UF ₄ compound with polytetrafluoroethylene	Aqueous solution of uranyl nitrate	Aqueous solution of uranyl nitrate	Aqueous solution of uranyl nitrate
	Isotopic Composition	20.9 wt. % ²³⁵ U	29.83 wt. % ²³⁵ U	10 wt. % ²³⁵ U	9.97 wt. % ²³⁵ U	10 wt. % ²³⁵ U
	Atomic Density (atoms/b-cm)	²³⁵ U: 1.40e-04 to 2.68e-04 ²³⁸ U: 5.26e-04 to 1.01e-03	²³⁵ U: 2.37e-03 ²³⁸ U: 5.50e-03	²³⁵ U: 4.34e-05 to 7.64e-05 ²³⁸ U: 3.82e-04 to 6.73e-04	²³⁵ U: 5.76e-05 to 7.92e-05 ²³⁸ U: 5.13e-04 to 7.06e-04	²³⁵ U: 1.09e-04 ²³⁸ U: 9.56e-04
	Temperature	Room Temp.	Room Temp.	Room Temp.	Room Temp.	Room Temp.
Materials/ Moderator	Element	H	H; C	H	H	H
	Physical Form	Solution	Polyethylene	Solution	Solution	Solution
	Atomic Density (atoms/b-cm)	5.83e-02 to 6.20e-02	H: 7.5224e-02 C: 3.9232e-02	5.89e-02 to 6.23e-02	5.70e-02 to 5.86e-02	5.77e-02
	Ratio to Fissile Material	217 to 444	Range: H/ ²³⁵ U = 4 to 222	770 to 1437	719 to 1018	532
	Temperature	Room Temp.	Room Temp.	Room Temp.	298	293
Materials/ Reflector	Material/ Physical Form	Reflected by graphite	Unreflected or reflected by paraffin	Unreflected	Reflected by water	Reflected by water
Materials/ Neutron Absorber	Element	None	B or Cd for some experiments	None	None	B
	Physical Form	N/A	Metallic sheets	N/A	N/A	B ₂ C rods
	Atomic Density (atoms/b-cm)	N/A	Not needed for ROA and ROP comparison	N/A	N/A	Not needed for ROA and ROP comparison
Geometry	Heterogeneity	Homogeneous solution contained in a cylindrical tank	Heterogeneous small cubes of fissile compound interspersed with moderator cubes	Homogeneous solution in a spherical tank	Homogeneous solution in a cylindrical tank	Homogeneous solution in a cylindrical tank
	Shape	Cylinder	Cuboid	Sphere	Cylinder	Cylinder
Neutron Energy	AENCF ^b	0.0149 to 0.0275 MeV	0.0455 to 0.2168 MeV	0.0114 to 0.0186 MeV	0.0142 to 0.0188 MeV	0.0245 to 0.0257 MeV
	EALF ^b	4.96e-02 to 7.93e-02 eV	0.11 to 9.09 eV	3.46e-02 to 4.14e-02 eV	3.75e-02 to 4.21e-02 eV	4.86e-02 to 4.99e-02 eV
	Neutron Energy Spectra ^a	T: 19.3 to 29.3% I: 31.5 to 35.2% F: 39.2 to 45.5%	T: 1.8 to 22.8% I: 24.9 to 40.2% F: 49.6 to 63%	T: 37.6 to 49.1% I: 22.7-27.3% F: 28.2-35.1%	T: 36.8 to 43.1% I: 25.3-27.8% F: 31.6-35.4%	T: 26 to 31.2% I: 30-30.5% F: 38.8-43.5%
	Fission Rate vs. Neutron Energy ^a	T: 90.7 to 94.6% I: 4.7 to 8.1% F: 0.7 to 1.2%	T: 49.9 to 90.9% I: 7.1 to 42.8% F: 2.5 to 11.1%	T: 96.2 to 97.6% I: 2 to 3.1% F: 0.4 to 0.7%	T: 96.1 to 97.0% I: 2.5 to 3.2% F: 0.5 to 0.7%	T: 94.7 to 95.0% I: 4.1 to 4.3% F: 0.9 to 1.0%

Source: BSC 2002 and NEA 2001, Spectra

NOTES: ^a Spectral range defined as follows: thermal (T) [0 to 1 eV], intermediate (I) [1eV to 100 keV], fast (F) [100 keV to 20 MeV].

^b AENCF = average energy of a neutron causing fission, EALF = energy of average lethargy causing fission.

Table VIII-4. Range of Applicability of Critical Benchmark Experiments Selected for Comparison with Homogeneous Moderated Configurations of Melt and Dilute Ingots (Set 2)

Category/Description	Parameter	Experiment LEU-SOL-THERM-007 (5 cases)	Experiment LEU-SOL-THERM-008 (4 cases)	Experiment LEU-SOL-THERM-009 (3 cases)	Experiment LEU-SOL-THERM-010 (4 cases)	Experiment LEU-SOL-THERM-016 (7 cases)
Materials/ Fissionable Material	Fissionable Element	Uranium	Uranium	Uranium	Uranium	Uranium
	Physical Form	Aqueous solution of uranyl nitrate	Aqueous solution of uranyl nitrate	Aqueous solution of uranyl nitrate	Aqueous solution of uranyl nitrate	Aqueous solution of uranyl nitrate
	Isotopic Composition	9.97 wt. % ²³⁵ U	9.97 wt. % ²³⁵ U	9.97 wt. % ²³⁵ U	9.97 wt. % ²³⁵ U	9.97 wt. % ²³⁵ U
	Atomic Density (atoms/b-cm)	²³⁵ U: 6.18e-05 to 8.00e-05 ²³⁸ U: 5.5e-04 to 7.12e-04	²³⁵ U: 6.13e-05 to 6.16e-05 ²³⁸ U: 5.46e-04b to 5.49e-04	²³⁵ U: 6.25e-05 to 6.26e-05 ²³⁸ U: 5.57e-04 to 5.58e-04	²³⁵ U: 6.18e-05 to 6.21e-05 ²³⁸ U: 5.51e-04 to 5.54e-04	²³⁵ U: 7.65e-5 to 1.19e-04 ²³⁸ U: 6.82e-04 to 1.06e-03
	Temperature	Room Temp.	Room Temp.	Room Temp.	Room Temp.	Room Temp.
Materials/ Moderator	Element	H	H	H	H	H
	Physical Form	Solution	Solution	Solution	Solution	Solution
	Atomic Density (atoms/b-cm)	5.67e-02 to 5.82e-02	5.86e-02	5.85e-02	5.85e-02	5.56e-02 to 5.91e-02
	Ratio to Fissile Material	709 to 942	951 to 956	934 to 936	942 to 946	469 to 772
	Temperature	Room Temp.	Room Temp.	Room Temp.	Room Temp.	Room Temp.
Materials/ Reflector	Material/ Physical Form	Unreflected	Reflected by concrete	Reflected by borated concrete	Reflected by polyethylene	Reflected by water
Materials/ Neutron Absorber	Element	None	None	None	None	None
	Physical Form	N/A	N/A	N/A	N/A	N/A
	Atomic Density (atoms/b-cm)	N/A	N/A	N/A	N/A	N/A
Geometry	Heterogeneity	Homogeneous solution contained in a cylindrical tank	Homogeneous solution contained in a cylindrical tank	Homogeneous solution contained in a cylindrical tank	Homogeneous solution in a cylindrical tank	Homogeneous solution in a rectangular slab tank
	Shape	Cylinder	Cylinder	Cylinder	Cylinder	Rectangular slab
Neutron Energy	AENCF ^b	0.0159 to 0.0200 MeV	0.0152 to 0.0154 MeV	0.0155 to 0.0158 MeV	0.0153 to 0.0154 MeV	0.0180 to 0.0267 MeV
	EALF ^b	3.87e-02 to 4.28e-02 eV	3.84e-02 to 3.85e-02 eV	3.89e-02 eV	3.84e-02 eV	4.15e-02 to 5.22e-02 eV
	Neutron Energy Spectra ^a	T:35.9 to 41.1% I: 26 to 28.1% F:32.9 to 36%	T: 41.5 to 41.7% I: 25.9 to 26% F: 32.4 to 35%	T: 40.8 to 41% I: 26.2 to 26.3% F: 32.8 to 32.9%	T: 41.6% I: 25.8 to 25.9% F: 32.5 to 32.6%	T:29.1 to 37.7% I: 27.7 to 31.2% F: 34.7 to 39.7%
	Fission Rate vs. Neutron Energy ^a	T: 95.9 to 96.7% I: 2.7 to 3.4% F: 0.6 to 0.7%	T: 96.8% I: 2.6% to 2.8% F: 0.6%	T: 96.7% I: 2.7% F: 0.6%	T: 96.8% I: 2.6% F: 0.6%	T: 94.3 to 96.2% I: 3.2 to 4.6% F: 0.7 to 1.0%

Source: BSC 2002 and NEA 2001, Spectra

NOTES: ^aSpectral range defined as follows: thermal (T) [0 to 1 eV], intermediate (I) [1eV to 100 keV], fast (F) [100 keV to 20 MeV].

^bAENCF = average energy of a neutron causing fission, EALF = energy of average lethargy causing fission.

Table VIII-5. Range of Applicability of Critical Benchmark Experiments Selected for Comparison with Homogeneous Moderated Configurations of Melt and Dilute Ingots (Set 3)

Category/Description	Parameter	Experiment LEU-SOL-THERM-017 (6 cases)	Experiment LEU-SOL-THERM-018 (6 cases)	Experiment LEU-SOL-THERM-019 (6 cases)	Experiment LEU-SOL-THERM-020 (4 cases)	Experiment LEU-SOL-THERM-021 (4 cases)
Materials/ Fissionable Material	Fissionable Element	Uranium	Uranium	Uranium	Uranium	Uranium
	Physical Form	Aqueous solution of uranyl nitrate	Aqueous solution of uranyl nitrate	Aqueous solution of uranyl nitrate	Aqueous solution of uranyl nitrate	Aqueous solution of uranyl nitrate
	Isotopic Composition	9.97 wt. % ²³⁵ U	9.97 wt. % ²³⁵ U	9.97 wt. % ²³⁵ U	9.97 wt. % ²³⁵ U	9.97 wt. % ²³⁵ U
	Atomic Density (atoms/b-cm)	²³⁵ U: 8.05e-05 to 1.19e-04 ²³⁸ U: 7.17e-04 to 1.06e-03	²³⁵ U: 7.87e-5 to 8.04e-05 ²³⁸ U: 7.01e-04 to 7.16e-04	²³⁵ U: 8.07e-05 to 8.13e-05 ²³⁸ U: 7.19e-04 to 7.24e-04	²³⁵ U: 4.95e-05 to 6.21e-05 ²³⁸ U: 4.41e-04 to 5.53e-04	²³⁵ U: 4.95e-5 to 6.21e-05 ²³⁸ U: 4.41e-04 to 5.53e-04
	Temperature	Room Temp.	Room Temp.	Room Temp.	Room Temp.	Room Temp.
Materials/ Moderator	Element	H	H	H	H	H
	Physical Form	Solution	Solution	Solution	Solution	Solution
	Atomic Density (atoms/b-cm)	5.56e-02 to 5.87e-02	5.87e-02 to 5.91e-02	5.87e-02	6.03e-02 to 6.13e-02	6.03e-02 to 6.13e-02
	Ratio to Fissile Material	469-729	731 to 751	721 to 728	971 to 1,239	971 to 1,239
	Temperature	Room Temp.	Room Temp.	Room Temp.	Room Temp.	Room Temp.
Materials/ Reflector	Material/ Physical Form	Unreflected	Reflected by concrete	Reflected by polyethylene	Reflected by water	Unreflected
Materials/ Neutron Absorber	Element	None	None	None	None	None
	Physical Form	N/A	N/A	N/A	N/A	N/A
	Atomic Density (atoms/b-cm)	N/A	N/A	N/A	N/A	N/A
Geometry	Heterogeneity	Homogeneous solution in a rectangular slab tank	Homogeneous solution in a rectangular slab tank	Homogeneous solution in a rectangular slab tank	Homogeneous solution in a cylindrical tank	Homogeneous solution in a cylindrical tank
	Shape	Rectangular slab	Rectangular slab	Rectangular slab	Cylinder	Cylinder
Neutron Energy	AENCF ^b	0.0192 to 0.0275 MeV	0.0183 to 0.0188 MeV	0.0189 to 0.0191 MeV	0.0125 to 0.0150 MeV	0.0127 to 0.0154 MeV
	EALF ^b	4.24e-02 to 5.23e-02 eV	Not available	Not available	Not available	Not available
	Neutron Energy Spectra ^a	T: 28.9 to 36.5% I: 28 to 31.1% F: 35.5 to 40.0%	Not available	Not available	Not available	Not available
	Fission Rate vs. Neutron Energy ^a	T: 94.3 to 96.0% I: 3.3 to 4.6% F: 0.7 to 1.0%	Not available	Not available	Not available	Not available

Source: BSC 2002 and NEA 2001, Spectra

NOTES: ^a Spectral range defined as follows: thermal (T) [0 to 1 eV], intermediate (I) [1eV to 100 keV], fast (F) [100 keV to 20 MeV].

^b AENCF = average energy of a neutron causing fission, EALF = energy of average lethargy causing fission.

VIII.5 CALCULATION OF THE LOWER-BOUND TOLERANCE LIMIT

The following results are excerpted from *Analysis of Critical Benchmark Experiments and Critical Limit Calculation for DOE SNF* (BSC 2003b) which present in detail the methodology and calculations performed for evaluating the LBTL for each set of configurations of the waste package containing Melt and Dilute ingots. The calculated k_{eff} values for the critical benchmarks are taken from *Analysis of Critical Benchmark Experiments and Critical Limit Calculation for DOE SNF* (BSC 2003b, Attachment II). The results of the trending parameter analysis for the critical benchmark subset representative for moderated degraded configurations of the waste package containing Melt and Dilute ingots are presented in Table VIII-6. The parameters in the following tables describe the regression statistics for the linear trend evaluations (see Attachment III for definitions). The P-value parameter gives a direct estimation of the probability of having a linear trending due to chance only.

Table VIII-6. Trending Parameter Results for the Critical Benchmark Subset Representative for Moderated Degraded (Homogeneous) Configurations of the Waste Packages Containing Melt and Dilute Ingots

Trend Parameter	n	Intercept	Slope	r ²	T	t _{0.025,n-2}	P-Value	Goodness-of-Fit Tests	Valid Trend
AENCF	103	1.0018	-0.0218	0.0369	-1.9659	1.960	0.0521	Failed	No
Enrichment (U ²³⁵ /U)	103	1.0048	-2.5E-04	0.1300	-3.8842	1.960	1.84E-04	Failed	No
H/U ²³⁵	103	0.9984	3.93E-06	0.0664	2.6792	1.960	0.0086	Failed	No

Source: BSC 2003b, p. 37

Figure VIII-2 presents the k_{eff} values and the calculated LBTL. The LBTL value calculated with the DFTL method for this subset (the normality test failed) is 0.9659 (BSC 2003b, Attachment I).

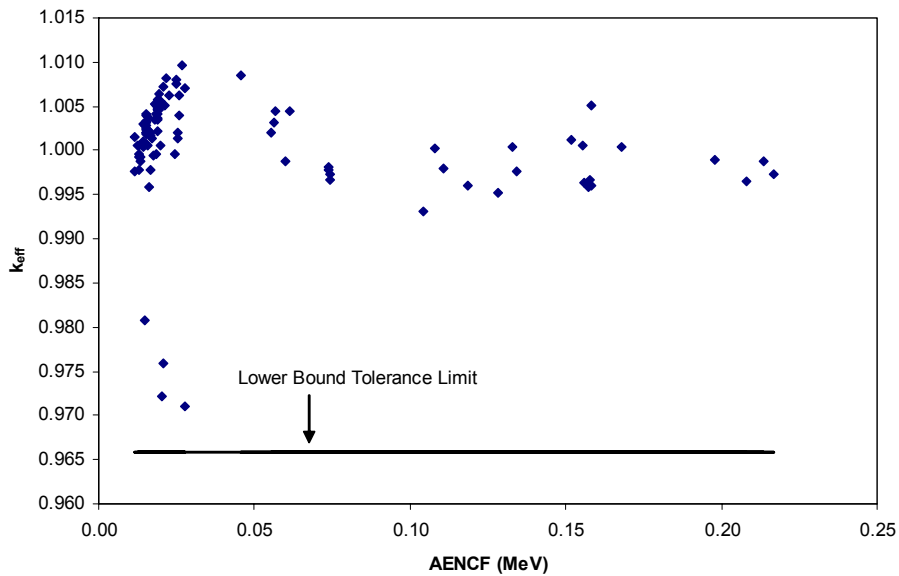

Figure VIII-2. Lower-Bound Tolerance Limit Applicable for Melt And Dilute Ingots Degraded (Homogeneous) Moderated Configurations

INTENTIONALLY LEFT BLANK

ATTACHMENT IX
LBTL CALCULATION AND ROA DETERMINATION FOR TRIGA SNF

ATTACHMENT IX

LBTL CALCULATION AND ROA DETERMINATION FOR TRIGA SNF

IX.1 INTRODUCTION

This attachment presents the calculations of the LBTL and the determination of ROA for benchmarks that could potentially be applicable to waste package configurations containing TRIGA SNF. A listing of corroborating and supporting data, models, or information used for the calculation is provided in Table IX-1.

Table IX-1. Supporting Information and Sources

Description	Source
Guidance for benchmarking a calculational method	Dean and Tayloe 2001
Criticality benchmark experiments, trending parameters, and CL calculations	BSC 2002; BSC 2003b; NEA 2001
TRIGA summary report	CRWMS M&O 2000b

NOTE: CL = critical limit, TRIGA = training, research, isotopes, general atomics.

The TRIGA SNF is representative of the uranium-zirconium hydride (UZrH) SNF group. This group is one of nine representative fuel groups designated by the National Spent Nuclear Fuel Program for disposal criticality analyses based on the fuel matrix composition, primary fissile isotope and enrichment (DOE 2002, Sections 5.2 and 5.3).

The following information regarding TRIGA SNF is collected from *Evaluation of Codisposal Viability for UZrH (TRIGA) DOE-Owned Fuel* (CRWMS M&O 2000b, Section 2.1.4). TRIGA reactors are a light-water-cooled, graphite- or water-reflected reactor designed for training, research, and isotope production. TRIGA reactors utilize solid fuel rods, in which the zirconium-hydride matrix is homogeneously combined with the enriched uranium and loaded into cylindrical rods 38.10 mm (1.5 in.) in diameter and 762.0 mm (30.0 in.) long. The inventory of TRIGA SNF falls into the following three basic categories: aluminum-clad fuel, stainless steel clad fuel, and fuel-follower control rods (fuel rod with neutron absorber axial section). Each of these basic fuel types has differences in uranium loading, enrichment, dimensions, and rod components. The TRIGA SNF considered in this report contains a uranium loading of 137g per rod, with 70 percent enrichment of ^{235}U , dispersed in the uranium-zirconium hydride matrix, which corresponds to the Fuel Life Improvement Program stainless steel clad rods. The H/Zr ratio is nominally 1.6.

The waste package configuration contains five HLW canisters surrounding a DOE-standardized (18-in. outer diameter) SNF canister. The outer diameters for the waste package and the 5-HLW glass canisters are 2120 mm and 610 mm, respectively. The isometric view of the TRIGA SNF canister is shown in Figure IX-1. The stainless steel canister will accommodate one, two, or three carbon steel baskets each loaded with 37 TRIGA fuel rods. For fuel rods with a maximum length of 774.7 mm, three baskets will be stacked in the SNF canister, so there will be a maximum of 111 rods per canister. For fuel rods with a maximum length of 1,143 mm, two baskets will be stacked in the SNF canister, so there will be 74 rods per canister. For fuel rods with a maximum length of 1,689.1 mm, one basket will be placed in the SNF canister so

there will be only 37 rods per canister. A 1-mm advanced neutron absorber tube matrix (Alloy 22 with 8 wt. % Gd) is placed inside of 12 structural tubes per basket *Evaluation of Codisposal Viability for UZrH (TRIGA) DOE-Owned Fuel* (CRWMS M&O 2000b, Section 2.1.3). The arrangement of the absorber tubes is shown in Figure IX-2. A cross section of an arrangement of TRIGA SNF rods in an 18-in. DOE SNF canister is shown in Figure IX-3. The rest of the waste package is not shown in order to enhance clarity of the constituents inside the DOE SNF canister.

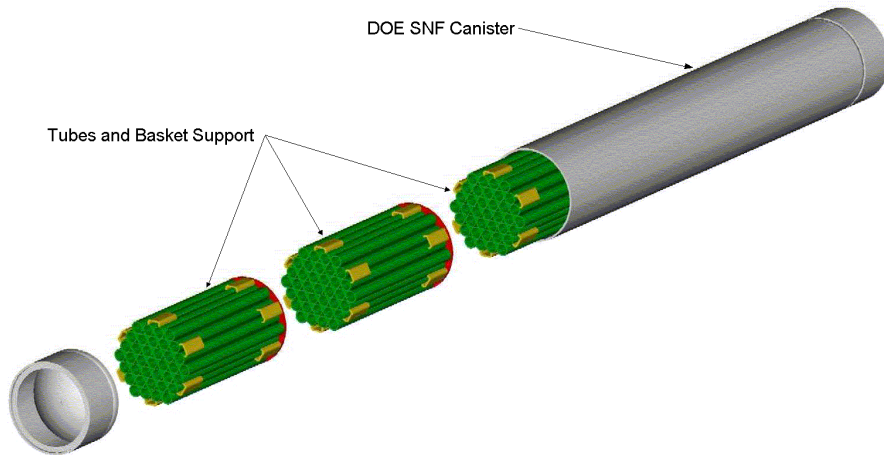

Figure IX-1. Isometric View of the TRIGA SNF Canister

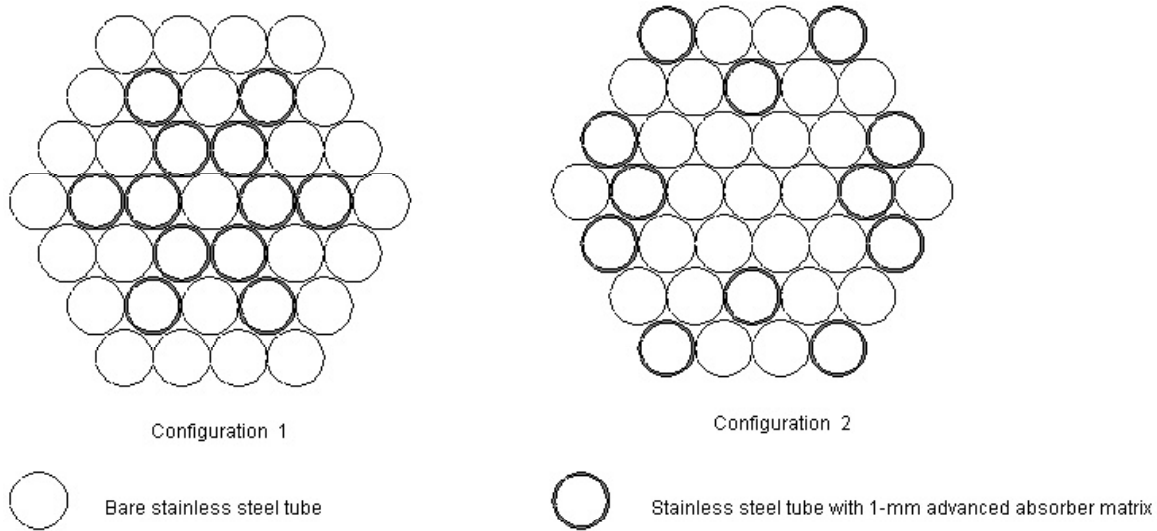
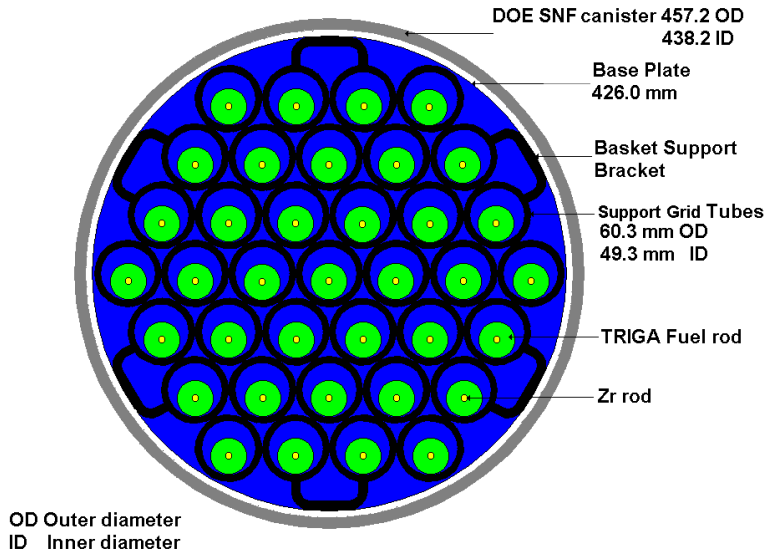

Figure IX-2. Emplacement of the Advanced Neutron Absorber Matrix



NOTE: DOE SNF = U.S. Department of Energy Spent Nuclear Fuel, TRIGA = training, research, isotopes, general atomics.

Figure IX-3. Cross Section of an Arrangement of TRIGA-SS Rods in an 18-inch DOE SNF Canister

IX.2 SELECTION OF THE CRITICALITY BENCHMARKS

The critical experiments selected for inclusion in benchmarking must be representative of the types of materials, conditions, and parameters to be represented using the calculational method. A sufficient number of experiments with varying experimental parameters should be selected for inclusion in the benchmarking to ensure as wide an area of applicability as feasible and statistically significant results. While there is no absolute guideline for the minimum number of critical experiments necessary to benchmark a computational method, the use of only a few (i.e., less than 10) experiments should be accompanied by a suitable technical basis supporting the rationale for acceptability of the results (Dean and Tayloe 2001, p. 5).

For the present application (codisposal of TRIGA SNF), the selected benchmark experiments have been grouped in 2 subsets (BSC 2002, Section 6.1.2) that include moderated heterogeneous and homogeneous experiments. The benchmark experiments are from *International Handbook of Evaluated Criticality Safety Benchmark Experiments* (NEA 2001), unless otherwise noted. The selection process was initially based on prior knowledge regarding the possible degraded configurations of the waste package (CRWMS M&O 2000b, Section 7), and the subsets have been constructed to accommodate large variations in the range of parameters of the configurations and to provide adequate statistics for LBTL calculations. The selected benchmark experiments for each subset are presented in *Benchmark and Critical Limit Calculation for DOE SNF* (BSC 2002, Tables 6-5 and 6-7) with MCNP cases constructed and calculation results. The cases, k_{eff} results, and their uncertainties are also summarized in *Analysis of Critical Benchmark Experiments and Critical Limit Calculation for DOE SNF* (BSC 2003b, Attachment II). Table IX-2 presents the list of the benchmark experiments and the number of cases for each subset selected for TRIGA SNF.

Table IX-2. Critical Benchmarks Selected for TRIGA SNF

Subset	Benchmark Experiment Identification ^a	No. of Cases Included
Heterogeneous Moderated ^b	HEU-COMP-THERM-002	25
	HEU-COMP-THERM-003	15
	HEU-COMP-THERM-004	4
	HEU-COMP-THERM-005	1
	HEU-COMP-THERM-006	3
	HEU-COMP-THERM-007	3
	HEU-COMP-THERM-008	2
	HEU-COMP-THERM-010	21
	HEU-COMP-THERM-011	3
	HEU-COMP-THERM-012	2
	HEU-COMP-THERM-013	2
	HEU-COMP-THERM-014	2
	HEU-MET-THERM-006	23
	IEU-COMP-THERM-003	2
Homogeneous Moderated ^b	HEU-SOL-THERM-001	10
	HEU-SOL-THERM-005	17
	HEU-SOL-THERM-006	29
	HEU-SOL-THERM-008	5
	HEU-SOL-THERM-009	4
	HEU-SOL-THERM-010	4
	HEU-SOL-THERM-011	2
	HEU-SOL-THERM-012	1
	HEU-SOL-THERM-013	4
	HEU-SOL-THERM-014	3
	HEU-SOL-THERM-015	5
	HEU-SOL-THERM-016	3
	HEU-SOL-THERM-017	8
	HEU-SOL-THERM-018	12
	HEU-SOL-THERM-019	3
	HEU-SOL-THERM-021	32
	HEU-SOL-THERM-025	18
	HEU-SOL-THERM-027	9
	HEU-SOL-THERM-028	18
	HEU-SOL-THERM-029	7
	HEU-SOL-THERM-030	7
	HEU-SOL-THERM-031	4
	HEU-SOL-THERM-032	1
	HEU-SOL-THERM-033	26
	HEU-SOL-THERM-035	9
	HEU-SOL-THERM-036	4
	HEU-SOL-THERM-037	9
	HEU-SOL-THERM-043	3
	HEU-SOL-THERM-044	16

Source: Subsets defined in BSC 2002

NOTES: ^aThe convention for naming the benchmark experiments is from NEA 2001.

^bIdentification of each subset from BSC 2002 has been changed to better reflect the subset's main characteristics. The benchmark experiments in each subset have not been affected.

The experiments cover configuration classes IP-2a, IP-3a, IP-3b, IP-3c, and IP-3d for the degraded waste package containing TRIGA SNF as described in Section 7.

IX.2.1 Range of Applicability of Selected Critical Benchmark Experiments

This section summarizes in a set of tables (Tables IX-3 to IX-12) the range of applicability of the experiments listed in Table IX-2. The information is partly excerpted from *Benchmark and Critical Limit Calculation for DOE SNF* (BSC 2002, Section 6.2), which presents a less comprehensive set of parameters. The tables have been enhanced by adding information regarding the spectral characteristics of the experiments (available for the majority of the benchmarks in *International Handbook of Evaluated Criticality Safety Benchmark Experiments* [NEA 2001]). The purpose is to construct a collective area of applicability that will be used to directly compare with the range of parameters of the codisposal configurations.

Table IX-3. Range of Applicability of Critical Benchmark Experiments Selected for Comparison with Heterogeneous Moderated Configurations of TRIGA SNF (Set 1)

Category/ Description	Parameter	Experiment HEU-COMP- THERM-002 (25 cases)	Experiment HEU-COMP- THERM-003 (15 cases)	Experiment HEU-COMP- THERM-004 (4 cases)	Experiment HEU-COMP- THERM-005 (1 case)
Materials/ Fissionable Material	Fissionable Element	Uranium	Uranium	Uranium	Uranium
	Physical Form	U-Dicarbide	UO ₂ + Cu	UO ₂ + Cu	UO ₂ + Cu
	Isotopic Composition	93.15 wt.% wt. % ²³⁵ U	79.66 wt. % ²³⁵ U	88.87 wt. % ²³⁵ U	79.66 wt. % ²³⁵ U
	Atomic Density (atoms/b-cm)	²³⁵ U: 9.98E-04 to 1.13e-03 ²³⁸ U: 7.24e-05 to 8.18e-05	²³⁵ U: 3.63e-03 ²³⁸ U: 8.72e-04	²³⁵ U: 5.13e-03 ²³⁸ U: 5.77e-04	²³⁵ U: 4.42e-03 ²³⁸ U: 1.06 e-03
	Temperature	Room Temp.	Room Temp.	Room Temp.	Room Temp.
Materials/ Moderator	Element	Hydrogen	H	Hydrogen	Hydrogen
	Physical Form	Water, Graphite	Water	Water	Water
	Atomic Density (atoms/b-cm)	H: 6.67e-2 C: 8.98e-2 to 9.80e-2 (in fuel)	6.67e-02	6.67e-02	6.67e-02
	Ratio to Fissile Material (In Region Containing Fissile Material)	C/X = 87 to 88.9	51 to 349	35	23
	Temperature	Room Temp.	Room Temp.	Room Temp.	Room Temp.
Materials/ Reflector	Material/ Physical Form	Reflected by water	Reflected by water and stainless steel	Reflected by water and stainless steel	Reflected by water and stainless steel
Materials/ Neutron Absorber	Element	None	None	Gd; Sm	None
	Physical Form	N/A	N/A	Gd ₂ O ₃ or Sm ₂ O ₃ Rods	N/A
	Atomic Density (atoms/b-cm)	N/A	N/A	Gd: 3.11e-04	N/A
Geometry	Heterogeneity	Various arrays of Al tuned or bare fuel elements (hexagonal graphite blocks containing uranium-dicarbide beads)	Cylindrical two zones hexagonally pitched lattice of cross-shaped fuel rods	Cylindrical hexagonally pitched double lattice of cross-shaped fuel rods and absorber rods	Hexagonally pitched array of fuel rod clusters (each containing a hexagonally pitched lattice of cross-shaped fuel rods)
	Shape	Cylinder	Cylinder	Cylinder	Cylinder

Table IX-3. Range of Applicability of Critical Benchmark Experiments Selected for Comparison with Heterogeneous Moderated Configurations of TRIGA SNF (Set 1)

Category/Description	Parameter	Experiment HEU-COMP-THERM-002 (25 cases)	Experiment HEU-COMP-THERM-003 (15 cases)	Experiment HEU-COMP-THERM-004 (4 cases)	Experiment HEU-COMP-THERM-005 (1 case)
Neutron Energy	AENCF ^b	0.0094 to 0.0244 MeV	0.0139 to 0.0467 MeV	0.0736 to 0.0756 MeV	0.0764 MeV
	EALF ^b	0.05 to 0.15 eV	0.06 to 0.40 eV	1.27 to 1.52 eV	1.46 eV
	Neutron Energy Spectra ^a	T: 15.2 to 49.4% I: 22.5 to 35.2% F: 28.1 to 50.6%	T: 9.9-37.7% I: 27.4 to 37% F: 36.9 to 53.1%	T: 3.6 to 4.1% I: 38.2 to 38.5% F: 57.4 to 58.1%	T: 6.5% I: 38.4% F: 55.1%
	Fission Rate vs. Neutron Energy ^a	T: 85.6 to 95.8% I: 3.6 to 12.8% F: 0.5 to 1.6%	T: 75.3 to 94.1% I: 5.2 to 21.9% F: 0.7 to 2.8%	T: 60.6 to 62.6% I: 32.9 to 34.7% F: 4.5 to 4.7%	T: 61.3% I: 33.8% F: 4.9%

Source: BSC 2002 and NEA 2001, Spectra

NOTES: ^a Spectral range defined as follows: thermal (T) [0 to 1 eV], intermediate (I) [1eV to 100 keV], fast (F) [100 keV to 20 MeV].

^b AENCF = average energy of a neutron causing fission, EALF = energy of average lethargy causing fission.

Table IX-4. Range of Applicability of Critical Benchmark Experiments Selected for Comparison with Heterogeneous Moderated Configurations of TRIGA SNF (Set 2)

Category/Description	Parameter	Experiment HEU-COMP-THERM-006 (3 cases)	Experiment HEU-COMP-THERM-007 (3 cases)	Experiment HEU-COMP-THERM-008 (2 cases)	Experiment HEU-COMP-THERM-010 (21 cases)
Materials/ Fissionable Material	Fissionable Element	Uranium	Uranium	Uranium	Uranium
	Physical Form	UO ₂ + Cu	UO ₂ + Cu	UO ₂ + Cu	UO ₂ + BeO
	Isotopic Composition	79.66 wt. % ²³⁵ U	79.66 wt. % ²³⁵ U	80 wt. % ²³⁵ U	62.4 wt.% wt. % ²³⁵ U
	Atomic Density (atoms/b-cm)	²³⁵ U: 4.42e-03 ²³⁸ U: 1.06 e-03	²³⁵ U: 3.63e-03 ²³⁸ U: 8.72e-04	²³⁵ U: 4.42e-03 ²³⁸ U: 1.06 e-03	²³⁵ U: 3.83E-03 ²³⁸ U: 2.24E-03 For solution: (cases 20-21) ²³⁵ U: 9.43E-06 ²³⁸ U: 7.44E-07
	Temperature	Room Temp.	Room Temp.	Room Temp.	Room Temp.
Materials/ Moderator	Element	Hydrogen	Hydrogen	Hydrogen	Hydrogen
	Physical Form	Water	Water; ZrH rods	Water	Water
	Atomic Density (atoms/b-cm)	6.67e-02	6.67e-02 (H ₂ O) 5.34e-02 (ZrH)	6.67e-02	6.67e-02 For solution: 6.65e-02 to 6.68e-02
	Ratio to Fissile Material (In Region Containing Fissile Material)	30 to 716	60 to 91	25	36 to 302
	Temperature	Room Temp.	Room Temp.	Room Temp.	Room Temp.
Materials/ Reflector	Material/ Physical Form	Reflected by water and stainless steel	Reflected by water and stainless steel	Reflected by water and stainless steel	Reflected by water

Table IX-4. Range of Applicability of Critical Benchmark Experiments Selected for Comparison with Heterogeneous Moderated Configurations of TRIGA SNF (Set 2) (Continued)

Category/ Description	Parameter	Experiment HEU-COMP- THERM-006 (3 cases)	Experiment HEU-COMP- THERM-007 (3 cases)	Experiment HEU-COMP- THERM-008 (2 cases)	Experiment HEU-COMP- THERM-010 (21 cases)
Materials/ Neutron Absorber	Element	None	None	Boron	B as Boric Acid (few cases)
	Physical Form	N/A	N/A	B ₄ C rods	In solution
	Atomic Density (atoms/b-cm)	N/A	N/A	B10: 1.12e-03 to 3.92e-03	B-10: 4.32E-07 to 3.49E-06 (cases 17 to 21)
Geometry	Heterogeneity	Cylindrical hexagonally pitched lattice of cross-shaped fuel rods	Cylindrical hexagonally pitched double lattice of cross-shaped fuel rods and ZrH rods	Cylindrical hexagonally double lattice of fuel rods and B ₄ C rod	Square or cylindrical assemblies with square or hexagonal pitched lattices
	Shape	Cylinder	Cylinder	Cylinder	Cylinder
Neutron Energy	AENCF^b	0.0104 to 0.0720 MeV	0.0339 to 0.0475 MeV	0.0882 to 0.0922 MeV	0.0230 to 0.0800 MeV
	EALF^b	0.05 to 1.12 eV	0.257 to 0.445 eV	2.5 to 2.9 eV	0.08 to 0.88 eV
	Neutron Energy Spectra^a	T: 4.9 to 47% I: 23.2 to 37.7% F: 29.8 to 57.4%	T: 8.0 to 11.9% I: 36.9 to 38.0% F: 51.2 to 54.0%	T: 2.5 to 3.0% I: 38.9 to 39.1% F: 57.9 to 58.6%	T: 6.1 to 28.2% I: 25.4 to 36.7% F: 46.4 to 57.2%
	Fission Rate vs. Neutron Energy^a	T: 64.1 to 96.1% I: 3.4 to 31.5% F: 0.5 to 4.4%	T: 73.8 to 80.9% I: 17.1 to 23.3% F: 2 to 2.9%	T: 53.6 to 55.2% I: 39.2 to 40.6% F: 5.6 to 5.8%	T: 67.7 to 92.5% I: 6.3 to 27.8% F: 1.2 to 4.5%

Source: BSC 2002 and NEA 2001, Spectra

NOTES: ^a Spectral range defined as follows: thermal (T) [0 to 1 eV], intermediate (I) [1eV to 100 keV], fast (F) [100 keV to 20 MeV].

^b AENCF = average energy of a neutron causing fission, EALF = energy of average lethargy causing fission.

Table IX-5. Range of Applicability of Critical Benchmark Experiments Selected for Comparison with Heterogeneous Moderated Configurations of TRIGA SNF (Set 3)

Category/ Description	Parameter	Experiment HEU-COMP- THERM-011 (3 cases)	Experiment HEU-COMP- THERM-012 (2 cases)	Experiment HEU-COMP- THERM-013 (2 cases)	Experiment HEU-COMP- THERM-014 (2 cases)
Materials/ Fissionable Material	Fissionable Element	Uranium	Uranium	Uranium	Uranium
	Physical Form	UO ₂ + Al alloy	UO ₂ + Al alloy	UO ₂ + Al alloy	UO ₂ + Al alloy
	Isotopic Composition	79.4 wt. % ²³⁵ U	79.4 wt. % ²³⁵ U	79.4 wt. % ²³⁵ U	79.4 wt. % ²³⁵ U
	Atomic Density (atoms/b-cm)	²³⁵ U: 2.66e-03 ²³⁸ U: 6.47e-03	²³⁵ U: 2.66e-03 ²³⁸ U: 6.47e-03	²³⁵ U: 2.66e-03 ²³⁸ U: 6.47e-03	²³⁵ U: 2.66e-03 ²³⁸ U: 6.47e-03
	Temperature	Room Temp.	Room Temp.	Room Temp.	Room Temp.
Materials/ Moderator	Element	Hydrogen	Hydrogen	Hydrogen	Hydrogen
	Physical Form	Water	Water	Water	Water
	Atomic Density (atoms/b-cm)	6.68e-02	6.68e-02	6.68e-02	6.68e-02
	Ratio to Fissile Material (In Region Containing Fissile Material)	170	35	40	170
	Temperature	Room Temp.	Room Temp.	Room Temp.	Room Temp.
Materials/ Reflector	Material/ Physical Form	Reflected by water	Reflected by water	Reflected by water	Reflected by water
Materials/ Neutron Absorber	Element	None	None	None	None
	Physical form	N/A	N/A	N/A	N/A
	Atomic Density (atoms/b-cm)	N/A	N/A	N/A	N/A
Geometry	Heterogeneity	Square clusters of cylindrical fuel rods arranged in square geometry	Square clusters of cylindrical fuel rods arranged in square geometry	Square clusters of cylindrical fuel rods arranged in square geometry	Square clusters of cylindrical fuel rods arranged in square geometry
	Shape	Cylinder	Cylinder	Cylinder	Cylinder
Neutron Energy	AENCF ^b	0.047 to 0.053 MeV	0.051 to 0.055 MeV	0.043 to 0.048 MeV	0.023 to 0.026 MeV
	EALF ^b	0.43 to 0.72 eV	0.43 to 0.56 eV	0.32 to 0.45 eV	0.10 to 0.12 eV
	Neutron Energy Spectra ^a	T: 6.6 to 10.0% I: 37.6 to 40.1% F: 52.4 to 53.5	T: 7.3 to 9.4% I: 37.1 to 38.4% F: 53.5 to 54.3%	T: 8.6 to 12.1% I: 36 to 37.9% F: 51.9 to 53.5%	T: 17.0 to 20.6% I: 31.4 to 33.1% F: 48.0 to 49.9%
	Fission Rate vs. Neutron Energy ^a	T: 68.4 to 74.2% I: 22.8 to 28.2% F: 3.0 to 3.4%	T: 71.8 to 74.7% I: 22.2 to 24.8% F: 3.1 to 3.4%	T: 73.7 to 77.6% I: 19.7 to 23.2% F: 2.7 to 3.1%	T: 87.9 to 89.8% I: 8.9 to 10.6% F: 1.3 to 1.5%

Source: BSC 2002 and NEA 2001, Spectra

NOTES: ^a Spectral range defined as follows: thermal (T) [0 to 1 eV], intermediate (I) [1eV to 100 keV], fast (F) [100 keV to 20 MeV].

^b AENCF = average energy of a neutron causing fission, EALF = energy of average lethargy causing fission.

Table IX-6. Range of Applicability of Critical Benchmark Experiments Selected for Comparison with Heterogeneous Moderated Configurations of TRIGA SNF (Set 4)

Category/ Description	Parameter	Experiment HEU-MET- THERM-006 (23 cases)	Experiment IEU-COMP- THERM-003 (2 cases)
Materials/ Fissionable Material	Fissionable Element	Uranium	Uranium
	Physical Form	U-Al alloy (fuel plates)	U-ZrH
	Isotopic Composition	93.17 wt. % ²³⁵ U	19.9 wt. % ²³⁵ U
	Atomic Density (atoms/b-cm)	²³⁵ U: 1.85E-03 ²³⁸ U: 1.13E-04 For U in solution (4 cases): ²³⁵ U: 1.02E-05 ²³⁸ U: 6.98E-07	²³⁵ U: 3.68e-04 ²³⁸ U: 1.46e-03
	Temperature	Room Temp.	Room Temp.
Materials/ Moderator	Element	Hydrogen	H
	Physical Form	Water	ZrH; Water
	Atomic Density (atoms/b-cm)	6.67e-02 For solution: 6.62e-02 to 6.64e-02	5.53e-02 (in ZrH) 6.69e-02 (H ₂ O)
	Ratio to Fissile Material (In Region Containing Fissile Material)	134 to 500	150.1
	Temperature	Room Temp.	Room Temp.
Materials/ Reflector	Material/Physical Form	Reflected by water or dilute aqueous uranyl nitrate solutions	Reflected radially by graphite and axially by water
Materials/ Neutron Absorber	Element	B or Cd (few cases)	B
	Physical Form	In solution	B ₄ C absorber rods
	Atomic Density (atoms/b-cm)	B-10: 4.27E-06 - 9.57E-06 (cases 19 to 23) Cd: 4.63e-02 (cases 17 and 18)	B10: 2.14e-02
Geometry	Heterogeneity	Rectangular arrays of fuel elements with various spacing	Complex cylindrical arrays of pins
	Shape	Slab (fuel plates)	Cylinder
Neutron Energy	AENCF ^b	0.010 to 0.015 MeV	0.0240 MeV
	EALF ^b	0.05 to 0.09 eV	N/A
	Neutron Energy Spectra ^a	T: 18.5 to 33.3% I: 25.3 to 36.5% F: 41.1 to 45%	N/A
	Fission Rate vs. Neutron Energy ^a	T: 89.9 to 95% I: 4.4 to 9.2% F: 0.5 to 0.9%	N/A

Source: BSC 2002 and NEA 2001, Spectra

NOTES: ^aSpectral range defined as follows: thermal (T) [0 to 1 eV], intermediate (I) [1eV to 100 keV], fast (F) [100 keV to 20 MeV].

^bAENCF = average energy of a neutron causing fission, EALF = energy of average lethargy causing fission.

Table IX-7. Range of Applicability of Critical Benchmark Experiments Selected for Comparison with Homogeneous Moderated Configurations of TRIGA SNF (Set 1)

Category/Description	Parameter	Experiment HEU-SOL-THERM-001 (10 cases)	Experiment HEU-SOL-THERM-005 (17 cases)	Experiment HEU-SOL-THERM-006 (29 cases)	Experiment HEU-SOL-THERM-008 (5 cases)	Experiment HEU-SOL-THERM-009 (4 cases)
Materials/ Fissionable Material	Fissionable Element	Uranium	Uranium	Uranium	Uranium	Uranium
	Physical Form	Aqueous solution of uranyl nitrate	Aqueous solution of uranyl nitrate	Aqueous solution of uranium oxyfluoride	Aqueous solution of uranyl nitrate	Aqueous solution of uranium oxyfluoride
	Isotopic Composition	93.17 wt. % ²³⁵ U	87.4 to 93.2 wt. % ²³⁵ U	93.06 wt. % ²³⁵ U	93.17 wt. % ²³⁵ U	93.18 wt. % ²³⁵ U
	Atomic Density (atoms/b-cm)	²³⁵ U: 1.31E-04 to 8.54E-04 ²³⁸ U: 7.46E-06 to 4.86E-05	²³⁵ U: 2.33-04 to 7.42E-04 ²³⁸ U: 3.32e-5 to 1.06E-03	²³⁵ U: 7.00e-04 to 7.1E-04 ²³⁸ U: 4.31e-5 to 4.37e-5	²³⁵ U: 1.44E-04 to 8.50E-04 ²³⁸ U: 8.20e-6 to 4.84E-05	²³⁵ U: 5.09E-04 to 1.66E-03 ²³⁸ U: 2.88e-5 to 9.41E-05
	Temperature	Room Temp.	Room Temp.	Room Temp.	Room Temp.	Room Temp.
Materials/ Moderator	Element	H	H	H	H	H
	Physical Form	Solution	Solution	Solution	Solution	Solution
	Atomic Density (atoms/b-cm)	5.82e-02 to 6.54e-02	5.95e-02 to 6.41e-02	5.91e-02 to 6.00e-02	5.84e-02 to 6.53e-02	5.964e-02 to 6.44e-02
	Ratio to Fissile Material	86 to 499	80 to 276	84 to 85	69 to 454	35.8 to 126.5
	Temperature	Room Temp.	Room Temp.	Room Temp.	Room Temp.	Room Temp.
Materials/ Reflector	Material/ Physical Form	Unreflected (concrete walls)	Unreflected or reflected (side and bottom) by water	Unreflected or reflected (side and bottom) by water, borated water. Nickel, water+nickel, borated water + nickel	Plexiglas	Water
Materials/ Neutron Absorber	Element	None	Boron	Boron	None	None
	Physical Form	N/A	Boron in Pyrex glass	Enriched Boron in Boric Acid	N/A	N/A
	Atomic Density (atoms/b-cm)	N/A	B10: 9.82e-4	B10: 2.49e-5 – 8.03e-5	N/A	N/A
Geometry	Heterogeneity	Homogeneous solution contained in a cylindrical tank	Homogeneous solution contained in a cylindrical stainless steel tank	Homogeneous solution contained in a spherical stainless steel vessel	Arrays of cylindrical tanks placed in a rectangular geometry	Homogeneous solution contained in a spherical Al vessel
	Shape	Cylinder	Cylinder	Cylinder	Cylinder	Sphere
Neutron Energy	AENCF ^b	0.0065 to 0.0410 MeV	0.0110 to 0.0410 MeV	0.0320 to 0.0430 MeV	0.0064 to 0.0367 MeV	0.0180 to 0.0450 MeV
	EALF ^b	0.04 to 0.29 eV	0.06 to 0.33 eV	0.20 to 0.44 eV	0.04 to 0.25 eV	0.09 to 0.52 eV
	Neutron Energy Spectra ^a	T: 8.1 to 31.1% I: 29.1 to 36.5% F: 39.8 to 55.6%	T: 5.6 to 21.7% I: 32.5 to 39.2% F: 45.8 to 55.5%	T: 7.4 to 9.7% I: 35.9 to 39.5% F: 53 to 54.5%	T: 8.5 to 30.8% I: 29.1 to 36.3% F: 40.0 to 55.5%	T: 5.8 to 15.4% I: 34 to 35.7% F: 50.6 to 58.5%
	Fission Rate vs. Neutron Energy ^a	T: 77.5 to 95.5% I: 4.1 to 20.3% F: 0.4 to 2.2%	T: 75.4 to 92.8% I: 6.6 to 22.3% F: 0.6 to 2.3%	T: 72.5 to 81.4% I: 16.8 to 25.2% F: 1.8 to 2.4%	T: 78.9 to 95.5% I: 4.1 to 19.0% F: 0.4 to 2.1%	T: 71.8 to 89.1% I: 9.9 to 25.0% F: 1.0 to 3.2%

Source: BSC 2002, and NEA 2001, Spectra

NOTES: ^a Spectral range defined as follows: thermal (T) [0 to 1 eV], intermediate (I) [1eV to 100 keV], fast (F) [100 keV to 20 MeV].

^b AENCF = average energy of a neutron causing fission, EALF = energy of average lethargy causing fission.

Table IX-8. Range of Applicability of Critical Benchmark Experiments Selected for Comparison with Homogeneous Moderated Configurations of TRIGA SNF (Set 2)

Category/ Description	Parameter	Experiment HEU-SOL- THERM-010 (4 cases)	Experiment HEU-SOL- THERM-011 (2 cases)	Experiment HEU-SOL- THERM-012 (1case)	Experiment HEU-SOL- THERM-013 (4 cases)	Experiment HEU-SOL- THERM-014 (3 cases)
Materials/ Fissionable Material	Fissionable Element	Uranium	Uranium	Uranium	Uranium	Uranium
	Physical Form	Aqueous solution of uranium oxyfluoride	Aqueous solution of uranium oxyfluoride	Aqueous solution of uranium oxyfluoride	Aqueous solution of uranyl nitrate	Aqueous solution of uranyl nitrate
	Isotopic Composition	93.12 wt. % ²³⁵ U	93.12 wt. % ²³⁵ U	93.2 wt. % ²³⁵ U	93.2 wt. % ²³⁵ U	89 wt. % ²³⁵ U
	Atomic Density (atoms/b-cm)	²³⁵ U: 2.44E-04 to 2.66E-04 ²³⁸ U: 1.36e-5 to 1.49E-05	²³⁵ U: 1.24E-04 to 1.27E-04 ²³⁸ U: 7.04e-6 to 7.16E-06	²³⁵ U: 5.24e-4 ²³⁸ U: 2.97e-6	²³⁵ U: 4.80E-05 to 6.79E-05 ²³⁸ U: 2.80e-6 to 3.97E-06	²³⁵ U: 1.54E-04 to 1.60E-04 ²³⁸ U: 1.68e-5 to 1.74E-0
	Temperature	300.5 to 358.5 K	Room Temp.	Room Temp.	Room Temp.	Room Temp.
Materials/ Moderator	Element	H	H	H	H	H
	Physical Form	Solution	Solution	Solution	Solution	Solution
	Atomic Density (atoms/b-cm)	6.36e-02 to 6.57e-02	6.62e-02 to 6.63e-02	6.67e-02	6.58e-02 to 6.60e-02	6.47e-02 to 6.50e-02
	Ratio to Fissile Material	239 to 270	523 to 533	1272	971 to 1375	405 to 421
	Temperature	300.5 to 358.5 K	Room Temp.	Room Temp.	Room Temp.	Room Temp.
Materials/ Reflector	Material/ Physical Form	Water	Water	Water	Unreflected	Water
Materials/ Neutron Absorber	Element	None	None	None	Boron (3 cases)	Gd (2 cases)
	Physical Form	N/A	N/A	N/A	In solution (boric acid)	In solution
	Atomic Density (atoms/b-cm)	N/A	N/A	N/A	B10: 1.04e-6 to 2.55e-06	3.83e-07 to 7.39e-07
Geometry	Heterogeneity	Homogeneous solution contained in a spherical Al vessel	Homogeneous solution contained in a spherical Al vessel	Homogeneous solution contained in a spherical Al vessel	Homogeneous solution contained in a spherical Al vessel	Homogeneous solution contained in a cylindrical stainless steel vessel
	Shape	Sphere	Sphere	Sphere	Sphere	Cylinder
Neutron Energy	AENCF	0.0090 to 0.010 MeV	0.0050 MeV	0.0027 MeV	0.0026 to 0.0038 MeV	0.0071 to 0.0076 MeV
	EALF	0.05 to 0.06 eV	0.04 eV	0.03 eV	0.033 to 0.036 eV	0.046 to 0.050 eV
	Neutron Energy Spectra ^a	T: 23 to 24.7% I: 31.1 to 31.6% F: 44.2 to 45.4%	T: 34.9 to 35.2% I: 27.5 to 27.6% F: 37.3 to 37.5%	T: 49.5% I: 22.2% F: 28.3%	T: 41.4 to 49.5% I: 22.3 to 25.8% F: 28.2 to 32.8%	T: 27.7 to 28.9% I: 30.1 to 31.4% F: 40.9 to 41%
	Fission Rate vs. Neutron Energy ^a	T: 93.3 to 94.0% I: 5.5 to 6.1% F: 0.5 to 0.6%	T: 96.3% I: 3.4% F: 0.3%	T: 97.9% I: 1.9% F: 0.2%	T: 97.1 to 97.9% I: 1.9 to 2.7% F: 0.2%	T: 94.4 to 95.0% I: 4.6 to 5.2% F: 0.4%

Source: BSC 2002 and NEA 2001, Spectra

NOTE: ^a Spectral range defined as follows: thermal (T) [0 to 1 eV], intermediate (I) [1eV to 100 keV], fast (F) [100 keV to 20 MeV].

Table IX-9. Range of Applicability of Critical Benchmark Experiments Selected for Comparison with Homogeneous Moderated Configurations of TRIGA SNF (Set 3)

Category/ Description	Parameter	Experiment HEU-SOL- THERM-015 (5 cases)	Experiment HEU-SOL- THERM-016 (3 cases)	Experiment HEU-SOL- THERM-017 (8 cases)	Experiment HEU-SOL- THERM-018 (12 cases)	Experiment HEU-SOL- THERM-019 (3 cases)
Materials/ Fissionable Material	Fissionable Element	Uranium	Uranium	Uranium	Uranium	Uranium
	Physical Form	Aqueous solution of uranyl nitrate	Aqueous solution of uranyl nitrate	Aqueous solution of uranyl nitrate	Aqueous solution of uranyl nitrate	Aqueous solution of uranyl nitrate
	Isotopic Composition	89 wt. % ²³⁵ U	89 wt. % ²³⁵ U	89 wt. % ²³⁵ U	89 wt. % ²³⁵ U	89 wt. % ²³⁵ U
	Atomic Density (atoms/b-cm)	²³⁵ U: 2.17E-04 to 2.29E-04 ²³⁸ U: 2.37e-5 to 2.50E-05	²³⁵ U: 3.29E-04 to 3.57E-04 ²³⁸ U: 3.59e-5 to 3.89E-05	²³⁵ U: 4.25E-04 to 4.62E-04 ²³⁸ U: 4.63e-5 to 5.03E-05	²³⁵ U: 6.38E-04 to 6.84E-04 ²³⁸ U: 6.95e-5 to 7.46E-05	²³⁵ U: 8.98E-04 to 1.02E-03 ²³⁸ U: 9.79e-5 to 1.11E-04
	Temperature	Room Temp.	Room Temp.	Room Temp.	Room Temp.	Room Temp.
Materials/ Moderator	Element	H	H	H	H	H
	Physical Form	Solution	Solution	Solution	Solution	Solution
	Atomic Density (atoms/b-cm)	6.38e-02 to 6.40e-02	6.26e-02 to 6.30e-02	6.13e-02 to 6.23e-02	5.89e-02 to 5.97e-02	5.58e-02 to 5.66e-02
	Ratio to Fissile Material	278 to 295	175 to 192	133 to 147	86 to 94	55 to 63
	Temperature	Room Temp.	Room Temp.	Room Temp.	Room Temp.	Room Temp.
Materials/ Reflector	Material/ Physical Form	Water	Water	Water	Water	Water
Materials/ Neutron Absorber	Element	Gd (3 cases)	Gd (2 cases)	Gd (5 cases)	Gd (9 cases)	Gd (2 cases)
	Physical Form	In solution	In solution	In solution	In solution	In solution
	Atomic Density (atoms/b-cm)	7.54e-07 to 1.53e-06	1.15e-06 to 2.01e-06	1.14e-06 to 3.03e-06	1.90e-06 to 7.44e-06	2.48e-06 to 4.44e-06
Geometry	Heterogeneity	Homogeneous solution contained in a cylindrical vessel made of stainless steel	Homogeneous solution contained in a cylindrical vessel made of stainless steel	Homogeneous solution contained in a cylindrical vessel made of stainless steel	Homogeneous solution contained in a cylindrical vessel made of stainless steel	Homogeneous solution contained in a cylindrical vessel made of stainless steel
	Shape	Cylinder	Cylinder	Cylinder	Cylinder	Cylinder
Neutron Energy	AENCF ^b	0.0100 to 0.0113 MeV	0.0151 to 0.0161 MeV	0.0189 to 0.0221 MeV	0.0285 to 0.0329 MeV	0.0393 to 0.0425 MeV
	EALF ^b	0.056 to 0.066 eV	0.078 to 0.092 eV	0.097 to 0.135 eV	0.16 to 0.27 eV	0.29 to 0.35 eV
	Neutron Energy Spectra ^a	T: 21.7 to 23.3% I: 31.9 to 34.0% F: 44.3 to 45.1%	T: 16.9 to 17.6% I: 33.9 to 35.6% F: 47.5 to 48.7%	T: 13.3 to 14.9% I: 34.6 to 36.9% F: 49.5 to 51.1%	T: 9.5 to 11.0% I: 35.6 to 38.3% F: 51.9 to 53.9%	T: 7.7 to 8.4% I: 36.4 to 37.3% F: 54.7 to 55.9%
	Fission Rate vs. Neutron Energy ^a	T: 92.1 to 93.4% I: 6.1 to 7.3% F: 0.6%	T: 89.0 to 90.4% I: 8.8 to 10.1% F: 0.8 to 0.9%	T: 85.3 to 88.4% I: 10.6 to 13.5% F: 1.0 to 1.2%	T: 78.3 to 83.6% I: 14.8 to 19.8% F: 1.6 to 1.9%	T: 75.9 to 77.6% I: 20.2 to 21.8% F: 2.2 to 2.4%

Source: BSC 2002 and NEA 2001, Spectra

NOTES: ^a Spectral range defined as follows: thermal (T) [0 to 1 eV], intermediate (I) [1eV to 100 keV], fast (F) [100 keV to 20 MeV].

^b AENCF = average energy of a neutron causing fission, EALF = energy of average lethargy causing fission.

Table IX-10. Range of Applicability of Critical Benchmark Experiments Selected for Comparison with Homogeneous Moderated Configurations of TRIGA SNF (Set 4)

Category/ Description	Parameter	Experiment HEU-SOL- THERM-021 (32 cases)	Experiment HEU-SOL- THERM-025 (18 cases)	Experiment HEU-SOL- THERM-027 (9 cases)	Experiment HEU-SOL- THERM-028 (18 cases)	Experiment HEU-SOL- THERM-029 (7 cases)
Materials/ Fissionable Material	Fissionable Element	Uranium	Uranium	Uranium	Uranium	Uranium
	Physical Form	Aqueous solution of uranyl nitrate	Aqueous solution of uranyl nitrate	Aqueous solution of uranyl nitrate	Aqueous solution of uranyl nitrate	Aqueous solution of uranyl nitrate
	Isotopic Composition	92.6 wt. % ²³⁵ U	89 wt. % ²³⁵ U	89 wt. % ²³⁵ U	89 wt. % ²³⁵ U	89 wt. % ²³⁵ U
	Atomic Density (atoms/b-cm)	²³⁵ U: 1.50E-04 to 9.85E-04 ²³⁸ U: 9.45e-6 to 6.19E-05	²³⁵ U: 1.15E-04 to 1.76E-04 ²³⁸ U: 1.27e-5 to 1.92E-05	²³⁵ U: 3.10e-04 ²³⁸ U: 3.38e-05	²³⁵ U: 1.73e-4 to 6.52e-4 ²³⁸ U: 1.89e-5- 7.1e-05	²³⁵ U: 6.53e-04 ²³⁸ U: 7.10e-05
	Temperature	Room Temp.	Room Temp.	Room Temp.	Room Temp.	Room Temp.
Materials/ Moderator	Element	H	H	H	H	H
	Physical Form	Solution	Solution	Solution	Solution	Solution
	Atomic Density (atoms/b-cm)	5.79e-02 to 6.53e-02	6.48e-02 to 6.50e-02	6.32e-02	5.97e-02 to 6.50e-2	5.97e-02
	Ratio to Fissile Material	59 to 435	61.8 to 556	203.6	91.5 to 374.5	91.5
	Temperature	Room Temp.	Room Temp.	Room Temp.	Room Temp.	Room Temp.
Materials/ Reflector	Material/ Physical Form	Water, Plexiglas, paraffin	Water	Unreflected	Water	Water
Materials/ Neutron Absorber	Element	None	Gd (1 case)	B or Cd	B (9 cases)	B (6 cases)
	Physical Form	N/A	In solution	Absorber rods	B ₄ C rods	B ₄ C rods
	Atomic Density (atoms/b-cm)	N/A	4.09e-7	B10: 1.08e-2 Cd: 4.63e-2	B-10: 1.08e-2	B-10: 1.08e-2
Geometry	Heterogeneity	Arrays of cylindrical containers placed in a rectangular geometry	Homogeneous solution contained in a cylindrical stainless steel vessel	Homogeneous solution contained in a cylindrical stainless steel vessel	Homogeneous solution contained in a cylindrical stainless steel vessel	Homogeneous solution contained in a cylindrical stainless steel vessel
	Shape	Cylinder	Cylinder	Cylinder	Cylinder	Cylinder
Neutron Energy	AENCF ^b	0.0067 to 0.0437 MeV	0.0050 to 0.0280 MeV	0.014 to 0.015 MeV	0.007 to 0.027	0.027 to 0.029
	EALF ^b	0.04 to 0.33 eV	0.041 to 0.18 eV	0.074 to 0.076 eV	0.047 to 0.153 eV	0.156 to 0.167 eV
	Neutron Energy Spectra ^a	T: 7.6 to 30. % I: 29.5 to 36.5% F: 40.3 to 56%	T: 16.5 to 34.2% I: 28.2 to 35.6% F: 37.6 to 47.9%	T: 8.4 to 25.0% I: 29.9 to 39.3% F: 40.8 to 61.0%	T: 5.8 to 28.1% I: 30.4 to 35.7% F: 41.5 to 61.7%	T: 8.2 to 11.1% I: 34.4 to 35.8% F: 53.1 to 57.4%
	Fission Rate vs. Neutron Energy ^a	T: 76.4 to 95.4% I: 4.2 to 21.2% F: 0.4 to 2.4%	T: 81.5 to 96.1% I: 3.6 to 16.9% F: 0.3 to 1.6%	T: 90.5 to 90.8% I: 8.4 to 8.6% F: 0.8 to 0.9%	T: 84.0 to 94.9% I: 4.7 to 14.5% F: 0.4 to 1.5%	T: 82.9 to 83.8% I: 14.7 to 15.5% F: 1.5 to 1.6%

Source: BSC 2002 and NEA 2001, Spectra

NOTES: ^a Spectral range defined as follows: thermal (T) [0 to 1 eV], intermediate (I) [1eV to 100 keV], fast (F) [100 keV to 20 MeV].

^b AENCF = average energy of a neutron causing fission, EALF = energy of average lethargy causing fission.

Table IX-11. Range of Applicability of Critical Benchmark Experiments Selected for Comparison with Homogeneous Moderated Configurations of TRIGA SNF (Set 5)

Category/ Description	Parameter	Experiment HEU-SOL- THERM-030 (7 cases)	Experiment HEU-SOL- THERM-031 (4 cases)	Experiment HEU-SOL- THERM-032 (1 case)	Experiment HEU-SOL- THERM-033 (26 cases)	Experiment HEU-SOL- THERM-035 (9 cases)
Materials/ Fissionable Material	Fissionable Element	Uranium	Uranium	Uranium	Uranium	Uranium
	Physical Form	Aqueous solution of uranyl nitrate	Aqueous solution of uranyl nitrate	Aqueous solution of uranyl nitrate	Aqueous solution of uranyl nitrate	Aqueous solution of uranyl nitrate
	Isotopic Composition	89 wt. % ²³⁵ U	89 wt. % ²³⁵ U	93.2 wt. % ²³⁵ U	93.2 wt. % ²³⁵ U	89 wt. % ²³⁵ U
	Atomic Density (atoms/b-cm)	²³⁵ U: 1.73e-04 to 6.60e-4 ²³⁸ U: 1.89e-05 to 7.17e-5	²³⁵ U: 6.60e-4 ²³⁸ U: 7.17e-5	²³⁵ U: 3.62e-5 ²³⁸ U: 1.99e-6	²³⁵ U: 8.54e-4 ²³⁸ U: 4.85e-5	²³⁵ U: 8.56e-5 to 3.74e-4 ²³⁸ U: 9.31e-06 to 3.78e-5
	Temperature	Room Temp.	Room Temp.	Room Temp.	Room Temp.	Room Temp.
Materials/ Moderator	Element	H	H	H	H	H
	Physical Form	Solution	Solution	Solution	Solution	Solution
	Atomic Density (atoms/b-cm)	6.01e-02 to 6.50e-02	6.01e-2	6.64e-2	5.81e-02	6.28e-2 to 6.56e-02
	Ratio to Fissile Material	91.1 to 374.6	91.1	1835	68.1	181 to 767
	Temperature	Room Temp.	Room Temp.	Room Temp.	Room Temp.	Room Temp.
Materials/ Reflector	Material/ Physical Form	Water	Water	unreflected	concrete	water
Materials/ Neutron Absorber	Element	B (5 cases)	B (9 cases)	None	B and Cd	B
	Physical Form	B ₄ C rods	B ₄ C rods	N/A	B and Cd in solution	B ₄ C rods
	Atomic Density (atoms/b-cm)	B-10: 1.08e-2	B-10: 9.54e-3	N/A	B-10: 1.74e-8 Cd: 1.49e-8	B-10: 1.08e-2
Geometry	Heterogeneity	Homogeneous solution contained in a cylindrical stainless steel vessel made	Homogeneous solution contained in a cylindrical stainless steel vessel	Homogeneous solution contained in a spherical Al vessel	Homogeneous solution contained in a nested structure of cylindrical stainless steel tanks	Homogeneous solution contained in a cylindrical stainless steel tank
	Shape	Cylinder	Cylinder	Sphere	Cylinder	Cylinder
Neutron Energy	AENCF	0.008 to 0.028	0.028 to 0.031	0.0021	0.032 to 0.036	0.004 to 0.016
	EALF	0.048 to 0.164 eV	0.163 to 0.187 eV	0.031 eV	0.269 to 0.316 eV	0.038 to 0.084 eV
	Neutron Energy Spectra ^a	T: 8.5 to 27.7% I: 30.5 to 35.8% F: 41.7 to 56.6%	T: 7.6 to 8.9% I: 35.5 to 35.9% F: 55.7 to 56.6%	T: 54.6% I: 20.3% F: 25.1%	T: 8.1 to 8.8% I: 38.2 to 39% F: 52.6 to 53.4%	T: 14.7 to 38.7% I: 26.7 to 34.3% F: 34.6 to 51.2%
	Fission Rate vs. Neutron Energy ^a	T: 83.2 to 94.7% I: 4.8 to 15.2% F: 0.4 to 1.6%	T: 81.7 to 83.3% I: 15.1 to 16.6% F: 1.6 to 1.7%	T: 98.3% I: 1.6% F: 0.1%	T: 76.2 to 78.0% I: 20.1 to 21.7% F: 1.9 to 2.1%	T: 89.6 to 96.8% I: 3.0 to 9.5% F: 0.2 to 0.9%

Source: BSC 2002 and NEA 2001, Spectra

NOTE: ^a Spectral range defined as follows: thermal (T) [0 to 1 eV], intermediate (I) [1eV to 100 keV], fast (F) [100 keV to 20 MeV].

Table IX-12. Range of Applicability of Critical Benchmark Experiments Selected for Comparison with Homogeneous Moderated Configurations of TRIGA SNF (Set 6)

Category/Description	Parameter	Experiment HEU-SOL-THERM-036 (4 cases)	Experiment HEU-SOL-THERM-037 (9 cases)	Experiment HEU-SOL-THERM-043 (3 case)	Experiment HEU-SOL-THERM-044 (16 cases)
Materials/ Fissionable Material	Fissionable Element	Uranium	Uranium	Uranium	Uranium
	Physical Form	Aqueous solution of uranyl nitrate	Aqueous solution of uranyl nitrate	Aqueous solution of uranium oxyfluoride	Aqueous solution of uranyl nitrate
	Isotopic Composition	89 wt. % ²³⁵ U	89 wt. % ²³⁵ U	93.2 wt. % ²³⁵ U	93.17 wt. % ²³⁵ U
	Atomic Density (atoms/b-cm)	²³⁵ U: 2.12e-4 ²³⁸ U: 2.29e-5	²³⁵ U: 9.56e-5 to 1.89e-4 ²³⁸ U: 1.04e-5 to 2.06e-5	²³⁵ U: 4.77e-05 to 3.20e-04 ²³⁸ U: 2.86e-06 to 1.79e-05	²³⁵ U: 8.65e-4 ²³⁸ U: 4.95e-5
	Temperature	Room Temp.	Room Temp.	Room Temp.	Room Temp.
Materials/ Moderator	Element	H	H	H	H
	Physical Form	Solution	Solution	Solution	Solution
	Atomic Density (atoms/b-cm)	6.40e-2	6.43e-02 to 6.55e-02	6.53e-2 to 6.67e-2	5.81e-02
	Ratio to Fissile Material	302.5	340 to 685	204 to 1392	67.2
	Temperature	Room Temp.	Room Temp.	Room Temp.	Room Temp.
Materials/ Reflector	Material/ Physical Form	Unreflected	Water	Unreflected	Concrete
Materials/ Neutron Absorber	Element	B (3 cases)	B (6 cases)	None	B, Cl, Cd, and Gd
	Physical Form	B ₄ C rods	B ₄ C rods	N/A	Absorbers are in various forms (pyrex glass, boraflex rubber, Cd sleeves, etc.)
	Atomic Density (atoms/b-cm)	B-10: 1.08e-2	B-10: 1.08e-2	N/A	B-10: 6.99e-03 to 9.57e-4 Cd: 5.19e-03 to 4.63e-02
Geometry	Heterogeneity	Homogeneous solution contained in a square stainless steel and Cd (inner wall) tank	Homogeneous solution contained in a cylindrical stainless steel vessel	Homogeneous solution contained in a spherical Al vessel	Homogeneous solution contained in a nested structure of cylindrical stainless steel tanks
	Shape	Parallel-piped	Cylinder	Sphere	Cylinder
Neutron Energy	AENCF	0.010 to 0.012	0.005 to 0.009	0.003 to 0.014	0.0340 to 0.0470
	EALF	0.056 to 0.063 eV	0.038 to 0.054 eV	0.033 to 0.075 eV	N/A
	Neutron Energy Spectra^a	T: 12.5 to 23.1% I: 31.9 to 32.9% F: 44.9 to 54.6%	T: 21.1 to 37.1% I: 27.1 to 32.4% F: 35.8 to 46.5%	T: 18.0 to 49.8% I: 22.2 to 33.7% F: 28.0 to 48.3%	N/A
	Fission Rate vs. Neutron Energy^a	T: 92.0 to 93.3% I: 6.1 to 7.3% F: 0.6 to 0.7%	T: 93.5 to 96.6% I: 3.2 to 6.0% F: 0.2 to 0.5%	T: 90.8 to 97.9% I: 1.9 to 8.4% F: 0.1 to 0.8%	N/A

Source: BSC 2002 and NEA 2001, Spectra

NOTES: ^a Spectral range defined as follows: thermal (T) [0 to 1 eV], intermediate (I) [1eV to 100 keV], fast (F) 100 keV to 20 MeV].

^b AENCF = average energy of a neutron causing fission, EALF = energy of average lethargy causing fission.

IX.3 CALCULATION OF THE LOWER-BOUND TOLERANCE LIMIT

The following results are excerpted from *Analysis of Critical Benchmark Experiments and Critical Limit Calculation for DOE SNF* (BSC 2003b), which present in detail the methodology and calculations performed for evaluating the LBTL for each set of configurations of the waste package containing TRIGA SNF. The calculated k_{eff} values for the critical benchmarks are taken from *Analysis of Critical Benchmark Experiments and Critical Limit Calculation for DOE SNF* (BSC 2003b, Attachment II). The results of the trending parameter analysis for the critical benchmark subset representative for moderated intact (heterogeneous) configurations (configuration classes IP-3a, IP-3b, IP-3c, and IP-3d) of the waste package containing TRIGA SNF are presented in Table IX-13. The parameters in the following tables describe the regression statistics for the linear trend evaluations (see Attachment III for definitions). The P-value parameter gives a direct estimation of the probability of having a linear trending due to chance only.

Table IX-13. Trending Parameter Results for the Critical Benchmark Subset Representative for Moderated Intact Fuel Configurations of the Waste Package Containing TRIGA SNF

Trend Parameter	n	Intercept	Slope	r ²	T	t _{0.025,n-2}	P-Value	Goodness-of-Fit Tests	Valid Trend
AENCF	108	1.0120	-0.3315	0.4566	-9.4373	1.960	1.04E-15	Passed	Yes
H/ ²³⁵ U	81	0.9945	2.56E-05	0.1321	3.4679	1.960	8.52E-04	Passed	Yes

Source: BSC 2003b, p. 30

NOTE: ^aAENCF = average energy of a neutron causing fission.

Figure IX-4 presents the k_{eff} values and the calculated lower-bound tolerance limit. Details for the calculation of the LBTL function are provided in *Analysis of Critical Benchmark Experiments and Critical Limit Calculation for DOE SNF* (BSC 2003b, Attachment I) with the results as follows:

Lower-bound tolerance limit = 0.9668 for 0 MeV < AENCF < 0.0404 MeV

Lower-bound tolerance limit = -0.3315 × AENCF + 0.9788 for 0.0404 MeV < AENCF < 0.0922 MeV

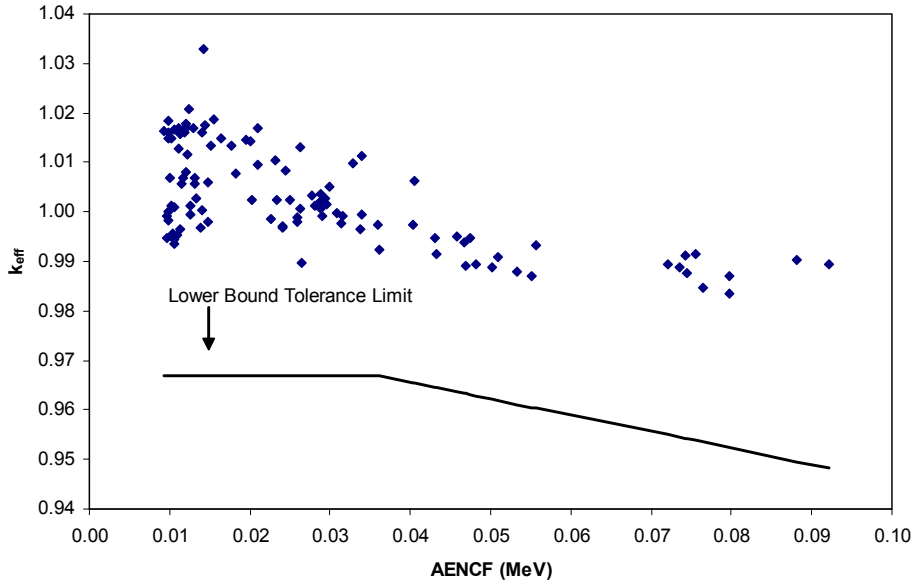

Figure IX-4. Lower-Bound Tolerance Limit Applicable for TRIGA SNF Intact Moderated (Heterogeneous) Configurations

The results of the trending parameter analysis for the critical benchmark subset representative for moderated degraded configurations (homogeneous) (configuration class IP-2a) of the waste package containing TRIGA SNF are presented in Table IX-14.

Table IX-14. Trending Parameter Results for the Critical Benchmark Subset Representative for Moderated Degraded Configurations of the Waste Package Containing TRIGA SNF

Trend Parameter	n	Intercept	Slope	r ²	T	t _{0.025,n-2}	P-Value	Goodness-of-Fit Tests	Valid Trend
AENCF	273	1.0046	-0.0055	9.10E-05	-0.1571	1.960	0.8753	Failed	No
H/X	273	1.0045	-1.82E-07	3.31E-05	-0.0947	1.960	0.9246	Failed	No

Source: BSC 2003b, p. 32

NOTE: ^a AENCF=average energy of a neutron causing fission.

Figure IX-5 presents the k_{eff} values and the calculated LBTL. The LBTL value calculated with DFTL method for this subset (normality test failed) is 0.9796 (BSC 2003b, Attachment I).

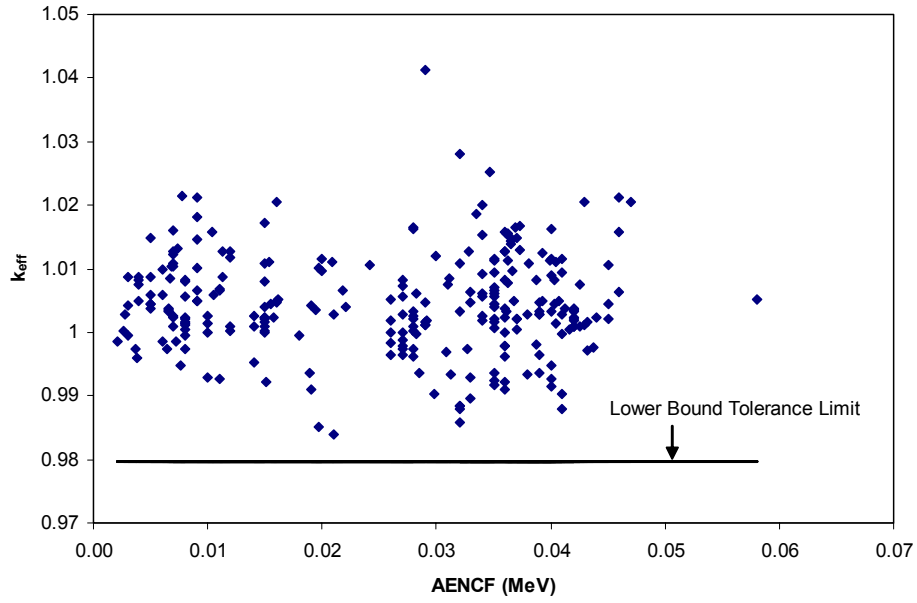

NOTE: AENCF = average energy of a neutron causing fission.

Figure IX-5. Lower-Bound Tolerance Limit Applicable for TRIGA SNF Degraded (Homogeneous) Moderated Configurations

ATTACHMENT X

LBTL CALCULATION AND ROA DETERMINATION FORT ST. VRAIN SNF

ATTACHMENT X

LBTL CALCULATION AND ROA DETERMINATION FOR FORT ST. VRAIN SNF

X.1 INTRODUCTION

This attachment presents the calculations of the LBTL and the determination of ROA for benchmarks that could potentially be applicable to waste package configurations containing Fort St. Vrain (FSVR) SNF. A listing of corroborating and supporting data, models, or information used for the calculation is provided in Table X-1.

Table X-1. Supporting Information and Sources

Description	Source
Guidance for benchmarking a calculational method	Dean and Tayloe 2001
Criticality benchmark experiments, trending parameters, and CL calculations	BSC 2002; BSC 2003b, NEA 2001, Putman 2003
Fort St. Vrain summary report	BSC 2001b

Fort St. Vrain SNF is the representative fuel for the Th/U carbide fuel group, which is one of nine representative fuel groups designated by the National Spent Nuclear Fuel Program for disposal criticality analyses based on the fuel matrix composition, primary fissile isotope and enrichment (DOE 2002, Sections 5.2 and 5.3).

The following information regarding Fort St. Vrain SNF is collected from *Evaluation of Codisposal Viability for Th/U Carbide (Fort Saint Vrain HTGR) DOE-Owned Fuel* (BSC 2001b, Section 2.1.4). Fort St. Vrain SNF consists of small particles (spheres of the order of 0.5-mm diameter) of thorium carbide or thorium and high-enriched uranium carbide mixture, coated with multiple, thin layers of pyrolytic carbon and silicon carbide, which serve as miniature pressure vessels to contain fission products and the U/Th carbide matrix. The coated particles are bound in a carbonized matrix, which forms fuel rods or “compacts” that are loaded into large hexagonal graphite prisms. The graphite prisms (or blocks) are the physical forms that are handled in reactor loading and unloading operations, and which will be loaded into the DOE-standardized SNF canisters.

The Fort St. Vrain fuel element is hexagonal in cross section with dimensions of 360.0 mm (14.172 in.) across flats by 793.0-mm (31.22-in.) high. The active fuel is contained in an array of small-diameter holes, which are parallel with the coolant channels, and occupy alternating positions in a triangular array within the graphite structure. The fuel holes are drilled from the top face of the element to within approximately 7.6 mm (0.3 in.) of the bottom face. A cemented graphite plug that is 12.7-mm (0.5-in.) long closes the top of each fuel channel after the fuel compacts are installed. The fuel holes in all elements are 12.7 mm (0.5 in.) in diameter. The bonded rods (also referred to as “fuel compacts”) of coated fuel particles are stacked within the hole. These rods had a nominal dimension of 12.5 mm (0.49 in.) in diameter. The fuel holes and coolant channels are distributed on a triangular array with a pitch of approximately 18.8 mm (0.74 in.).

A fuel rod is a column of coated fuel particles bonded together by a binder matrix. Fuel rods are cylinders 12.45 mm (0.49 in.) in diameter and 49.276-mm (1.94-in.) long. The chemical characteristics can be varied considerably depending upon blending ratios of the fuel kernels. For initial core loading, and the first reload segment, the Fort St. Vrain fuel rod design utilized a homogeneous mixture of a graphite filler material and carbonized coal tar pitch as the binder. Beginning with the second reload (segment 8), petroleum-derived pitch was used as the binder, and isotropic shim particles, nominally 800 μm in diameter, were used to accommodate differences in heavy metal loading within the compacts. Hot injection molding process is the reference process for Fort St. Vrain fuel rod fabrication.

The individual fuel compact fissile loading in a fuel block may have incorporated either a single or binary fuel mix number as shown in Table X-2.

Table X-2. Fuel Compact Composition Used

Element		Compact Composition (g)	Comments
Thorium (as ThC ₂)		3.447	Based on 10789.97 g Th (EOL), and 3130 compacts per fuel element
Uranium (as UC ₂)		0.474	Based on 1485 g maximum total U (BOL) and 100% ²³⁵ U enrichment (BSC 2001b, p. 2-10, Combination 4)
Silicon (as SiC)		0.800	Based on assumption of uniform coating on particles
Carbon	Pyrolytic Coating	4.100	Based on assumption of uniform coating on particles
	Compact Matrix	3.858	Calculated based on mass differences between loaded fuel elements and components
	Fuel Matrix	0.399	Calculated from ThC ₂ and UC ₂ masses (per compact)
	SiC Layer	0.341	Calculated as a percentage of SiC from reported pure Si mass

Source: BSC 2001b, p. 2-11

The following four isotopic combinations were evaluated and compared for maximum k_{eff} in the same MCNP representation (the load values are reported per fuel element) in the criticality calculations for Fort St. Vrain SNF (BSC 2001b, Section 2.1.4.2). In the following, BOL denotes beginning of life and EOL denotes end of life.

- A. BOL ²³⁵U load of 1,256.61 g, EOL ²³³U load of 135.79 g
- B. BOL ²³⁵U load of 1,172.0 g, EOL ²³³U load of 239.63 g
- C. BOL ²³⁵U load of 1,168 g, EOL ²³³U load of 248.95 g
- D. 1,485.0 g BOL ²³⁵U load as maximum case and EOL ²³³U + ²³⁸U load of 0.0 g.

The current conceptual design for disposing FSVR SNF (BSC 2001b, Section 2.1.1) in the repository contains five HLW glass canisters and one DOE SNF canister loaded with five Fort St. Vrain SNF elements. The DOE SNF canister containing five Fort St. Vrain fuel elements is placed in a carbon steel support tube that becomes the center of the waste package (see Figure X-1). The DOE SNF canister is surrounded by five 4.5-m-long Hanford HLW glass canisters. The five HLW glass canisters are evenly spaced around the DOE SNF canister.

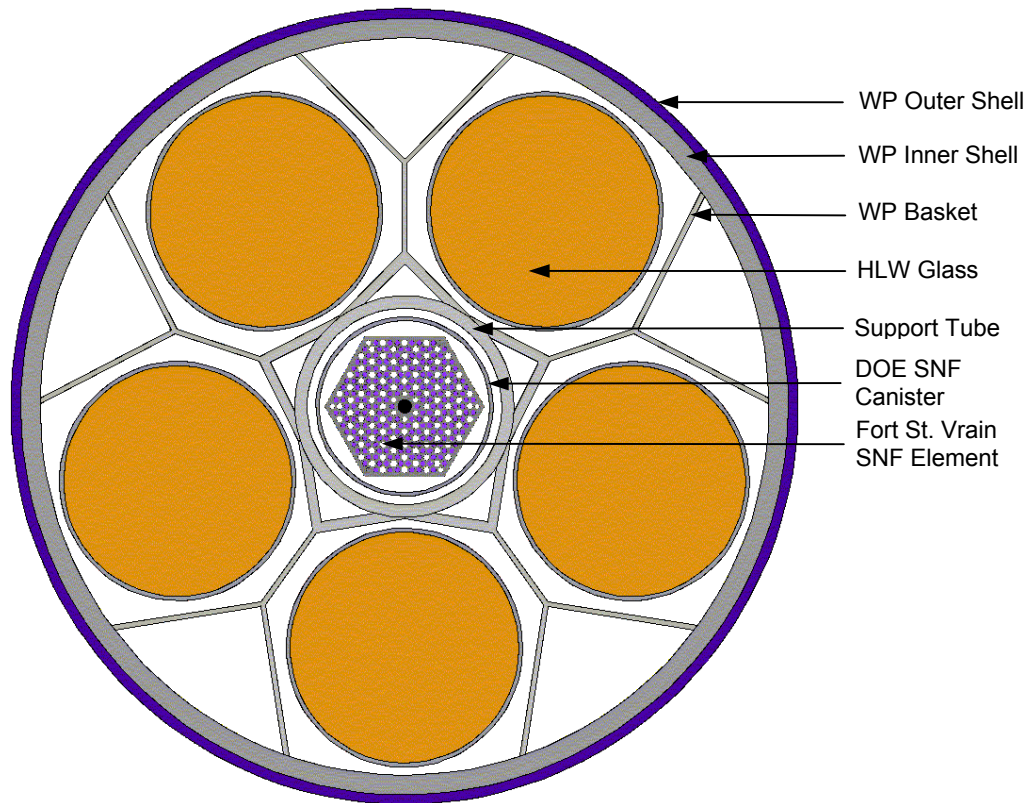

NOTE: WP = waste package, HLW = high-level waste, DOE SNF = U.S. Department of Energy Spent Nuclear Fuel.

Figure X-1. Cross Section of the Waste Package Containing Fort St. Vrain SNF

X.2 SELECTION OF THE CRITICALITY BENCHMARKS

The critical experiments selected for inclusion in benchmarking must be representative of the types of materials, conditions, and parameters to be represented using the calculational method. A sufficient number of experiments with varying experimental parameters should be selected for inclusion in the benchmarking to ensure as wide an area of applicability as feasible and statistically significant results. While there is no absolute guideline for the minimum number of critical experiments necessary to benchmark a computational method, the use of only a few (i.e., less than 10) experiments should be accompanied by a suitable technical basis supporting the rationale for acceptability of the results (Dean and Tayloe 2001, p. 5).

For the present application (codisposal of Fort St. Vrain SNF), the selected benchmark experiments have been grouped in two subsets (BSC 2002, Section 6.1.6) that include moderated heterogeneous and homogeneous experiments. The benchmark experiments are from *International Handbook of Evaluated Criticality Safety Benchmark Experiments* (NEA 2001), unless otherwise noted. The selection process was initially based on prior knowledge regarding the possible degraded configurations of the waste package (BSC 2001b, Section 7), and the subsets have been constructed to accommodate large variations in the range of parameters of the configurations and to provide adequate statistics for LBTL calculations. The selected benchmark experiments for each subset are presented in *Benchmark and Critical Limit Calculation for DOE SNF* (BSC 2002, Section 6.1.6) with MCNP cases constructed and calculation results.

Additional benchmark cases were added the k_{eff} results and their uncertainties are summarized in *Analysis of Critical Benchmark Experiments and Critical Limit Calculation for DOE SNF* (BSC 2003b, Attachment II). Table X-3 presents the list of the benchmark experiments and the number of cases for each subset selected for Fort St. Vrain SNF.

Table X-3. Critical Benchmarks Selected for Fort St. Vrain SNF

Subset	Benchmark Experiment Identification ^a	No. of Cases Included
Heterogeneous Moderated ^b	Experiment with SB Cores ^c	8
	HEU-COMP-THERM-002	25
	HEU-COMP-MIXED-001	4
	HEU-MET-INTER-006	2
	U-233-SOL-THERM-006	6
Homogeneous Moderated ^b	U-233-SOL-THERM-001	5
	U-233-SOL-THERM-002	17
	U-233-SOL-THERM-003	10
	U-233-SOL-THERM-004	8
	U-233-SOL-THERM-005	2
	U-233-SOL-THERM-008	1
	U-233-SOL-THERM-006	6
	HEU-COMP-THERM-002	25
	HEU-COMP-MIXED-001	4
	HEU-MET-INTER-006	2

Source: Subsets defined and evaluated in BSC 2002

NOTES: ^aThe convention for naming the benchmark experiments is from NEA (2001).

^bIdentification of each subset from BSC 2002 has been modified to better reflect the subset's main characteristics. The benchmark experiments in each subset have not been affected.

^cThese experiments are described in Section 5.1.1 in BSC 2003b.

The experiments cover configuration classes IP-1a, IP-1b, IP-2a, IP-3a, IP-3b, IP-3c, and IP-3d for the degraded waste package containing FSVR SNF as described in Section 7.

X.2.1 Range of Applicability of Selected Critical Benchmark Experiments

This section summarizes in a set of tables (Tables X-4, X-5, and X-6) the range of applicability of the experiments listed in Table X-3. The information is partly excerpted from *Benchmark and Critical Limit Calculation for DOE SNF* (BSC 2002), which presents a less comprehensive set of parameters. The tables have been enhanced by adding information regarding the spectral characteristics of the experiments (available for the majority of the benchmarks in NEA [2001]). The purpose is to construct a collective area of applicability that will be used to directly compare with the range of parameters of the codisposal configurations.

Table X-4. Range of Applicability of Critical Benchmark Experiments Selected for Comparison with Heterogeneous Moderated Configurations of Fort St. Vrain SNF

Category/Description	Parameter	Experiment SB-Cores (8 cases)	Experiment HEU-COMP-THERM-002 (25 cases)	Experiment HEU-COMP-MIXED-001 (26 cases)	Experiment HEU-MET-INTER-006 (2 cases)	Experiment U-233-SOL-THERM-006 (6 cases)
Materials/ Fissionable Material	Fissionable Element	Uranium	Uranium	Uranium	Uranium	Uranium
	Physical Form	²³⁵ UO ₂ - ZrO ₂ (3 cases) or ²³³ UO ₂ -ZrO ₂ (5 cases)	Uranium dicarbide	UO ₂	U metal discs	Uranyl nitrate
	Isotopic Composition	92.73 wt. % ²³⁵ U (3 cases) 97.19 wt. % ²³³ U (3 cases) 97.29 wt. % ²³³ U (5 cases)	93.15 wt. % ²³⁵ U	93.15 wt. % ²³⁵ U	93.2 wt. % ²³⁵ U (Average)	97.56 or 97.54 wt. % ²³³ U
	Atomic Density (atoms/b-cm)	²³⁵ U: 3.8791e-03 (3 cases) ²³³ U: 2.23e-4 to 3.84e-3	²³⁵ U: 9.98e-04 to 1.13e-03	²³⁵ U: 4.48e-03 to 1.39e-02	²³⁵ U: 4.48e-02 to 1.15e-02	²³³ U: 5.14e-04 to 8.64e-04
	Temperature	Room Temp.	Room Temp.	Room Temp.	Room Temp.	Room Temp.
Materials/ Moderator	Element	H	H, C	H	C	H
	Physical Form	Water	C: Carbide H: Water	Water, Alcohol-water solution, plexiglas	Graphite	Water in aqueous solution of uranyl nitrate
	Atomic Density (atoms/b-cm)	6.67e-2	C: 8.98e-2 to 9.8e-2 H: 6.67e-2	Fuel Region: 2.16e-2 (few cases) 5.68e-2 (Plexiglas) 6.24e-2 (alcohol-water)	8.54e-2 to 8.58e-2	5.89e-02 to 6.15e-02
	Ratio to Fissile Material (In Region Containing Fissile Material)	37 to 110	C/X: 87 to 88.9	H/X=0 to 49	C discs C/ ²³⁵ U =52	H/X=69 to 121
	Temperature	Room Temp.	Room Temp.	Room Temp.	Room Temp.	Room Temp.
Materials/ Reflector	Material/ Physical Form	Reflected by water	Reflected by water	Reflected by polyethylene	Reflected by Cu	Unreflected
Materials/ Neutron Absorber	Element	None	None	None	None	None
	Physical Form	N/A	N/A	N/A	N/A	N/A
	Atomic Density (atoms/b-cm)	N/A	N/A	N/A	N/A	N/A

Table X-4. Range of Applicability of Critical Benchmark Experiments Selected for Comparison with Heterogeneous Moderated Configurations of Fort St. Vrain SNF (Continued)

Category/Description	Parameter	Experiment SB-Cores (8 cases)	Experiment HEU-COMP-THERM-002 (25 cases)	Experiment HEU-COMP-MIXED-001 (26 cases)	Experiment HEU-MET-INTER-006 (2 cases)	Experiment U-233-SOL-THERM-006 (6 cases)
Geometry	Heterogeneity	Various arrays (triangular or square pitched lattices) of fuel rods surrounded by a blanket region and water	Various arrays (triangular or square pitched lattices) of Al tubed or bare fuel elements (hexagonal graphite blocks containing uranium dicarbide beads) surrounded by water	Complex arrays of cans in rectangular geometry	Cylindrical assembly of alternating U and C discs (53.34-cm diameter)	Arrays of cans containing uranyl nitrate solution in rectangular geometry
	Shape	Rectangular, hexagonal	Cylinder	Cylinder	Cylinder	Cylinder
Neutron Energy	AENCF^b	0.057 to 0.095 MeV	0.0094 to 0.0244 MeV	0.1045 to 0.8015 MeV	0.3423 to 0.3864 MeV	0.0344 to 0.0599 MeV
	EALF^b	Not available	0.054 to 0.145 eV	Not available	Not available	Not available
	Neutron Energy Spectra^a	Not available	T: 15.2 to 49.4% I: 22.5 to 35.2% F: 28.1 to 50.6%	Not available	Not available	Not available
	Fission Rate vs. Neutron Energy^a	Not available	T: 85.6 to 95.8% I: 3.6 to 12.8% F: 0.5 to 1.6%	Not available	Not available	Not available

Source: BSC 2002 and NEA 2001, Spectra; BSC 2003b, Section 5.1.1; and Putman 2003 for SB cases

NOTES: ^a Spectral range defined as follows: thermal (T) [0 to 1 eV], intermediate (I) [1eV to 100 keV], fast (F) [100 keV to 20 MeV].

^b AENCF = average energy of a neutron causing fission, EALF = energy of average lethargy causing fission.

Table X-5. Range of Applicability of Critical Benchmark Experiments Selected for Comparison with Homogeneous Moderated Configurations of Fort St. Vrain SNF (Set 1)

Category/Description	Parameter	Experiment U-233-SOL-THERM-001 (5 cases)	Experiment U-233-SOL-THERM-002 (17 cases)	Experiment U-233-SOL-THERM-003 (10 cases)	Experiment U-233-SOL-THERM-004 (8 cases)	Experiment U-233-SOL-THERM-005 (2 cases)
Materials/ Fissionable Material	Fissionable Element	Uranium	Uranium	Uranium	Uranium	Uranium
	Physical Form	Uranyl nitrate	Uranyl nitrate	Uranyl fluoride	Uranyl nitrate	Uranyl nitrate
	Isotopic Composition	97.7 wt. % ²³³ U	98.7 wt. % ²³³ U	98.7 wt. % ²³³ U	98.7 wt. % ²³³ U	98.7 wt. % ²³³ U
	Atomic Density (atoms/b-cm)	²³³ U: 4.33e-05 to 5.00e-05	²³³ U: 8.71e-05 to 9.84e-04	²³³ U: 8.56e-05 to 1.55e-03	²³³ U: 4.15e-04 to 9.84e-04	²³³ U: 1.27e-04 and 1.60e-04
	Temperature	Room Temp.	Room Temp.	Room Temp.	Room Temp.	Room Temp.
Materials/ Moderator	Element	H	H	H	H	H
	Physical Form	Solution	Solution	Solution	Solution	Solution
	Atomic Density (atoms/b-cm)	6.63e-02 to 6.64e-02	5.62e-02 to 6.56e-02	6.05e-02 to 6.57e-02	5.62e-02 to 6.22e-02	6.50e-02 and 6.54e-02
	Ratio to Fissile Material	1324 to 1533	57.1 to 752.6	39.4 to 775	57.1 to 149.2	405 and 514
	Temperature	Room Temp.	Room Temp.	Room Temp.	Room Temp.	Room Temp.
Materials/ Reflector	Material/ Physical Form	Unreflected	Reflected by paraffin	Reflected by paraffin	Reflected by paraffin	Reflected by water
Materials/ Neutron Absorber	Element	B	None	None	None	None
	Physical Form	Solution	N/A	N/A	N/A	N/A
	Atomic Density (atoms/b-cm)	B10: 2.65e-0 to 1.01e-6	N/A	N/A	N/A	N/A
Geometry	Heterogeneity	Solution contained in an Al sphere	Solution contained in an Al sphere	Solution contained in single Al cylindrical vessel	Solution contained in single Al cylindrical vessel	2 configurations: first has solution contained in a spherical Al vessel; second has solution contained in single Al cylindrical vessel
	Shape	Sphere	Sphere	Cylindrical	Cylindrical	Cylindrical, spherical
Neutron Energy	AENCF ^b	0.0038 to 0.0043 MeV	0.0056 to 0.0490 MeV	0.0056 to 0.0693 MeV	0.0208 to 0.0493 MeV	0.0078 to 0.0094 MeV
	EALF ^b	0.0392 to 0.0417 eV	0.0464 to 0.471 eV	0.046 to 1.03 eV	0.133 to 0.486 eV	Not available
	Neutron Energy Spectra ^a	T: 48.9 to 52.5% I: 21.0 to 22.6% F: 26.5 to 28.5%	T: 7.7 to 42.2% I: 24.8 to 33.9% F: 33.0 to 58.3%	T: 5.2 to 42.6% I: 24.6 to 34.2% F: 32.7 to 60.6%	T: 7.8 to 17.2% I: 32.4 to 34.0% F: 50.4 to 58.3%	Not available
	Fission Rate vs. Neutron Energy ^a	T: 94.0 to 94.8% I: 5.0 to 5.8% F: 0.2%	T: 63.7 to 92.5% I: 7.1 to 33.5% F: 0.3 to 2.8%	T: 54.5 to 92.7% I: 7.0 to 41.5% F: 0.3 to 4.0%	T: 63.8 to 79.5% I: 19.3 to 33.4% F: 1.2 to 2.8%	Not available

Source: BSC 2002 and NEA 2001, Spectra

NOTES: ^aSpectral range defined as follows: thermal (T) [0 to 1 eV, intermediate (I) [1eV to 100 keV], fast (F) [100 keV to 20 MeV].

^bAENCF = average energy of a neutron causing fission, EALF = energy of average lethargy causing fission.

Table X-6. Range of Applicability of Critical Benchmark Experiments Selected for Comparison with Homogeneous Moderated Configurations of Fort St. Vrain SNF (Set 2)

Category/Description	Parameter	Experiment U-233-SOL-THERM-008 (1 case)	Experiment U-233-SOL-THERM-006 (6 cases)	Experiment HEU-COMP-THERM-002 (25 cases)	Experiment HEU-COMP-MIXED-001 (26 cases)	Experiment HEU-MET-INTER-006 (2 cases)
Materials/ Fissionable Material	Fissionable Element	Uranium	Uranium	Uranium	Uranium	Uranium
	Physical Form	Uranyl nitrate	Uranyl nitrate	Uranium dicarbide	UO ₂	U metal discs
	Isotopic Composition	97.67 wt. % ²³³ U	97.56 or 97.54 wt. % ²³³ U	93.15 wt. % ²³⁵ U	93.15 wt. % ²³⁵ U	93.2 wt. % ²³⁵ U (Average)
	Atomic Density (atoms/b-cm)	²³³ U: 3.34e-05	²³³ U: 5.14e-04 to 8.64e-04	²³⁵ U: 9.98e-04 to 1.13e-03	²³⁵ U: 4.48e-03 to 1.39e-02	²³⁵ U: 4.48e-02 to 1.15e-02
	Temperature	Room Temp.	Room Temp.	Room Temp.	Room Temp.	Room Temp.
Materials/ Moderator	Element	H	H	H,C	H	C
	Physical Form	Solution	Water in aqueous solution of uranyl nitrate	C: Carbide H: Water	Water, Alcohol-water solution, Plexiglas	Graphite
	Atomic Density (atoms/b-cm)	6.64e-02	5.89e-02 to 6.15e-02	C: 8.98e-2 to 9.8e-2 H: 6.67e-2	Fuel Region: 2.16e-2 ; 5.68e-2 (Plexiglas) 6.24e-2 (alcohol-water)	8.54e-2 to 8.58e-2
	Ratio to Fissile Material	1985	H/X=69 to 121	C/X: 87 to 88.9	H/X=0 to 49	C discs C/X=52
	Temperature	Room Temp.	Room Temp.	Room Temp.	Room Temp.	Room Temp.
Materials/ Reflector	Material/ Physical Form	Unreflected	Unreflected	Reflected by water	Reflected by polyethylene	Reflected by Cu
Materials/ Neutron Absorber	Element	None	None	None	None	None
	Physical Form	N/A	N/A	N/A	N/A	N/A
	Atomic Density (atoms/b-cm)	N/A	N/A	N/A	N/A	N/A
Geometry	Heterogeneity	Solution contained in an Al sphere	Complex arrays of cans containing uranyl nitrate solution in rectangular geometry	Various arrays (triangular or square pitched lattices) of Al tubed or bare fuel elements surrounded by water	Complex arrays of cans in rectangular geometry	Cylindrical assembly of alternating U and C discs (53.34 cm diameter)
	Shape	Sphere	Cylinder	Cylinder	Cylinder	Cylinder
Neutron Energy	AENCF ^b	0.0030 MeV	0.0344 to 0.0599 MeV	0.0094 to 0.0244	0.1045 to 0.8015 MeV	0.3423 to 0.3864 MeV
	EALF ^b	0.037 eV	Not available	0.054 to 0.145 eV	Not available	Not available
	Neutron Energy Spectra ^a	T: 57.0% I: 19.3% F: 23.7%	Not available	T: 15.2 to 49.4% I: 22.5 to 35.2% F: 28.1 to 50.6%	Not available	Not available
	Fission Rate vs. Neutron Energy ^a	T: 95.5% I: 4.3% F: 0.2%	Not available	T: 85.6 to 95.8% I: 3.6 to 12.8% F: 0.5 to 1.6%	Not available	Not available

Source: BSC 2002 and NEA 2001, Spectra

NOTES: ^a Spectral range defined as follows: thermal (T) [0 to 1 eV], intermediate (I) [1eV to 100 keV], fast (F) [100 keV to 20 MeV].

^b AENCF = average energy of a neutron causing fission, EALF = energy of average lethargy causing fission.

X.3 CALCULATION OF THE LOWER-BOUND TOLERANCE LIMIT

The following results are excerpted from *Analysis of Critical Benchmark Experiments and Critical Limit Calculation for DOE SNF* (BSC 2003b), which present in detail the methodology and calculations performed for evaluating the LBTL for each set of configurations of the waste package containing Fort St. Vrain SNF. The calculated k_{eff} values for the critical benchmarks are taken from *Analysis of Critical Benchmark Experiments and Critical Limit Calculation for DOE SNF* (BSC 2003b, Attachment II). The results of the trending parameter analysis for the critical benchmark subsets representative for moderated intact (heterogeneous) configurations of the waste package containing Fort St. Vrain SNF are presented in Table X-7. The parameters in the following tables describe the regression statistics for the linear trend evaluations (see Attachment III for definitions). The P-value parameter gives a direct estimation of the probability of having a linear trending due to chance only.

Table X-7. Trending Parameter Results for the Critical Benchmark Subset Representative for Moderated Intact (Heterogeneous) Configurations of the Waste Package Containing FSVR SNF

Trend Parameter	n	Intercept	Slope	r^2	T	$t_{0.025,n-2}$	P-Value	Goodness-of-Fit Tests	Valid Trend
AENCF ^a	73	1.0099	-0.0226	0.35	-6.1832	1.960	3.55E-08	Passed	Yes
H/X	71	0.9982	1.19E-04	0.2537	4.8430	1.960	7.6E-06	Passed	Yes

Source: BSC 2003b, p. 48

NOTE: ^aAENCF = average energy of a neutron causing fission.

Figure X-2 presents the k_{eff} values and the calculated lower-bound tolerance limit. Details for the calculation of the lower-bound tolerance limit function are provided in *Analysis of Critical Benchmark Experiments and Critical Limit Calculation for DOE SNF* (BSC 2003b, Attachment I) with the results as follows:

$$\text{Lower-bound tolerance limit} = 0.9575 \text{ for } 0 \text{ MeV} < \text{AENCF} < 0.386 \text{ MeV}$$

$$\text{Lower-bound tolerance limit} = -0.0226 \times \text{AENCF} + 0.9674 \text{ for } 0.386 \text{ MeV} < \text{AENCF} < 0.8015 \text{ MeV}$$

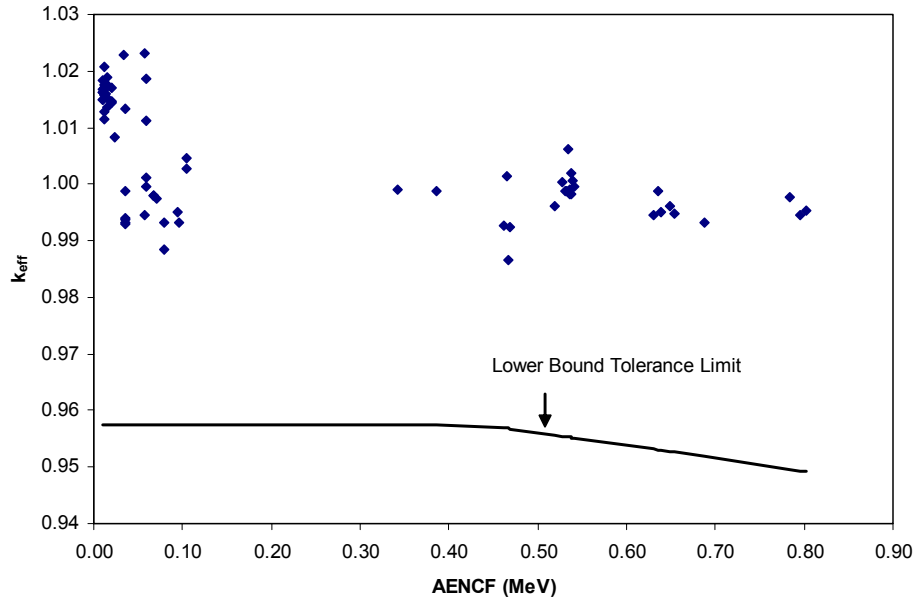

Figure X-2. Lower-Bound Tolerance Limit Applicable for Fort St. Vrain SNF for Intact (Heterogeneous) Moderated Configurations

The results of the trending parameter analysis for the critical benchmark subset representative for moderated degraded (homogeneous) configurations of the waste package containing Fort St. Vrain SNF are presented in Table X-8.

Table X-8. Trending Parameter Results for the Critical Benchmark Subset Representative for Moderated Degraded Configurations of the Waste Packages Containing Fort St. Vrain SNF

Trend Parameter	n	Intercept	Slope	r ²	T	t _{0.025,n-2}	P-Value	Goodness-of-Fit Tests	Valid Trend
AENCF ^a	108	1.0079	-0.0183	0.2098	-5.3049	1.960	6.22E-07	Passed	Yes
H/X	103	1.0064	-4.14E-06	0.0245	-1.5911	1.960	0.1147	Failed	No

Source: BSC 2003b, p. 50

NOTE: ^aAENCF = average energy of a neutron causing fission.

Figure X-3 presents the k_{eff} values and the calculated LBTL. Details for the calculation of the LBTL function are provided in *Analysis of Critical Benchmark Experiments and Critical Limit Calculation for DOE SNF* (BSC 2003b, Attachment I) with the results as follows:

Lower-bound tolerance limit = 0.9608 for 0 MeV < AENCF < 0.4625 MeV

Lower-bound tolerance limit = $-0.0183 \times \text{AENCF} + 0.9687$ for 0.4625 MeV < AENCF < 0.8015 MeV

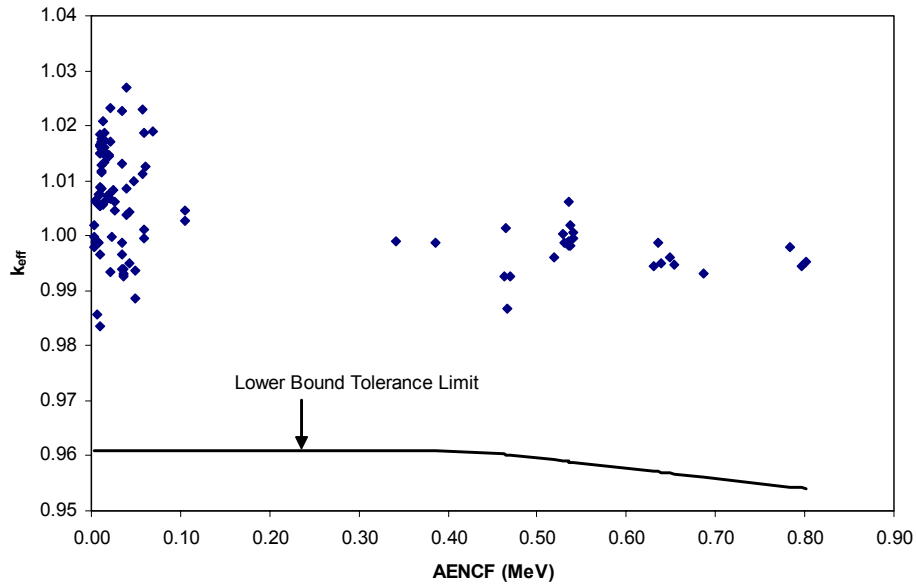

NOTE: AENCF = average energy of a neutron causing fission.

Figure X-3. Lower-Bound Tolerance Limit Applicable for Fort St. Vrain SNF for Degraded (Homogeneous) Moderated Configurations

Table X-9 presents a summary of the results of the analyses performed on the subsets of critical benchmark experiments applicable to the waste package containing Fort St. Vrain SNF and the calculated LBTL values or functions.

Table X-9. Lower-Bound Tolerance Limits For Benchmark Subsets Representative For Configurations of Waste Packages Containing Fort St. Vrain SNF

Subset	Trend Parameter	Test for Normality	Applied Computational Method	Lower-Bound Tolerance Limit
Intact (Heterogeneous) Moderated	AENCF ^a	N/A	LUTB ^a	0.9575 for 0 < AENCF < 0.386 -0.0226 × AENCF + 0.9674 for 0.386 MeV < AENCF < 0.8015 MeV
Degraded (Homogeneous) Moderated	AENCF ^a	N/A	LUTB ^a	0.9608 for 0 < AENCF < 0.4625 -0.0183 × AENCF + 0.9687 for 0.4625 MeV < AENCF < 0.8015 MeV

Source: BSC 2003b, p. 52

NOTE: ^a AENCF = average energy of a neutron causing fission, LUTB = lower uniform tolerance band, N/A = not applicable.

INTENTIONALLY LEFT BLANK

ATTACHMENT XI

LBTL CALCULATION AND ROA DETERMINATION FOR SHIPPINGPORT PWR

ATTACHMENT XI

LBTL CALCULATION AND ROA DETERMINATION FOR SHIPPINGPORT PWR

XI.1 INTRODUCTION

This attachment presents the calculations of the LBTL and the determination of ROA for benchmarks that could potentially be applicable to waste package configurations containing Shippingport PWR SNF. A listing of corroborating and supporting data, models, or information used for the calculation is provided in Table XI-1.

Table XI-1. Supporting Information and Sources

Description	Source
Guidance for benchmarking a calculational method	Dean and Tayloe 2001
Criticality benchmark experiments, trending parameters, and CL calculations	BSC 2002; BSC 2003b, NEA 2001
Shippingport PWR summary report	CRWMS M&O 2000a

NOTE: CL = critical limit, PWR = pressurized water reactor.

The Shippingport PWR SNF is the representative fuel for the highly enriched uranium oxide (HEU) SNF group. This group is one of nine representative fuel groups designated by the National Spent Nuclear Fuel Program for disposal criticality analyses based on the fuel matrix composition, primary fissile isotope and enrichment (DOE 2002, Sections 5.2 and 5.3).

The following information regarding Shippingport PWR SNF is collected from *Evaluation of Codisposal Viability for HEU Oxide (Shippingport PWR) DOE-Owned Fuel* (CRWMS M&O 2000a, Section 2.1.4).

The Shippingport PWR was a “seed and blanket” reactor that underwent multiple modifications to provide higher thermal outputs. The blankets will be shipped and handled as individual fuel assemblies. The low enrichments of the blankets (less than one percent) allow the use of the same packaging associated with either PWR or BWR commercial fuels. Therefore, this analysis does not address the disposal of blanket assemblies in the repository.

The waste package that holds the DOE SNF canister with Shippingport PWR fuel also contains five HLW glass pour canisters and a carbon steel basket. The DOE SNF canister is placed in a support tube that becomes the center of the waste package, as shown in Figure XI-1. The five HLW canisters are evenly spaced around the DOE SNF canister. The DOE SNF canister is designed to hold one Shippingport PWR fuel assembly. The basket structure of the DOE SNF canister comprises a stainless-steel rectangular grid that is a 208-mm square. An isometric of the DOE SNF canister containing one Shippingport PWR fuel assembly is shown in Figure XI-2.

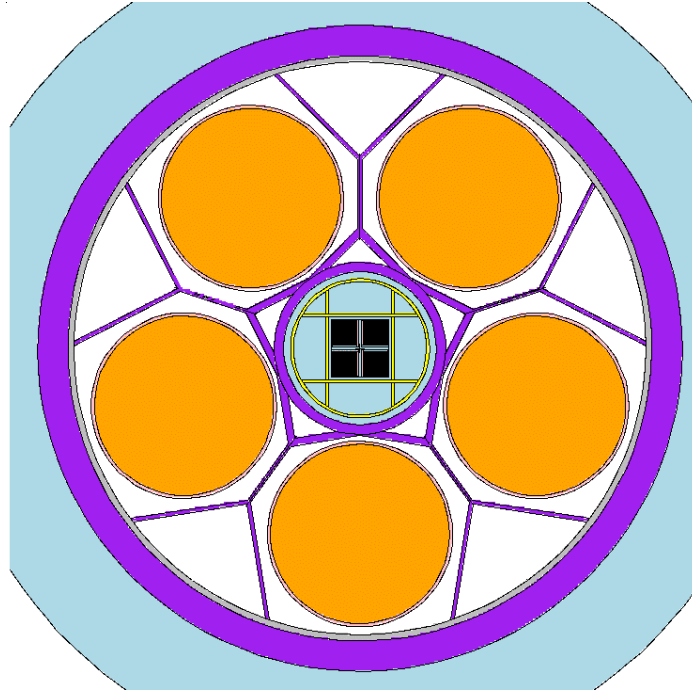

Figure XI-1. 5-HLW/DOE SNF Waste Package with Shippingport PWR Fuel Assembly

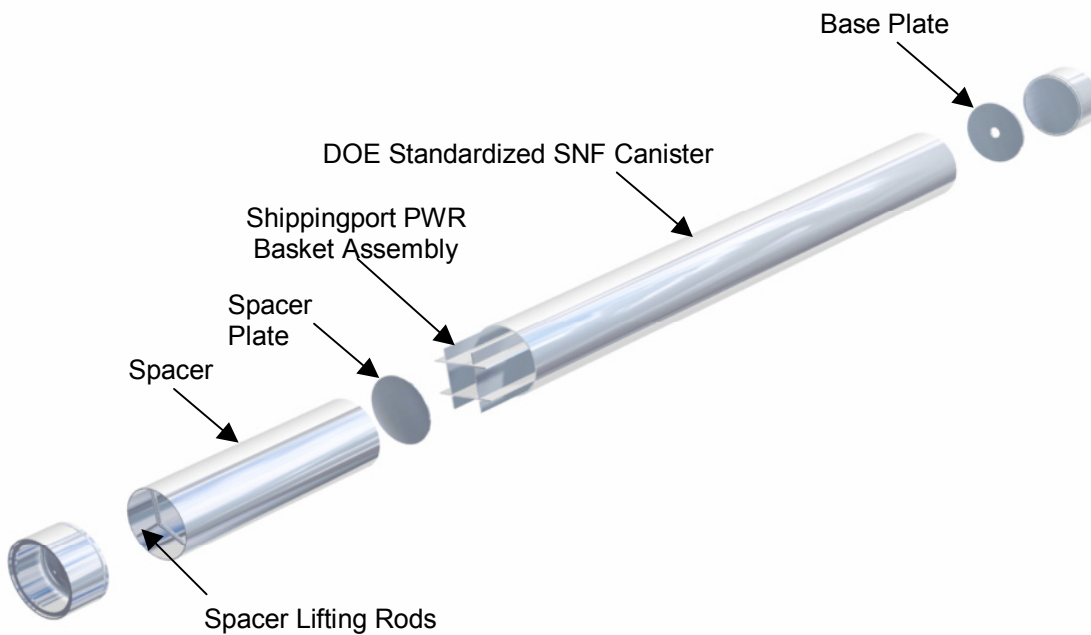

Figure XI-2. Isometric View of the Shippingport PWR SNF Canister

Two seeds, Seed 1 and Seed 2, which had identical geometrical dimensions but different ^{235}U enrichment and chemical composition, were designed for Shippingport PWR Core 2 operation. The assembly is composed of Zircaloy-4 and consists of four subassemblies and a cruciform-shaped channel in the center to accommodate a control rod. Figure XI-3 shows the

cross section of a single subassembly. Each subassembly is composed of 19 fuel plates and 20 channels. Each plate is formed by sandwiching an enriched U-Zr alloy strip between two Zircaloy-4 cover plates and four side strips. There are five types of fuel plates located in the assembly. As shown in Table XI-2, the three assembly regions (i.e., Zones 1, 2, and 3) have different fissile loadings.

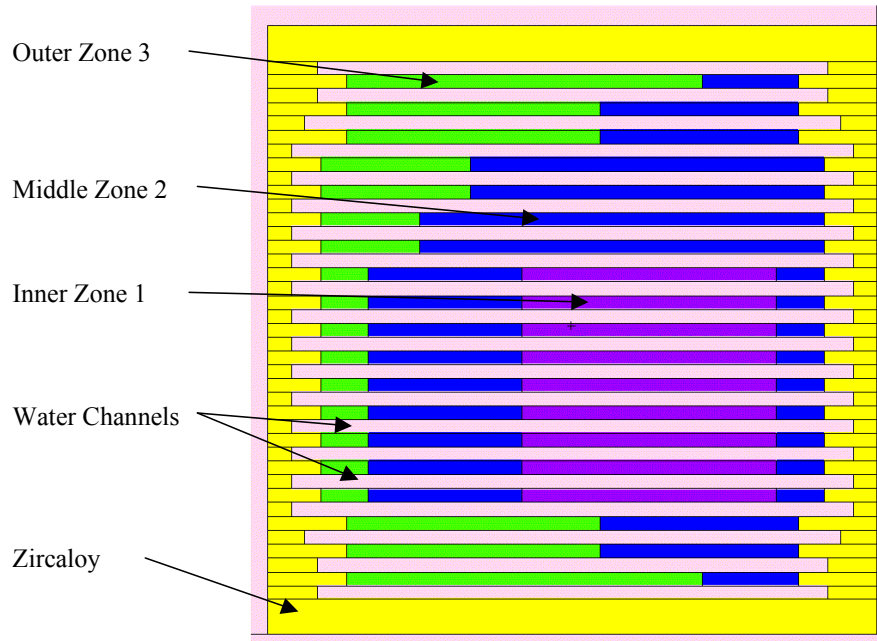

Figure XI-3. Shippingport PWR Core 2 Seed 2 SNF Subassembly Cross Section

Table XI-2. Geometry and Material Specifications for the Shippingport PWR Core 2 Seed 2 Assembly

Component	Material	Characteristic	Value
Assembly		Total mass (kg)	357
		Length (cm)	265.43
		Transverse dimensions (cm)	18.7325
Fuel plate		Active fuel length (cm)	246.38
Fuel wafer	UO ₂ -ZrO ₂ -CaO 93.2% ²³⁵ U beginning of life (BOL) enrichment	Length (cm)	2.07264
		Width (cm)	0.64008
		Thickness (cm)	0.09144
Fuel Zone 1	UO ₂ -ZrO ₂ -CaO	Weight (wt) % UO ₂	54.9
		wt. % CaO	5.2
		wt. % ZrO ₂	39.9
		Fissile loading (kg)	7.076
Fuel Zone 2	UO ₂ -ZrO ₂ -CaO	wt. % UO ₂	40.2
		wt. % CaO	5.8
		wt. % ZrO ₂	54
		Fissile loading (kg)	8.987

Table XI-2. Geometry and Material Specifications for the Shippingport PWR Core 2 Seed 2 Assembly (Continued)

Component	Material	Characteristic	Value
Fuel Zone 3	UO ₂ -ZrO ₂ -CaO	wt. % UO ₂	26.5
		wt. % CaO	6.4
		wt. % ZrO ₂	67.1
		Fissile loading (kg)	3.437
Borated stainless steel	Stainless Steel Type 304	Mass (g)	6,001
	B-10	Mass (g)	26
	B-11	Mass (g)	114
Spacer rings	Inconel X	Mass (g)	546
Chrome plating	Cr	Mass (g)	325
Cladding	Zircaloy-4	Thickness (cm)	0.05207

Source: CRWMS M&O 2000a, Section 2.1.4

XI.2 SELECTION OF THE CRITICALITY BENCHMARK EXPERIMENTS

The critical experiments selected for inclusion in benchmarking must be representative of the types of materials, conditions, and parameters to be represented using the calculational method. A sufficient number of experiments with varying experimental parameters should be selected for inclusion in the benchmarking to ensure as wide an area of applicability as feasible and statistically significant results. While there is no absolute guideline for the minimum number of critical experiments necessary to benchmark a computational method, the use of only a few (i.e., less than 10) experiments should be accompanied by a suitable technical basis supporting the rationale for acceptability of the results (Dean and Tayloe 2001, p. 5).

For the present application (codisposal of Shippingport PWR SNF), only benchmark experiments including moderated heterogeneous experiments (BSC 2002, Section 6.1.1) have been selected. The benchmark experiments are from *International Handbook of Evaluated Criticality Safety Benchmark Experiments* (NEA 2001), unless otherwise noted. The selection process was initially based on prior knowledge regarding the possible degraded configurations of the waste package (CRWMS M&O 2000a), and the subset has been constructed to accommodate large variations in the range of parameters of the configurations and to provide adequate statistics for LBTL calculations. The selected benchmark are presented in *Benchmark and Critical Limit Calculation for DOE SNF* (BSC 2002) with MCNP cases constructed and calculation results. The cases, k_{eff} results, and their uncertainties are also summarized in *Analysis of Critical Benchmark Experiments and Critical Limit Calculation for DOE SNF* (BSC 2003b, Attachment II). Table XI-3 presents the list of the benchmark experiments and the number of cases selected for Shippingport PWR SNF.

Table XI-3. Critical Benchmarks Selected for Shippingport PWR SNF

Subset	Benchmark Experiment Identification ^a	No. of Cases Included
Heterogeneous Moderated ^b	HEU-MET-THERM-006	23
	HEU-COMP-THERM-003	15
	HEU-COMP-THERM-005	1
	HEU-COMP-THERM-006	3
	HEU-COMP-THERM-007	3
	HEU-COMP-THERM-008	2
	HEU-COMP-THERM-010	21
	HEU-COMP-THERM-011	3
	HEU-COMP-THERM-012	2
	HEU-COMP-THERM-013	2
	HEU-COMP-THERM-014	2

Source: Subsets defined in BSC 2002

NOTES: ^a The convention for naming the benchmark experiments is from NEA (2001).

^b identification of each subset from BSC 2002 has been changed to better reflect the subset's main characteristics. The benchmark experiments in each subset have not been affected.

The experiments cover configuration classes IP-1a, IP-1b, IP-3a, IP-3b, and IP-3c for the degraded waste package containing Shippingport PWR SNF as described in Section 7.

XI.2.1 Range of Applicability of Selected Critical Benchmark Experiments

This section summarizes in a set of tables (Tables XI-4 through XI-6) the range of applicability of the experiments listed in Table XI-3. The information is partly excerpted from *Benchmark and Critical Limit Calculation for DOE SNF* (BSC 2002, Section 6.2), which presents a less comprehensive set of parameters. The tables have been enhanced by adding information regarding the spectral characteristics of the experiments (available for the majority of the benchmarks in NEA [2001]). The purpose is to construct a collective area of applicability that will be used to directly compare with the range of parameters of the codisposal configurations.

Table XI-4. Range of Applicability of Critical Benchmark Experiments Selected for Comparison with Heterogeneous Moderated Configurations of Shippingport PWR SNF (Set 1)

Category/Description	Parameter	Experiment HEU-MET-THERM-006 (23 cases)	Experiment HEU-COMP-THERM-003 (15 cases)	Experiment HEU-COMP-THERM-005 (1 case)	Experiment HEU-COMP-THERM-006 (3 cases)
Materials/Fissionable Material	Fissionable Element	Uranium	Uranium	Uranium	Uranium
	Physical Form	U-Al alloy (fuel plates)	UO ₂ + Cu	UO ₂ + Cu	UO ₂ + Cu
	Isotopic Composition	93.17 wt. % ²³⁵ U	79.66 wt. % ²³⁵ U	79.66 wt. % ²³⁵ U	79.66 wt. % ²³⁵ U
	Atomic Density (atoms/b-cm)	²³⁵ U: 1.85E-03 ²³⁸ U: 1.13E-04 For solution (cases 19 to 23): ²³⁵ U: 1.02E-05 ²³⁸ U: 6.98E-07	²³⁵ U: 3.63e-03 ²³⁸ U: 8.72e-04	²³⁵ U: 4.42e-03 ²³⁸ U: 1.06 e-03	²³⁵ U: 4.42e-03 ²³⁸ U: 1.06 e-03
	Temperature	Room Temp.	Room Temp.	Room Temp.	Room Temp.

Table XI-4. Range of Applicability of Critical Benchmark Experiments Selected for Comparison with Heterogeneous Moderated Configurations of Shippingport PWR SNF (Set 1) (Continued)

Category/Description	Parameter	Experiment HEU-MET-THERM-006 (23 cases)	Experiment HEU-COMP-THERM-003 (15 cases)	Experiment HEU-COMP-THERM-005 (1 case)	Experiment HEU-COMP-THERM-006 (3 cases)
Materials/ Moderator	Element	Hydrogen	H	Hydrogen	Hydrogen
	Physical Form	Water	Water	Water	Water
	Atomic Density (atoms/b-cm)	6.67e-02 For solution: 6.62e-02 to 6.64e-02	6.67e-02	6.67e-02	6.67e-02
	Ratio to fissile Material (In Region Containing Fissile Material)	134 to 500	51 to 349	23	30 to 716
	Temperature	Room Temp.	Room Temp.	Room Temp.	Room Temp.
Materials/ Reflector	Material/ Physical Form	Reflected by water or dilute aqueous uranyl nitrate solutions	Reflected by water and stainless steel	Reflected by water and stainless steel	Reflected by water and stainless steel
Materials/ Neutron Absorber	Element	B (few cases)	None	None	None
	Physical Form	In solution	N/A	N/A	N/A
	Atomic Density (atoms/b-cm)	B-10: 4.27E-06 to 9.57E-06 (only in 4 cases)	N/A	N/A	N/A
Geometry	Heterogeneity	Rectangular arrays of fuel elements with various spacing	Cylindrical two zones hexagonally pitched lattice of cross-shaped fuel rods	Hexagonally pitched array of fuel rod clusters (each containing a hexagonally pitched lattice of cross-shaped fuel rods)	Cylindrical hexagonally pitched lattice of cross-shaped fuel rods
	Shape	Slab (fuel plates)	Cylinder	Cylinder	Cylinder
Neutron Energy	AENCF	0.0100 to 0.0150 MeV	0.0139 to 0.0467 MeV	0.076 MeV	0.0104 to 0.0720 MeV
	EALF	0.05 to 0.09 eV	0.06 to 0.40 eV	1.46 eV	0.05 to 1.12 eV
	Neutron Energy Spectra ^a	T: 18.5 to 33.3% I: 25.3 to 36.5% F: 41.1 to 45%	T: 9.9 to 37.7% I: 27.4 to 37% F: 35.9 to 53.1%	T: 6.5% I: 38.4% F: 55.1%	T: 4.9 to 47% I: 23.2 to 37.7% F: 29.8-57.4%
	Fission Rate vs. Neutron Energy ^a	T: 89.9 to 95% I: 4.4 to 9.2% F: 0.5 to 0.9%	Handbook T: 75.3 to 94.1% I: 5.2 to 21.9% F: 0.7 to 2.8%	T: 61.3% I: 33.8% F: 4.9%	T: 64.1 to 96.1% I: 3.4 to 31.5% F: 0.5 to 4.4%

Source: BSC 2002 and NEA 2001, Spectra

NOTES: ^aSpectral range defined as follows: thermal (T) [0 to 1 eV], intermediate (I) [1eV to 100 keV], fast (F) [100 keV to 20 MeV].

Table XI-5. Range of Applicability of Critical Benchmark Experiments Selected for Comparison with Heterogeneous Moderated Configurations of Shippingport PWR SNF (Set 2)

Category/ Description	Parameter	Experiment HEU-COMP- THERM-007 (3 cases)	Experiment HEU-COMP- THERM-008 (2 cases)	Experiment HEU-COMP- THERM-010 (21 cases)	Experiment HEU-COMP- THERM-011 (3 cases)
Materials/ Fissionable Material	Fissionable Element	Uranium	Uranium	Uranium	Uranium
	Physical Form	UO ₂ + Cu	UO ₂ + Cu	UO ₂ + BeO	UO ₂ + Al alloy
	Isotopic Composition	79.66 wt. % ²³⁵ U	79.66 wt. % ²³⁵ U	62.4 wt. % wt. % ²³⁵ U	80 wt. % ²³⁵ U
	Atomic Density (atoms/b-cm)	²³⁵ U: 3.63e-03 ²³⁸ U: 8.72e-04	²³⁵ U: 4.42e-03 ²³⁸ U: 1.06 e-03	²³⁵ U: 3.83E-03 ²³⁸ U: 2.24E-03 For solution (cases 20-21): ²³⁵ U: 9.43E-06 ²³⁸ U: 7.44E-07	²³⁵ U: 2.66e-03 ²³⁸ U: 6.47e-03
	Temperature	Room Temp.	Room Temp.	Room Temp.	Room Temp.
Materials/ Moderator	Element	Hydrogen	Hydrogen	Hydrogen	Hydrogen
	Physical Form	Water; ZrH rods	Water	Water	Water
	Atomic Density (atoms/b-cm)	6.67e-02 (H ₂ O) 5.34e-02 (ZrH)	6.67e-02	6.67e-02 For solution: 6.65e-02 to 6.68e-02	6.68e-02
	Ratio to Fissile Material (In Region Containing Fissile Material)	60 to 91	25	36 to 302	170
	Temperature	Room Temp.	Room Temp.	Room Temp.	Room Temp.
Materials/ Reflector	Material/ Physical Form	Reflected by water and stainless steel	Reflected by water and stainless steel	Reflected by water	Reflected by water
Materials/ Neutron Absorber	Element	None	Boron	B as Boric Acid (few cases)	None
	Physical Form	N/A	B ₄ C rods	In solution	N/A
	Atomic Density (atoms/b-cm)	N/A	B10: 3.92e-03 to 1.12e-03	B-10: 4.32E-07-3.49E-06	N/A
Geometry	Heterogeneity	Cylindrical hexagonally pitched double lattice of cross-shaped fuel rods and ZrH rods	Cylindrical hexagonally double lattice of fuel rods and B ₄ C rod	Square or cylindrical assemblies with square or hexagonal pitched lattices	Square clusters of cylindrical fuel rods arranged in square geometry
	Shape	Cylinder	Cylinder	Cylinder	Cylinder
Neutron Energy	AENCF	0.034 to 0.048 MeV	0.088 to 0.092 MeV	0.023 to 0.080 MeV	0.047 to 0.053 MeV
	EALF	0.257 to 0.445 eV	2.50 to 2.90 eV	0.080 to 0.880 eV	0.430 to 0.720 eV
	Neutron Energy Spectra^a	T: 8.0 to 11.9% I: 36.9 to 38.0% F: 51.2 to 54.0%	T: 2.5 to 3.0% I: 38.9 to 39.1% F: 57.9 to 58.6%	T: 6.1 to 28.2% I: 25.4 to 36.7% F: 46.4 to 57.2%	T: 6.6 to 10.0% I: 37.6 to 40.1% F: 52.4 to 53.5%
	Fission Rate vs. Neutron Energy^a	T: 73.8 to 80.9% I: 17.1 to 23.3% F: 2 to 2.9%	T: 53.6 to 55.2% I: 39.2 to 40.6% F: 5.6 to 5.8%	T: 67.7 to 92.5% I: 6.3 to 27.8% F: 1.2 to 4.5%	T: 68.4 to 74.2% I: 22.8 to 28.2% F: 3.0 to 3.4%

Source: BSC 2002 and NEA 2001, Spectra

NOTE: ^a Spectral range defined as follows: thermal (T) [0 to 1 eV], intermediate (I) [1eV to 100 keV], fast (F) [100 keV to 20 MeV].

Table XI-6. Range of Applicability of Critical Benchmark Experiments Selected for Comparison with Heterogeneous Moderated Configurations of Shippingport PWR SNF (Set 3)

Category/ Description	Parameter	Experiment HEU-COMP- THERM-012 (2 cases)	Experiment HEU-COMP- THERM-013 (2 cases)	Experiment HEU-COMP- THERM-014 (2 cases)
Materials/ Fissionable Material	Fissionable Element	Uranium	Uranium	Uranium
	Physical Form	UO ₂ + Al alloy	UO ₂ + Al alloy	UO ₂ + Al alloy
	Isotopic Composition	80 wt. % ²³⁵ U	80 wt. % ²³⁵ U	80 wt. % ²³⁵ U
	Atomic Density (atoms/b-cm)	²³⁵ U: 2.66e-03 ²³⁸ U: 6.47e-03	²³⁵ U: 2.66e-03 ²³⁸ U: 6.47e-03	²³⁵ U: 2.66e-03 ²³⁸ U: 6.47e-03
	Temperature	Room Temp.	Room Temp.	Room Temp.
Materials/ Moderator	Element	Hydrogen	Hydrogen	Hydrogen
	Physical Form	Water	Water	Water
	Atomic Density (atoms/b-cm)	6.68e-02	6.68e-02	6.68e-02
	Ratio to Fissile Material (In Region Containing Fissile Material)	35	40	170
	Temperature	Room Temp.	Room Temp.	Room Temp.
Materials/ Reflector	Material/Physical Form	Reflected by water	Reflected by water	Reflected by water
Materials/ Neutron Absorber	Element	None	None	None
	Physical Form	N/A	N/A	N/A
	Atomic Density (atoms/b-cm)	N/A	N/A	N/A
Geometry	Heterogeneity	Square clusters of cylindrical fuel rods arranged in square geometry	Square clusters of cylindrical fuel rods arranged in square geometry	Square clusters of cylindrical fuel rods arranged in square geometry
	Shape	Cylinder	Cylinder	Cylinder
Neutron Energy	AENCF	0.051 to 0.055 MeV	0.043 to 0.048 MeV	0.023 to 0.026 MeV
	EALF	0.43 to 0.56 eV	0.32 to 0.45 eV	0.10 to 0.12 eV
	Neutron Energy Spectra ^a	T: 7.3 to 9.4% I: 37.1 to 38.4% F: 53.5 to 54.3%	T: 8.6 to 12.1% I: 36 to 37.9% F: 51.9 to 53.5%	T: 17.0 to 20.6% I: 31.4 to 33.1% F: 48.0 to 49.9%
	Fission Rate vs. Neutron Energy ^a	T: 71.8 to 74.7% I: 22.2 to 24.8% F: 3.1 to 3.4%	T: 73.7 to 77.6% I: 19.7 to 23.2% F: 2.7 to 3.1%	T: 87.9 to 89.8% I: 8.9 to 10.6% F: 1.3 to 1.5%

Source BSC 2002 and NEA 2001, Spectra

NOTE: ^aSpectral range defined as follows: thermal (T) [0 to 1 eV], intermediate (I) [1eV to 100 keV], fast (F) [100 keV to 20 MeV].

XI.3 CALCULATION OF LOWER-BOUND TOLERANCE LIMIT

The following results are excerpted from *Analysis of Critical Benchmark Experiments and Critical Limit Calculation for DOE SNF* (BSC 2003b) which present in detail the methodology and calculations performed for evaluating the LBTL for each set of configurations of the waste package containing Shippingport PWR SNF. The calculated k_{eff} values for the critical

benchmarks are taken from *Analysis of Critical Benchmark Experiments and Critical Limit Calculation for DOE SNF* (BSC 2003b, Attachment II). The results of the trending parameter analysis for the critical benchmark subset representative for moderated intact (heterogeneous) configurations of the waste package containing Shippingport PWR SNF are presented in Table XI-7. The parameters in the following tables describe the regression statistics for the linear trend evaluations (see Attachment III for definitions). The P-value parameter gives a direct estimation of the probability of having a linear trending due to chance only.

Table XI-7. Trending Parameter Results for the Critical Benchmark Subset Representative for Moderated Intact (Heterogeneous) Configurations of the Waste Package Containing Shippingport PWR SNF

Trend Parameter	n	Intercept	Slope	r ²	T	t _{0.025,n-2}	P-Value	Goodness-of-Fit Tests	Valid Trend
AENCF	77	1.0064	-0.2336	0.3500	-6.3542	1.960	1.5E-8	Passed	Yes

Source: BSC 2003b, p. 26

Figure XI-4 presents the k_{eff} values and the calculated LBTL. Details for the calculation of the LBTL function are provided in *Analysis of Critical Benchmark Experiments and Critical Limit Calculation for DOE SNF* (BSC 2003b, Attachment I) with results as follows:

Lower-bound tolerance limit = 0.969 for $0 \text{ MeV} < \text{AENCF} < 0.0278 \text{ MeV}$

Lower-bound tolerance limit = $-0.2336 \times \text{AENCF} + 0.9755$ for $0.0278 \text{ MeV} < \text{AENCF} < 0.0922 \text{ MeV}$

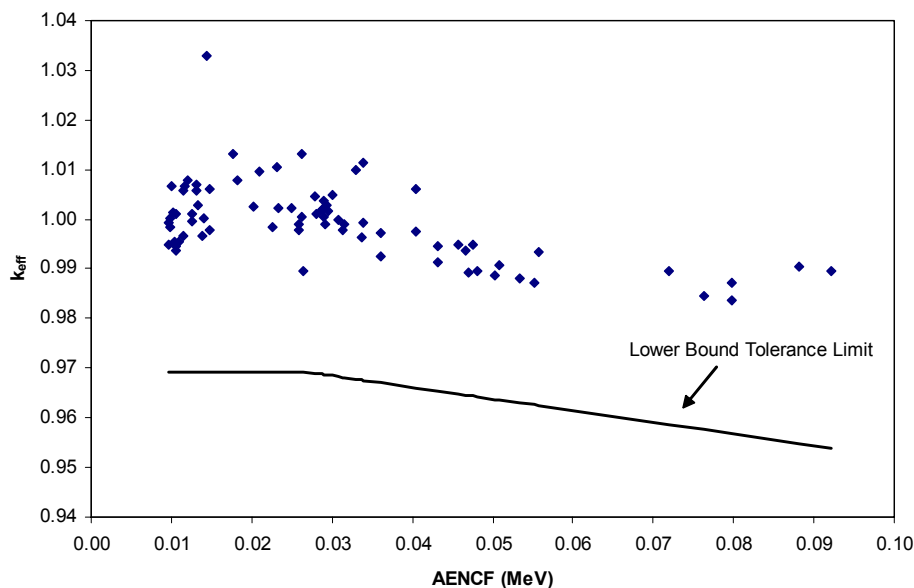

NOTE: AENCF = average energy of a neutron causing fission.

Figure XI-4. Lower-Bound Tolerance Limit Applicable for Shippingport PWR SNF for Intact (Heterogeneous) Moderated Configurations

INTENTIONALLY LEFT BLANK

ATTACHMENT XII

**LBTL CALCULATION AND ROA DETERMINATION FOR CONFIGURATIONS
EXTERNAL TO THE WASTE PACKAGE**

ATTACHMENT XII

LBTL CALCULATION AND ROA DETERMINATION FOR CONFIGURATIONS EXTERNAL TO THE WASTE PACKAGE

XII.1 INTRODUCTION

This attachment presents the calculations of the LBTL and the determination of ROA for benchmarks that could potentially be applicable to configurations external to the waste package. The calculations includes experiments applicable to highly enriched uranium (HEU), intermediate enriched uranium (IEU), low enriched uranium (LEU), mixture of uranium and plutonium, and ^{233}U systems presented in Sections XII.2 through XII.6, respectively. A listing of corroborating and supporting data, models, or information used for the calculation is provided in Table XII-1.

Table XII-1. Supporting Information and Sources

Description	Source
Guidance for benchmarking a calculational method	Dean and Tayloe 2001
Benchmark Experiments	NEA 2003, BSC 2002 and Moscalu 2004

External accumulation of fissile material can occur in the near-field or the far-field. The near-field is defined as the invert, which is the part of the drift that is directly underneath the waste package. The invert is made up of crushed tuff with a high porosity. The far-field is defined as several meters of tuff underneath the drift, which has a distribution of fractures and lithophysae (cavities in rock).

XII.2 HEU SYSTEMS

Selection of the criticality benchmark experiments for HEU systems, determination of the range of applicability of the selected benchmarks, and the calculation of the LBTL are discussed in the following three sections.

XII.2.1 Selection of the Criticality Benchmark Experiments

The criticality experiments selected for inclusion in the benchmarking of the criticality computational method must be representative of the types of materials, conditions, and parameters to be represented. A sufficient number of experiments with varying experimental parameters should be selected for inclusion in the benchmarking to ensure as wide an area of applicability as feasible and statistically significant results. While there is no absolute guideline for the minimum number of critical experiments necessary to benchmark a computational method, the use of only a few (i.e., less than 10) experiments should be accompanied by a suitable technical basis supporting the rationale for acceptability of the results (Dean and Tayloe 2001, p. 5).

For the present application (configurations with mixtures of IEU fissile material external to the waste package), the criticality benchmark experiments have been selected based on their fissile content, moderator and geometry. The benchmark experiments are from the *International*

Handbook of Evaluated Criticality Safety Benchmark Experiments (NEA 2003) unless otherwise noted. The set of criticality benchmark experiments has been constructed to accommodate large variations in the range of parameters of the configurations and also to provide adequate statistics for the LBTL calculations.

The selected benchmark experiments containing a total of 187 individual cases are presented in Table XII-2 along with the results of the MCNP code calculations. All cases have been run using the isotopic libraries described in Table 2 (Section 4.2.2).

Table XII-2. Critical Benchmarks Selected for Validation of the Criticality Model for External Configurations Containing Mixture Highly Enriched in ²³⁵U

Experiment	Case Name	Benchmark Values		Calculated Values (MCNP)		
		k _{eff}	σ _{exp}	k _{eff}	σ _{calc}	AENCF
Experiment HEU-MET -MIXED-005 (5 cases)	hmm5_1	1.0007	0.0027	1.01308	0.00057	0.307
	hmm5_2	1.0003	0.0028	1.0217	0.00055	0.247
	hmm5_3	1.0012	0.0029	1.01904	0.00052	0.212
	hmm5_4	1.0016	0.003	1.0145	0.0006	0.3175
	hmm5_5	1.0005	0.004	1.00682	0.00052	0.377
Experiment HEU-MET-THERM-001 (1 case)	hmt001	1.0010	0.0060	1.0097	0.0010	0.0215
Experiment HEU-MET-THERM-014 (1 case)	hmt14	0.9939	0.0015	1.0125	0.0004	0.0233
Experiment HEU-COMP-MIXED-001 (26 cases)	hcm-1	1.0000	0.0059	1.0027	0.001	0.1045
	hcm-2	1.0012	0.0059	1.0059	0.0011	0.1053
	hcm-5	0.9985	0.0056	0.9963	0.001	0.7833
	hcm-6	0.9953	0.0056	0.9899	0.001	0.7962
	hcm-7	0.9997	0.0038	0.9949	0.001	0.8015
	hcm-8	0.9984	0.0052	0.9915	0.0011	0.6872
	hcm-9	0.9983	0.0052	0.9931	0.0011	0.6536
	hcm-10	0.9979	0.0052	0.9941	0.001	0.6494
	hcm-11	0.9983	0.0052	0.9934	0.0011	0.6385
	hcm-12	0.9972	0.0052	0.9960	0.0011	0.6358
	hcm-13	1.0032	0.0053	0.9977	0.0011	0.6309
	hcm-15	1.0083	0.005	0.9949	0.0011	0.4671
	hcm-16	1.0001	0.0046	0.9926	0.0011	0.4692
	hcm-17	0.9997	0.0046	1.0012	0.0011	0.4647
	hcm-18	1.0075	0.0046	1.0000	0.001	0.4625
	hcm-19	1.0039	0.0047	1.0000	0.0011	0.5191
	hcm-20	1.006	0.0065	1.0051	0.0015	0.5357
	hcm-21	1.0026	0.0064	1.0046	0.0016	0.5378
	hcm-22	1.0013	0.0064	0.9995	0.0016	0.5371
	hcm-23	0.9995	0.0053	1.0056	0.0015	0.535
	hcm-24	1.002	0.0053	1.0003	0.0016	0.5352
	hcm-25	0.9983	0.0053	0.9970	0.0014	0.5333
	hcm-26	0.9998	0.0053	1.0001	0.0015	0.5283
	hcm-27	0.9991	0.0053	0.9978	0.0016	0.5302
	hcm-28	1.0037	0.0053	1.0033	0.0015	0.541
	hcm-29	0.9992	0.0052	0.9998	0.0014	0.5401

Table XII-2. Critical Benchmarks Selected for Validation of the Criticality Model for External Configurations Containing Mixture Highly Enriched in ²³⁵U (Continued)

Experiment	Case Name	Benchmark Values		Calculated Values (MCNP)		
		k _{eff}	σ _{exp}	k _{eff}	σ _{calc}	AENCF
Experiment HEU-COMP-MIXED-002 (23 cases)	hcm02_1	1.0000	0.0085	0.9866	0.0017	0.868
	hcm02_10	1.0000	0.0081	0.9856	0.0019	0.57
	hcm02_11	1.0000	0.0088	0.9829	0.0019	0.568
	hcm02_12	1.0000	0.0078	0.9900	0.0019	0.556
	hcm02_13	1.0000	0.0083	0.9874	0.0017	0.559
	hcm02_14	1.0000	0.0112	0.9880	0.0017	0.735
	hcm02_15	1.0000	0.0111	0.9850	0.0017	0.73
	hcm02_16	1.0000	0.0108	0.9861	0.0017	0.735
	hcm02_17	1.0000	0.0112	0.9861	0.0016	0.732
	hcm02_18	1.0000	0.0111	0.9902	0.0017	0.727
	hcm02_19	1.0000	0.0107	0.9910	0.0017	0.712
	hcm02_2	1.0000	0.0088	0.9907	0.0017	0.865
	hcm02_20	1.0000	0.0108	0.9824	0.0018	0.735
	hcm02_21	1.0000	0.0092	0.9843	0.0016	0.902
	hcm02_22	1.0000	0.009	0.9879	0.0019	0.899
	hcm02_23	1.0000	0.0093	0.9866	0.0016	0.896
	hcm02_3	1.0000	0.0093	0.9914	0.0016	0.724
	hcm02_4	1.0000	0.0087	0.9923	0.0017	0.716
	hcm02_5	1.0000	0.0089	0.9933	0.0017	0.722
	hcm02_6	1.0000	0.0093	0.9852	0.0018	0.574
	hcm02_7	1.0000	0.0086	0.9813	0.0019	0.578
	hcm02_8	1.0000	0.0068	0.9943	0.0018	0.537
	hcm02_9	1.0000	0.0076	0.9913	0.0018	0.541
Experiment HEU-SOL-THERM-001 (10 cases)	hest1-1	1.0000	0.0025	1.00241	0.00131	0.01582
	hest1-2	1.0000	0.0025	0.99816	0.00209	0.03873
	hest1-3	1.0000	0.0025	1.00453	0.00199	0.01546
	hest1-4	1.0000	0.0025	1.0013	0.00203	0.0405
	hest1-5	1.0000	0.0025	1.00361	0.00166	0.00651
	hest1-6	1.0000	0.0025	1.01038	0.00187	0.00678
	hest1-7	1.0000	0.0025	1.0023	0.00201	0.01501
	hest1-8	1.0000	0.0025	1.00505	0.00213	0.0161
	hest1-9	1.0000	0.0025	0.99973	0.00212	0.04099
	hest1-10	1.0000	0.0025	0.99468	0.00178	0.00757
Experiment HEU-SOL-THERM-002 (14 cases)	hest2-1	1.0000	0.002	1.00548	0.00148	0.01558
	hest2-2	1.0000	0.002	1.00773	0.00235	0.01516
	hest2-3	1.0000	0.002	1.00219	0.0022	0.0374
	hest2-4	1.0000	0.002	1.00809	0.00242	0.03541
	hest2-5	1.0000	0.002	1.01049	0.0023	0.01622
	hest2-6	1.0000	0.002	1.00968	0.00215	0.01496
	hest2-7	1.0000	0.002	1.00691	0.00224	0.03747
	hest2-8	1.0000	0.002	1.01131	0.00206	0.03511
	hest2-9	1.0000	0.002	1.00348	0.00209	0.00654
	hest2-10	1.0000	0.002	1.00937	0.00202	0.00663

Table XII-2. Critical Benchmarks Selected for Validation of the Criticality Model for External Configurations Containing Mixture Highly Enriched in ²³⁵U (Continued)

Experiment	Case Name	Benchmark Values		Calculated Values (MCNP)		
		k _{eff}	σ _{exp}	k _{eff}	σ _{calc}	AENCF
Experiment HEU-SOL-THERM-002 (14 cases) (continued)	hest2-11	1.0000	0.002	1.00875	0.00211	0.01595
	hest2-12	1.0000	0.002	1.0127	0.00209	0.01487
	hest2-13	1.0000	0.002	0.99869	0.00232	0.03676
	hest2-14	1.0000	0.002	1.01062	0.00238	0.03377
Experiment HEU-SOL-THERM-007 (17 cases)	CASE_1	1.0000	0.0035	1.0164	0.0019	0.0071
	CASE_2	1.0000	0.005	1.0178	0.0025	0.0361
	CASE_3	1.0000	0.0035	1.0084	0.0019	0.0071
	CASE_4	1.0000	0.0035	1.0144	0.0019	0.0357
	CASE_5	1.0000	0.0035	1.0112	0.0019	0.0835
	CASE_6	1.0000	0.0035	1.0045	0.0023	0.0376
	CASE_7	1.0000	0.0035	1.0067	0.0019	0.0085
	CASE_8	1.0000	0.0035	1.0026	0.0025	0.0390
	CASE_9	1.0000	0.0035	1.0087	0.0021	0.0088
	CASE_10	1.0000	0.0035	1.0144	0.0018	0.0087
	CASE_11	1.0000	0.0035	1.0097	0.0020	0.0356
	CASE_12	1.0000	0.0035	1.0091	0.0019	0.0088
	CASE_13	1.0000	0.0035	1.0095	0.0023	0.0345
	CASE_14	1.0000	0.0035	1.0097	0.0021	0.0363
	CASE_15	1.0000	0.0035	1.0046	0.0021	0.0369
	CASE_16	1.0000	0.0035	1.0043	0.0022	0.0368
	CASE_17	1.0000	0.0035	1.0120	0.0023	0.0368
Experiment HEU-SOL-THERM-008 (5 cases evaluated)	heust81	1.0000	0.003	1.00316	0.00134	0.00661
	heust83	1.0000	0.003	0.9973	0.0019	0.00644
	heust86	1.0000	0.003	1.00969	0.0023	0.03669
	heust89	1.0000	0.003	1.00373	0.00116	0.0066
	hest813	1.0000	0.003	1.00331	0.002	0.03616
Experiment HEU-SOL-THERM-009 (4 cases)	heust9c1	1.0000	0.0057	1.0051	0.0006	0.058
	heust9c2	1.0000	0.0057	1.0045	0.0006	0.045
	heust9c3	1.0000	0.0057	1.0047	0.0007	0.029
	heust9c4	1.0000	0.0057	0.9994	0.0007	0.018
Experiment HEU-SOL-THERM-033 (26 cases)	hst33d_02a	1.0000	0.0111	1.00007	0.00128	0.036
	hst33d_02b	1.0000	0.0108	0.99792	0.00113	0.036
	hst33d_02c	1.0000	0.0065	0.99796	0.00119	0.036
	hst33d_03a	1.0000	0.0114	1.00634	0.00108	0.033
	hst33d_03b	1.0000	0.0111	1.00608	0.00115	0.034
	hst33d_03c	1.0000	0.007	1.01079	0.00118	0.032
	hst33d_04a	1.0000	0.0114	1.0057	0.00109	0.035
	hst33d_04b	1.0000	0.0111	1.0116	0.00117	0.035
	hst33d_05a	1.0000	0.0111	1.01126	0.00114	0.035
	hst33d_05b	1.0000	0.0108	1.00608	0.00128	0.035
	hst33d_06a	1.0000	0.0111	1.00936	0.00112	0.035
	hst33d_06b	1.0000	0.0108	1.00915	0.00114	0.034
	hst33d_07a	1.0000	0.0111	1.00453	0.00107	0.035
hst33d_07b	1.0000	0.0108	1.00406	0.00109	0.035	

Table XII-2. Critical Benchmarks Selected for Validation of the Criticality Model for External Configurations Containing Mixture Highly Enriched in ²³⁵U (Continued)

Experiment	Case Name	Benchmark Values		Calculated Values (MCNP)		
		K _{eff}	σ _{exp}	K _{eff}	σ _{calc}	AENCF
Experiment HEU-SOL-THERM-033 (26 cases) (continued)	hst33d_08a	1.0000	0.0111	1.00558	0.00113	0.034
	hst33d_08b	1.0000	0.0108	1.00213	0.00111	0.035
	hst33d_09a	1.0000	0.0111	1.00228	0.00115	0.036
	hst33d_09b	1.0000	0.0108	0.99359	0.00113	0.035
	hst33d_09c	1.0000	0.0104	0.99619	0.00116	0.036
	hst33d_10a	1.0000	0.0114	1.00267	0.00113	0.034
	hst33d_10c	1.0000	0.007	1.00333	0.00103	0.032
	hst33d_10d	1.0000	0.0104	0.99286	0.00111	0.033
	hst33d_11a	1.0000	0.0111	1.00669	0.0011	0.035
	hst33d_11b	1.0000	0.0108	1.00176	0.00097	0.034
	hst33d_12a	1.0000	0.0111	1.00386	0.00112	0.036
	hst33d_12b	1.0000	0.0108	1.00165	0.00107	0.035
Experiment HEU-SOL-THERM-038 (28 cases evaluated)	CASE_1	1.0000	0.0025	0.9995	0.0004	0.0437
	CASE_2	1.0000	0.0025	0.9989	0.0004	0.0405
	CASE_3	1.0000	0.0025	1.0022	0.0004	0.0421
	CASE_4	1.0000	0.0025	1.0007	0.0004	0.0438
	CASE_5	1.0000	0.0025	1.0011	0.0004	0.0434
	CASE_6	1.0000	0.0025	0.9985	0.0004	0.0405
	CASE_7	1.0000	0.0032	1.0013	0.0004	0.0420
	CASE_8	1.0000	0.0026	1.0016	0.0004	0.0416
	CASE_9	1.0000	0.0033	1.0009	0.0004	0.0412
	CASE_10	1.0000	0.0026	1.0007	0.0004	0.0425
	CASE_11	1.0000	0.0025	1.0017	0.0004	0.0434
	CASE_12	1.0000	0.0025	1.0006	0.0004	0.0434
	CASE_13	1.0000	0.0050	1.0066	0.0004	0.0440
	CASE_14	1.0000	0.0050	1.0060	0.0004	0.0443
	CASE_15	1.0000	0.0050	1.0065	0.0004	0.0442
	CASE_16	1.0000	0.0050	1.0065	0.0004	0.0442
	CASE_17	1.0000	0.0026	1.0013	0.0004	0.0432
	CASE_18	1.0000	0.0032	1.0017	0.0004	0.0431
	CASE_19	1.0000	0.0032	1.0011	0.0004	0.0430
	CASE_20	1.0000	0.0032	1.0021	0.0004	0.0430
	CASE_21	1.0000	0.0025	0.9994	0.0004	0.0412
	CASE_22	1.0000	0.0027	0.9998	0.0004	0.0407
	CASE_23	1.0000	0.0027	0.9997	0.0004	0.0408
	CASE_24	1.0000	0.0026	1.0027	0.0004	0.0438
	CASE_25	1.0000	0.0032	1.0025	0.0004	0.0429
	CASE_26	1.0000	0.0032	1.0018	0.0004	0.0429
	CASE_27	1.0000	0.0032	1.0012	0.0004	0.0483
	CASE_28	1.0000	0.0025	1.0013	0.0004	0.0425
Experiment HEU-SOL-THERM-042 (8 cases)	CASE_1	0.9957	0.0045	0.9982	0.0003	0.0024
	CASE_2	0.9965	0.0040	0.9983	0.0003	0.0024
	CASE_3	0.9994	0.0028	1.0011	0.0002	0.0022
	CASE_4	1.0000	0.0034	1.0025	0.0002	0.0021

Table XII-2. Critical Benchmarks Selected for Validation of the Criticality Model for External Configurations Containing Mixture Highly Enriched in ²³⁵U (Continued)

Experiment	Case Name	Benchmark Values		Calculated Values (MCNP)		
		k _{eff}	σ _{exp}	k _{eff}	σ _{calc}	AENCF
Experiment HEU-SOL-THERM-042 (8 cases) (continued)	CASE_5	1.0000	0.0034	0.9997	0.0002	0.0020
	CASE_6	1.0000	0.0037	1.0005	0.0002	0.0021
	CASE_7	1.0000	0.0036	1.0011	0.0002	0.0021
	CASE_8	1.0000	0.0035	1.0013	0.0001	0.0021
Experiment HEU-SOL-THERM-043 (3 cases)	heust43c1	0.9986	0.0017	0.9995	0.0007	0.014
	heust43c2	0.9995	0.0041	1.0082	0.0004	0.003
	heust43c3	0.999	0.0044	1.0033	0.0004	0.003
Experiment HEU-SOL-THERM-044 (16 cases)	hst4410	0.9944	0.0077	0.9909	0.0018	0.039
	hst4411	0.9944	0.0078	0.9847	0.002	0.041
	hst4412	0.9944	0.0078	0.9872	0.0017	0.040
	hst4413	0.9964	0.0067	1.0000	0.0018	0.042
	hst4416	0.9974	0.0062	1.0178	0.0018	0.043
	hst4417	0.9964	0.0057	0.9987	0.0017	0.044
	hst4419	0.9974	0.0063	1.0079	0.0018	0.045
	hst4444	0.9984	0.0057	1.0004	0.0017	0.045
	hst4449	0.9964	0.0047	1.0116	0.0017	0.034
	hst4450	0.9946	0.0047	0.9881	0.0018	0.038
	hst4451	0.9984	0.0057	1.0047	0.0017	0.046
	hst4453	0.9984	0.0064	1.0189	0.0018	0.047
	hst4454	0.9984	0.0065	1.0142	0.0015	0.046
	hst4455	0.9984	0.0065	1.0196	0.0017	0.046
	hst447	0.9944	0.0097	0.9948	0.0018	0.037
hst448	0.9946	0.0083	0.9955	0.0021	0.042	

Source: Moscalu 2004, Section 5.1

The experiments listed in Table XII-2 cover configuration classes NF-1 through NF-5 and FF-1 through FF-3 for configurations containing mixtures of highly enriched uranium external to the waste package.

XII.2.2 Range of Applicability of Selected Critical Benchmark Experiments

Tables XII-3 through XII-5 summarize the range of applicability of the experiments listed in Table XII-2. The information is excerpted from Moscalu (2004, Section 5.1).

Table XII-3. Range of Applicability of Critical Benchmark Experiments Selected for Comparison with External Configurations Containing Mixtures Highly Enriched in ²³⁵U (Set 1)

Category/Description	Parameter	Experiment HEU-MET-MIXED-005 (5 cases)	Experiment HEU-MET-THERM-001 (1 case)	Experiment HEU-MET-THERM-014 (1case)	Experiment HEU-COMP-MIXED-001 (26 cases)	Experiment HEU-COMP-MIXED-002 (23 cases)
Materials/ Fissionable Material	Fissionable Element	Uranium	Uranium	Uranium	Uranium	Uranium
	Physical Form	Uranium metal pellets	Uranium metal foils	Uranium metal foils	UO ₂	UO ₂
	Isotopic Composition	89.39 wt% ²³⁵ U	93.23 wt% ²³⁵ U	93.23 wt% ²³⁵ U	93.15 wt% ²³⁵ U	89.42 and 89.6 wt% ²³⁵ U
	Atomic Density (atoms/b-cm)	²³⁵ U: 4.24e-02	²³⁵ U: 3.84e-02 to 4.28e-02	²³⁵ U: 3.84e-02 to 4.38e-02	²³⁵ U: 4.48e-03 to 1.39e-02	²³⁵ U: 1.26e-02 and 1.32e-02
	Temperature	Room Temp.	Room Temp.	Room Temp.	Room Temp.	Room Temp.
Materials/ Moderator	Element	Si as scatterer H in sand	H, C Si as scatterer	H, C Si as scatterer	H	H and Deuterium (D)
	Physical Form	SiO ₂ pellets interspersed with U pellets	Plates of polyethylene and silicon glass	Plates of polyethylene and silicon glass	Water, alcohol-water solution, Plexiglas	Mixture water with heavy water
	Atomic Density (atoms/b-cm)	Si: 1.99e-02 H: 2.65e-05	H: 8.23e-02 to 8.28e-02 C: 4.11e-02 to 4.14e-02 Si: 2.17 to 2.24e-02	H: 8.19e-02 to 8.34e-02 C: 4.10e-02 to 4.17e-02 Si: 2.20 to 2.28e-02	Fuel Region: 2.16e-2 (7 cases) 5.68e-2 (Plexiglas) 6.24e-2 (alcohol-water)	H: 7.36e-03 to 6.67e-02 D: 0 to 5.91e-02
	Ratio to Fissile Material	Not available	Not available	H/X: Not available Si/ ²³⁵ U = 42	0 - 49	Not available
	Temperature	Room Temp.	Room Temp.	Room Temp.	Room Temp.	Room Temp.
Materials/ Reflector	Material/ Physical Form	Reflected by polyethylene, SiO ₂ sand and concrete	Reflected by polyethylene	Reflected by polyethylene	Reflected by polyethylene	Reflected by water stainless steel and concrete walls
Materials/ Neutron Absorber	Element	Boron	None	None	None	None
	Physical Form	Impurity in SiO ₂	N/A	N/A	N/A	N/A
	Atomic Density (atoms/b-cm)	¹⁰ B: 4.40e-08	N/A	N/A	N/A	N/A
Geometry	Heterogeneity	Complex hexagonal geometry of pellets in Al tubes	Rectangular column of plates and foils	Rectangular column of plates and foils	Complex arrays of cans in rectangular geometry	Hexagonal array of tubes containing UO ₂ in a cylindrical tank
	Shape	Cylinder	Parallelepiped	Parallelepiped	Cylinder	Cylinder
Neutron Energy	AENCF ^b	0.212 to 0.377 MeV	0.0212 MeV	0.0234 MeV	0.1045 to 0.8015 MeV	0.537 to 0.899 MeV
	EALF ^b	1.48 to 5150 eV	0.0865 eV	Not Available	0.438 to 2.14e-03	237 to 4.61e04 eV
	Neutron Energy Spectra ^a	T: 0.3 to 25.0 % I: 28.1 to 50.5 % F: 46.8 to 54.2 %	T: 22.7 % I: 27.7 % F: 49.7 %	Not Available	T: 4.3 to 26.1 % I: 14.2 to 25.9 % F: 48.3 to 81.4 %	T: 0.4 to 8.0 % I: 16.0 to 33.8 % F: 65.1 to 82.9 %
	Fission Rate vs. Neutron Energy ^a	T: 4.4 to 68.4 % I: 20.5 to 68.4 % F: 11.1 to 27.2 %	T: 91.2 % I: 7.7 % F: 1.2 %	Not Available	T: 25.4 to 78.0 % I: 16.4 to 43.1 % F: 5.6 to 49.3 %	T: 3.8 to 34.5 % I: 26.8 to 54.6 % F: 31.9 to 63.6 %

Source: Moscalu 2004, Section 5.1

NOTES: ^a Spectral range defined as follows: thermal (T) [0 to 1 eV], intermediate (I) [1eV to 100 keV], fast (F) [100 keV to 20 MeV].

^b AENCF = average energy of a neutron causing fission, EALF = energy of average lethargy causing fission.

Table XII-4. Range of Applicability of Critical Benchmark Experiments Selected for Comparison with External Configurations Mixtures Highly Enriched in ²³⁵U (Set 2)

Category/Description	Parameter	Experiment HEU-SOL-THERM-001 (10 cases)	Experiment HEU-SOL-THERM-002 (14 cases)	Experiment HEU-SOL-THERM-007 (17 cases)	Experiment HEU-SOL-THERM-008 (5 cases)	Experiment HEU-SOL-THERM-009 (4 cases)
Materials/ Fissionable Material	Fissionable Element	Uranium	Uranium	Uranium	Uranium	Uranium
	Physical Form	Aqueous solution of uranyl nitrate	Aqueous solution of uranyl nitrate	Aqueous solution of uranyl nitrate	Aqueous solution of uranyl nitrate	Aqueous solution of uranium oxyfluoride
	Isotopic Composition	93.17 wt% ²³⁵ U	93.17 wt% ²³⁵ U	93.17 wt% ²³⁵ U	93.17 wt% ²³⁵ U	93.18 wt% ²³⁵ U
	Atomic Density (atoms/b-cm)	²³⁵ U: 1.31e-04 to 8.54E-04 ²³⁸ U: 7.46e-06 to 4.86e-05	²³⁵ U: 1.42e-04 to 7.99e-04 ²³⁸ U: 8.11e-06 to 4.55e-05	²³⁵ U: 1.60e-04 to 8.69e-04 ²³⁸ U: 9.14e-6 to 1.03e-05	²³⁵ U: 1.44e-04 to 8.50e-04 ²³⁸ U: 8.20e-6 to 4.84e-05	²³⁵ U: 5.09e-04 to 1.66e-03 ²³⁸ U: 2.88e-5 to 9.41e-05
	Temperature	Room Temp.	Room Temp.	Room Temp.	Room Temp.	Room Temp.
Materials/ Moderator	Element	H	H	H	H	H
	Physical Form	Solution	Solution	Solution	Solution	Solution
	Atomic Density (atoms/b-cm)	5.82e-02 to 6.54e-02	5.88e-02 to 6.53e-02	5.78e-02 to 6.48e-02	5.84e-02 to 6.53e-02	5.96e-02 to 6.44e-02
	Ratio to Fissile Material	86 to 499	74 to 460	65 to 405	69 to 454	35.8 to 126.5
	Temperature	Room Temp.	Room Temp.	Room Temp.	Room Temp.	Room Temp.
Materials/ Reflector	Material/ Physical Form	Unreflected (concrete walls)	Reflected by concrete walls	Concrete	Plexiglas	Water
Materials/ Neutron Absorber	Element	None	None	None	None	None
	Physical Form	N/A	N/A	N/A	N/A	N/A
	Atomic Density (atoms/b-cm)	N/A	N/A	N/A	N/A	N/A
Geometry	Heterogeneity	Homogeneous solution contained in a cylindrical tank	Homogeneous solution contained in a cylindrical tank	Arrays of cylindrical tanks placed in a rectangular geometry	Arrays of cylindrical tanks placed in a rectangular geometry	Homogeneous solution contained in a spherical vessel made of Al.
	Shape	Cylinder	Cylinder	Cylinder	Cylinder	Sphere
Neutron Energy	AENCF ^b	0.0065 to 0.0410 MeV	0.0066 to 0.0375 MeV	0.0071 to 0.0369 MeV	0.0064 to 0.0367 MeV	0.0180 to 0.0450 MeV
	EALF ^b	0.04 to 0.29 eV	0.04 to 0.25 eV	0.046 to 0.27 eV	0.04 to 0.25 eV	0.09 to 0.52 eV
	Neutron Energy Spectra ^a	T: 8.1 to 31.1 % I: 29.1 to 36.5% F: 39.8 to 55.6%	T: 8.7 to 30.4 % I: 29.6 to 36.7% F: 39.9-55.2%	T: 8.3 to 28.7 % I: 30.5 to 37.0 % F: 40.8 to 55.0 %	T: 8.5 to 30.8 % I: 29.1 to 36.3% F: 40.0 to 55.5%	T: 5.8 to 15.4 % I: 34 to 35.7% F: 50.6 to 58.5%
	Fission Rate vs. Neutron Energy ^a	T: 77.5 to 95.5% I: 4.1 to 20.3% F: 0.4 to 2.2%	T: 79.2 to 90.3% I: 4.2 to 18.8% F: 0.4 to 2.0%	T: 78.2 to 95.0% I: 4.6 to 19.7% F: 0.4 to 2.1%	T: 78.9 to 95.5% I: 4.1 to 19.0% F: 0.4 to 2.1%	T: 71.8 to 89.1% I: 9.9 to 25.0 % F: 1.0 to 3.2%

Source: Moscalu 2004, Section 5.1

NOTES: ^a Spectral range defined as follows: thermal (T) [0 to 1 eV], intermediate (I) [1eV to 100 keV], fast (F) [100 keV to 20 MeV].

^b AENCF = average energy of a neutron causing fission, EALF = energy of average lethargy causing fission.

Table XII-5. Range of Applicability of Critical Benchmark Experiments Selected for Comparison with External Configurations Mixtures Highly Enriched in ²³⁵U (Set 3)

Category/ Description	Parameter	Experiment HEU-SOL- THERM-033 (26 cases)	Experiment HEU-SOL- THERM-038 (28 cases) ^b	Experiment HEU-SOL- THERM-042 (8 cases)	Experiment HEU-SOL- THERM-043 (3 case)	Experiment HEU-SOL- THERM-044 (16 cases)
Materials/ Fissionable Material	Fissionable Element	Uranium	Uranium	Uranium	Uranium	Uranium
	Physical Form	Aqueous solution of uranyl nitrate	Aqueous solution of uranyl nitrate	Aqueous solution of uranyl nitrate	Aqueous solution of uranium oxyfluoride	Aqueous solution of uranyl nitrate
	Isotopic Composition	93.2 wt% ²³⁵ U	93.1 wt% ²³⁵ U	92.78 to 93.22 wt% ²³⁵ U	93.2 wt% ²³⁵ U	93.17 wt% ²³⁵ U
	Atomic Density (atoms/b-cm)	²³⁵ U: 8.54e-4 ²³⁸ U: 4.85e-5	²³⁵ U: 9.64e-04 ²³⁸ U: 5.90e-05	²³⁵ U: 3.24e-05 to 4.13e-05 ²³⁸ U: 1.89e-6 to 2.34e-06	²³⁵ U: 4.77e-05 to 3.20e-04 ²³⁸ U: 2.86e-06 to 1.79e-05	²³⁵ U: 8.65e-4 ²³⁸ U: 4.95e-5
	Temperature	Room Temp.	Room Temp.	Room Temp.	Room Temp.	Room Temp.
Materials/ Moderator	Element	H	H	H	H	H
	Physical Form	Solution	Solution	Solution	Solution	Solution
	Atomic Density (atoms/b-cm)	5.81e-02	5.78e-02	6.62e-02 to 6.648e-02	6.53e-2 to 6.67e-2	5.81e-02
	Ratio to Fissile Material	68.1	60.0	1602 to 2050	204 to 1392	67.2
	Temperature	Room Temp.	Room Temp.	Room Temp.	Room Temp.	Room Temp.
Materials/ Reflector	Material/ Physical Form	Concrete	Reflected by various plates (Pb, U, Be, Cd, Polyethylene, Stainless steel, Boraflex, etc) and concrete walls	Unreflected	Unreflected	Concrete
Materials/ Neutron Absorber	Element	B and Cd	B, Cd, Pb, U, Fe, etc	None	None	B, Cl, Cd and Gd
	Physical Form	B and Cd in solution	Absorbers were inserted as plates	N/A	N/A	Absorbers are in various forms (pyrex glass, boraflex rubber, Cd sleeves etc.)
	Atomic Density (atoms/b-cm)	B-10:1.74e-8 Cd: 1.49e-8	Not available	N/A	N/A	B-10:6.99e-03 to 9.57e-4 Cd: 5.19e-03 to 4.63e-02
Geometry	Heterogeneity	Homogeneous solution contained in a nested structure of cylindrical tanks made of stainless steel.	Homogeneous solution contained in two cylindrical tanks	Homogeneous solution contained in a cylindrical tank	Homogeneous solution contained in a spherical vessel made of Al.	Homogeneous solution contained in a nested structure of cylindrical tanks made of stainless steel.
	Shape	Cylinder	Cylinder	Cylinder	Sphere	Cylinder
Neutron Energy	AENCF ^c	0.032 to 0.036 MeV	0.041 to 0.048 MeV	0.0020 to 0.0024 MeV	0.003 to 0.014 MeV	0.0340 to 0.0470 MeV
	EALF ^c	0.269 to 0.316 eV	0.31 to 0.41 eV	0.031 to 0.032 eV	0.033 to 0.075 eV	Not available
	Neutron Energy Spectra ^a	T:8.1 to 8.8 % I: 38.2 to 39 % F:52.6 to 53.4 %	T:5.0 to 26.0 % I: 31.7 to 40.4 % F: 41.5 to 57.7%	T:52.1 to 56.4 % I: 19.6 to 21.3 % F: 24.0 to 26.6 %	T:18.0 to 49.8 % I: 22.2 to 33.7 % F:28.0 to 48.3 %	Not available
	Fission Rate vs. Neutron Energy ^a	T: 76.2 to 78.0 % I: 20.1 to 21.7 % F: 1.9 to 2.1 %	T: 73.8 to 76.9 % I: 20.8 to 23.6 % F: 2.3 to 2.6 %	T: 98.1 to 98.4% I: 1.5 to 1.8% F: 0.1%	T: 90.8 to 97.9 % I: 1.9 to 8.4 % F: 0.1 to 0.8 %	Not available

Source: Moscalu 2004, Section 5.1

NOTES: ^a Spectral range defined as follows: thermal (T) [0 to 1 eV], intermediate (I) [1eV to 100 keV], fast (F) [100 ke to 20 MeV].

^b Spectral data include only selected cases for HEU-SOL-THERM-038 (cases 1 to 28).

^c AENCF = average energy of a neutron causing fission, EALF = energy of average lethargy causing fission.

XII.2.3 Calculation of Lower-Bound Tolerance Limit

The results of the trending parameter analysis for the criticality benchmark subset representative for external configurations containing HEU are presented in Table XII-6. Some of the trending parameters for AENCF (r^2 , T, P-value) from Table XII-6, indicate a slight trend of k_{eff} with AENCF (Moscalu 2004, Section 5.1).

Table XII-6. Trending Parameter Results for the Criticality Benchmark Subset Representative for Configurations Containing HEU External to the Waste Package

Trend Parameter	n	Intercept	Slope	r^2	T	$t_{0.025,n-2}$	P-value	Goodness-of-Fit Tests	Valid Trend
AENCF	187	1.0055	-0.019	0.4264	-11.73	1.980 ^a	4.2E-24	Passed	Yes

Source: Moscalu 2004, Section 5.1

NOTES: ^aTable A-4 from Natrella (1963) has a limited number of entries for n (t=1.98 for n=120 and t=1.96 for n close to infinity); using t=1.98 is conservative for the current application where n=187.

^bAENCF = average energy of a neutron causing fission, EALF = energy of average lethargy causing fission.

Figure XII-1 presents the k_{eff} values and the calculated lower bound tolerance limit for this set of benchmark experiments. The lower bound tolerance limit can be also written as (Moscalu 2004, Section 5.1):

$$\text{Lower Bound Tolerance Limit} = 0.970611 \text{ for } 0 \text{ MeV} < \text{AENCF} < 0.247 \text{ MeV}$$

$$\text{Lower Bound Tolerance Limit} = -1.7411e-02 * \text{AENCF} + 0.97491 \text{ for } 0.247 \text{ MeV} \leq \text{AENCF} < 0.902 \text{ MeV}$$

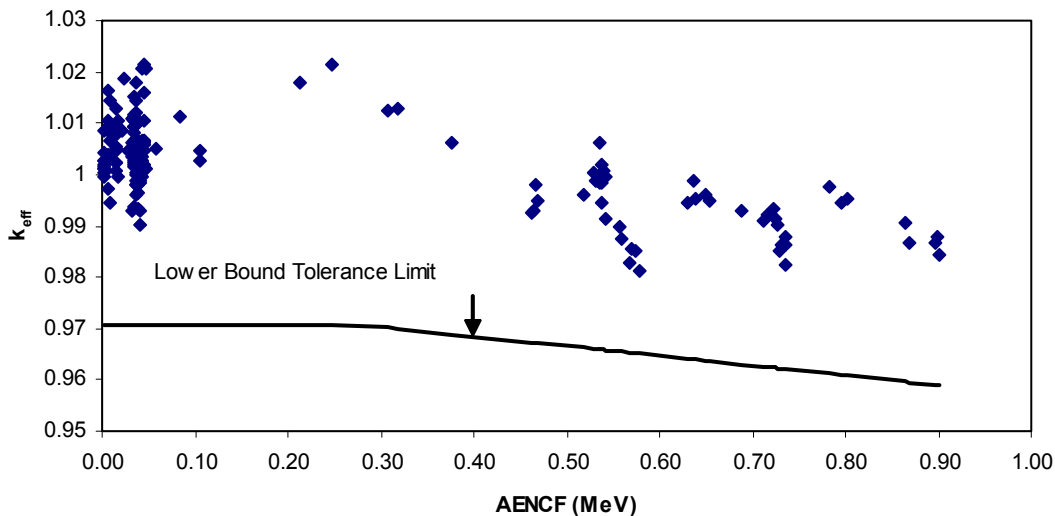

NOTE: AENCF = average energy of a neutron causing fission.

Figure XII-1. Lower-Bound Tolerance Limit Applicable for Configurations Containing HEU External to the Waste Package

XII.3 IEU SYSTEMS

Selection of the criticality benchmark experiments for IEU systems, determination of the range of applicability of the selected benchmarks, and the calculation of the LBTL are discussed in the following three sections.

XII.3.1 Selection of the Criticality Benchmark Experiments

The criticality experiments selected for inclusion in the benchmarking of the criticality computational method must be representative of the types of materials, conditions, and parameters to be represented. A sufficient number of experiments with varying experimental parameters should be selected for inclusion in the benchmarking to ensure as wide an area of applicability as feasible and statistically significant results. While there is no absolute guideline for the minimum number of critical experiments necessary to benchmark a computational method, the use of only a few (i.e., less than 10) experiments should be accompanied by a suitable technical basis supporting the rationale for acceptability of the results (Dean and Tayloe 2001, p. 5).

For the present application (configurations with mixtures of IEU fissile material external to the waste package), the criticality benchmark experiments have been selected based on their fissile content, moderator and geometry. The benchmark experiments are from the *International Handbook of Evaluated Criticality Safety Benchmark Experiments* (NEA 2003) unless otherwise noted. The set of criticality benchmark experiments has been constructed to accommodate large variations in the range of parameters of the configurations and also to provide adequate statistics for the LBTL calculations.

The selected benchmark experiments containing a total of 109 individual cases are presented in Table XII-7 along with the results of the MCNP code calculations. All cases have been run using the isotopic libraries described in Table 2 (Section 4.2.2).

Table XII-7. k_{eff} Values for Benchmarks Applicable to Intact Moderated Configurations Containing Intermediate Enrichment Uranium Mixtures

Experiment	Case Name	Benchmark Values		Calculated Values (MCNP)		
		k_{eff}	σ_{exp}	k_{eff}	σ_{calc}	AENCF
Experiment IEU-COMP-THERM-001 (29 cases)	iect101	1.0000	0.004	0.9974	0.0009	0.21679
	iect102	1.0000	0.004	0.9960	0.0009	0.15817
	iect103	1.0000	0.004	0.9931	0.0010	0.10412
	iect104	1.0000	0.004	0.9974	0.0011	0.07405
	iect105	1.0000	0.004	1.0085	0.0009	0.04552
	iect106	1.0000	0.004	1.0003	0.0010	0.10793
	iect107	1.0000	0.004	0.9980	0.0010	0.11064
	iect108	1.0000	0.004	0.9960	0.0010	0.11867
	iect109	1.0000	0.004	1.0004	0.0008	0.1679
	iect110	1.0000	0.004	0.9967	0.0010	0.15756
	iect111	1.0000	0.004	0.9958	0.0010	0.15732
	iect112	1.0000	0.004	0.9964	0.0010	0.15568
	iect113	1.0000	0.004	0.9967	0.0010	0.0743

Table XII-7. k_{eff} Values for Benchmarks Applicable to Intact Moderated Configurations Containing Intermediate Enrichment Uranium Mixtures (Continued)

Experiment	Case Name	Benchmark Values		Calculated Values (MCNP)		
		k_{eff}	σ_{exp}	k_{eff}	σ_{calc}	AENCF
Experiment IEU-COMP-THERM-001 (29 cases) (continued)	iect114	1.0000	0.004	0.9979	0.0009	0.07375
	iect115	1.0000	0.004	0.9981	0.0010	0.074
	iect116	1.0000	0.004	1.0021	0.0009	0.05547
	iect117	1.0000	0.004	0.9965	0.0010	0.20814
	iect118	1.0000	0.004	0.9976	0.0011	0.13428
	iect119	1.0000	0.004	1.0045	0.0010	0.06114
	iect120	1.0000	0.004	1.0005	0.0009	0.15539
	iect121	1.0000	0.004	0.9988	0.0009	0.21334
	iect122	1.0000	0.004	0.9990	0.0011	0.19772
	iect123	1.0000	0.004	0.9952	0.0011	0.12826
	iect124a	1.0000	0.004	1.0004	0.0011	0.13305
	iect125	1.0000	0.004	0.9987	0.0009	0.05992
	iect126	1.0000	0.004	1.0044	0.0010	0.05663
	iect127	1.0000	0.004	1.0032	0.0009	0.05633
	iect128	1.0000	0.004	1.0051	0.0009	0.15824
iect129	1.0000	0.004	1.0012	0.0010	0.15184	
Experiment IEU-COMP-THERM-005 (2 cases)	case2	0.980	0.003	0.9807	0.0004	0.48226
	case3	1.014	0.006	1.0158	0.0005	0.25976
Experiment LEU-SOL-THERM-003 (9 cases)	lst3-1	0.9997	0.0039	0.9993	0.0004	0.0186
	lst3-2	0.9993	0.0042	0.9971	0.00038	0.0166
	lst3-3	0.9995	0.0042	1.0015	0.00037	0.0164
	lst3-4	0.9995	0.0042	0.9954	0.00038	0.0162
	lst3-5	0.9997	0.0048	0.9990	0.00031	0.0133
	lst3-6	0.9999	0.0049	0.9992	0.0003	0.0129
	lst3-7	0.9994	0.0049	0.9972	0.0003	0.0127
	lst3-8	0.9993	0.0052	1.0008	0.00025	0.0114
	lst3-9	0.9996	0.0052	0.9973	0.00025	0.0114
Experiment LEU-SOL-THERM-004 (7 cases)	lst4_1	0.9994	0.0008	1.0029	0.0007	0.0188
	lst4_29	0.9999	0.0009	1.0034	0.0006	0.0179
	lst4_33	0.9999	0.0009	1.0013	0.0007	0.017
	lst4_34	0.9999	0.001	1.0037	0.0006	0.0157
	lst4_46	0.9999	0.001	1.0032	0.0006	0.0154
	lst4_51	0.9994	0.0011	1.0023	0.0005	0.0148
	lst4_54	0.9996	0.0011	1.0026	0.0005	0.0142
Experiment LEU-SOL-THERM-007 (5 cases)	leust7_1	0.9961	0.0009	0.9966	0.0002	0.02
	leust7_2	0.9973	0.0009	0.9995	0.0002	0.0187
	leust7_3	0.9985	0.001	0.9979	0.0002	0.0173
	leust7_4	0.9988	0.0011	1.0005	0.0002	0.0166
	leust7_5	0.9983	0.0011	0.9989	0.0002	0.0159
Experiment LEU-SOL-THERM-008 (4 cases)	lst8_72	0.9999	0.0014	1.0038	0.0002	0.0152
	lst8_74	1.0002	0.0015	1.0023	0.0002	0.0154
	lst8_76	0.9999	0.0014	1.0028	0.0002	0.0153
	lst8_78	0.9999	0.0014	1.0040	0.0002	0.0153

Table XII-7. k_{eff} Values for Benchmarks Applicable to Intact Moderated Configurations Containing Intermediate Enrichment Uranium Mixtures (Continued)

Experiment	Case Name	Benchmark Values		Calculated Values (MCNP)		
		k_{eff}	σ_{exp}	k_{eff}	σ_{calc}	AENCF
Experiment LEU-SOL-THERM-009 (3 cases)	lst9_92	0.9998	0.0014	1.0018	0.0005	0.0155
	lst9_93	0.9999	0.0014	1.0021	0.0002	0.0157
	lst9_94	0.9999	0.0014	1.0022	0.0002	0.0158
Experiment LEU-SOL-THERM-010 (4 cases)	lst10_83	0.9999	0.0153	1.0023	0.0003	0.0153
	lst10_85	0.9999	0.0154	1.0019	0.0003	0.0154
	lst10_86	1.0000	0.0153	1.0032	0.0003	0.0153
	lst10_88	1.0001	0.0154	1.0026	0.0003	0.0154
Experiment LEU-SOL-THERM-016 (7 cases)	lst16_05	0.9996	0.0013	1.0093	0.0007	0.0267
	lst16_13	0.9999	0.0013	1.0080	0.0006	0.0248
	lst16_25	0.9994	0.0014	1.0075	0.0006	0.0216
	lst16_29	0.9996	0.0014	1.0068	0.0006	0.0209
	lst16_31	0.9995	0.0014	1.0059	0.0005	0.0195
	lst16_40	0.9992	0.0015	1.0043	0.0005	0.0186
	lst16_96	0.9994	0.0015	1.0047	0.0005	0.018
Experiment LEU-SOL-THERM-017 (6 cases)	lst17_04	0.9981	0.0013	1.0051	0.0007	0.0275
	lst17_22	0.9986	0.0013	1.0049	0.0006	0.0258
	lst17_23	0.9989	0.0014	1.0052	0.0006	0.0224
	lst17_26	0.9992	0.0014	1.0043	0.0006	0.0212
	lst17_30	0.9987	0.0015	1.0043	0.0005	0.02
Experiment LEU-SOL-THERM-018 (6 cases)	lst17_47	0.9996	0.0015	1.0042	0.0006	0.0192
	RUN133	0.9992	0.001	1.0033	0.0002	0.0183
	RUN142	0.9996	0.001	1.0042	0.0003	0.0187
	RUN143	0.9996	0.001	1.0045	0.0003	0.0188
	RUN144	0.9997	0.001	1.0033	0.0003	0.0187
	RUN145	0.9992	0.001	1.0038	0.0003	0.0187
Experiment LEU-SOL-THERM-019 (6 cases)	RUN146	0.9996	0.001	1.0037	0.0003	0.0186
	RUN149	0.9997	0.0009	1.0043	0.0003	0.019
	RUN150	0.9995	0.0009	1.0043	0.0003	0.019
	RUN151	0.9999	0.0009	1.0049	0.0002	0.0191
	RUN152	0.9996	0.0009	1.0054	0.0003	0.0191
	RUN153	0.9998	0.0009	1.0050	0.0003	0.0191
Experiment LEU-SOL-THERM-020 (4 cases)	RUN183	0.9994	0.0009	1.0036	0.0003	0.0189
	LST20C1	0.9995	0.001	1.0014	0.0003	0.015
	LST20C2	0.9996	0.001	1.0000	0.0003	0.0143
	LST20C3	0.9997	0.0012	0.9993	0.0003	0.0131
Experiment LEU-SOL-THERM-021 (4 cases)	LST20C4	0.9998	0.0012	1.0004	0.0003	0.0125
	LST21C1	0.9983	0.0009	0.9991	0.0003	0.0154
	LST21C2	0.9985	0.001	0.9996	0.0003	0.0144
	LST21C3	0.9989	0.0011	0.9976	0.0003	0.0135
Experiment LEU-SOL-THERM-022 (4 cases)	LST21C4	0.9993	0.0012	0.9999	0.0003	0.0127
	case1	0.9999	0.0010	1.0049	0.0002	0.0185
	case2	0.9994	0.0010	1.0058	0.0002	0.0184
	case3	0.9993	0.0010	1.0055	0.0002	0.0185
	case4	0.9994	0.0010	1.0050	0.0002	0.0186

Table XII-7. k_{eff} Values for Benchmarks Applicable to Intact Moderated Configurations Containing Intermediate Enrichment Uranium Mixtures (Continued)

Experiment	Case Name	Benchmark Values		Calculated Values (MCNP)		
		k_{eff}	σ_{exp}	k_{eff}	σ_{calc}	AENCF
Experiment LEU-SOL-THERM-023 (9 cases)	261	0.9963	0.0009	1.0000	0.0005	0.0175
	274	0.9967	0.0009	0.9950	0.0005	0.0177
	273	0.9967	0.0009	1.0000	0.0005	0.0179
	262	0.9960	0.0009	0.9986	0.0005	0.0177
	263	0.9959	0.0009	0.9990	0.0005	0.0176
	264	0.9959	0.0009	0.9992	0.0005	0.0175
	267	0.9966	0.0009	0.9993	0.0005	0.0177
	268	0.9970	0.0009	0.9996	0.0005	0.0177
	269	0.9977	0.0009	0.9997	0.0005	0.0178

Source: Moscalu 2004, Section 5.2

The experiments listed in Table XII-6 cover configuration classes NF-1 through NF-5 and FF-1 through FF-3 for configurations containing mixtures of intermediate enriched uranium external to the waste package.

XII.3.2 Range of Applicability of Selected Critical Benchmark Experiments

Tables XII-8 through XII-11 summarize the range of applicability of the experiments listed in Table XII-7. The information is excerpted from Moscalu (2004, Section 5.2).

Table XII-8. Range of Applicability of Critical Benchmark Experiments Selected for Comparison with External Configurations Containing IEU Mixtures (Set 1)

Category/ Description	Parameter	Experiment IEU-COMP- THERM-001 (29 cases)	Experiment IEU-COMP- THERM-005 (2 cases)	Experiment LEU-SOL- THERM-003 (9 cases)	Experiment LEU-SOL- THERM-004 (7 cases)
Materials/ Fissionable Material	Fissionable Element	Uranium	Uranium	Uranium	Uranium
	Physical Form	UF ₄ compound with polytetra- fluoroethylene	Mixture of UO ₂ and Th metal	Aqueous solution of uranyl nitrate	Aqueous solution of uranyl nitrate
	Isotopic Composition	29.83 wt% ²³⁵ U	90 wt% and 36 wt% ²³⁵ U	10 wt% ²³⁵ U	9.97 wt% ²³⁵ U
	Atomic Density (atoms/b-cm)	²³⁵ U: 2.37e-03 ²³⁸ U: 5.50e-03	²³⁵ U: 5.39e-03 and 1.35E-02 ²³⁸ U: 1.47e-03 and 9.53e-03	²³⁵ U: 4.34e-05 to 7.64e-05 ²³⁸ U: 3.82e-04 to 6.73e-04	²³⁵ U: 5.76e-05 to 7.92e-05 ²³⁸ U: 5.13e-04 to 7.06e-04
	Temperature	Room temp.	Room temp.	Room temp.	Room temp.
Materials/ Moderator	Element	H; C	H; C	H	H
	Physical Form	Polyethylene	Polyethylene	Solution	Solution
	Atomic Density (atoms/b-cm)	H: 7.52e-02 C: 3.92e-02	H: 7.2588-e02 C: 3.6294e-02	5.89e-02 to 6.23e- 02	5.70e-02 to 5.86e- 02
	Ratio to Fissile Material	H/ ²³⁵ U = 4 to 222	H/ ²³⁵ U = 0 to 10	770 to 1437	719 to 1018
	Temperature	Room temp.	Room temp.	Room temp.	Room temp.
Materials/ Reflector	Material/ Physical Form	Unreflected or reflected by paraffin	K _{inf} experimental set-up	Unreflected	Reflected by water
Materials/ Neutron Absorber	Element	B or Cd for some experiments	None	None	None
	Physical Form	Metallic sheets	N/A	N/A	N/A
	Atomic Density (atoms/b-cm)	Cd: 4.64e-02 ¹⁰ B: 3.21e-03	N/A	N/A	N/A
Geometry	Heterogeneity	Heterogeneous small cubes of fissile compound interspersed with moderator cubes	Heterogeneous set of stainless steel tubes forming a hexagonal infinite lattice	Homogeneous solution in a spherical tank	Homogeneous solution in a cylindrical tank
	Shape	Cuboid	Cylinder	Sphere	Cylinder
Neutron Energy	AENCF ^b	0.0455 to 0.2168 MeV	0.260 and 0.483 MeV	0.0114 to 0.0186 MeV	0.0142 to 0.0188 MeV
	EALF ^b	0.11 to 9.09 eV	1e+02 and 2.97e+04 eV	3.46e-02 to 4.14e- 02 eV	3.75e-02 to 4.21e- 02 eV
	Neutron Energy Spectra ^a	T: 1.8 to 22.8% I: 24.9 to 40.2% F: 49.6 to 63%	T: 0 and 1.0% I: 35.0 and 43.0% F: 56.0 and 65.0%	T: 37.6 to 49.1 % I: 22.7 to 27.3% F: 28.2 to 35.1%	T: 36.8 to 43.1 % I: 25.3 to 27.8% F: 31.6 to 35.4%
	Fission Rate vs. Neutron Energy ^a	T: 49.9 to 90.9% I: 7.1 to 42.8% F: 2.0 to 11.1%	T: 0.2 and 21.4% I: 56.5 and 63.6% F: 15 and 43.2%	T: 96.2 to 97.6% I: 2 to 3.1% F: 0.4 to 0.7%	T: 96.1 to 97.0% I: 2.5 to 3.2% F: 0.5 to 0.7%

Source: Moscalu 2004, Section 5.2

NOTES: ^a Spectral range defined as follows: thermal (T) [0 to 1 eV], intermediate (I) [1eV to 100 keV], fast (F) [100 keV to 20 MeV].

^b AENCF = average energy of a neutron causing fission, EALF = energy of average lethargy causing fission.

Table XII-9. Range of Applicability of Critical Benchmark Experiments Selected for Comparison with External Configurations Containing IEU Mixtures (Set 2)

Category/Description	Parameter	Experiment LEU-SOL-THERM-007 (5 cases)	Experiment LEU-SOL-THERM-008 (4 cases)	Experiment LEU-SOL-THERM-009 (3 cases)	Experiment LEU-SOL-THERM-010 (4 cases)
Materials/ Fissionable Material	Fissionable Element	Uranium	Uranium	Uranium	Uranium
	Physical Form	Aqueous solution of uranyl nitrate	Aqueous solution of uranyl nitrate	Aqueous solution of uranyl nitrate	Aqueous solution of uranyl nitrate
	Isotopic Composition	9.97 wt% ²³⁵ U	9.97 wt% ²³⁵ U	9.97 wt% ²³⁵ U	9.97 wt% ²³⁵ U
	Atomic Density (atoms/b-cm)	²³⁵ U: 6.18e-05 to 8.00e-05 ²³⁸ U: 5.5e-04 to 7.12e-04	²³⁵ U: 6.14e-05 ²³⁸ U: 5.47e-04	²³⁵ U: 6.26e-05 ²³⁸ U: 5.57e-04	²³⁵ U: 6.18e-05 to 6.21e-05 ²³⁸ U: 5.51e-04 to 5.53e-04
	Temperature	Room temp.	Room temp.	Room temp.	Room temp.
Materials/ Moderator	Element	H	H	H	H
	Physical Form	Solution	Solution	Solution	Solution
	Atomic Density (atoms/b-cm)	5.67e-02 to 5.82e-02	5.86e-02	5.85e-02	5.85e-02
	Ratio to Fissile Material	709 to 942	951 to 956	934 to 936	942 to 946
	Temperature	Room temp.	Room temp.	Room temp.	Room temp.
Materials/ Reflector	Material/ Physical Form	Unreflected	Reflected by concrete	Reflected by borated concrete	Reflected by polyethylene
Materials/ Neutron Absorber	Element	None	None	None	None
	Physical Form	N/A	N/A	N/A	N/A
	Atomic Density (atoms/b-cm)	N/A	N/A	N/A	N/A
Geometry	Heterogeneity	Homogeneous solution contained in a cylindrical tank	Homogeneous solution contained in a cylindrical tank	Homogeneous solution contained in a cylindrical tank	Homogeneous solution contained in a cylindrical tank
	Shape	Cylinder	Cylinder	Cylinder	Cylinder
Neutron Energy	AENCF ^b	0.0159 to 0.0200 MeV	0.0152 to 0.0154 MeV	0.0155 to 0.0158 MeV	0.0153 to 0.0154 MeV
	EALF ^b	3.87e-02 to 4.28e-02 eV	3.84e-02 eV	3.89e-02 eV	3.84e-02 eV
	Neutron Energy Spectra ^a	T: 35.9 to 41.1 % I: 26 to 28.1% F: 32.9 to 36%	T: 41.5 to 41.7% I: 25.9 to 26% F: 32.4 to 35%	T: 40.8 to 41 % I: 26.2 to 26.3% F: 32.8 to 32.9%	T: 41.6 % I: 25.8 to 25.9% F: 32.5 to 32.6%
	Fission Rate vs. Neutron Energy ^a	T: 95.9 to 96.7% I: 2.7 to 3.4% F: 0.6 to 0.7%	T: 96.8% I: 2.6% F: 0.6%	T: 96.7% I: 2.7% F: 0.6%	T: 96.8% I: 2.6% F: 0.6%

Source: Moscalu 2004, Section 5.2

NOTES: ^a Spectral range defined as follows: thermal (T) [0 to 1 eV], intermediate (I) [1eV to 100 keV], fast (F) [100 keV to 20 MeV].

^b AENCF = average energy of a neutron causing fission, EALF = energy of average lethargy causing fission.

Table XII-10. Range of Applicability of Critical Benchmark Experiments Selected for Comparison with Homogeneous Moderated Configurations of IEU (Set 3)

Category/Description	Parameter	Experiment LEU-SOL-THERM-016 (7 cases)	Experiment LEU-SOL-THERM-017 (6 cases)	Experiment LEU-SOL-THERM-018 (6 cases)	Experiment LEU-SOL-THERM-019 (6 cases)
Materials/ Fissionable Material	Fissionable Element	Uranium	Uranium	Uranium	Uranium
	Physical Form	Aqueous solution of uranyl nitrate	Aqueous solution of uranyl nitrate	Aqueous solution of uranyl nitrate	Aqueous solution of uranyl nitrate
	Isotopic Composition	9.97 wt% ²³⁵ U	9.97 wt% ²³⁵ U	9.97 wt% ²³⁵ U	9.97 wt% ²³⁵ U
	Atomic Density (atoms/b-cm)	²³⁵ U: 7.65e-5 to 1.19e-04 ²³⁸ U: 6.82e-04 to 1.06e-03	²³⁵ U: 8.05e-05 to 1.19e-04 ²³⁸ U: 7.17e-04 to 1.06e-03	²³⁵ U: 7.87e-5 to 8.04e-05 ²³⁸ U: 7.01e-04 to 7.16e-04	²³⁵ U: 8.07e-05 to 8.13e-05 ²³⁸ U: 7.19e-04 to 7.24e-04
	Temperature	Room temp.	Room temp.	Room temp.	Room temp.
Materials/ Moderator	Element	H	H	H	H
	Physical Form	Solution	Solution	Solution	Solution
	Atomic Density (atoms/b-cm)	5.56e-02 to 5.91e-02	5.56e-02 to 5.87e-02	5.87e-02 to 5.91e-02	5.87e-02
	Ratio to Fissile Material	469 to 772	469 to 729	731 to 751	721 to 728
	Temperature	Room temp.	Room temp.	Room temp.	Room temp.
Materials/ Reflector	Material/ Physical Form	Reflected by water	Unreflected	Reflected by concrete	Reflected by polyethylene
Materials/ Neutron Absorber	Element	None	None	None	None
	Physical Form	N/A	N/A	N/A	N/A
	Atomic Density (atoms/b-cm)	N/A	N/A	N/A	N/A
Geometry	Heterogeneity	Homogeneous solution in a rectangular slab tank	Homogeneous solution in a rectangular slab tank	Homogeneous solution in a rectangular slab tank	Homogeneous solution in a rectangular slab tank
	Shape	Rectangular slab	Rectangular slab	Rectangular slab	Rectangular slab
Neutron Energy	AENCF ^b	0.0180 to 0.0267 MeV	0.0192 to 0.0275 MeV	0.0183 to 0.0188 MeV	0.0189 to 0.0191 MeV
	EALF ^b	4.15e-02 to 5.22e-02 eV	4.24e-02 to 5.23e-02 eV	0.042 to 0.0425 eV	0.0425 to 0.0426 eV
	Neutron Energy Spectra ^a	T: 29.1 to 37.7 % I: 27.7 to 31.2% F: 34.7 to 39.7%	T: 28.9 to 36.5 % I: 28 to 31.1% F: 35.5 to 40.0%	T: 36.5 to 37 % I: 28 to 28.3 % F: 34.9 to 35.2%	T: 36.4 to 36.5 % I: 28.1 to 28.2 % F: 35.4 %
	Fission Rate vs. Neutron Energy ^a	T: 94.3 to 96.2% I: 3.2 to 4.6% F: 0.7 to 1.0%	T: 94.3 to 96.0% I: 3.3 to 4.6% F: 0.7 to 1.0%	T: 96 to 96.1% I: 3.3 % F: 0.7 %	T: 95.9 to 96.0% I: 3.3 % F: 0.7 %

Source: Moscalu 2004, Section 5.2

NOTES: ^a Spectral range defined as follows: thermal (T) [0 to 1 eV], intermediate (I) [1eV to 100 keV], fast (F) [100 keV to 20 MeV].

^b AENCF = average energy of a neutron causing fission, EALF = energy of average lethargy causing fission.

Table XII-11. Range of Applicability of Critical Benchmark Experiments Selected for Comparison with Homogeneous Moderated Configurations of IEU (Set 4)

Category/Description	Parameter	Experiment LEU-SOL-THERM-020 (4 cases)	Experiment LEU-SOL-THERM-021 (4 cases)	Experiment LEU-SOL-THERM-022 (4 cases)	Experiment LEU-SOL-THERM-023 (9 cases)
Materials/ Fissionable Material	Fissionable Element	Uranium	Uranium	Uranium	Uranium
	Physical Form	Aqueous solution of uranyl nitrate	Aqueous solution of uranyl nitrate	Aqueous solution of uranyl nitrate	Aqueous solution of uranyl nitrate
	Isotopic Composition	9.97 wt% ²³⁵ U	9.97 wt% ²³⁵ U	9.97 wt% ²³⁵ U	9.97 wt% ²³⁵ U
	Atomic Density (atoms/b-cm)	²³⁵ U: 4.95e-05 to 6.21e-05 ²³⁸ U: 4.41e-04 to 5.53e-04	²³⁵ U: 4.95e-5 to 6.21e-05 ²³⁸ U: 4.41e-04 to 5.53e-04	²³⁵ U: 7.88e-05 to 7.93e-05 ²³⁸ U: 7.03e-04 to 7.07e-04	²³⁵ U: 7.42e-5 to 7.56e-05 ²³⁸ U: 6.61e-04 to 6.73e-04
	Temperature	Room Temp.	Room Temp.	Room Temp.	Room Temp.
Materials/ Moderator	Element	H	H	H	H
	Physical Form	Solution	Solution	Solution	Solution
	Atomic Density (atoms/b-cm)	6.03e-02 to 6.13e-02	6.03e-02 to 6.13e-02	5.90e-02 to 5.91e-02	5.93e-02 to 5.95e-02
	Ratio to Fissile Material	971 to 1239	971 to 1239	744 to 750	785 to 803
	Temperature	Room Temp.	Room Temp.	Room Temp.	Room Temp.
Materials/ Reflector	Material/ Physical Form	Reflected by water	Unreflected	Reflected by borated concrete	Unreflected
Materials/ Neutron Absorber	Element	None	None	None	None
	Physical Form	N/A	N/A	N/A	N/A
	Atomic Density (atoms/b-cm)	N/A	N/A	N/A	N/A
Geometry	Heterogeneity	Homogeneous solution in a cylindrical tank	Homogeneous solution in a cylindrical tank	Homogeneous solution in a rectangular slab tank	Homogeneous solution in a rectangular slab tank
	Shape	Cylinder	Cylinder	Rectangular slab	Rectangular slab
Neutron Energy	AENCF ^b	0.0125 to 0.0150 MeV	0.0127 to 0.0154 MeV	0.0184 to 0.0186 MeV	0.0175 to 0.0179 MeV
	EALF ^b	3.57e-02 to 3.81e-02	3.58e-02 to 3.83e-02	4.21e-02 to 4.22e-02	Not available
	Neutron Energy Spectra ^a	T: 42.2 to 46.6 % I: 23.8 to 25.6 % F: 29.6 to 32.2 %	T: 41.8 to 46.3 % I: 23.9 to 25.7 % F: 29.8 to 32.5 %	T: 36.8 to 36.9 % I: 28.1 % F: 35.0 to 35.1 %	Not available
	Fission Rate vs. Neutron Energy ^a	T: 96.8 to 97.3 % I: 2.2 to 2.6 % F: 0.5 to 0.6 %	T: 96.8 to 97.3 % I: 2.2 to 2.6 % F: 0.5 to 0.6 %	T: 96.0 to 96.1 % I: 3.3 % F: 0.7 %	Not available

Source: Moscalu 2004, Section 5.2

NOTES: ^a Spectral range defined as follows: thermal (T) [0 to 1 eV], intermediate (I) [1eV to 100 keV], fast (F) [100 keV to 20 MeV].

^b AENCF = average energy of a neutron causing fission, EALF = energy of average lethargy causing fission.

XII.3.3 Calculation of Lower-Bound Tolerance Limit

The results of the trending parameter analysis for the criticality benchmark subset representative for external configurations containing HEU are presented in Table XIII-6 (Moscalu 2004, Section 5.2.3).

Table XII-12. Trending Parameter Results for the Criticality Benchmark Experiments Representative for Configurations Containing IEU External to the Waste Package

Trend Parameter	n	Intercept	Slope	r ²	T	t _{0.025,n-2}	P-value	Goodness-of-Fit Tests	Valid Trend
AENCF ^b	109	1.0030	-0.0194	0.1708	-4.6939	1.984 ^a	7.98e-06	Passed	Yes

Source: Moscalu 2004, Attachment II

NOTES: ^aValue interpolated from Table A-4 of Natrella 1963.

^bAENCF = average energy of a neutron causing fission.

The trending parameters for AENCF (r², T, P-value) from Table XII-11 indicate a trend of k_{eff} with AENCF.(Moscalu 2004, Section 5.2). The LBTL is calculated for this situation using the CLREG code (BSC 2001c).

Figure XII-2 presents the k_{eff} values and the LBTL calculated with CLREG code. The LBTL can be also written as (Moscalu 2004, Section 5.2):

$$\text{Lower Bound Tolerance Limit} = 0.97841 \text{ for } 0 \text{ MeV} < \text{AENCF} < 0.1518 \text{ MeV}$$

$$\text{Lower Bound Tolerance Limit} = -1.9322\text{e-}02 * \text{AENCF} + 0.981339 \text{ for } 0.1518 \text{ MeV} \leq \text{AENCF} < 0.482 \text{ MeV}$$

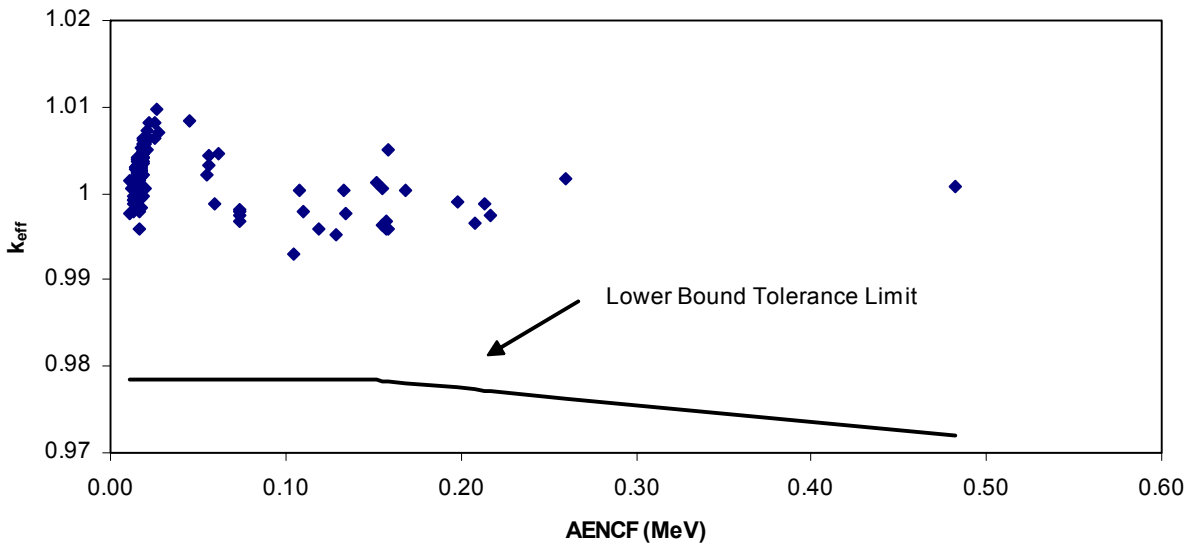

NOTE: AENCF = average energy of a neutron causing fission.

Figure XII-2. Lower Bound Tolerance Limit Applicable for Configurations Containing IEU Mixtures External to the Waste Package

XII.4 LEU SYSTEMS

Selection of the criticality benchmark experiments for LEU systems, determination of the range of applicability of the selected benchmarks, and the calculation of the LBTL are discussed in the following three sections.

XII.4.1 Selection of the Criticality Benchmark Experiments

The criticality experiments selected for inclusion in the benchmarking of the criticality computational method must be representative of the types of materials, conditions, and parameters to be represented. A sufficient number of experiments with varying experimental parameters should be selected for inclusion in the benchmarking to ensure as wide an area of applicability as feasible and statistically significant results. While there is no absolute guideline for the minimum number of critical experiments necessary to benchmark a computational method, the use of only a few (i.e., less than 10) experiments should be accompanied by a suitable technical basis supporting the rationale for acceptability of the results (Dean and Tayloe 2001, p. 5).

For the present application (configurations with mixtures of LEU fissile material external to the waste package), the criticality benchmark experiments have been selected based on their fissile content, moderator and geometry. The benchmark experiments are from the *International Handbook of Evaluated Criticality Safety Benchmark Experiments* (NEA 2003) unless otherwise noted. The set of criticality benchmark experiments has been constructed to accommodate large variations in the range of parameters of the configurations and also to provide adequate statistics for the LBTL calculations.

The selected benchmark experiments containing a total of 96 individual cases are presented in Table XII-13 along with the results of the MCNP code calculations. All cases have been run using the isotopic libraries described in Table 2 (Section 4.2.2).

Table XII-13. Critical Benchmarks Selected for Validation of the Criticality Model for External Configurations Containing Mixtures with Low Enriched Uranium

Experiment	Case Name	Benchmark Values		Calculated Values (MCNP)		
		k_{eff}	σ_{exp}	k_{eff}	σ_{calc}	AENCF
Experiment LEU-COMP-THERM-033 (52 cases)	case1	1.0000	0.0038	0.9945	0.0007	0.1791
	case2	1.0000	0.0038	0.9959	0.0006	0.1792
	case3	1.0000	0.0038	0.9965	0.0007	0.1789
	case4	1.0000	0.0038	0.9957	0.0006	0.1793
	case5	1.0000	0.0039	0.9993	0.0006	0.1379
	case6	1.0000	0.0039	1.0002	0.0007	0.1376
	case7	1.0000	0.0039	0.9983	0.0006	0.1371
	case8	1.0000	0.0040	0.9971	0.0006	0.1114
	case9	1.0000	0.0040	0.9957	0.0006	0.1119
	case10	1.0000	0.0039	0.9970	0.0007	0.0973
	case11	1.0000	0.0039	0.9963	0.0006	0.0972
	case12	1.0000	0.0039	0.9963	0.0006	0.0973
	case13	1.0000	0.0041	0.9973	0.0006	0.0840
	case14	1.0000	0.0051	0.9905	0.0005	0.0619
	case15	1.0000	0.0051	0.9915	0.0005	0.0623
	case16	1.0000	0.0051	0.9917	0.0005	0.0617
	case17	1.0000	0.0038	1.0048	0.0007	0.1657
	case18	1.0000	0.0038	1.0052	0.0007	0.1665

Table XII-13. Critical Benchmarks Selected for Validation of the Criticality Model for External Configurations Containing Mixtures with Low Enriched Uranium (Continued)

Experiment	Case Name	Benchmark Values		Calculated Values (MCNP)		
		k_{eff}	σ_{exp}	k_{eff}	σ_{calc}	AENCF
Experiment LEU-COMP-THERM-033 (52 cases) (continued)	case19	1.0000	0.0038	1.0058	0.0007	0.1657
	case20	1.0000	0.0038	1.0041	0.0007	0.1657
	case21	1.0000	0.0038	1.0061	0.0007	0.1650
	case22	1.0000	0.0039	1.0078	0.0007	0.1015
	case23	1.0000	0.0040	0.9946	0.0007	0.1952
	case24	1.0000	0.0040	0.9949	0.0007	0.1945
	case25	1.0000	0.0040	0.9950	0.0007	0.1953
	case26	1.0000	0.0039	0.9985	0.0007	0.1503
	case27	1.0000	0.0039	0.9992	0.0007	0.1503
	case28	1.0000	0.0039	0.9973	0.0007	0.1502
	case29	1.0000	0.0039	0.9993	0.0007	0.1503
	case30	1.0000	0.0039	0.9970	0.0007	0.1204
	case31	1.0000	0.0039	0.9981	0.0007	0.1199
	case32	1.0000	0.0039	0.9973	0.0006	0.1208
	case33	1.0000	0.0039	0.9955	0.0007	0.1209
	case34	1.0000	0.0039	0.9960	0.0007	0.1205
	case35	1.0000	0.0040	0.9965	0.0006	0.1047
	case36	1.0000	0.0040	0.9963	0.0006	0.1049
	case37	1.0000	0.0040	0.9950	0.0007	0.1047
	case38	1.0000	0.0040	0.9964	0.0006	0.1044
	case39	1.0000	0.0040	0.9964	0.0006	0.1047
	case40	1.0000	0.0040	0.9954	0.0006	0.1049
	case41	1.0000	0.0041	0.9965	0.0006	0.0901
	case42	1.0000	0.0041	0.9955	0.0006	0.0896
	case43	1.0000	0.0041	0.9946	0.0006	0.0890
	case44	1.0000	0.0050	0.9913	0.0005	0.0645
	case45	1.0000	0.0050	0.9908	0.0005	0.0637
	case46	1.0000	0.0050	0.9893	0.0005	0.0645
	case47	1.0000	0.0042	1.0110	0.0007	0.1880
	case48	1.0000	0.0042	1.0065	0.0007	0.1878
	case49	1.0000	0.0042	1.0063	0.0008	0.1889
	case50	1.0000	0.0041	1.0095	0.0007	0.1140
case51	1.0000	0.0041	1.0127	0.0007	0.1146	
case52	1.0000	0.0041	1.0076	0.0007	0.1148	
Experiment LEU-COMP-THERM-049 (18 cases)	lct49-01	1.0000	0.0034	0.9923	0.0006	0.294
	lct49-02	1.0000	0.0034	0.9937	0.0006	0.293
	lct49-03	1.0000	0.0034	0.9929	0.0006	0.297
	lct49-04	1.0000	0.0034	0.9931	0.0006	0.300
	lct49-05	1.0000	0.0042	0.9944	0.0007	0.255
	lct49-06	1.0000	0.0042	0.9946	0.0007	0.256
	lct49-07	1.0000	0.0042	0.9932	0.0007	0.253

Table XII-13. Critical Benchmarks Selected for Validation of the Criticality Model for External Configurations Containing Mixtures with Low Enriched Uranium (Continued)

Experiment	Case Name	Benchmark Values		Calculated Values (MCNP)		
		k_{eff}	σ_{exp}	k_{eff}	σ_{calc}	AENCF
Experiment LEU-COMP-THERM-049 (18 cases) (continued)	lct49-08	1.0000	0.0042	0.9921	0.0007	0.258
	lct49-09	1.0000	0.0037	0.9933	0.0006	0.227
	lct49-10	1.0000	0.0037	0.9946	0.0007	0.227
	lct49-11	1.0000	0.0037	0.9933	0.0006	0.227
	lct49-12	1.0000	0.0037	0.9924	0.0007	0.231
	lct49-13	1.0000	0.0036	0.9935	0.0006	0.271
	lct49-14	1.0000	0.0036	0.9941	0.0006	0.272
	lct49-15	1.0000	0.0036	0.9937	0.0006	0.271
	lct49-16	1.0000	0.0036	0.9938	0.0007	0.254
	lct49-17	1.0000	0.0036	0.9929	0.0007	0.258
lct49-18	1.0000	0.003	0.997	0.0006	0.251	
Experiment LEU-SOL-THERM-001 (1 case)	leust1	0.9991	0.0029	1.01182	0.00101	0.05186
Experiment LEU-SOL-THERM-002 (3 cases)	leust21	1.0038	0.004	0.99855	0.00058	0.02513
	leust22	1.0024	0.0037	0.99659	0.00064	0.0283
	leust23	1.0024	0.0044	1.0009	0.0006	0.02684
Experiment LEU-SOL-THERM-003 (9 cases)	lst3-1	0.9997	0.0039	0.9993	0.0004	0.0186
	lst3-2	0.9993	0.0042	0.9971	0.00038	0.0166
	lst3-3	0.9995	0.0042	1.0015	0.00037	0.0164
	lst3-4	0.9995	0.0042	0.9954	0.00038	0.0162
	lst3-5	0.9997	0.0048	0.9990	0.00031	0.0133
	lst3-6	0.9999	0.0049	0.9992	0.0003	0.0129
	lst3-7	0.9994	0.0049	0.9972	0.0003	0.0127
	lst3-8	0.9993	0.0052	1.0008	0.00025	0.0114
	lst3-9	0.9996	0.0052	0.9973	0.00025	0.0114
Experiment LEU-SOL-THERM-008 (4 cases)	lst8_72	0.9999	0.0014	1.0038	0.0002	0.0152
	lst8_74	1.0002	0.0015	1.0023	0.0002	0.0154
	lst8_76	0.9999	0.0014	1.0028	0.0002	0.0153
	lst8_78	0.9999	0.0014	1.0040	0.0002	0.0153
Experiment LEU-SOL-THERM-009 (3 cases)	lst9_92	0.9998	0.0014	1.0018	0.0005	0.0155
	lst9_93	0.9999	0.0014	1.0021	0.0002	0.0157
	lst9_94	0.9999	0.0014	1.0022	0.0002	0.0158
Experiment LEU-SOL-THERM-018 (6 cases)	RUN133	0.9992	0.001	1.0033	0.0002	0.0183
	RUN142	0.9996	0.001	1.0042	0.0003	0.0187
	RUN143	0.9996	0.001	1.0045	0.0003	0.0188
	RUN144	0.9997	0.001	1.0033	0.0003	0.0187
	RUN145	0.9992	0.001	1.0038	0.0003	0.0187
	RUN146	0.9996	0.001	1.0037	0.0003	0.0186

Source: Moscalu 2004, Section 5.3

The experiments listed in Table XII-12 cover configuration classes NF-1 through NF-5 and FF-1 through FF-3 for configurations containing mixtures of low enriched uranium external to the waste package.

XII.4.2 Range of Applicability of Selected Critical Benchmark Experiments

Tables XII-13 and XII-14 summarize the range of applicability of the experiments listed in Table XII-12. The information is excerpted from Moscalu (2004, Section 5.3).

Table XII-14. Range of Applicability of Critical Benchmark Experiments Selected for Comparison with External Configurations Containing Mixtures with Low Enriched Uranium (Set 1)

Category/ Description	Parameter	Experiment LEU-COMP- THERM-033 (52 cases)	Experiment LEU-COMP- THERM-049 (18 cases)	Experiment LEU-SOL- THERM-001 (1 case)	Experiment LEU-SOL- THERM-002 (3 cases)	Experiment LEU-SOL- THERM-003 (9 cases)
Materials/ Fissionable Material	Fissionable Element	Uranium	Uranium	Uranium	Uranium	Uranium
	Physical Form	Uranium fluoride	UO ₂	Aqueous solution of uranyl fluoride	Aqueous solution of uranium oxy- fluoride	Aqueous solution of uranyl nitrate
	Isotopic Composition	2 to 3 wt% ²³⁵ U	2.35 wt% ²³⁵ U	5 wt% ²³⁵ U	4.9 wt% ²³⁵ U	10 wt% ²³⁵ U
	Atomic Density (atoms/b-cm)	²³⁵ U: 6.23e-05 to 2.35e-04	²³⁵ U: 3.69e-4 ²³⁸ U: 6.94e-03	²³⁵ U: 1.24e-4 ²³⁸ U: 2.35e-3	²³⁵ U: 5.67e-05 – 6.16e-05 ²³⁸ U: 1.09e-03 – 1.18e-03	²³⁵ U: 4.34e-05 – 7.64e-05 ²³⁸ U: 3.82e-04 – 6.73e-04
	Temperature	Room Temp.	Room Temp.	Room Temp.	Room Temp.	Room Temp.
Materials/ Moderator	Element	H, C	H	H	H	H
	Physical Form	Paraffin	Solution	Solution	Solution	Solution
	Atomic Density (atoms/b-cm)	H: 3.09e-02 to 6.06e-02 C: 1.49e-02 to 2.91e-02	1.47e-02 to 2.20e- 02	5.62e-02	6.17e-02 to 6.22e- 02	5.89e-02 to 6.23e-02
	Ratio to Fissile Material	H/ ²³⁵ U = 133.4 to 973	2 to 3	454	1001 to 10098	770 to 1437
	Temperature	Room Temp.	Room Temp.	Room Temp.	Room Temp.	Room Temp.
Materials/ Reflector	Material/ Physical Form	Reflected by paraffin, polyethylene or Plexiglas	Reflected by polyethylene	Unreflected	Unreflected or reflected by water	Unreflected
Materials/ Neutron Absorber	Element	None	None	None	None	None
	Physical Form	N/A	N/A	N/A	N/A	N/A
	Atomic Density (atoms/b-cm)	N/A	N/A	N/A	N/A	N/A

Table XII-14. Range of Applicability of Critical Benchmark Experiments Selected for Comparison with External Configurations Containing Mixtures with Low Enriched Uranium (Set 1) (Continued)

Category/Description	Parameter	Experiment LEU-COMP-THERM-033 (52 cases)	Experiment LEU-COMP-THERM-049 (18 cases)	Experiment LEU-SOL-THERM-001 (1 case)	Experiment LEU-SOL-THERM-002 (3 cases)	Experiment LEU-SOL-THERM-003 (9 cases)
Geometry	Heterogeneity	Rectangular stacks of UF ₂ or UF ₄ – paraffin cubes	Array of boxes in rectangular geometry	Homogeneous solution in a cylindrical vessel	Homogeneous solution in a spherical vessel	Homogeneous solution in a spherical tank
	Shape	Parallelepiped	Parallelepiped	Cylinder	Sphere	Sphere
Neutron Energy	AENCF ^b	0.0617 to 0.1953 MeV	0.2270 to 0.3000 MeV	0.0519 MeV	0.0251 to 0.0283 MeV	0.0114 to 0.0186 MeV
	EALF ^b	0.0541 to 0.393 eV	0.899 to 27.8 eV	0.0629 eV	0.0395 to 0.0416 eV	3.46e-02 to 4.14e-02 eV
	Neutron Energy Spectra ^a	T: 13.4 to 42.4 % I: 26.2 to 41.3 % F: 31.5 to 45.3 %	T: 7.1 to 15.0 % I: 38.6 to 41.0 % F: 46.2 to 51.9 %	T: 28.6% I: 31.2% F: 40.2%	T: 43.9 to 45.5% I: 24.1 to 25.3% F: 30.4 to 32.1%	T: 37.6 to 49.1 % I: 22.7 to 27.3% F: 28.2 to 35.1%
	Fission Rate vs. Neutron Energy ^a	T: 80.6 to 95.4 % I: 2.6 to 12.9 % F: 2.0 to 6.6 %	T: 63.2 to 72.9 % I: 19.0 to 25.6 % F: 8.1 to 10.9 %	T: 93.6% I: 4.6% F: 1.8%	T: 96.6 to 96.9% I: 2.3 to 2.5% F: 0.8 to 1.1%	T: 96.2 to 97.6% I: 2 to 3.1% F: 0.4 to 0.7%

Source: Moscalu 2004, Section 5.3

NOTES: ^a Spectral range defined as follows: thermal (T) [0 to 1 eV], intermediate (I) [1eV to 100 keV], fast (F) [100 keV to 20 MeV].
^b AENCF = average energy of a neutron causing fission, EALF = energy of average lethargy causing fission.

Table XII-15. Range of Applicability of Critical Benchmark Experiments Selected for Comparison with External Configurations Containing Mixtures with Low Enriched Uranium (Set 2)

Category/Description	Parameter	Experiment LEU-SOL-THERM-008 (4 cases)	Experiment LEU-SOL-THERM-009 (3 cases)	Experiment LEU-SOL-THERM-018 (6 cases)
Materials/ Fissionable Material	Fissionable Element	Uranium	Uranium	Uranium
	Physical Form	Aqueous solution of uranyl nitrate	Aqueous solution of uranyl nitrate	Aqueous solution of uranyl nitrate
	Isotopic Composition	9.97 wt% ²³⁵ U	9.97 wt% ²³⁵ U	9.97 wt% ²³⁵ U
	Atomic Density (atoms/b-cm)	²³⁵ U: 6.14e-05 ²³⁸ U: 5.47e-04	²³⁵ U: 6.26e-05 ²³⁸ U: 5.57e-04	²³⁵ U: 7.87e-5 to 8.04e-05 ²³⁸ U: 7.01e-04 to 7.16e-04
	Temperature	Room Temp.	Room Temp.	Room Temp.
Materials Moderator	Element	H	H	H
	Physical Form	Solution	Solution	Solution
	Atomic Density (atoms/b-cm)	5.86e-02	5.85e-02	5.87e-02 to 5.91e-02
	Ratio to Fissile Material	951 to 956	934 to 936	731 to 751
	Temperature	Room Temp.	Room Temp.	Room Temp.
Materials/ Reflector	Material/ Physical Form	Reflected by concrete	Reflected by borated concrete	Reflected by concrete

Table XII-15. Range of Applicability of Critical Benchmark Experiments Selected for Comparison with External Configurations Containing Mixtures with Low Enriched Uranium (Set 2) (Continued)

Category/Description	Parameter	Experiment LEU-SOL-THERM-008 (4 cases)	Experiment LEU-SOL-THERM-009 (3 cases)	Experiment LEU-SOL-THERM-018 (6 cases)
Materials/Neutron Absorber	Element	None	None	None
	Physical Form	N/A	N/A	N/A
	Atomic Density (atoms/b-cm)	N/A	N/A	N/A
Geometry	Heterogeneity	Homogeneous solution contained in a cylindrical tank	Homogeneous solution contained in a cylindrical tank	Homogeneous solution in a rectangular slab tank
	Shape	Cylinder	Cylinder	Rectangular slab
Neutron Energy	AENCF	0.0152 to 0.0154 MeV	0.0155 to 0.0158 MeV	0.0183 to 0.0188 MeV
	EALF	3.84e-02 eV	3.89e-02 eV	0.042 to 0.0425 eV
	Neutron Energy Spectra ^a	T: 41.5 to 41.7% I: 25.9 to 26% F: 32.4 to 35%	T: 40.8 to 41 % I: 26.2 to 26.3% F: 32.8 to 32.9%	T: 36.5 to 37.0 % I: 28.0 to 28.3 % F: 34.9 to 35.2 %
	Fission Rate vs Neutron Energy ^a	T: 96.8% I: 2.6% F: 0.6%	T: 96.7% I: 2.7% F: 0.6%	T: 96.0% I: 3.3% F: 0.7

Source: Moscalu 2004, Section 5.3

NOTE: ^a Spectral range defined as follows: thermal (T) [0 to 1 eV], intermediate (I) [1eV to 100 keV], fast (F) [100 keV to 20 MeV].

XII.4.3 Calculation of Lower-Bound Tolerance Limit

The calculated LBTL value using DFTL method for the current set is $f(x) = 0.9842$ (Moscalu 2004, Section 5.3). Figure XII-3 presents the k_{eff} values and the calculated LBTL for this set of benchmark experiments.

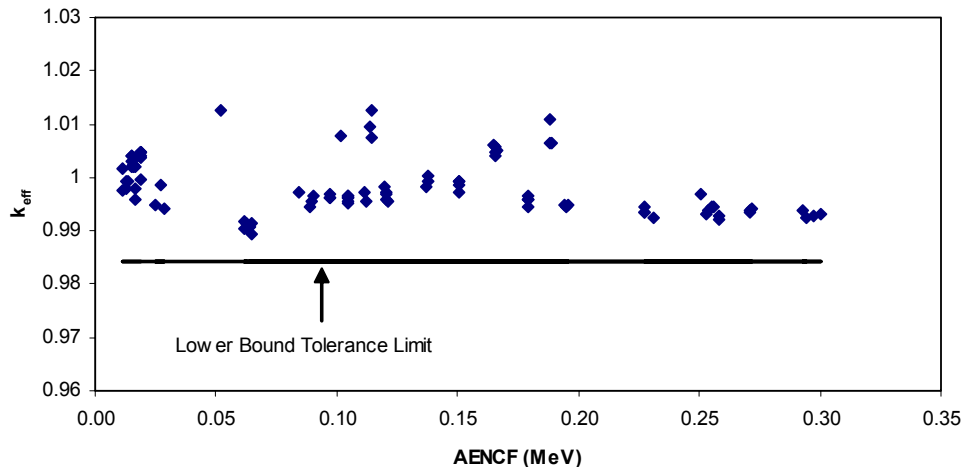

NOTE: AENCF = average energy of a neutron causing fission.

Figure XII-3. Lower-Bound Tolerance Limit Applicable for Configurations Containing LEU External to the Waste Package

XII.5 MIXTURE OF URANIUM AND PLUTONIUM SYSTEMS

Selection of the criticality benchmark experiments for mixture of uranium and plutonium systems, determination of the range of applicability of the selected benchmarks, and the calculation of the LBTL are discussed in the following three sections.

XII.5.1 Selection of the Criticality Benchmark Experiments

The criticality experiments selected for inclusion in the benchmarking of the criticality computational method must be representative of the types of materials, conditions, and parameters to be represented. A sufficient number of experiments with varying experimental parameters should be selected for inclusion in the benchmarking to ensure as wide an area of applicability as feasible and statistically significant results. While there is no absolute guideline for the minimum number of critical experiments necessary to benchmark a computational method, the use of only a few (i.e., less than 10) experiments should be accompanied by a suitable technical basis supporting the rationale for acceptability of the results (Dean and Tayloe 2001, p. 5).

For the present application (configurations with mixtures of IEU fissile material external to the waste package), the criticality benchmark experiments have been selected based on their fissile content, moderator and geometry. The benchmark experiments are from the *International Handbook of Evaluated Criticality Safety Benchmark Experiments* (NEA 2003) unless otherwise noted. The set of criticality benchmark experiments has been constructed to accommodate large variations in the range of parameters of the configurations and also to provide adequate statistics for the LBTL calculations.

The selected benchmark experiments containing a total of 120 individual cases are presented in Table XII-16 along with the results of the MCNP code calculations. All cases have been run using the isotopic libraries described in Table 2 (Section 4.2.2).

Table XII-16. Critical Benchmarks Selected for Validation of the Criticality Model for External Configurations Containing Mixtures of Uranium and Plutonium Isotopes

Experiment	Case Name	Benchmark Values		Calculated Values (MCNP)		
		k_{eff}	σ_{exp}	k_{eff}	σ_{calc}	AENCF
Experiment MIX-SOL-THERM-001 (12 cases)	pnl3187	1.0000	0.0016	0.9976	0.0012	0.0417
	pnl3391	1.0000	0.0016	0.9943	0.0012	0.0411
	pnl3492	1.0000	0.0016	0.9975	0.0012	0.0431
	pnl3593	1.0000	0.0016	0.9973	0.0011	0.0459
	pnl3694	1.0000	0.0016	1.0026	0.0012	0.0445
	pnl3795	1.0000	0.0016	1.0017	0.0012	0.0400
	pnl3896	1.0000	0.0016	1.0024	0.0012	0.0232
	pnl3897	1.0000	0.0016	1.0045	0.0011	0.0142
	pnl3898	1.0000	0.0016	1.0029	0.0010	0.0299
	pnl3808	1.0000	0.0016	1.0020	0.0011	0.0213
	pnl3999	1.0000	0.0052	1.0092	0.0011	0.0296
	pnl5300	1.0000	0.0052	1.0080	0.0011	0.0288

Table XII-16. Critical Benchmarks Selected for Validation of the Criticality Model for External Configurations Containing Mixtures of Uranium and Plutonium Isotopes (Continued)

Experiment	Case Name	Benchmark Values		Calculated Values (MCNP)		
		k_{eff}	σ_{exp}	k_{eff}	σ_{calc}	AENCF
Experiment MIX-SOL-THERM-002 (3 cases)	pnl1158	1.0000	0.0024	1.0069	0.0007	0.0038
	pnl1159	1.0000	0.0024	1.0074	0.0006	0.0037
	pnl1161	1.0000	0.0024	1.0079	0.0007	0.0061
Experiment MIX-SOL-THERM-003 (10 cases)	awre1	0.9985	0.0020	1.0147	0.0010	0.0315
	awre2	0.9960	0.0020	1.0157	0.0012	0.0315
	awre3	0.9935	0.0020	1.012	0.0012	0.0320
	awre4	0.9909	0.0020	1.0051	0.0012	0.0319
	awre5	0.9981	0.0022	1.0085	0.0010	0.0104
	awre6	0.9959	0.0022	1.0107	0.0010	0.0104
	awre7	0.9935	0.0022	1.0080	0.0010	0.0105
	awre8	0.9988	0.0025	1.0128	0.0008	0.0069
	awre9	0.9958	0.0025	1.0094	0.0009	0.0066
	awre10	0.9964	0.0025	1.0102	0.0008	0.0066
Experiment MIX-SOL-THERM-004 (9 cases)	pnl1577	1.0000	0.0033	0.9958	0.0012	0.0589
	pnl1678	1.0000	0.0033	0.9974	0.0012	0.0504
	pnl1783	1.0000	0.0078	0.9992	0.0012	0.0534
	pnl1868	1.0000	0.0078	1.0039	0.0013	0.0343
	pnl1969	1.0000	0.0033	1.0000	0.0012	0.0334
	pnl2070	1.0000	0.0033	0.9996	0.0014	0.0377
	pnl2565	1.0000	0.0033	1.0015	0.0012	0.0129
	pnl2666	1.0000	0.0033	1.0018	0.0011	0.0117
	pnl2767	1.0000	0.0078	1.0061	0.0011	0.0123
Experiment MIX-SOL-THERM-005 (7 cases)	msl5-63	1.0000	0.0037	0.9877	0.0008	0.013
	msl5-64	1.0000	0.0037	1.0045	0.0007	0.012
	msl5-71	1.0000	0.0037	1.0032	0.0008	0.033
	msl5-72	1.0000	0.0037	1.0001	0.0008	0.032
	msl5-74	1.0000	0.0037	0.9922	0.0009	0.037
	msl5-75	1.0000	0.0037	0.9898	0.0009	0.059
	msl5-76	1.0000	0.0037	0.9974	0.0007	0.049
Experiment MIX-SOL-THERM-006 (6 cases)	C1	1.0000	0.0011	0.9992	0.0006	0.0352
	C2	1.0000	0.0010	1.0018	0.0006	0.0375
	C3	1.0000	0.0012	1.0025	0.0005	0.0380
	C4	1.0000	0.0016	1.0041	0.0005	0.0396
	C5	1.0000	0.0011	1.0039	0.0005	0.0405
	C6	1.0000	0.0014	1.0021	0.0005	0.0404
Experiment MIX-COMP-THERM-012 (33 cases)	c1_mc50	1.0042	0.0058	0.9764	0.0007	0.0709
	c2_mc50	1.0042	0.0058	0.9770	0.0007	0.0712
	c3_mc50	1.0042	0.0058	0.9743	0.0007	0.0708
	c4_mc50	1.0042	0.0058	0.9804	0.0007	0.0709
	c5_mc50	1.0042	0.0058	0.9756	0.0007	0.0710
	c6_mc50	1.0042	0.0058	0.9805	0.0007	0.0714

Table XII-16. Critical Benchmarks Selected for Validation of the Criticality Model for External Configurations Containing Mixtures of Uranium and Plutonium Isotopes (Continued)

Experiment	Case Name	Benchmark Values		Calculated Values (MCNP)			
		k_{eff}	σ_{exp}	k_{eff}	σ_{calc}	AENCF	
Experiment MIX-COMP-THERM-012 (33 cases) (continued)	c7_mc50	1.0023	0.0036	1.0353	0.0006	0.0268	
	c8_mc50	1.0023	0.0036	1.0309	0.0006	0.0264	
	c9_mc50	1.0023	0.0036	1.0281	0.0006	0.0267	
	c10_mc50	1.0023	0.0036	1.0277	0.0006	0.0268	
	c11_mc50	1.0023	0.0036	1.0264	0.0006	0.0265	
	c12_mc50	1.0023	0.0036	1.0287	0.0007	0.0266	
	c13_mc50	1.0023	0.0036	1.0372	0.0007	0.0266	
	c14_mc50	1.0002	0.0027	1.0231	0.0007	0.0464	
	c15_mc50	1.0002	0.0027	1.0234	0.0008	0.0464	
	c16_mc50	1.0002	0.0027	1.0194	0.0007	0.0463	
	c17_mc50	1.0002	0.0027	1.0188	0.0007	0.0457	
	c18_mc50	1.0002	0.0027	1.0172	0.0007	0.0459	
	c19_mc50	1.0002	0.0027	1.0167	0.0007	0.0456	
	c20_mc50	1.0004	0.0037	1.0173	0.0008	0.0571	
	c21_mc50	1.0004	0.0037	1.0160	0.0008	0.0581	
	c22_mc50	1.0004	0.0037	1.0129	0.0008	0.0571	
	c23_mc50	0.9997	0.0049	1.0108	0.0007	0.0388	
	c24_mc50	0.9997	0.0049	1.0122	0.0008	0.0386	
	c25_mc50	0.9997	0.0049	1.0112	0.0007	0.0384	
	c26_mc50	0.9997	0.0049	1.0092	0.0007	0.0382	
	c27_mc50	0.9997	0.0049	1.0089	0.0007	0.0380	
	c28_mc50	0.9997	0.0049	1.0104	0.0007	0.0381	
	c29_mc50	0.9997	0.0049	1.0113	0.0007	0.0376	
	c30_mc50	0.9997	0.0049	1.0090	0.0007	0.0379	
	c31_mc50	1.0007	0.0052	0.9963	0.0009	0.0493	
	c32_mc50	1.0007	0.0052	0.9970	0.0008	0.0490	
	c33_mc50	1.0007	0.0052	0.9935	0.0008	0.0498	
	Experiment PU-MET-MIXED-001 (6 cases)	81-1-B5	1.0002	0.0037	1.0003	0.0017	0.4567
		81-1AB5	1.0002	0.0032	0.9991	0.0019	0.4505
		81-2-B5	1.0005	0.0025	1.0040	0.0019	0.3800
		81-3-b5	1.0000	0.0025	1.0094	0.0019	0.3405
		81-4-b5	1.0001	0.0025	1.0165	0.0017	0.2178
		81-5-b5	1.0003	0.0025	1.0163	0.0017	0.2145
Experiment PU-COMP-MIXED-001 (5 cases)	case1	0.9986	0.0041	1.0286	0.0009	1.7019	
	case2	1.0000	0.0068	1.0188	0.0013	0.6331	
	case3	0.9990	0.0067	1.0150	0.0013	0.2753	
	case4	1.0000	0.0066	0.9853	0.0014	0.2878	
	case5	0.9989	0.0072	1.0084	0.0013	0.0999	
Experiment PU-COMP-MIXED-002 (29 cases)	case1	0.9990	0.0046	1.0318	0.0009	1.0458	
	case2	0.9990	0.0046	1.0309	0.0009	1.0303	
	case3	0.9990	0.0046	1.0253	0.0008	1.0089	

Table XII-16. Critical Benchmarks Selected for Validation of the Criticality Model for External Configurations Containing Mixtures of Uranium and Plutonium Isotopes (Continued)

Experiment	Case Name	Benchmark Values		Calculated Values (MCNP)		
		k_{eff}	σ_{exp}	k_{eff}	σ_{calc}	AENCF
Experiment PU-COMP-MIXED-002 (29 cases) (continued)	case4	0.9990	0.0046	1.0199	0.0009	0.9807
	case5	0.9990	0.0046	1.0139	0.0008	0.9433
	case6	1.0000	0.0075	1.0168	0.0009	0.4377
	case7	1.0000	0.0075	1.0183	0.0008	0.4334
	case8	1.0000	0.0075	1.0177	0.0008	0.4234
	case9	1.0000	0.0075	1.0189	0.0009	0.4137
	case10	1.0000	0.0073	1.0282	0.0009	0.1836
	case11	1.0000	0.0073	1.0248	0.0009	0.1872
	case12	1.0000	0.0073	1.0250	0.0008	0.1919
	case13	1.0000	0.0073	1.0220	0.0010	0.1932
	case14	1.0000	0.0073	1.0268	0.0009	0.1933
	case15	1.0000	0.0073	1.0224	0.0009	0.1938
	case16	1.0000	0.0073	1.0188	0.0009	0.1917
	case17	0.9988	0.0055	1.0062	0.0009	0.1963
	case18	0.9988	0.0055	1.0071	0.0008	0.2040
	case19	0.9988	0.0055	1.0068	0.0009	0.2040
	case20	0.9988	0.0055	1.0078	0.0009	0.2060
	case21	0.9988	0.0055	1.0075	0.0009	0.2063
	case22	0.9988	0.0055	1.0118	0.0009	0.2038
	case23	1.0000	0.0068	1.0058	0.0009	0.0770
	case24	1.0000	0.0068	1.0090	0.0009	0.0770
	case25	1.0000	0.0068	1.0081	0.0009	0.0777
	case26	1.0000	0.0068	1.0103	0.0010	0.0774
	case27	1.0000	0.0068	1.0090	0.0009	0.0776
	case28	1.0000	0.0068	1.0095	0.0009	0.0777
	case29	1.0000	0.0068	1.0104	0.0009	0.0785

Source: Moscalu 2004, Section 5.4

NOTE: AENCF = average energy of a neutron causing fission.

The experiments listed in Table XII-15 cover configuration classes NF-1 through NF-5 and FF-1 through FF-3 for configurations containing mixtures of low enriched uranium external to the waste package.

XII.5.2 Range of Applicability of Selected Critical Benchmark Experiments

Tables XII-17 and XII-18 summarize the range of applicability of the experiments listed in Table XII-16. The information is excerpted from Moscalu (2004, Section 5.4).

Table XII-17. Range of Applicability of Critical Benchmark Experiments Selected for Comparison with External Configurations Containing Mixtures with Plutonium and Uranium (Set 1)

Category/Description	Parameter	Experiment MIX-SOL-THERM-001 (12 cases)	Experiment MIX-SOL-THERM-002 (3 cases)	Experiment MIX-SOL-THERM-003 (10 cases)	Experiment MIX-SOL-THERM-004 (9 cases)	Experiment MIX-SOL-THERM-005 (7 cases)
Materials/ Fissionable Material	Fissionable Element	Plutonium + Uranium	Plutonium + Uranium	Plutonium + Uranium	Plutonium + Uranium	Plutonium + Uranium
	Physical Form	Pu-U nitrate solution	Pu-U nitrate solution	Pu-U nitrate solution	Pu-U nitrate solution	Pu-U nitrate solution
	Isotopic Composition	91.1 to 91.57 wt% ²³⁹ Pu in Pu 0.44 to 0.71 wt % ²³⁵ U in U	91.1 wt% ²³⁹ Pu in Pu 0.7 to 2.29 wt % ²³⁵ U in U	94 wt% ²³⁹ Pu in Pu 0.72 wt % ²³⁵ U in U	91.1 wt% ²³⁹ Pu in Pu 0.56 wt % ²³⁵ U in U	91.1 wt% ²³⁹ Pu in Pu 0.56 wt % ²³⁵ U in U
	Atomic Density (atoms/b-cm)	²³⁹ Pu: 1.08e-04 to 4.51e-04 ²³⁵ U: 1.35e-06 to 6.86e-06	²³⁹ Pu: 2.69e-05 to 2.80e-04 ²³⁵ U: 1.94e-06 to 4.6e-06	²³⁹ Pu: 7.47e-05 to 2.40e-04 ²³⁵ U: 7.6e-07 to 4.2e-06	²³⁹ Pu: 9.60e-05 to 3.98e-04 ²³⁵ U: 9.16e-07 to 3.8e-06	²³⁹ Pu: 9.42e-05 to 3.97e-04 ²³⁵ U: 9.09e-07 to 3.8e-06
	Temperature	Room Temp.	Room Temp.	Room Temp	Room Temp	Room Temp
Materials/ Moderator	Element	H	H	H	H	H
	Physical Form	Solution	Solution	Solution	Solution	Solution
	Atomic Density (atoms/b-cm)	H: 5.45e-02 to 6.71e-02	H: 6.48e-02 to 6.55e-02	H: 5.73e-02 to 6.44e-02	H: 5.41e-02 to 6.35e-02	H: 5.40e-02 to 6.35e-02
	Ratio to Fissile Material	H/ ²³⁹ Pu = 125 to 569 (annular tank)	H/ ²³⁹ Pu = 2317 to 2434	H/ ²³⁹ Pu = 239 to 1556	H/ ²³⁹ Pu = 126 to 664	H/ ²³⁹ Pu = 136 to 674
	Temperature	Room Temp.	Room Temp.	Room Temp	Room Temp	Room Temp
Materials/ Reflector	Material/ Physical Form	Reflected by water	Reflected by water	Reflected by water and polyethylene	Reflected by water or concrete	Reflected by water or concrete
Materials/ Neutron Absorber	Element	B, Cd	None	None	None	None
	Physical Form	B in concrete, Cd in inserts	N/A	N/A	N/A	N/A
	Atomic Density (atoms/b-cm)	N/A	N/A	N/A	N/A	N/A
Geometry	Heterogeneity	Homogeneous solution in annular cylinder; Center contained solution and/or inserts	Homogeneous solution in a cylindrical vessel	Homogeneous solution in a cylindrical vessel	Homogeneous solution in a cylindrical vessel	Homogeneous solution in slab tank
	Shape	Cylinder	Cylinder	Cylinder	Cylinder	Parallelepiped
Neutron Energy	AENCF	0.0142 to 0.0459 MeV	0.0039 to 0.0061 MeV	0.0065 to 0.0320 MeV	0.0117 to 0.0589 MeV	0.012 to 0.059 MeV
	EALF	0.0541 to 0.393 eV	0.0423 to 0.0433 eV	0.0477 to 0.144 eV	0.06669 to 0.302 eV	0.0667 to 0.361 eV
	Neutron Energy Spectra ^a	T: 5.1 to 27.5 % I: 32.1 to 40.1 % F: 40.4 to 54.8 %	T: 47.4 to 48.5 % I: 22.6 to 23.1 % F: 28.7 to 29.5 %	T: 11.2 to 39.2 % I: 26.0 to 36.9 % F: 33.8 to 51.9 %	T: 6.1 to 24.6 % I: 31.8 to 39.0 % F: 43.6 to 55.7 %	T: 5.6 to 24.9 % I: 31.7 to 38.8 % F: 43.4 to 55.6 %
	Fission Rate vs. Neutron Energy ^a	T: 84.1 to 93.5 % I: 5.7 to 13.8 % F: 0.8 to 2.1 %	T: 98.3 to 98.5 % I: 1.3 to 1.4 % F: 0.1 to 0.3 %	T: 90.6 to 97.9% I: 1.8 to 7.9% F: 0.3 to 1.4%	T: 82.8 to 96.1% I: 3.4 to 14.5 % F: 0.5 to 2.7%	T: 82.7 to 96.1% I: 3.4 to 14.6 % F: 0.6 to 2.7%

Source: Moscalu 2004, Section 5.4

NOTES: ^a Spectral range defined as follows: thermal (T) [0 to 1 eV], intermediate (I) [1eV to 100 keV], fast (F) [100 keV to 20 MeV].

^b AENCF = average energy of a neutron causing fission, EALF = energy of average lethargy causing fission.

Table XII-18. Range of Applicability of Critical Benchmark Experiments Selected for Comparison with External Configurations Containing Mixtures with Plutonium and Uranium (Set 2)

Category/Description	Parameter	Experiment MIX-SOL-THERM-006 (6 cases)	Experiment MIX-COMP-THERM-012 (33 cases)	Experiment PU-MET-MIXED-001 (6 cases)	Experiment PU-COMP-MIXED-001 (5 cases)	Experiment PU-COMP-MIXED-002 (29 cases)
Materials/ Fissionable Material	Fissionable Element	Plutonium + Uranium	Plutonium + uranium	Plutonium	Plutonium	Plutonium
	Physical Form	Pu-U nitrate solution	Pu-U oxide (MOX)	Pu metal pellets	Pu oxide	Pu oxide
	Isotopic Composition	Pu: 75.4 wt % ²³⁹ Pu ; 20.4 wt % ²⁴⁰ Pu ; 2.9 wt % ²⁴¹ Pu 0.56 wt % ²³⁵ U in U	Pu: 8 and 23 wt% ²⁴⁰ Pu in Pu 0.151 wt% ²³⁵ U in U	95.17 wt% ²³⁹ Pu	75.2 to 97.7 wt% ²³⁹ Pu in Pu	75.2 to 97.7 wt% ²³⁹ Pu in Pu
	Atomic Density (atoms/b-cm)	²³⁹ Pu: 1.72e-04 to 1.73e-04 ²³⁵ U: 2.66e-06 to 2.7e-06	²³⁹ Pu: 6.51e-05 to 1.09e-04 ²³⁵ U: 1.01e-06 to 2.9e-06	²³⁹ Pu: 3.67e-02	²³⁹ Pu: 7.00e-04 to 1.09e-02	²³⁹ Pu: 7.00e-04 to 1.09e-02
	Temperature	Room temp.	Room temp.	Room temp.	Room temp.	Room temp.
Materials/ Moderator	Element	H	H, C	H, C, Si as scatterer	H, C	H, C
	Physical Form	Solution	Polystyrene	Polyethylene, sand	Polystyrene	Polystyrene
	Atomic Density (atoms/b-cm)	H: 5.48e-02 to 5.52e-02	H: 4.15e-02 to 5.66e-02 C: 3.56e-02 to 4.54e-02	In Polyethylene pellets: H: 7.83e-02 C: 3.91e-02 Silicone dioxide: Si: 1.57e-02 and 1.98e-02	H: 5.51e-04 to 4.57e-02 C: 0 to 4.50e-02	H: 5.51e-04 to 4.57e-02 C: 0 to 4.50e-02
	Ratio to Fissile Material	H/X = 297 to 303	H/ ²³⁹ Pu = 174 to 724	Not available	H/ ²³⁹ Pu = 0.05 to 65.37	H/ ²³⁹ Pu = 0.05 to 65.37
	Temperature	Room temp.	Room temp.	Room temp.	Room temp.	Room temp.
Materials/ Reflector	Material/ Physical Form	Reflected by water	Unreflected or reflected by Plexiglas	Reflected by sand and depleted uranium	Unreflected	Reflected by Plexiglas
Materials/ Neutron Absorber	Element	Gd	None	B	None	None
	Physical Form	Solution	N/A	B ₄ C	N/A	N/A
	Atomic Density (atoms/b-cm)	Gd: 1.15e-07 to 2.67e-06	N/A	¹⁰ B: 1.10e-02 ¹¹ B: 4.46e-02	N/A	N/A
Geometry	Heterogeneity	Homogeneous solution in cylindrical tank	Arrays of MOX/polystyrene compact blocks in rectangular configurations	Complex heterogeneous arrangements of Pu and silicon dioxide pellets placed in array of rods	Arrays of Pu-oxide/polystyrene compact blocks in rectangular configurations	Arrays of Pu-oxide/polystyrene compact blocks in rectangular configurations
	Shape	Cylinder	Slab, parallelepiped	Cylindrical array of rods	Rectangular slab	Rectangular slab
Neutron Energy	AENCF	0.035 to 0.040 MeV	0.026 to 0.071 MeV	0.214 to 0.457 MeV	0.100 to 1.702 MeV	0.077 to 1.046 MeV
	EALF	Not available	0.070 to 0.264 eV	1.29 to 5540 eV	1.67 to 1.02e6 eV	0.749 to 6800 eV
	Neutron Energy Spectra ^a	Not available	T: 7.2 to 27.9% I: 31.2 to 38.8% F: 40.9 to 54.0%	T: 0.2 to 18.5% I: 31.9 to 52.3% F: 47.5 to 54.6%	T: 0 to 2.3 % I: 5.9 to 39.7 % F: 58. to 94.1 %	T: 0.1 to 3.2 % I: 13.9 to 39.2 % F: 57.6 to 86.0 %
	Fission Rate vs Neutron Energy ^a	Not available	T: 86.0 to 96% I: 3.0 to 11.8% F: 1.0 to 2.6%	T: 4.1 to 70.6% I: 18.1 to 63.7% F: 11.4 to 32.2%	T: 0.2 to 65.2% I: 5.3 to 57.7% F: 5.2 to 94.5 %	T: 23 to 72.4% I: 19.8 to 44.9% F: 4.0 to 57.2 %

Source: Moscalu 2004, Section 5.4

NOTES: ^a Spectral range defined as follows: thermal (T) [0 to 1 eV], intermediate (I) [1eV to 100 keV], fast (F) [100 keV to 20 MeV].
AENCF = average energy of a neutron causing fission, EALF = energy of average lethargy causing fission.

XII.5.3 Calculation of Lower-Bound Tolerance Limit

The calculated lower bound tolerance limit value using DFTL method for this set of benchmark experiments is 0.9644. Figure XII-4 presents the k_{eff} values and the calculated LBTL (Moscal 2004, Section 5.4).

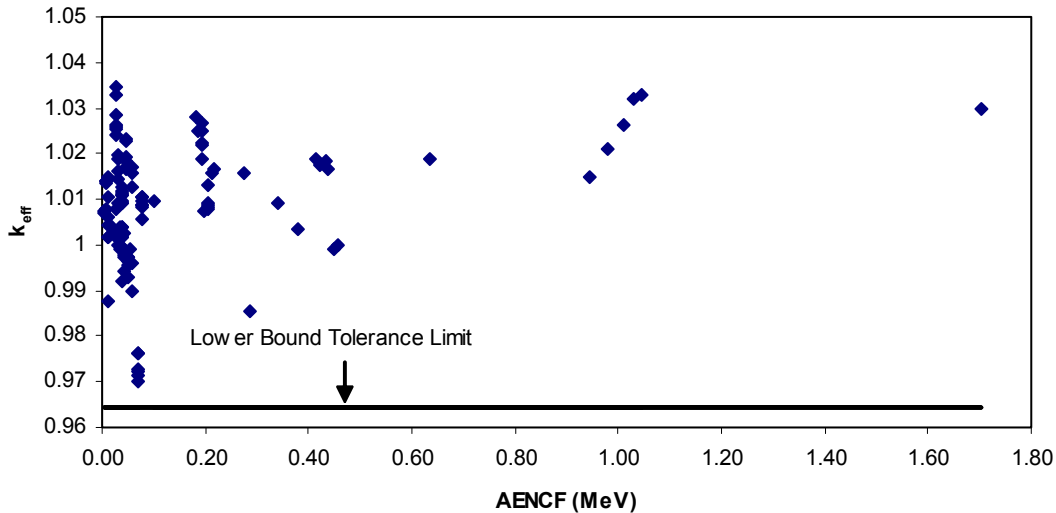

NOTE: AENCF = average energy of a neutron causing fission.

Figure XII-4. Lower Bound Tolerance Limit Applicable for Configurations Containing Mixtures of Plutonium and Uranium External to the Waste Package

XII.6 ^{233}U SYSTEMS

Selection of the criticality benchmark experiments for ^{233}U systems, determination of the range of applicability of the selected benchmarks, and the calculation of the LBTL are discussed in the following three sections.

XII.6.1 Selection of the Criticality Benchmark Experiments

The criticality experiments selected for inclusion in the benchmarking of the criticality computational method must be representative of the types of materials, conditions, and parameters to be represented. A sufficient number of experiments with varying experimental parameters should be selected for inclusion in the benchmarking to ensure as wide an area of applicability as feasible and statistically significant results. While there is no absolute guideline for the minimum number of critical experiments necessary to benchmark a computational method, the use of only a few (i.e., less than 10) experiments should be accompanied by a suitable technical basis supporting the rationale for acceptability of the results (Dean and Tayloe 2001, p. 5).

For the present application (configurations with mixtures of ^{233}U external to the waste package), the criticality benchmark experiments have been selected based on their fissile content, moderator and geometry. The benchmark experiments are from the *International Handbook of Evaluated Criticality Safety Benchmark Experiments* (NEA 2003) unless otherwise noted. The

set of criticality benchmark experiments has been constructed to accommodate large variations in the range of parameters of the configurations and also to provide adequate statistics for the LBTL calculations.

The selected benchmark experiments containing a total of 83 individual cases are presented in Table XII-19 along with the results of the MCNP code calculations. All cases have been run using the isotopic libraries described in Table 2 (Section 4.2.2).

Table XII-19. Critical Benchmarks Selected for Validation of the Criticality Model for External Configurations Containing ²³³U

Experiment	Case Name	Benchmark Values		Calculated Values (MCNP)		
		K _{eff}	σ _{exp}	K _{eff}	σ _{calc}	AENCF
Experiment U-233-SOL-THERM-001 (5 cases)	ust001-1	1	0.0031	1.0018	0.0005	0.0038
	ust001-2	1.0005	0.0033	1.0004	0.0006	0.0041
	ust001-3	1.0006	0.0033	0.9994	0.0006	0.0043
	ust001-4	0.9998	0.0033	0.9989	0.0006	0.0043
	ust001-5	0.9999	0.0033	0.9987	0.0006	0.0043
Experiment U-233-SOL-THERM-002 (17 cases)	ust02-04	1.004	0.0087	1.0103	0.0011	0.026
	ust02-05	1.004	0.0087	0.9973	0.0011	0.0214
	ust02-08	1.004	0.0087	1.0113	0.001	0.0173
	ust02-10	1.004	0.0087	1.0096	0.0011	0.0138
	ust02-11	1.004	0.0087	1.0126	0.001	0.0115
	ust02-12	1.004	0.0087	1.0006	0.001	0.01
	ust02-14	1.004	0.0087	0.9875	0.0009	0.0098
	ust02-15	1.004	0.0087	1.0026	0.001	0.0083
	ust02-17	1.004	0.0087	0.9897	0.0009	0.0072
	ust02-18	1.004	0.0087	1.0029	0.0008	0.0066
	ust02-19	1.004	0.0087	1.0102	0.0008	0.0056
	ust02-22	1.004	0.0087	0.9967	0.0011	0.0356
	ust02-24	1.004	0.0087	0.9976	0.0012	0.049
	ust02-34	1.004	0.0087	1.0038	0.0011	0.0223
ust02-35	1.004	0.0087	1.0103	0.0009	0.0155	
ust02-36	1.004	0.0087	1.0115	0.0009	0.0096	
ust02-38	1.004	0.0087	1.0097	0.0008	0.0075	
Experiment U-233-SOL-THERM-003 (10 cases)	ust03-40	0.9995	0.0087	1.008	0.001	0.0387
	ust03-41	0.9991	0.0151	1.026	0.0011	0.0397
	ust03-42	1.0007	0.0087	1.0044	0.0011	0.04
	ust03-45	1.0015	0.0126	1.014	0.0011	0.061
	ust03-55	1.0006	0.0122	1.0197	0.0011	0.0693
	ust03-57	1.0012	0.0087	1.0244	0.001	0.0209
	ust03-58	1.0016	0.0087	1.0167	0.001	0.0138
	ust03-61	1.0016	0.0087	1.0133	0.001	0.0108
	ust03-62	1.0018	0.0087	1.0107	0.001	0.0095
ust03-65	1.0008	0.0087	1.0073	0.0008	0.0056	

Table XII-19. Critical Benchmarks Selected for Validation of the Criticality Model for External Configurations Containing ²³³U (Continued)

Experiment	Case Name	Benchmark Values		Calculated Values (MCNP)		
		k _{eff}	σ _{exp}	k _{eff}	σ _{calc}	AENCF
Experiment U-233-SOL-THERM-004 (10 cases)	ust04-03	1.0039	0.0088	1.0086	0.0011	0.0257
	ust04-06	1.0034	0.0086	1.0113	0.001	0.0208
	ust04-20	1.0041	0.0089	1.0006	0.0011	0.0353
	ust04-25	1.0051	0.0089	0.9936	0.0011	0.0493
	ust04-27	1.002	0.0105	1.0119	0.0011	0.0479
	ust04-28	1.002	0.0104	1.0063	0.0011	0.0425
	ust04-30	1.0037	0.009	0.9988	0.0011	0.043
	ust04-33	1.002	0.0102	1.0087	0.0011	0.0215
Experiment U-233-SOL-THERM-005 (2 cases)	ust05-01	1.000	0.004	1.0054	0.0009	0.0094
	ust05-02	1000	0.0049	1.0075	0.0009	0.0078
Experiment U-233-SOL-THERM-008 (1 case)	ust008	1.0006	0.0029	0.9986	0.0004	0.003
Experiment U-233-SOL-THERM-006 (12 cases)	m35	1.000	0.0035	1.023	0.0008	0.0576
	m36	1.000	0.0035	1.0113	0.0008	0.0583
	m37	1.000	0.0035	0.9996	0.0008	0.0588
	m38	1.000	0.0035	1.0011	0.0008	0.0584
	m45	1.000	0.0035	1.0186	0.0011	0.059
	m61	1.000	0.0035	1.0228	0.0008	0.0345
	m62	1.000	0.0035	1.0132	0.0008	0.0346
	m63	1.000	0.0035	0.9988	0.0008	0.0352
	m65	1.000	0.0035	0.9939	0.0008	0.0350
	m77	1.000	0.0035	0.9939	0.0011	0.0358
	m78	1.000	0.0035	0.9932	0.0011	0.0358
m79	1.000	0.0035	0.9929	0.0011	0.0355	
Experiment HEU-COMP-MIXED-001 (26 cases)	hcm-1	1.000	0.0059	1.0027	0.001	0.1045
	hcm-2	1.0012	0.0059	1.0059	0.0011	0.1053
	hcm-5	0.9985	0.0056	0.9963	0.001	0.7833
	hcm-6	0.9953	0.0056	0.9899	0.001	0.7962
	hcm-7	0.9997	0.0038	0.9949	0.001	0.8015
	hcm-8	0.9984	0.0052	0.9915	0.0011	0.6872
	hcm-9	0.9983	0.0052	0.9931	0.0011	0.6536
	hcm-10	0.9979	0.0052	0.9941	0.001	0.6494
	hcm-11	0.9983	0.0052	0.9934	0.0011	0.6385
	hcm-12	0.9972	0.0052	0.996	0.0011	0.6358
	hcm-13	1.0032	0.0053	0.9977	0.0011	0.6309
	hcm-15	1.0083	0.005	0.9949	0.0011	0.4671
	hcm-16	1.0001	0.0046	0.9926	0.0011	0.4692
	hcm-17	0.9997	0.0046	1.0012	0.0011	0.4647
hcm-18	1.0075	0.0046	1	0.001	0.4625	
hcm-19	1.0039	0.0047	1	0.0011	0.5191	

Table XII-19. Critical Benchmarks Selected for Validation of the Criticality Model for External Configurations Containing ²³³U (Continued)

Experiment	Case Name	Benchmark Values		Calculated Values (MCNP)		
		k _{eff}	σ _{exp}	k _{eff}	σ _{calc}	AENCF
Experiment HEU-COMP-MIXED-001 (26 cases) (continued)	hcm-20	1.006	0.0065	1.0051	0.0015	0.5357
	hcm-21	1.0026	0.0064	1.0046	0.0016	0.5378
	hcm-22	1.0013	0.0064	0.9995	0.0016	0.5371
	hcm-23	0.9995	0.0053	1.0056	0.0015	0.535
	hcm-24	1.002	0.0053	1.0003	0.0016	0.5352
	hcm-25	0.9983	0.0053	0.997	0.0014	0.5333
	hcm-26	0.9998	0.0053	1.0001	0.0015	0.5283
	hcm-27	0.9991	0.0053	0.9978	0.0016	0.5302
	hcm-28	1.0037	0.0053	1.0033	0.0015	0.541
hcm-29	0.9992	0.0052	0.9998	0.0014	0.5401	
Experiment HEU-MET-THERM-001 (1 case)	hmt001	1.0010	0.0060	1.0097	0.0010	0.0215
Experiment HEU-MET-THERM-014 (1 case)	hmt14	0.9939	0.0015	1.0125	0.0004	0.0233

Source: Moscalu 2004, Section 5.5

XII.6.2 Range of Applicability of Selected Critical Benchmark Experiments

Tables XII-19 and XII-20 summarize the range of applicability of the experiments listed in Table XII-18. The information is excerpted from Moscalu (2004, Section 5.5).

Table XII-20. Range of Applicability of Critical Benchmark Experiments Selected for Comparison with External Configurations Containing ²³³U (Set 1)

Category/ Description	Parameter	Experiment U-233-SOL- THERM-001 (5 cases)	Experiment U-233-SOL- THERM-002 (17 cases)	Experiment U-233-SOL- THERM-003 (10 cases)	Experiment U-233-SOL- THERM-004 (8 cases)	Experiment U-233-SOL- THERM-005 (2 cases)
Materials/ Fissionable Material	Fissionable Element	Uranium	Uranium	Uranium	Uranium	Uranium
	Physical Form	Uranyl nitrate	Uranyl nitrate	Uranyl fluoride	Uranyl nitrate	Uranyl nitrate
	Isotopic Composition	97.7 wt% U-233	98.7 wt% U-233	98.7 wt% U-233	98.7 wt% U-233	98.7 wt% U-233
	Atomic Density (atoms/b-cm)	U-233: 4.33e-05 to 5.00e-05	U-233: 8.71e-05 to 9.84e-04	U-233: 8.56e-05 to 1.55e-03	U-233: 4.15e-04 to 9.84e-04	U-233: 1.27e-04 and 1.60e-04
	Temperature	Room Temp.	Room Temp.	Room Temp.	Room Temp.	Room Temp.

Table XII-20. Range of Applicability of Critical Benchmark Experiments Selected for Comparison with External Configurations Containing ²³³U (Set 1) (Continued)

Category/ Description	Parameter	Experiment U-233-SOL- THERM-001 (5 cases)	Experiment U-233-SOL- THERM-002 (17 cases)	Experiment U-233-SOL- THERM-003 (10 cases)	Experiment U-233-SOL- THERM-004 (8 cases)	Experiment U-233-SOL- THERM-005 (2 cases)
Materials/ Moderator	Element	H	H	H	H	H
	Physical Form	Solution	Solution	Solution	Solution	Solution
	Atomic Density (atoms/b-cm)	6.63e-02 to 6.64e-02	5.62e-02 to 6.56e-02	6.05e-02 to 6.57e-02	5.62e-02 to 6.22e-02	6.50e-02 and 6.54e-02
	Ratio to Fissile Material	1324 to 1533	57.1 to 752.6	39.4 to 775	57.1 to 149.2	405 and 514
	Temperature	Room Temp.	Room Temp.	Room Temp.	Room Temp.	Room Temp.
Materials/ Reflector	Material/ Physical Form	Unreflected	Reflected by paraffin	Reflected by paraffin	Reflected by paraffin	Reflected by water
Materials/ Neutron Absorber	Element	B	None	None	None	None
	Physical Form	Solution	N/A	N/A	N/A	N/A
	Atomic Density (atoms/b-cm)	B10:2.65e-07 to 1.01e-6	N/A	N/A	N/A	N/A
Geometry	Heterogeneity	Solution contained in an Al sphere	Solution contained in an Al sphere	Solution contained in single Al cylindrical vessel	Solution contained in single Al cylindrical vessel	Solution in spherical or cylindrical Al vessel
	Shape	Sphere	Sphere	Cylindrical	Cylindrical	Cylindrical/ Spherical
Neutron Energy	AENCF ^b	0.0038 to 0.0043 MeV	0.0056 to 0.0490 MeV	0.0056 to 0.0693 MeV	0.0208 to 0.0493 MeV	0.0078 to 0.0094 MeV
	EALF ^b	0.0392 to 0.0417 eV	0.0464 to 0.471 eV	0.046 to 1.03 eV	0.138 to 0.486 eV	0.055 to 0.062 eV
	Neutron Energy Spectra ^a	T: 48.9 to 52.5 % I: 21.0 to 22.6% F: 26.5 to 28.5%	T: 7.7 to 42.2 % I: 24.8 to 33.9% F: 33.0 to 58.3%	T: 5.2 to 42.6 % I: 24.6 to 34.2 % F: 32.7 to 60.6 %	T: 7.8 to 17.2 % I: 32.4 to 34.0 % F: 50.4 to 58.3 %	T: 31.3 to 35.5 % I: 27.1 to 28.5 % F: 37.4 to 40.1 %
	Fission Rate vs. Neutron Energy ^a	T: 94.0 to 94.8% I: 5.0 to 5.8% F: 0.2 %	T: 76.0 to 92.5% I: 7.1 to 33.5% F: 0.2 to 2.8 %	T: 54.5 to 92.7% I: 7.0 to 41.5 % F: 0.3 to 4.0 %	T: 63.8 to 79.5% I: 19.3 to 33.4 % F: 1.2 to 2.8 %	T: 88.9 to 90.5% I: 9.0 to 10.6 % F: 0.4 to 0.5 %

Source: Moscalu 2004, Section 5.5

NOTES: ^a Spectral range defined as follows: thermal (T) [0 to 1 eV], intermediate (I) [1eV to 100 keV], fast (F) [100 keV to 20 MeV].

^b AENCF = average energy of a neutron causing fission, EALF = energy of average lethargy causing fission.

Table XII-21. Range of Applicability of Critical Benchmark Experiments Selected for Comparison with External Configurations Containing ²³³U (Set 2)

Category/ Description	Parameter	Experiment U-233-SOL- THERM-006 (6 cases)	Experiment U-233-SOL- THERM-008 (1 case)	Experiment HEU-COMP- MIXED-001 (26 cases)	Experiment HEU-MET- THERM-001 (1 case)	Experiment HEU-MET- THERM-014 (1 case)
Materials/ Fissionable Material	Fissionable Element	Uranium	Uranium	Uranium	Uranium	Uranium
	Physical Form	Uranyl nitrate	Uranyl nitrate	UO ₂	Uranium metal foils	Uranium metal foils
	Isotopic Composition	97.56 or 97.54 wt% U-233;	97.67 wt% U-233	93.15 wt% U-235	93.23 wt% U- 235	93.23 wt% U- 235
	Atomic Density (atoms/b-cm)	U-233: 5.14e-04 to 8.64e-04	U-233: 3.34e-05	U-235: 4.48e-03 to 1.39e-02	U-235: 3.84e-02 to 4.28e-02	U-235: 3.84e-02 to 4.38e-02
	Temperature	Room temp.	Room temp.	Room temp.	Room temp.	Room temp.
Materials/ Moderator	Element	H	H	H	H, C Si as scatterer	H, C Si as scatterer
	Physical Form	Water in aqueous solution of uranyl nitrate	Solution	Water, Alcohol-water solution, Plexiglas	Plates of polyethylene and silicon glass	Plates of polyethylene and silicon glass
	Atomic Density (atoms/b-cm)	5.89e-02 to 6.15e-02	6.64e-02	Fuel Region: 2.16e- 2 (few cases) 5.68e-2 (plexiglas) 6.24e-2 (alcohol- water)	H: 8.23e-02 to 8.28e-02 C: 4.11e-02 to 4.14e-02 Si: 2.17 to 2.24e- 02	H: 8.19e-02 to 8.34e-02 C: 4.10e-02 to 4.17e-02 Si: 2.20 to 2.28e- 02
	Ratio to Fissile Material	H/X = 69 to 121	H/X = 1324 to 1533	H/X = 0 to 49	Not available	H/X: Not available Si/U235 = 42
	Temperature	Room temp.	Room temp.	Room temp.	Room Temp.	Room Temp.
Materials/ Reflector	Material/ Physical Form	Unreflected	Unreflected	Reflected by polyethylene	Reflected by polyethylene	Reflected by polyethylene
Materials/ Neutron Absorber	Element	None	None	None	None	None
	Physical Form	N/A	N/A	N/A	N/A	N/A
	Atomic Density (atoms/b-cm)	N/A	N/A	N/A	N/A	N/A
Geometry	Heterogeneity	Arrays of cans containing uranyl nitrate solution in rectangular geometry	Solution contained in an Al sphere	Complex arrays of cans in rectangular geometry	Rectangular column of plates and foils	Rectangular column of plates and foils
	Shape	Parallelepiped	Sphere	Cylinder	Parallelepiped	Parallelepiped
Neutron Energy	AENCF^b	0.0344 to 0.0599 MeV	0.0030 MeV	0.1045 to 0.8015 MeV	0.0212 MeV	0.0234 MeV
	EALF^b	0.303 to 0.896 eV	0.0037 eV	0.438 to 2070 eV	0.0865 eV	Not Available
	Neutron Energy Spectra^a	T: 6.1 to 10.7 % I: 34.8 to 35.4 % F: 54.4 to 58.4 %	T: 57.0 % I: 19.3 % F: 23.7 %	T: 4.3 to 25.3 % I: 14.2 to 25.9 % F: 56.0 to 81.4 %	T: 22.7 % I: 27.7 % F: 49.7 %	Not Available
	Fission Rate vs. Neutron Energy^a	T: 55.0 to 68.4 % I: 29.7 to 41.7 % F: 2.0 to 3.3 %	T: 95.5 % I: 4.3 % F: 0.2 %	T: 25.4 to 78.0 % I: 16.4 to 43.1 % F: 5.6 to 49.9 %	T: 91.2 % I: 7.7 % F: 1.2 %	Not Available

Source: Moscalu 2004, Section 5.5

NOTES: ^a Spectral range defined as follows: thermal (T) [0 to 1 eV], intermediate (I) [1eV to 100 keV], fast (F) [100 keV to 20 MeV].

^b AENCF = average energy of a neutron causing fission, EALF = energy of average lethargy causing fission.

XII.6.3 Calculation of Lower-Bound Tolerance Limit

The calculated lower bound tolerance limit value using DFTL method for the current set is $f(x) = 0.9748$ (Moscalu 2004, Section 5.5.3). Figure XII-5 presents the k_{eff} values and the calculated LBTL for this set of benchmark experiments.

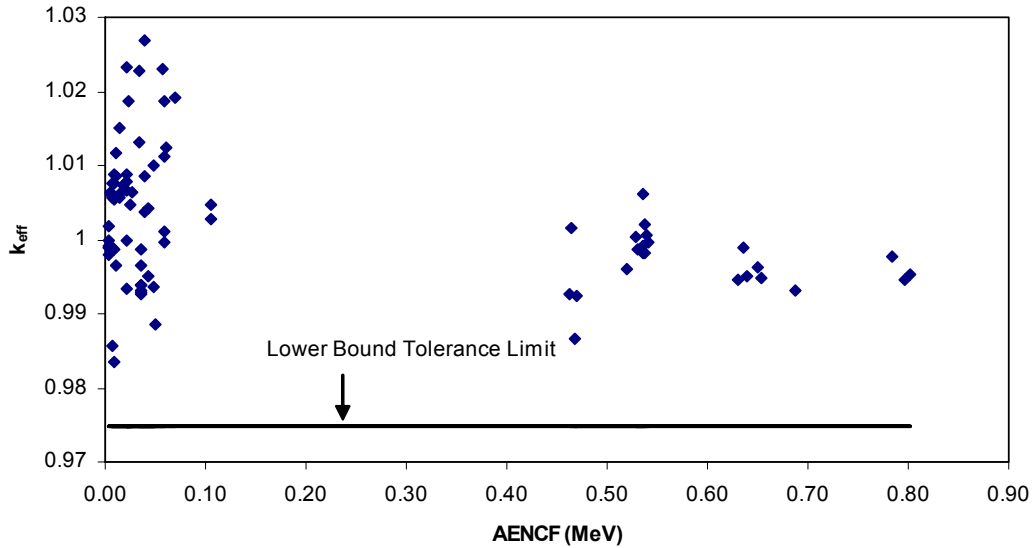

NOTE: AENCF = average energy of a neutron causing fission.

Figure XII-5. Lower-Bound Tolerance Limit Applicable for Configurations Containing ^{233}U External to the Waste Package