

MOL.19980825.0207

### Calculation Cover Sheet

Complete only applicable items.

1. QA: L

Page: 1 Of: 39



2. Calculation Title  
Criticality Evaluation of Degraded Internal Configurations for a 44 BWR Waste Package

3. Document Identifier (including Revision Number)  
BBA000000-01717-0210-00020 REV 00

4. Total Pages  
39

5. Total Attachments  
4

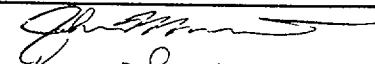
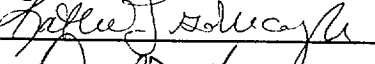
6. Attachment Numbers - Number of pages in each  
I-1, II-5, III-29, IV-1

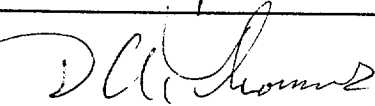
	Print Name	Signature	Date
7. Originator	John R. Massari Katherin L. Goluoglu	 	8/25/98 8/25/98
8. Checker	David P. Henderson		8/25/98
9. Lead Design Engineer	Daniel A. Thomas		08/26/98

10. Remarks  
  
*PCG compliance review by W. Wallin 8/25/98*  
*This calculation was in process at the time QAP-SI-0 Rev. 4 was issued, and thus, was completed under QAP-SI-0 Rev. 3 in accordance with the provision in Section 2 of Rev. 4. JM 8/26/98*

#### Revision History

11. Revision No.	12. Date Approved	13. Description of Revision
00	8/26/98	Initial Issue

**Table of Contents**

<b><u>Item</u></b>	<b><u>Page</u></b>
1. PURPOSE.....	4
2. METHOD.....	4
3. ASSUMPTIONS.....	4
4. USE OF COMPUTER SOFTWARE.....	5
4.1 SOFTWARE APPROVED FOR QA WORK.....	5
4.2 SOFTWARE ROUTINES.....	6
5. CALCULATION.....	7
5.1 INPUTS.....	7
5.1.1 Spent Fuel Assembly Parameters.....	7
5.1.2 Intact Waste Package Geometry Parameters.....	7
5.1.3 Material Properties.....	8
5.1.4 BWR Waste Stream Data.....	11
5.2 CALCULATION OF NUMBER DENSITIES FOR DEGRADED BASKET MATERIAL.....	11
5.3 CALCULATION OF NUMBER DENSITIES FOR FUEL REGION.....	12
5.4 MCNP4B2 MODEL DESCRIPTION.....	20
6. RESULTS.....	23
6.1 CRITICALITY CALCULATIONS OF DEGRADED INTERNAL CONFIGURATIONS.....	23
6.2 REGRESSION ANALYSIS AND WASTE STREAM COVERAGE ESTIMATES.....	26
7. REFERENCES.....	30
8. ATTACHMENTS.....	31

**List of Tables**

<u>Item</u>	<u>Page</u>
TABLE 3-1. PRINCIPAL LONG-TERM BURNUP CREDIT ISOTOPES .....	4
TABLE 5.1-1. GENERAL ASSEMBLY PARAMETERS .....	7
TABLE 5.1-2. 44 BWR WP BASKET COMPONENT VOLUMES (TBV).....	7
TABLE 5.1-3. DENSITIES OF NON-FUEL MATERIALS .....	8
TABLE 5.1-4. ATOMIC WEIGHTS IN G/MOLE.....	9
TABLE 5.1-5. CHEMICAL COMPOSITONS OF WP AND FUEL ASSEMBLY ALLOYS MODELED.....	10
TABLE 5.3-1. ASSEMBLY FUEL ENRICHMENT DESCRIPTIONS .....	13
TABLE 5.3-2. NODE DESCRIPTION.....	13
TABLE 5.3-3. MODERATOR DENSITIES AND FUEL TEMPERATURES FOR ALL NODES AND BURNUPS .....	14
TABLE 5.3-4. NODAL POWERS (MW) BY CYCLE FOR EACH NODE AND BURNUP .....	16
TABLE 6.1-1 $K_{EFF}$ RESULTS FOR BASE CASE 44 BWR WP WITH FULLY DEGRADED BASKET .....	23
TABLE 6.1-2. EFFECTS OF VARIATIONS FROM THE BASE CASE CONFIGURATION FOR 4.5% INITIAL ENRICHMENT, 35 GWd/MTU SNF AT 25,000 YEARS .....	26
TABLE 6.2-1 BASE CASE PEAK $K_{EFF}$ VALUES AND TIMES FOR VARIOUS ENRICHMENTS AND BURNUPS.....	26
TABLE 6.2-2. REGRESSION RESULTS FOR BASE CASE PEAK $K_{EFF}$ AS A FUNCTION OF BURNUP AND ENRICHMENT.....	27
TABLE 6.2-3. PERCENTAGE OF THE BWR WASTE STREAM WHICH WOULD EXCEED A GIVEN $K_{EFF}$ VALUE FOR VARIOUS DEGRADED CONFIGURATIONS.....	29
TABLE 8-1. LIST OF ATTACHMENTS .....	31

**List of Figures**

<u>Item</u>	<u>Page</u>
FIGURE 5.3-1. PATH B MODEL FOR TOP AND BOTTOM NODES.....	17
FIGURE 5.3-2. PATH B MODEL FOR NODES 2-9 .....	18
FIGURE 5.4-1. GE 8x8 BWR FUEL ASSEMBLY .....	21
FIGURE 5.4-2. 44 BWR WP WITH FULLY DEGRADED BASKET AND UNIFORMLY DISTRIBUTED CORROSION PRODUCTS IN VOLUME OUTSIDE OF FUEL CHANNELS (BASE CASE) .....	22
FIGURE 5.4-3. 44 BWR WP WITH FULLY DEGRADED BASKET AND 2.7 CM VERTICAL SEPARATION BETWEEN ASSEMBLIES .....	22
FIGURE 6.1-1. TIME EFFECTS ON $K_{EFF}$ OF FULLY DEGRADED 44 BWR WP BASKET CONTAINING 4.5% INITIAL ENRICHMENT, 35 GWd/MTU SNF.....	25
FIGURE 6.2-1. BURNUP/ENRICHMENT COMBINATIONS YIELDING PEAK $K_{EFF}$ VALUES OF 0.93 AND 0.98 FOR THE BASE CASE CONFIGURATION PLOTTED AGAINST THE BWR WASTE STREAM.....	28

## 1. PURPOSE

The purpose of this calculation is to perform an example criticality evaluation for degraded internal configurations of a boiling water reactor (BWR) waste package (WP) containing 44 spent nuclear fuel (SNF) assemblies.

## 2. METHOD

The BWR assembly design considered is based on the General Electric (GE) 8x8 assembly (see Section 5.1). Depletion analyses for various assembly average enrichment and burnup (expressed as gigawatt days/metric ton uranium; GWd/MTU) combinations are performed using the SAS2H/ORIGEN-S sequence of SCALE 4.3 (CSCI: 30011-2002; Ref. 7.5). For each burnup/enrichment combination, 10 axial fuel nodes are utilized to allow the effects of differences in burnup along the assembly length to be considered. Degraded configuration  $k_{eff}$  values are calculated using MCNP4B2 (MCNP4B2; CSCI: 30033-2003 V4B2LV; Ref. 7.6). Calculations are performed for various decay times, burnups, initial enrichments, and configurations. A regression fit of  $k_{eff}$  as a function of burnup and enrichment is generated for the purpose of estimating the amount of the BWR waste stream which could exceed a given  $k_{eff}$  in a given configuration.

## 3. ASSUMPTIONS

- 3.1 Principal Isotope (PI) burnup credit is assumed to be an acceptable method to account for reduced reactivity of SNF in criticality evaluations. The basis for this assumption is Controlled Design Assumption (CDA) Key 009 (Ref. 7.11). This assumption is used throughout Section 5.
- 3.2 For SNF, the list of "Principal Isotopes" previously established (Ref. 7.16, p. 3-26) for long-term criticality control was used. The 29 principal isotopes are shown in Table 3-1. This assumption is used throughout Sections 5.

Table 3-1. Principal Long-Term Burnup Credit Isotopes

-	Mo-95	Tc-99	Ru-101	Rh-103
Ag-109	Nd-143	Nd-145	Sm-147	Sm-149
Sm-150	Sm-151	Sm-152	Eu-151	Eu-153
Gd-155	U-233	U-234	U-235	U-236
U-238	Np-237	Pu-238	Pu-239	Pu-240
Pu-241	Pu-242	Am-241	Am-242m	Am-243

- 3.3 It is assumed that the WP is fully flooded for this calculation. The basis for this assumption is that it is conservative, and moderation is a required condition for criticality in commercial SNF

with an enrichment of less than 5 wt% (Ref. 7.15, p. 68). Furthermore, scenarios leading to a fully flooded WP have been proposed in previous QAP-3-9 analyses (Ref. 7.13). This assumption is used throughout Section 5.

- 3.4 It is assumed that the thermal shunt material will be aluminum Alloy 6061 (see Table 5.1-4). The basis for this is that Reference 7.7 does not provide information on the material for this component. This assumption is used throughout Section 5.
- 3.5 The SNF composition is determined via SAS2H/ORIGEN-S calculations. The input values used do not represent a specific assembly, but are assumed to model a representative assembly, based on the anticipated waste stream described in Ref. 7.2, and the available data in Ref. 7.4. This representative assembly is assumed to be an 8x8 array of fuel rods with a central water rod and several gadolinium-bearing rods. In addition, the assembly has a natural uranium blanket on the top and bottom ends. The values used for fuel composition, moderator density, and fuel temperature as input into SAS2H/ORIGEN-S are shown in Section 5.3. These values are based on data provided in Ref. 7.4. This assumption is used throughout Section 5.

## 4. USE OF COMPUTER SOFTWARE

### 4.1 Software Approved for QA Work

The calculation of  $k_{\text{eff}}$  of degraded internal WP configurations is performed with the MCNP4B2 computer code (CSCI: 30033-2003; Ref. 7.14). MCNP4B2 calculates  $k_{\text{eff}}$  for a variety of geometric configurations with neutron cross sections for elements and isotopes described in the Evaluated Nuclear Data File version B-V (ENDF-B/V) and version B-VI (ENDF-B/VI). MCNP4B2 is appropriate for the fuel geometries and materials required for these analyses. The calculations using the MCNP4B2 software are executed on a Hewlett-Packard workstation. The software qualification of the MCNP4B2 software, including problems related to calculation of  $k_{\text{eff}}$  for fissile systems, is summarized in the Software Qualification Report for the Monte Carlo N-Particle code (Ref. 7.6). The MCNP4B2 evaluations performed for this calculation are fully within the range of the validation for the MCNP4B2 software used. Access to and use of the MCNP4B2 software for this calculation is granted by Software Configuration Management and is performed in accordance with the QAP-SI series procedures. Inputs and outputs for the MCNP4B2 software are included as attachments as described in the following engineering calculation.

The calculation of the BWR spent fuel isotopics is performed with the SAS2H code sequence, which is a part of the SCALE 4.3 code system (CSCI: 30011-2002 V4.3; Ref. 7.21). SAS2H is designed for spent fuel depletion calculations to determine spent fuel isotopic content, decay heat rates, and radiation source terms. Thus, SAS2H is appropriate for the generation of spent fuel isotopics documented herein. The calculations using the SAS2H software are executed on a PC. The software qualification of the SAS2H software, including benchmark problems related to generation of isotope contents, is summarized in the Software Qualification Report for the SCALE Modular Code system (Ref. 7.5). The SAS2H evaluations performed for this design are fully within the range of the validation for the SAS2H software used. The associated 44-group cross section library is used for these calculations. Access to

and use of the SAS2H software for this calculation is granted by Software Configuration Management and is performed in accordance with the QAP-SI series procedures. Inputs and outputs for the SAS2H software are included as attachments as described in the following engineering calculation.

## 4.2 Software Routines

Microsoft Excel 97, loaded on a Pentium II PC. Calculations of corrosion product volumes and number densities, and regression fits of burnup, enrichment, and  $k_{\text{eff}}$  values, are performed electronically in this spreadsheet software package. The location of the electronic copy of the BWRcrit.xls spreadsheet containing all inputs and outputs is given in Section 8, and a printed copy of this spreadsheet is provided in Attachment III. All calculations/data manipulations performed in BWRcrit.xls are described in Section 5 and may also be examined electronically.

MS-DOS Qbasic version 1.1 BASIC interpreter, loaded on a Pentium II PC. Calculation of number densities for the principal isotopes from the SAS2H/ORIGEN-S output is performed using a short BASIC software routine entitled AMIGO10B.BAS, which then automatically places the data into the appropriate spot in an MCNP4B2 input file template. AMIGO10B.BAS is an automation of a simple number density calculation and data manipulation task, which is easily checked by hand. AMIGO10B.BAS does not generate data. The input consists of 10 ASCII files containing the isotope gram concentration tables from 10 SAS2H/ORIGEN-S output files, one for each of the 10 fuel region nodes (for a given burnup/enrichment combination), and one or more MCNP4B2 template files. The template files are simply standard MCNP4B2 input with the mnemonics "FUELTOT##" and "FUELNUM##" in place of the cell card total number density and the material card for the fuel region (## is replaced by the numbers 01 to 10 for each of the 10 nodes). The AMIGO10B.BAS output is simply one or more MCNP4B2 input files. See Section 8 for the location of the SAS2H/ORIGEN-S summary files containing the gram concentrations of the principal isotopes (\*.sum), the MCNP4B2 template files, and the resulting MCNP4B2 input files. The source code for AMIGO10B.BAS is provided in Attachment II.

Mathcad 7 Professional, loaded on a Pentium II PC. Calculation of the fraction of the BWR waste stream exceeding various peak  $k_{\text{eff}}$  values in various degraded configurations is performed in the Mathcad worksheet BWRcrit.mcd. This calculation is included as Attachment IV, and an electronic copy of the BWRcrit.mcd worksheet is included as discussed in Section 8.

## 5. CALCULATION

### 5.1 Inputs

#### 5.1.1 Spent Fuel Assembly Parameters

A representative GE 8x8 BWR assembly is modeled, with a central water rod instead of four fuel rods in the center. The parameters chosen to represent this assembly are arbitrary, but based on the information in Ref. 7.2 and 7.4. Table 5.1-1 shows the general parameters that determine the geometric model of the assembly. These values should be considered TBV (to be verified).

Table 5.1-1. General assembly parameters

Fuel pellet radius	0.5207 cm
Active fuel length	368.9096 cm
Clad thickness	0.0813 cm
Clad outside radius	0.6134 cm
Rod pitch	1.6256 cm
Water rod outside radius	1.3094 cm
Water rod inside radius	1.2281 cm
Initial uranium loading	171177.7 g/assy
Assembly pitch	15.24 cm

#### 5.1.2 Intact Waste Package Geometry Parameters

A sketch of the 44 BWR waste package, including component thicknesses and materials of composition, utilized to develop the MCNP model is provided in Attachment I. In the absence of detailed component drawings for this WP, the volumes listed in Table 5.1-2 are utilized. These values should be considered TBV.

Table 5.1-2. 44 BWR WP basket component volumes

Component	Volume (m <sup>3</sup> )
Single fuel cell tube	0.01438
All carbon steel components (including tubes)	0.91129
All borated stainless steel components	0.27199
All aluminum alloy 6061 components	0.09042

### 5.1.3 Material Properties

Densities of non-fuel materials used in this calculation are provided in Table 5.1-3.

Table 5.1-3. Densities of non-fuel materials

Material	Density	Reference
A 516 Grade 55 Carbon Steel	7832 kg/m <sup>3</sup>	Reference 7.9, p. I-1
Aluminum Alloy 6061	2713 kg/m <sup>3</sup>	Reference 7.8, Table NF-2
SS316B6A (B-SS)	7745 kg/m <sup>3</sup>	Reference 7.9, p. I-12
Hematite (Fe <sub>2</sub> O <sub>3</sub> )	5240 kg/m <sup>3</sup>	Reference 7.12, p. B-104
Goethite (FeOOH)	4264 kg/m <sup>3</sup>	Reference 7.3, p. 240
Diaspore (AlOOH)	3400 kg/m <sup>3</sup>	Reference 7.3, p. 172
Zircaloy-4	6560 kg/m <sup>3</sup>	Reference 7.9, p. I-16
Alloy C-22	8690 kg/m <sup>3</sup>	Reference 7.9, p. I-3
Water	1000 kg/m <sup>3</sup>	Reference 7.9, p. I-19

The atomic weights of isotopes are listed in Table 5.1-5 (Ref. 7.9, p. 32). Avogadro's Number [ $N_A$ ] =  $0.602252 \text{ (g-mol)}^{-1} \times 10^{24}$  (Ref. 7.9, p. 34). Chemical compositions of alloys used in this calculation are given in Table 5.1-6. This information is obtained from qualified QAP-3-9 analyses, or is considered established fact, and is therefore considered qualified.

Table 5.1-4 Material identification

ASME & UNS designation	Identification used herein
SA-516 K02700	A 516 Grade 70
SB-575 N06022	Alloy 22
SB-209 A96061 T451	Al Alloy 6061



Table 5.1-5. Atomic weights in g/mole

<u>Isotope</u>	<u>MCNP ID#</u>	<u>Atomic Weight</u>
B-10	5010.50C	10.0129388
B-11	5011.56C	11.0093053
Nat. O	not used	15.9994*
O-16	8016.50C	15.994915
Nat. Fe	26000.55C	55.847*
Mo-95	42095.50C	94.905839
Tc-99	43099.50C	98.90627501**
Ru-101	44101.50C	100.905576
Rh-103	45103.50C	102.905511
Ag-109	47109.50C	108.904756
Nd-143	60143.50C	142.909779
Nd-145	60145.50C	144.912538
Sm-147	62147.50C	146.914867
Sm-149	62149.50C	148.91718
Sm-150	62150.50C	149.917276
Sm-151	62151.50C	150.919919
Sm-152	62152.50C	151.919756
Eu-151	63151.55C	150.919838
Eu-153	63153.55C	152.921242
Gd-155	64155.50C	154.922664
U-233	92233.50C	233.039522
U-234	92234.50C	234.040904
U-235	92235.50C	235.043915
U-236	92236.50C	236.045637
U-238	92238.50C	238.05077
Np-237	93237.55C	237.048056
Pu-238	94238.50C	238.049511
Pu-239	94239.55C	239.052146
Pu-240	94240.50C	240.053882
Pu-241	94241.50C	241.056737
Pu-242	94242.50C	242.058725
Am-241	95241.50C	241.056714
Am-242m	95242.50C	242.059502
Am-243	95243.50C	243.061367

Table 5.1-6. Chemical compositions of WP and fuel assembly alloys modeled

Material Element	A 516 Gr. 55 carbon steel (Ref. 7.9, p. I-1)	Alloy C-22 (Ref. 7.9, p. I-3)	Aluminum Alloy 6061 (Ref. 7.19, p. 2)	SS316B6A 1.6% B (Ref. 7.9, p. I-10)	Zircaloy-4 (Ref. 7.9, p. I-16)
Fe	98.535%	3.000%	0.700%	60.445%	0.200%
<sup>10</sup> B / <sup>11</sup> B	-	-	-	0.288%/ 1.312%	-
Cr	-	22.000%	0.195%	19.000%	0.100%
Ni	-	56.000%	-	13.500%	-
Mg	-	-	1.000%	-	-
Mn	0.900%	0.500%	0.150%	2.000%	-
Mo	-	13.000%	-	2.500%	-
N	-	-	-	0.100%	-
S	0.035%	-	-	0.030%	-
Si	0.275%	0.080%	0.600%	0.750%	-
P	0.035%	-	-	0.045%	-
C	0.220%	0.010%	-	0.030%	-
O	-	-	-	-	0.120%
Cu	-	-	0.275%	-	-
Co	-	2.060%	-	-	-
W	-	3.000%	-	-	-
Ti	-	-	0.150%	-	-
Al	-	-	96.680%	-	-
V	-	0.350%	-	-	-
Zn	-	-	0.250%*	-	-
Zr	-	-	-	-	98.180%
Sn	-	-	-	-	1.400%
TOTAL	100.00%	100.00%	100.00%	100.00%	100.00%

\* Due to lack of cross-section data for Zn in the ENDF-B/V library, the wt% Zn has been conservatively lumped into that of Al, which has a smaller thermal absorption cross section than Zn (Ref. 7.10).

### 5.1.4 BWR Waste Stream Data

The commercial SNF assembly population data (burnup and enrichment) considered in this calculation is identified in Reference 7.2, and is based on the best information available. However, this information has not yet been qualified. The specific electronic data file used from Reference 7.2 is the uncompressed C1\_WSM.ZIP, with only the information on the historic and projected BWR population used for this calculation. However, since the assembly receipt time information in the data file is not being used, any of the files for scenarios C1 through C8 from Reference 7.2 could be used because the burnup and enrichment information does not change. To simplify the use of this data with the Mathcad 7 worksheet BWRcrit.mcd, the BWR quantity, burnup, and enrichment data from these data files have been summarized in the ASCII file BWR.prn. Section 8 describes the location of electronic copies of these files.

### 5.2 Calculation of Number Densities for Degraded Basket Material

Reference 7.1 (Section 5) performed geochemistry calculations for a waste package containing 21 zircaloy-clad pressurized water reactor (PWR) SNF assemblies. The results indicate that the major insoluble corrosion product remaining from degradation of the carbon steel and borated stainless steel components will be either hematite ( $\text{Fe}_2\text{O}_3$ ) or goethite ( $\text{FeOOH}$ ). The geochemistry calculations also indicate that all of the aluminum from the aluminum thermal shunts will remain as diaspore ( $\text{AlOOH}$ ). Since the BWR WP described in Section 5.1.2 contains the same materials as the PWR waste package evaluated in Reference 7.1, and the BWR fuel assemblies being evaluated are also zircaloy clad, the above geochemistry characteristics are considered applicable to the BWR WP being evaluated.

In all cases, the components will increase in volume as they degrade due to the lower density of the corrosion products compared to the original material. Using the component volumes in Section 5.1.2 and the densities in Section 5.1.3 indicates that fully degraded aluminum thermal shunts will produce  $0.155 \text{ m}^3$  of  $\text{AlOOH}$ . Full degradation of the carbon steel and borated stainless steel components will produce  $2.266 \text{ m}^3$  of  $\text{Fe}_2\text{O}_3$  or  $3.099 \text{ m}^3$  of  $\text{FeOOH}$ . Due to the presence of the zircaloy channels around each BWR assembly, these corrosion products will not be able to expand into the void space between the fuel rods. Removing the volume within the 44 BWR assembly channels from the available void space inside the package inner diameter indicates that a  $\text{Fe}_2\text{O}_3/\text{AlOOH}$  corrosion product mixture will occupy 53.86% of the remaining void space. An  $\text{FeOOH}/\text{AlOOH}$  mixture would occupy 72.39% of the void space outside of the assembly channels. Since the waste package is assumed to be flooded for these cases (see Assumption 3.3), the remaining void space is considered to be filled with water. Number densities are calculated for the above corrosion product and water mixtures by dividing the moles of each element per WP by the void space they occupy and multiplying by Avogadro's Number ( $0.602252 \times 10^{24}$  atoms/mole). These volume and number density calculations are performed in the VolMass sheet of the Excel 97 workbook "BWRcrit.xls" (see Attachment III or Section 8).

As the corrosion product forms, there are two possibilities for its physical location within the waste package. In one case, the weight of the assemblies may force the corrosion product out from between the horizontal portions of the channel, leaving no vertical gap between assemblies once the basket has collapsed. However, forcing the corrosion product out from the vertical space between the assemblies will require that the spacing between vertical columns of collapsed assemblies be maintained to

accommodate this material. In the other extreme, all of the corrosion product from degradation of the carbon steel tubes, borated stainless steel plates, and aluminum thermal shunts will remain between vertically adjacent assemblies. Considering only the expansion of the 10 mm of carbon steel and the 5 mm of borated stainless steel between each assembly indicates that the vertical separation will be 2.7 cm if  $\text{Fe}_2\text{O}_3$  is formed, and 3.7 cm if  $\text{FeOOH}$  is formed. The vertical separation between some assemblies may actually be greater than these values because of the presence of corrosion products from the aluminum thermal shunts. However, they are ignored in calculating the separation since they are not present between all assemblies. In addition, most oxides do not pack to the theoretical densities indicated in Section 5.1.3, thus providing the potential for even more separation than is indicated above. This is illustrated in Reference 7.18 (p. 10), which indicates that the porosity of tightly packed carbon steel tubesheet corrosion products that led to the denting of steam generator tubes at two Westinghouse plants was found to be between 7% and 25%. The above separation calculations are performed in the VolMass sheet of the Excel 97 workbook "BWRcrit.xls" (see Attachment III or Section 8).

The boron in the borated stainless steel is present in the form of metal boride particles. Preliminary corrosion tests have shown that these borides corrode to soluble boric oxide at a rate similar to that of the corrosion rate of the stainless steel matrix. However, due to their extremely small size (average surface area of only  $\approx 30\mu\text{m}^2$ ), the boride particles are not expected to last for more than a few hundred years after exposure (see Reference 7.13, p. 32). Therefore, boron will generally not be considered to be included in the degradation products of the fully degraded basket. However, Reference 7.17 indicates that boron may become adsorbed to aluminum and iron oxides. This adsorption occurs at a rate of  $\approx 6.5 \times 10^{-3}$  moles B/kg of aluminum oxide,  $\approx 2 \times 10^{-3}$  moles B/kg of  $\text{Fe}_2\text{O}_3$ , and  $\approx 3.7 \times 10^{-2}$  moles/kg of  $\text{FeOOH}$ . At this rate 0.87% of the original boron may be adsorbed if an  $\text{Fe}_2\text{O}_3/\text{AlOOH}$  mixture is present, and 15.79% of the original boron in the basket may be adsorbed if an  $\text{FeOOH}/\text{AlOOH}$  mixture is present. Number densities for the latter amount of boron adsorption are calculated in the same manner discussed above for the oxide mixtures. These calculations are performed in the VolMass sheet of the Excel 97 workbook "BWRcrit.xls" (see Attachment III or Section 8).

### **5.3 Calculation of Number Densities for Fuel Region**

As mentioned in Assumption 3.2, SAS2H/ORIGEN-S is used to generate the SNF compositions for the various burnup/enrichment pairs. A representative 8x8 BWR assembly is modeled, with a central water rod instead of four fuel rods in the center. The parameters chosen to represent this assembly are arbitrary, but based on the information in Ref. 7.2 and 7.4. Table 5.1-1 shows the general parameters for the assembly that determine the geometric model of the assembly. Table 5.3-1 describes the  $\text{U}^{235}$  enrichment used and the gadolinium bearing rod description for each assembly. Table 5.3-2 shows the dimensions of the nodes used to break the assembly into smaller sections so that axial effects can be modeled. Table 5.3-3 lists the moderator densities and fuel temperatures that are modeled with these axial nodes, and Table 5.3-4 lists the power for each cycle and node.

Table 5.3-1. Assembly fuel enrichment descriptions

Fuel enrichments used				Gadolinium doped rod description	
$U^{235}$	$U^{234}$	$U^{236}$	$U^{238}$	Number of gadolinium doped rods per assembly	Gadolinium enrichment in doped rods
3.5	0.030005	0.0161	96.454	8	3
4	0.03473	0.0184	95.947	10	3.5
4.5	0.03946	0.0207	95.440	12	3.5

Table 5.3-2. Node description

Node	Height (cm)
10 (Natural uranium blanket)	15.2400
9	64.1100
8	45.7200
7	45.7200
6	45.7200
5	30.4800
4	45.7200
3	30.4800
2	30.4800
1 (Natural uranium blanket)	15.2400

The following table describes the moderator densities and fuel temperatures used to describe the assembly in SAS2H. The phrase "bypass moderator density" refers to the density of the water in the bypass channel outside the assembly. The "in-channel moderator" refers to the water inside the assembly, and has a slightly higher density to account for the presence of the water rod.

Table 5.3-3. Moderator densities and fuel temperatures for all nodes and burnups (cont.)

20,000 MWd/MTU			
Node:	Bypass moderator density (g/cm <sup>3</sup> )	In-channel moderator density (g/cm <sup>3</sup> )	Average fuel temperature (K)
10	0.446	0.461	676.95
9	0.455	0.469	963.04
8	0.478	0.491	1089.27
7	0.510	0.521	1125.32
6	0.547	0.557	1152.60
5	0.592	0.599	1172.17
4	0.645	0.649	1189.35
3	0.708	0.709	1179.49
2	0.739	0.739	1047.44
1	0.739	0.739	684.15
25,000 MWd/MTU			
Node:	Bypass moderator density (g/cm <sup>3</sup> )	In-channel moderator density (g/cm <sup>3</sup> )	Average fuel temperature (K)
10	0.449	0.463	677.51
9	0.458	0.472	961.00
8	0.482	0.494	1077.24
7	0.515	0.526	1108.19
6	0.553	0.563	1128.99
5	0.599	0.606	1140.21
4	0.652	0.656	1146.84
3	0.713	0.715	1131.21
2	0.739	0.739	1014.61
1	0.739	0.739	678.31
30,000 MWd/MTU			
Node:	Bypass moderator density (g/cm <sup>3</sup> )	In-channel moderator density (g/cm <sup>3</sup> )	Average fuel temperature (K)
10	0.452	0.466	665.66
9	0.460	0.474	920.78
8	0.484	0.497	1025.38
7	0.517	0.528	1053.24
6	0.555	0.564	1071.96
5	0.600	0.607	1082.05
4	0.653	0.657	1088.02
3	0.714	0.715	1073.96
2	0.739	0.739	969.02
1	0.739	0.739	666.38

Table 5.3-3. Moderator densities and fuel temperatures for all nodes and burnups (cont.)

35,000 MWd/MTU			
Node:	Bypass moderator density (g/cm <sup>3</sup> )	In-channel moderator density (g/cm <sup>3</sup> )	Average fuel temperature (K)
10	0.447	0.462	683.44
9	0.456	0.470	981.11
8	0.480	0.493	1103.17
7	0.513	0.525	1135.67
6	0.552	0.562	1157.51
5	0.598	0.605	1169.29
4	0.651	0.656	1176.26
3	0.713	0.714	1159.85
2	0.739	0.739	1037.41
1	0.739	0.739	684.28
40,000 MWd/MTU			
Node:	Bypass moderator density (g/cm <sup>3</sup> )	In-channel moderator density (g/cm <sup>3</sup> )	Average fuel temperature (K)
10	0.450	0.464	672.78
9	0.459	0.473	944.93
8	0.483	0.495	1056.51
7	0.515	0.526	1086.23
6	0.554	0.563	1106.20
5	0.599	0.606	1116.97
4	0.652	0.657	1123.34
3	0.714	0.715	1108.33
2	0.739	0.739	996.39
1	0.739	0.739	673.54
45,000 MWd/MTU			
Node:	Bypass moderator density (g/cm <sup>3</sup> )	In-channel moderator density (g/cm <sup>3</sup> )	Average fuel temperature (K)
10	0.446	0.461	686.99
9	0.455	0.470	993.16
8	0.480	0.493	1118.69
7	0.513	0.524	1152.12
6	0.552	0.561	1174.59
5	0.598	0.605	1186.70
4	0.651	0.655	1193.87
3	0.713	0.714	1176.99
2	0.739	0.739	1051.05
1	0.739	0.739	687.85

Table 5.3-4. Nodal powers (MW) by cycle for each node and burnup

Cycle:	Node	Burnup (MWd/MTU)					
		20000	25000	30000	35000	40000	45000
1	10	0.0370	0.0376	0.0339	0.0395	0.0361	0.0406
	9	0.6038	0.6145	0.5531	0.6452	0.5899	0.6637
	8	0.5961	0.6066	0.5460	0.6370	0.5824	0.6552
	7	0.6458	0.6572	0.5915	0.6901	0.6309	0.7098
	6	0.6875	0.6997	0.6297	0.7347	0.6717	0.7556
	5	0.4851	0.4937	0.4444	0.5184	0.4740	0.5332
	4	0.7721	0.7858	0.7072	0.8251	0.7543	0.8486
	3	0.5242	0.5335	0.4802	0.5602	0.5122	0.5762
	2	0.4061	0.4133	0.3720	0.4340	0.3968	0.4464
	1	0.0472	0.0480	0.0432	0.0504	0.0461	0.0518
2	10	0.0427	0.0434	0.0391	0.0456	0.0417	0.0469
	9	0.5978	0.6081	0.5471	0.6386	0.5838	0.6568
	8	0.5411	0.5504	0.4952	0.5780	0.5284	0.5945
	7	0.5731	0.5830	0.5244	0.6121	0.5596	0.6296
	6	0.5899	0.6001	0.5399	0.6301	0.5761	0.6481
	5	0.3970	0.4039	0.3633	0.4241	0.3877	0.4362
	4	0.6104	0.6209	0.5586	0.6520	0.5961	0.6706
	3	0.4045	0.4115	0.3702	0.4321	0.3950	0.4444
	2	0.3244	0.3300	0.2968	0.3465	0.3168	0.3564
	1	0.0422	0.0429	0.0386	0.0450	0.0412	0.0463
3	10	0.0465	0.0473	0.0425	0.0496	0.0454	0.0510
	9	0.6052	0.6156	0.5540	0.6464	0.5910	0.6648
	8	0.5489	0.5583	0.5025	0.5863	0.5360	0.6030
	7	0.5803	0.5903	0.5313	0.6198	0.5667	0.6375
	6	0.6067	0.6171	0.5554	0.6480	0.5925	0.6665
	5	0.4134	0.4205	0.3785	0.4416	0.4037	0.4542
	4	0.6113	0.6218	0.5596	0.6529	0.5969	0.6715
	3	0.3768	0.3833	0.3450	0.4025	0.3679	0.4139
	2	0.2982	0.3033	0.2730	0.3185	0.2912	0.3276
	1	0.0432	0.0439	0.0395	0.0461	0.0422	0.0474
4	10	Only three cycles used for this burnup	0.0397	0.0357	0.0417	0.0381	0.0429
	9		0.5403	0.4862	0.5673	0.5186	0.5835
	8		0.4522	0.4069	0.4748	0.4341	0.4883
	7		0.4584	0.4125	0.4813	0.4401	0.4951
	6		0.4482	0.4033	0.4706	0.4302	0.4840
	5		0.2797	0.2518	0.2937	0.2685	0.3021
	4		0.3762	0.3385	0.3950	0.3611	0.4063
	3		0.2223	0.2001	0.2334	0.2134	0.2401
	2		0.1947	0.1752	0.2045	0.1869	0.2103
	1		0.0298	0.0268	0.0313	0.0286	0.0322



The top and bottom of the assembly (nodes 1 and 10) are natural uranium blankets. The Path B model in SAS2H employs the following scheme for these nodes:

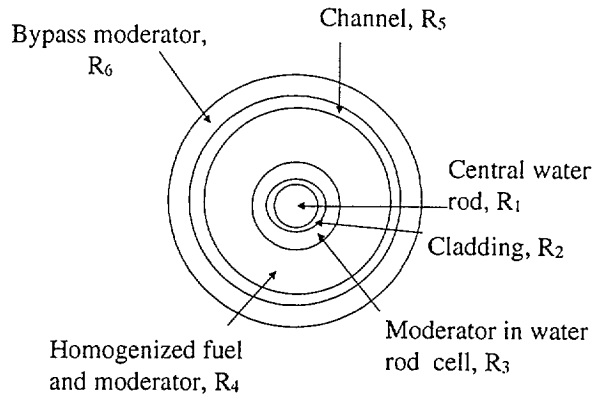

Figure 5.3-1. Path B model for top and bottom nodes

The dimensions for the model are calculated from the following formulas:

$$R_1 = \text{Radius}_{\text{Water Rod}} \quad R_2 = \text{Radius}_{\text{Water Rod Clad}}$$

$$R_3 = \sqrt{R_2^2 + \frac{((2 * \text{Pitch}_{\text{Rod}})^2 - \text{Area}_{\text{Water Rod}})}{\pi}}$$

$$R_4 = \sqrt{R_3^2 + \frac{(\text{Area}_{\text{Inside Channel}} - \text{Area}_{\text{Water Rod}} - \text{Area}_{\text{Cell Moderator}})}{\pi}}$$

$$\text{Area}_{\text{Cell Moderator}} = (2 * \text{Pitch}_{\text{Rod}})^2 - \text{Area}_{\text{Water Rod}}$$

$$\text{Area}_{\text{Inside Channel}} = \text{Inside Channel Dimension}^2$$

$$R_5 = \sqrt{R_4^2 + \frac{\text{Area}_{\text{Channel}}}{\pi}}$$

$$\text{Area}_{\text{Bypass Moderator}} = (\text{Pitch}_{\text{Assembly}}^2) - (\text{Outside}^2_{\text{Channel Dimension}})$$

$$\text{Area}_{\text{Channel}} = \text{Outside}^2_{\text{Channel Dimension}} - \text{Inside}^2_{\text{Channel Dimension}}$$

$$R_6 = \sqrt{R_5^2 + \frac{Area_{Bypass Moderator}}{\pi}}$$

For nodes 9-2, the Path B model is determined from the number of regular fuel rods per gadolinium bearing rod. The model for these nodes is a central gadolinium rod, surrounded by clad and in-cell moderator. Outside the cell is the homogenized fuel and moderator region. Surrounding this is the channel and then the bypass moderator. Because SAS2H does not permit a central rod with gadolinium to be surrounded

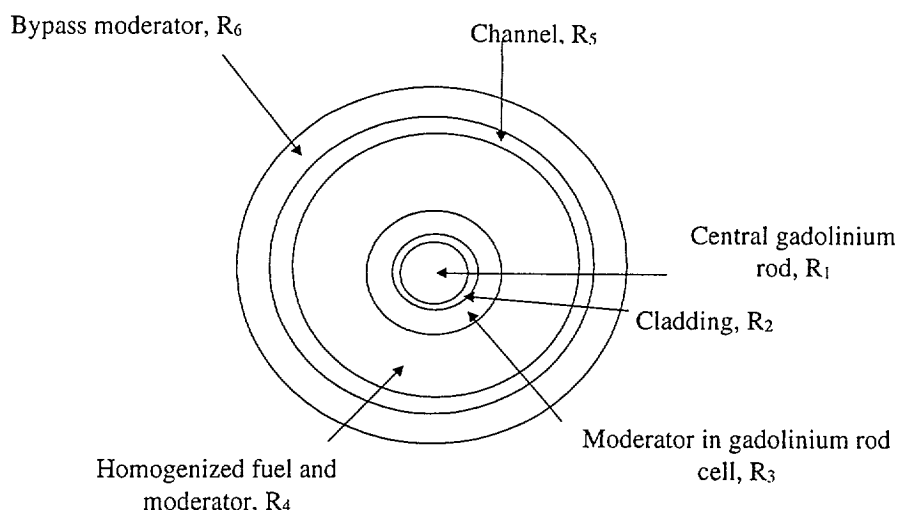

Figure 5.3-2. Path B model for nodes 2-9

by a gap, the fuel pellet is smeared to the cladding inner diameter. In addition, the in-cell moderator and the in-channel moderator also have adjusted densities to account for the full density water rod. Figure 5.3-2 shows the Path B model, and the following formulas are used for calculating the dimensions for the model. The first three radii describe the central gadolinium bearing fuel rod, and the moderator in the 'cell' that surrounds it (defined by the rod pitch):

$$R_1 = Radius_{Inside Clad}$$

$$R_2 = Radius_{Outside Clad}$$

$$R_3 = \sqrt{\frac{Rod Pitch^2}{\pi}}$$

The next zone in the model is the homogenized fuel and moderator region. This is determined by calculating the amount of in-channel moderator (including the water rod) and the amount of fuel that each gadolinium (Gd) bearing rod sees.

$$In - Channel Moderator_{Per Gd Rod} = \frac{(Area_{Inside Channel} - 60 * \pi * Radius_{Outside Clad}^2)}{\#Rods_{Gd}}$$

$$Area_{Fuel Per Gd Rod} = \left( \frac{\# Fuel Rods}{Gd Rod} \right) * \pi * Radius_{Outside Clad}^2$$

$$Area_{Homogenized Zone} = In - Channel Moderator_{Per Gd Rod} - Area_{Cell Moderator} + Area_{Fuel Per Gd Rod}$$

$$R_4 = \sqrt{\frac{Area_{Homogenized Zone}}{\pi} + R_3^2}$$

The fifth zone corresponds to the amount of the channel wall per gadolinium bearing rod:

$$R_5 = \sqrt{\frac{\left( \frac{Fuel Cells Per Gd Rod + 1}{60} \right) * (Channel Outer Area - Channel Inner Area)}{\pi} + R_4^2}$$

Finally, the last zone refers to the amount of assembly bypass moderator that the gadolinium bearing rod sees:

$$R_6 = \sqrt{R_5^2 + \left( \frac{Fuel Rods Per Gd Rod + 1}{60} * Area_{Channel} \right) / \pi}$$

The decay out to 1 million years is run as a separate case from the SAS2H burnup calculation. The decay case is a stand-alone ORIGEN-S problem which utilizes the output from SAS2H and decays to a number of specified times. However, both sequences are run using a single input file for each burnup/enrichment case. The input files are echoed in the output files, which have an "out" extension. At the end of each SAS2H/ORIGEN-S run, the gram concentrations for the principal isotopes are copied from the SAS2H/ORIGEN-S output into a summary file (\*.SUM) using the UNIX "awk" command.

The grams/assembly output for each time step is used to calculate the number density of each principal isotope (see Assumption 3.1). The burnup/enrichment pair number densities for the principal isotopes are calculated from the SAS2H summary files using a short BASIC software routine, AMIGO10B.BAS, which also automatically places them into the appropriate location in an MCNP4B2 input file template (see Attachment II for the source code). The AMIGO10B number density calculations for each node are performed using the following equation:

$$N_i = \frac{4m_i N_A}{\pi d^2 n l M_i}$$

where:  $N_A$  is Avogadro's Number -  $0.602252 \times 10^{24}$  atoms/mole,  
 $M_i$  is the gram atomic weight of isotope  $i$ ,  
 $m_i$  is the gram concentration of isotope  $i$  in the fuel node,  
 $d$  is the outer diameter of the fuel pellet in cm,  
 $l$  is the length of the node in cm, and  
 $n$  is the number of fuel rods per assembly.

The units of the resulting number density are in atoms/cm<sup>3</sup>. The required units for subsequent use are atoms/b-cm where 1 barn equals  $10^{-24}$  cm<sup>2</sup>. The calculation in AMIGO10B drops the  $10^{24}$  from Avogadro's Number to account for the conversion. The concentration of oxygen in each node is not provided in the SAS2H/ORIGEN-S output, but is calculated by AMIGO10B based on the initial assembly uranium loading given in Table 5.1-1 and the ratio of the node height to the total active fuel length. The number densities for each of the principal isotopes plus oxygen are then summed to get a total number density for the each fuel node.

AMIGO10B creates MCNP4B2 inputs by searching the lines of a user-supplied template for the mnemonics "FUELTOT##" and "FUELNUM##". When found in the template file, FUELTOT## is replaced with the total number density for node ## (where ## is a value from 01 to 10), and FUELNUM## is replaced with the MCNP ID#s and number densities of the principal isotopes for node ##. An input file is created for each decay time available from the SAS2H summary file that is within the user-specified range.

#### **5.4 MCNP4B2 Model Description**

The purpose of this section is to describe the MCNP4B2 cases needed to evaluate the  $k_{\text{eff}}$  of the 44 BWR waste package with a fully degraded basket. The waste package is modeled in MCNP by explicitly modeling  $\frac{1}{2}$  of the package and then using a reflective plane to represent the entire package. The composition and dimensions of the containment barriers and basket components are modeled explicitly using the information in Section 5.1.2. Each GE 8x8 fuel assembly is treated as a heterogeneous system with the fuel rods and control rod guide tubes modeled explicitly using the information contained in Section 5.1.1. The fuel rods are conservatively modeled with water in the gap region. The corrosion product/water mixtures are uniformly distributed within the internal WP void space, except for that void space within the assembly channels. As indicated in Section 5.2, the void space within the assembly channels is modeled as containing only pure, full density water.

Figure 5.4-1 shows a detailed view of the MCNP4B2 fuel assembly model common to all of the WP models containing intact fuel. Figure 5.4-2 shows the details of the MCNP4B2 model for the base case degraded 44 BWR WP with the basket completely degraded and collapsed such that there is no vertical spacing between assemblies. Figure 5.4-3 shows the details of the MCNP4B2 model for a variation on the base case configuration with 2.7 cm vertical spacing between assemblies.

```
08/17/98 15:43:20
Degraded BWR-44 Waste Package
(44bd00.irp)

probid = 08/17/98 15:33:22
basis:
( 1.000000, .000000, .000000)
( .000000, 1.000000, .000000)
origin:
( -8.82, 2.22, 100.00)
extent = ( 7.49, 7.49)
```

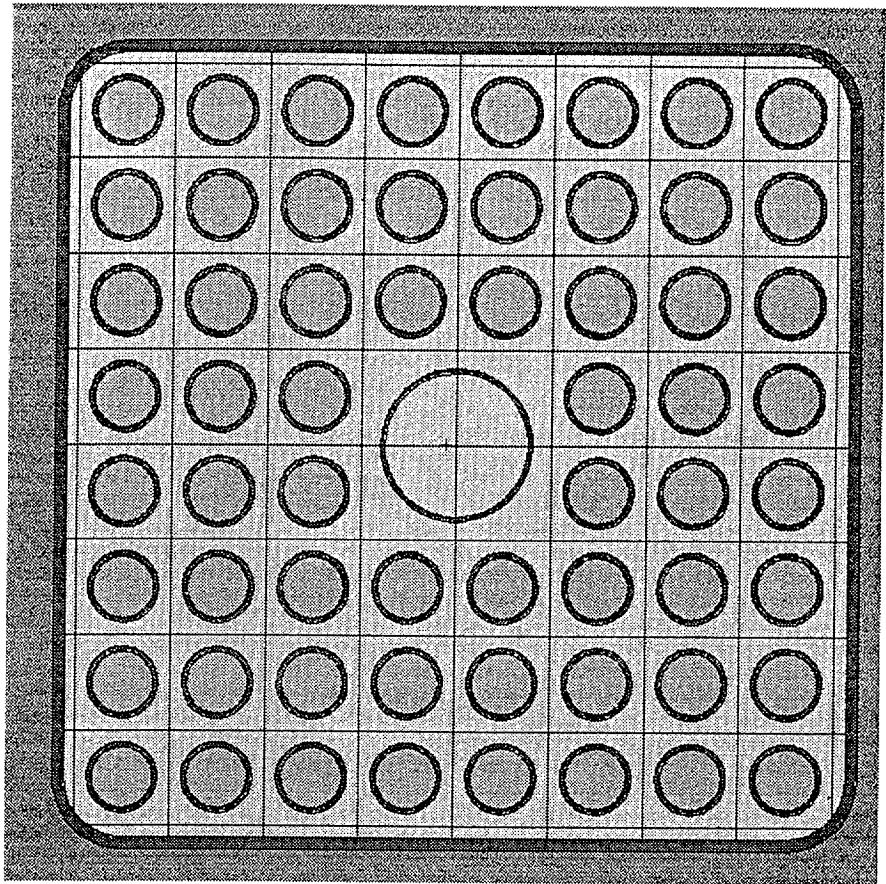

Figure 5.4-1. GE 8x8 BWR fuel assembly

```
08/17/98 17:04:03  
Degraded BWR-44 Waste Package  
(44bd00.1xp)  
  
probid = 08/17/98 16:07:53  
basis:  
( 1.000000, .000000, .000000)  
( .000000, 1.000000, .000000)  
origin:  
( .00, .00, 100.00)  
extent = ( 100.00, 100.00)
```

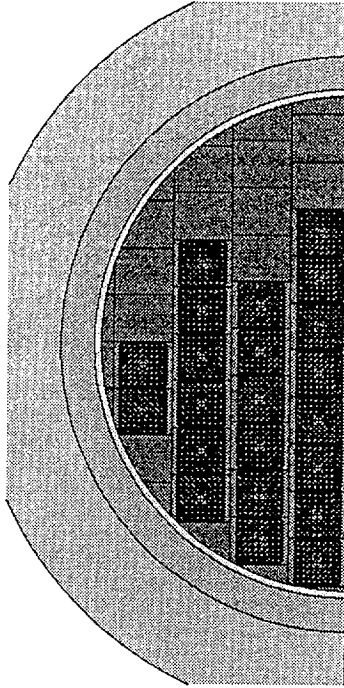

Figure 5.4-2. 44 BWR WP with fully degraded basket and uniformly distributed corrosion products in volume outside of fuel channels (base case)

```
08/17/98 17:32:16  
Degraded BWR-44 Waste Package  
(44bd00.1xp)  
  
probid = 08/17/98 17:26:57  
basis:  
( 1.000000, .000000, .000000)  
( .000000, 1.000000, .000000)  
origin:  
( .00, .00, 100.00)  
extent = ( 100.00, 100.00)
```

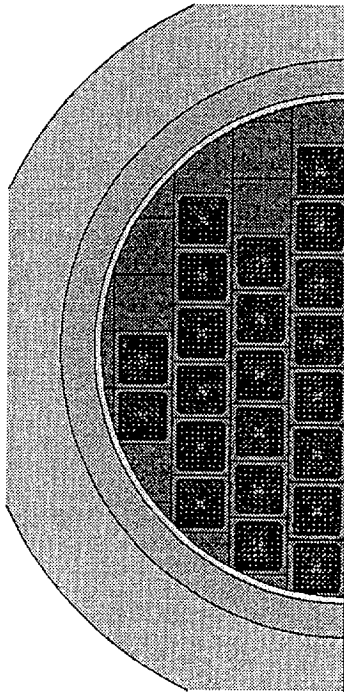

Figure 5.4-3. 44 BWR WP with fully degraded basket and 2.7 cm vertical separation between assemblies

## 6. RESULTS

Since unqualified inputs were used in the development of the results presented in this section, they should be considered TBV (to be verified). This document will not directly support any construction, fabrication or procurement activity, and therefore, the inputs and results are not required to be procedurally controlled as TBV. However, use of any data from this analysis for input into documents supporting procurement, fabrication, or construction is required to be controlled as TBV in accordance with appropriate procedures.

### 6.1 Criticality Calculations of Degraded Internal Configurations

Criticality calculations are performed using MCNP4B2 for the base case degraded configuration for BWR fuel enrichments of 3.5%, 4%, and 4.5%. Generally, only those burnups yielding  $k_{eff}$  values in the range of 0.90 to 1.0 are considered. For BWR SNF with an initial  $^{235}\text{U}$  enrichment of 4.5%, and a burnup of 35 GWd/MTU, decay times from 1000 years to 250,000 years are evaluated. The  $k_{eff}$  value  $\pm 2\sigma$  and the average energy of the neutron causing fission (AENCF) for these times are given in Table 6.1-1, and the  $k_{eff}$  values are plotted in Figure 6.1-1. The peak  $k_{eff}$  occurs at 25,000 years for this case. For the remainder of the burnup/enrichment combinations,  $k_{eff}$  calculations are only performed for times between 12,000 years and 35,000 years, to allow the peak  $k_{eff}$  to be identified. These results are also reported in Table 6.1-1.

Table 6.1-1.  $k_{eff}$  results for base case 44 BWR WP with fully degraded basket

Enrichment (%)	Burnup (GWd)	Time (years)	$k_{eff}$	$\pm 2\sigma$	AENCF (MeV)	MCNP Output Filename
3.50	20	12,000	1.0053	0.0025	0.1649	20b35nc.O
3.50	20	14,000	1.0101	0.0025	0.1650	20b35nd.O
3.50	20	18,000	1.0082	0.0026	0.1644	20b35ne.O
3.50	20	25,000	1.0069	0.0028	0.1620	20b35nf.O
3.50	20	35,000	1.0028	0.0024	0.1603	20b35ng.O
3.50	25	12,000	0.9553	0.0027	0.1770	25b35nc.O
3.50	25	18,000	0.9585	0.0026	0.1730	25b35ne.O
3.50	25	25,000	0.9556	0.0034	0.1723	25b35nf.O
3.50	25	35,000	0.9519	0.0028	0.1698	25b35ng.O
3.50	30	12,000	0.9167	0.0026	0.1842	30b35nc.O
3.50	30	14,000	0.9120	0.0032	0.1845	30b35nd.O
3.50	30	18,000	0.9134	0.0028	0.1802	30b35ne.O
3.50	30	25,000	0.9141	0.0028	0.1797	30b35nf.O
3.50	30	35,000	0.9074	0.0029	0.1793	30b35ng.O
4.00	20	12,000	1.0494	0.0026	0.1592	20b40nc.O
4.00	20	14,000	1.0509	0.0028	0.1595	20b40nd.O
4.00	20	18,000	1.0461	0.0025	0.1573	20b40ne.O
4.00	20	25,000	1.0503	0.0026	0.1551	20b40nf.O
4.00	20	35,000	1.0439	0.0027	0.1554	20b40ng.O

Table 6.1-1.  $k_{eff}$  results for base case 44 BWR WP with fully degraded basket

Enrichment (%)	Burnup (GWd)	Time (years)	$k_{eff}$	$\pm 2\sigma$	AENCF (MeV)	MCNP Output Filename
4.00	25	12,000	1.0028	0.0026	0.1654	25b40nc.O
4.00	25	14,000	1.0015	0.0034	0.1667	25b40nd.O
4.00	25	18,000	1.0049	0.0028	0.1653	25b40ne.O
4.00	25	25,000	1.0033	0.0034	0.1639	25b40nf.O
4.00	25	35,000	1.0018	0.0026	0.1633	25b40ng.O
4.00	30	12,000	0.9606	0.0028	0.1738	30b40nc.O
4.00	30	14,000	0.9674	0.0025	0.1739	30b40nd.O
4.00	30	18,000	0.9622	0.0024	0.1709	30b40ne.O
4.00	30	25,000	0.9633	0.0028	0.1710	30b40nf.O
4.00	30	35,000	0.9610	0.0028	0.1691	30b40ng.O
4.00	35	12,000	0.9256	0.0028	0.1815	35b40nc.O
4.00	35	14,000	0.9284	0.0024	0.1807	35b40nd.O
4.00	35	18,000	0.9294	0.0023	0.1775	35b40ne.O
4.00	35	25,000	0.9246	0.0027	0.1773	35b40nf.O
4.00	35	35,000	0.9214	0.0029	0.1760	35b40ng.O
4.00	40	12,000	0.8883	0.0026	0.1885	40b40nc.O
4.00	40	14,000	0.8861	0.0027	0.1885	40b40nd.O
4.00	40	18,000	0.8887	0.0024	0.1866	40b40ne.O
4.00	40	25,000	0.8869	0.0027	0.1843	40b40nf.O
4.00	40	35,000	0.8815	0.0027	0.1832	40b40ng.O
4.50	25	18,000	1.0431	0.0026	0.1589	25b45ne.O
4.50	25	25,000	1.0440	0.0028	0.1576	25b45nf.O
4.50	25	35,000	1.0397	0.0025	0.1573	25b45ng.O
4.50	30	10,000	1.0028	0.0028	0.1663	30b45nb.O
4.50	30	12,000	1.0049	0.0029	0.1676	30b45nc.O
4.50	30	14,000	1.0053	0.0029	0.1668	30b45nd.O
4.50	30	18,000	1.0058	0.0028	0.1654	30b45ne.O
4.50	30	25,000	1.0076	0.0029	0.1639	30b45nf.O
4.50	30	35,000	1.0057	0.0029	0.1621	30b45ng.O
4.50	35	1,000	0.9518	0.0030	0.1806	35b45nx.O
4.50	35	2,000	0.9592	0.0027	0.1794	35b45ny.O
4.50	35	4,000	0.9630	0.0026	0.1788	35b45nz.O
4.50	35	8,000	0.9652	0.0030	0.1747	35b45na.O
4.50	35	10,000	0.9677	0.0032	0.1744	35b45nb.O
4.50	35	12,000	0.9696	0.0028	0.1727	35b45nc.O
4.50	35	14,000	0.9667	0.0031	0.1730	35b45nd.O
4.50	35	18,000	0.9693	0.0031	0.1702	35b45ne.O
4.50	35	25,000	0.9709	0.0031	0.1708	35b45nf.O
4.50	35	35,000	0.9689	0.0029	0.1675	35b45ng.O
4.50	35	45,000	0.9621	0.0025	0.1670	35b45nh.O
4.50	35	100,000	0.9506	0.0025	0.1646	35b45ni.O
4.50	35	250,000	0.9502	0.0029	0.1633	35b45nj.O



Table 6.1-1.  $k_{eff}$  results for base case 44 BWR WP with fully degraded basket

Enrichment (%)	Burnup (GWd)	Time (years)	$k_{eff}$	$\pm 2\sigma$	AENCF (MeV)	MCNP Output Filename
4.50	40	18,000	0.9369	0.0023	0.1763	40b45ne.O
4.50	40	25,000	0.9331	0.0030	0.1768	40b45nf.O
4.50	40	35,000	0.9330	0.0028	0.1723	40b45ng.O
4.50	45	18,000	0.8998	0.0023	0.1841	45b45ne.O
4.50	45	25,000	0.8991	0.0025	0.1820	45b45nf.O
4.50	45	35,000	0.8940	0.0024	0.1813	45b45ng.O

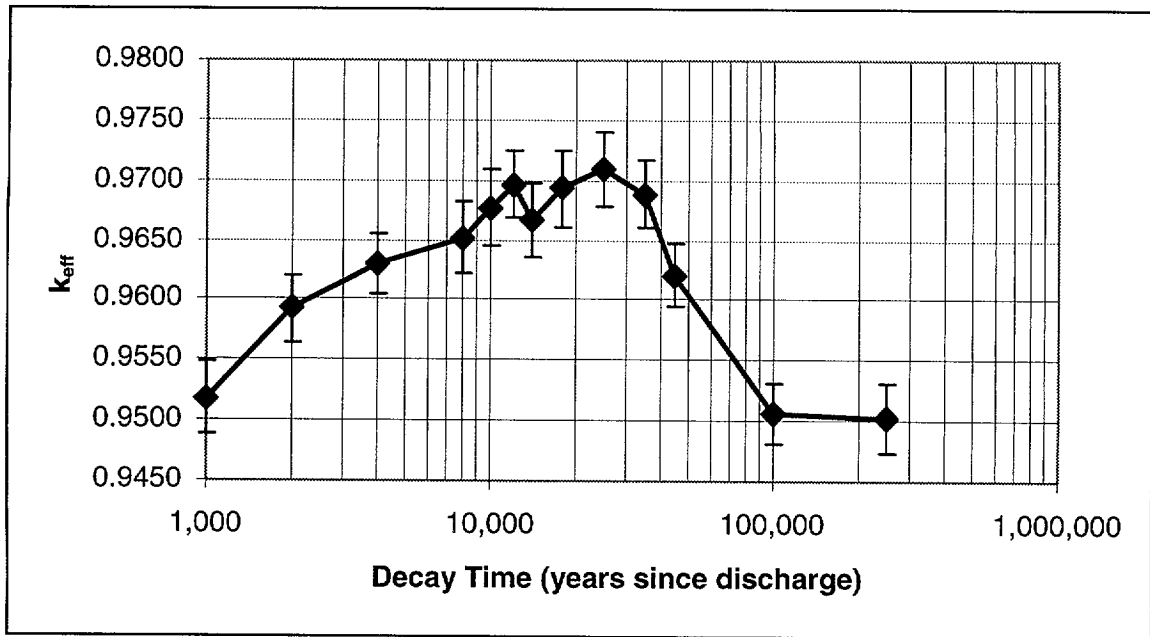

Figure 6.1-1. Time effects on  $k_{eff}$  of fully degraded 44 BWR WP basket containing 4.5% initial enrichment, 35 GWd/MTU SNF

Several variations from the base case configuration are also evaluated for the 4.5% initial  $^{235}\text{U}$  enrichment with 35 GWd/MTU burnup at a decay time of 25,000 years. These variations include the changes in corrosion product mixture composition, vertical spacing between assemblies, and potential boron adsorption amounts discussed in Section 5.2. The  $k_{eff}$  values  $\pm 2\sigma$ , the AENCF, and the  $\Delta k_{eff}/k_{eff}$  calculated from the base case  $k_{eff}$  value are given in Table 6.1-2.

Table 6.1-2. Effects of variations from the base case configuration for 4.5% initial enrichment, 35 GWd/MTU SNF at 25,000 years

Case	MCNP File	$k_{eff}$	$\pm 2\sigma$	AENCF (MeV)	$\Delta k_{eff}/k_{eff}$
Base case - no vertical separation and Fe <sub>2</sub> O <sub>3</sub> /AlOOH	35b45nf.O	0.9709	0.0031	0.1708	0.0000
2.7 cm vertical separation and Fe <sub>2</sub> O <sub>3</sub> /AlOOH	CASE2F.O	0.8858	0.0029	0.1692	-0.0876
2.7 cm vertical separation and FeOOH/AlOOH	CASE3F.O	0.8691	0.0027	0.1688	-0.1049
3.7 cm vertical separation and FeOOH/AlOOH	CASE4F.O	0.8327	0.0026	0.1705	-0.1424
3.7 cm vertical separation and FeOOH/AlOOH with 15% of <sup>10</sup> B adsorbed	CASE5F.O	0.7660	0.0022	0.1871	-0.2111

**6.2 Regression Analysis and Waste Stream Coverage Estimates**

The peak  $k_{eff}$  values for each of the burnup/enrichment combinations evaluated for the base case model are provided in Table 6.2-1 along with the times at which they occurred.

Table 6.2-1. Base case peak  $k_{eff}$  values and times for various enrichments and burnups

Enrichment	Burnup (GWd)	Time (years)	Peak $k_{eff}$	$2\sigma$
3.5	25	18,000	0.9585	0.0026
3.5	20	14,000	1.0101	0.0025
3.5	30	12,000	0.9167	0.0028
4	20	14,000	1.0509	0.0028
4	25	18,000	1.0049	0.0028
4	30	14,000	0.9674	0.0025
4	35	18,000	0.9294	0.0023
4	40	18,000	0.8887	0.0024
4.5	25	25,000	1.0440	0.0028
4.5	30	25,000	1.0076	0.0029
4.5	35	25,000	0.9709	0.0031
4.5	40	18,000	0.9369	0.0023
4.5	45	18,000	0.8998	0.0023

A multivariate regression is performed for the values in Table 6.2-1 to obtain a fit for peak  $k_{eff}$  of the base case configuration as a function of assembly burnup and initial enrichment. The regression is performed in the Regression sheet of the Excel 97 workbook, "BWRcrit.xls" (see Section 8 and Attachment III), using the Excel regression tool. The form of the regression equation in both cases is as

follows:

$$k_{eff} = C_0 + C_1e + C_2b$$

where  $b$  is burnup in GWd/MTU, and  $e$  is initial enrichment in wt%. The resulting coefficients for regression are provided in Table 6.2-2. The adjusted R square value of 0.99 indicates that this regression equation provides a very good fit to the  $k_{eff}$  data in the 3.5% to 4.5% enrichment range. It is expected that this fit will also be applicable to lower enrichments based on the results of PWR loading curve calculations (Ref. 7.11, Section 6) which indicate a linear relationship between burnup and enrichment for a given  $k_{eff}$  value

Table 6.2-2. Regression results for base case peak  $k_{eff}$  as a function of burnup and enrichment

$C_0$	0.850736
$C_1$	0.087294
$C_2$	-0.007751
Adjusted R Square	0.990448
Standard Error	0.005163
Observations	13

Next, the regression function is utilized to estimate the fraction of the BWR waste stream which would exceed a given peak  $k_{eff}$  value in the base case configuration. Figure 6.2-1 uses the regression to show the burnup/enrichment combinations which yield  $k_{eff}$  values of 0.93 and 0.98 for the base case configuration. These are plotted against the distribution of the historical and projected burnups and enrichments for the BWR waste stream, based on the information provided in Section 5.1.4. This plot is produced in the Waste Stream sheet of the Excel 97 workbook "BWRcrit.xls" (see Section 8 and Attachment III).

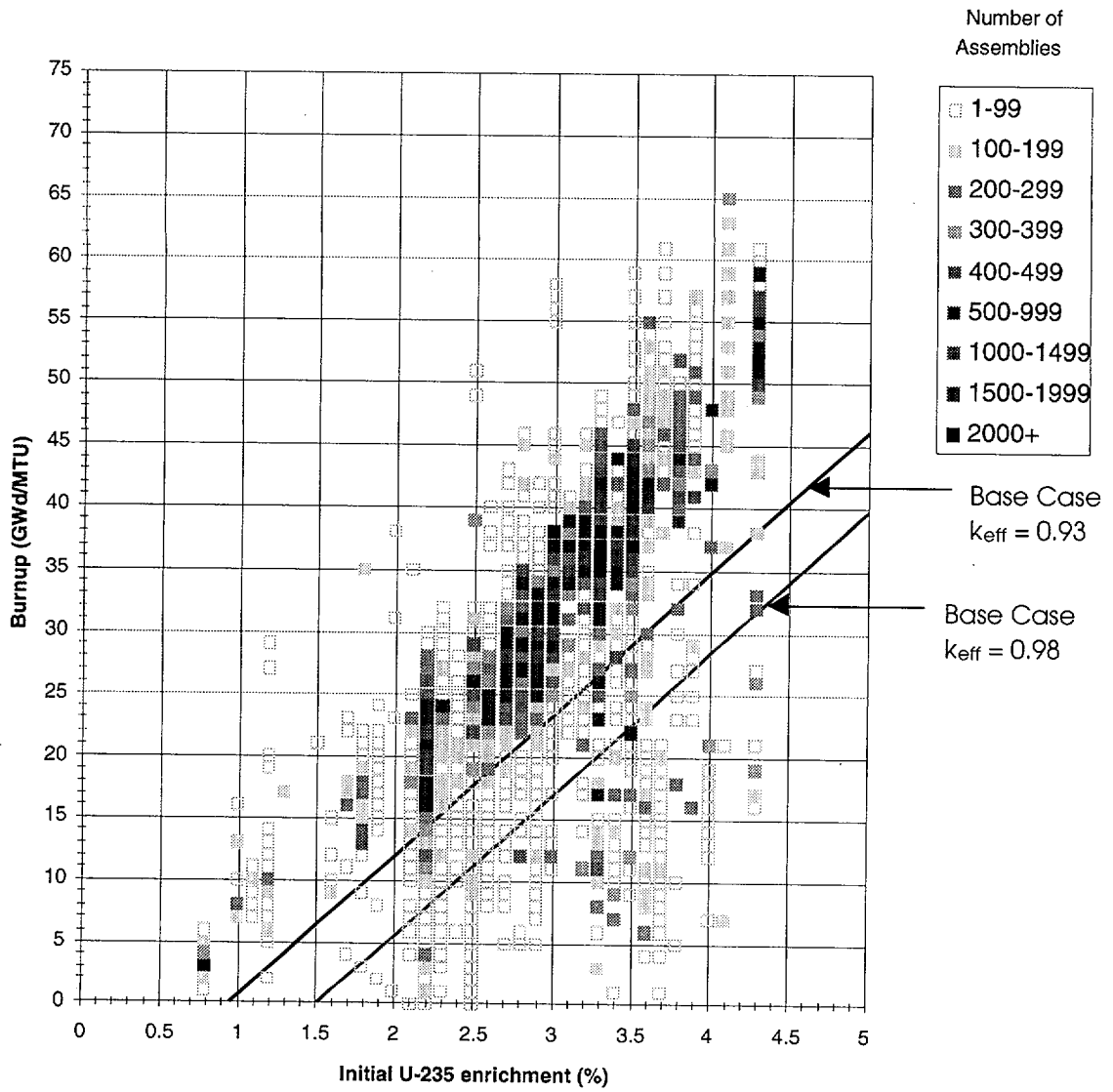

Figure 6.2-1. Burnup/enrichment combinations yielding peak k<sub>eff</sub> values of 0.93 and 0.98 for the base case configuration plotted against the BWR waste stream

Finally, the BWR waste stream burnup, enrichment, and quantity information contained in the BWR.PRN file discussed in Section 5.1.4 is used, along with the regression developed above, to estimate the percentage of the BWR waste stream which would exceed a given  $k_{\text{eff}}$  value for various degraded configurations. The results are provided in Table 6.2-3. Estimated waste stream coverage for variations from the base case configuration are estimated by multiplying the regression result by  $(1+\Delta k_{\text{eff}}/k_{\text{eff}})$ , where  $\Delta k_{\text{eff}}/k_{\text{eff}}$  is obtained from Table 6.1-2 for a given variation. These calculations are performed in the Mathcad 7 sheet BWRcrit.mcd (see Section 8 and Attachment IV).

Table 6.2-3. Percentage of the BWR waste stream which would exceed a given  $k_{\text{eff}}$  value for various degraded configurations

Case	% of BWR assys. with $k_{\text{eff}} \geq 0.93$	% of BWR assys. with $k_{\text{eff}} \geq 0.98$
Base case	11.2%	6.90%
2.7 cm vertical separation	4.20%	1.20%
2.7 cm vertical separation with FeOOH	2.90%	0.44%
3.7 cm vertical separation with FeOOH	0.91%	0.12%
3.7 cm vertical separation with FeOOH and 15% of $^{10}\text{B}$ adsorbed	0.00%	0.00%

**7. REFERENCES**

- 7.1 *EQ6 Calculations for Chemical Degradation of PWR Spent Fuel Waste Packages*, Document Identifier Number (DI#): BBA000000-01717-0210-00009 REV 00. Civilian Radioactive Waste Management System (CRWMS) Management and Operations (M&O). MOL.19980701.0483.
- 7.2 *Input Files and Models Used in the Waste Quantity, Mix and Throughput Study*, Interoffice Correspondance (IOC#) VA.SAIMF.03/97.007, CRWMS M&O. MOL.19970811.1264.
- 7.3 Roberts, W. L., Rapp, Jr., G. R., Weber, J., *Encyclopedia of Minerals*, Van Nostrand Reinhold Company, 1974. TIC 238571.
- 7.4 *Summary Report of Commercial Reactor Criticality Data for Quad Cities Unit 2*, DI#: BBA000000-01717-5705-00096 REV 00, CRWMS M&O. MOL.19980730.0509.
- 7.5 *Software Qualification Report for the SCALE Modular Code System Version 4.3*, DI#: 30011-2002 REV 01, CRWMS M&O. MOL.19970731.0884.
- 7.6 *Software Qualification Report for MCNP V4B2LV*, DI#: 30033-2003 REV 01, CRWMS M&O. MOL.19980622.0636.
- 7.7 *Waste Package Materials Selection Analysis*, DI#: BBA000000-01717-0200-00020 REV 01, CRWMS M&O. MOL.19980324.0242.
- 7.8 American Society of Mechanical Engineers, 1995. Boiler and Pressure Vessel Code Section II. Code Table NF-2. Typical Physical Properties of Materials. TIC 238572.
- 7.9 *Material Compositions and Number Densities for Neutronics Calculations*, DI#: BBA000000-01717-0200-00002 REV 00, CRWMS M&O. MOL.19960624.0023.
- 7.10 *Nuclides and Isotopes*, 14th Edition, General Electric Company, 1989. TIC 201637.
- 7.11 *Principle Isotope Burnup Credit Loading Curves for the 21 PWR Waste Package*, DI#: BBA000000-01717-0210-00008 REV 00, CRWMS M&O. MOL.19980825.0003.
- 7.12 *CRC Handbook of Chemistry and Physics*, 66th Edition, CRC Press, 1985. TIC 216054.
- 7.13 *Criticality Evaluation of Degraded Internal Configurations for the PWR AUCF Waste Package Designs*, DI#: BBA000000-01717-0200-00056 REV 00, CRWMS M&O. MOL.19971231.0251.
- 7.14 *MCNP 4B – Monte Carlo N-Partical Transport Code System, Version 4B*, CCC-660, Oak Ridge National Laboratory, April 1997. MOL.19980624.0328.

- 7.15 Knief, R. A., *Nuclear Criticality Safety - Theory and Practice*, American Nuclear Society, La Grange Park, IL, 1993. TIC 103761.
- 7.16 *Disposal Criticality Analysis Methodology Technical Report*, DI#: B00000000-01717-5705-00020 REV 01, CRWMS M&O. MOL.19980108.0700.
- 7.17 Goldberg, S., Glaubig, R. A., "Boron Adsorption on Aluminum and Iron Oxide Minerals", *Soil Sciences Society of America Journal*, Volume 49, pp. 1374-1379, 1985. TIC 238169.
- 7.18 *Radiation Effects on Tube Denting in the Steam Generators of Pressurized Water Reactors*, UCRL-52892, Lawrence Livermore National Laboratory, February 1980. NNA.19891120.0009.
- 7.19 *Standard Specification for Aluminum-Alloy 6061-T6 Standard Structural Profiles*, ASTM B308/B308M-96, American Society for Testing and Materials. TIC 238704.
- 7.20 *Electronic Files for BBA000000-01717-0210-00020 REV 00*, Colorado Trakker tape, CRWMS M&O. MOL.19980825.0007.
- 7.21 *SCALE 4.3, RSIC Computer Code Collection, CCC-545*, Oak Ridge National Laboratory, October 1995, also known as NUREG/CR-0200, Revision 5. TIC 235920.

## 8. ATTACHMENTS

Attachments to this document are listed in Table 8-1 below.

Table 8-1. List of Attachments

Attachment Number	Description	Size
I	44 BWR WP sketch	1 p.
II	AMIGO10B.bas QBASIC source code	5 pp.
III	Hardcopy of Excel 97 spreadsheet BWRcrit.xls	29 pp.
IV	Hardcopy of Mathcad 7 sheet BWRcrit.mcd	1 p.

The following supporting documents are in electronic form on a Colorado Trakker<sup>®</sup> tape (Ref. 7.20). Each file is identified by its name, size (in bytes), and the date and time of last access. Note that for files transferred from the HP to the PC, the date and time will reflect the time of transfer. The actual date and time of run completion can be found in the file.

DOS Filename	byte size	date	time	WIN95 filename
20B35N01 OUT	5,011,284	08-18-98	2:29p	20b35n01.out
20B35N10 OUT	4,997,111	08-18-98	2:30p	20b35n10.out
20B40N01 OUT	3,577,256	08-18-98	2:42p	20b40n01.out
20B40N10 OUT	3,563,083	08-18-98	2:43p	20b40n10.out
25B35N01 OUT	5,961,065	08-18-98	2:31p	25b35n01.out
25B35N10 OUT	5,949,662	08-18-98	2:33p	25b35n10.out
25B40N01 OUT	4,527,037	08-18-98	2:45p	25b40n01.out
25B40N10 OUT	4,515,634	08-18-98	2:47p	25b40n10.out
30B35N01 OUT	5,967,918	08-18-98	2:37p	30b35n01.out
30B35N10 OUT	5,953,793	08-18-98	2:37p	30b35n10.out
30B40N01 OUT	4,533,890	08-18-98	2:47p	30b40n01.out
30B40N10 OUT	4,519,765	08-18-98	2:49p	30b40n10.out
20B35N02 OUT	5,160,642	08-18-98	2:29p	20b35n02.out
20B35N03 OUT	5,165,354	08-18-98	2:29p	20b35n03.out
35B40N01 OUT	4,538,541	08-18-98	3:00p	35b40n01.out
35B40N10 OUT	4,525,067	08-18-98	2:53p	35b40n10.out
20B35N04 OUT	5,167,612	08-18-98	2:29p	20b35n04.out
20B35N05 OUT	5,165,259	08-18-98	2:29p	20b35n05.out
40B40N01 OUT	4,540,668	08-18-98	2:53p	40b40n01.out
40B40N10 OUT	4,526,108	08-18-98	2:55p	40b40n10.out
20B35N06 OUT	5,167,298	08-18-98	2:29p	20b35n06.out
20B35N07 OUT	5,166,888	08-18-98	2:30p	20b35n07.out
20B35N08 OUT	5,165,699	08-18-98	2:30p	20b35n08.out
20B35N09 OUT	5,155,301	08-18-98	2:30p	20b35n09.out
25B35N02 OUT	6,157,696	08-18-98	2:31p	25b35n02.out
25B35N03 OUT	6,164,315	08-18-98	2:31p	25b35n03.out
25B35N04 OUT	6,168,211	08-18-98	2:32p	25b35n04.out
25B35N05 OUT	6,165,268	08-18-98	2:32p	25b35n05.out
25B35N06 OUT	6,168,469	08-18-98	2:32p	25b35n06.out
25B35N07 OUT	6,168,302	08-18-98	2:32p	25b35n07.out
25B35N08 OUT	6,167,263	08-18-98	2:32p	25b35n08.out
25B35N09 OUT	6,154,629	08-18-98	2:33p	25b35n09.out
30B35N02 OUT	6,160,533	08-18-98	2:33p	30b35n02.out
30B35N03 OUT	6,173,968	08-18-98	2:34p	30b35n03.out
30B35N04 OUT	6,176,367	08-18-98	2:34p	30b35n04.out
30B35N05 OUT	6,169,035	08-18-98	2:34p	30b35n05.out
30B35N06 OUT	6,170,734	08-18-98	2:34p	30b35n06.out
30B35N07 OUT	6,170,339	08-18-98	2:34p	30b35n07.out
30B35N08 OUT	6,169,751	08-18-98	2:35p	30b35n08.out
30B35N09 OUT	6,158,752	08-18-98	2:35p	30b35n09.out
20B40N02 OUT	5,147,664	08-18-98	2:43p	20b40n02.out
20B40N03 OUT	5,151,799	08-18-98	2:43p	20b40n03.out
20B40N04 OUT	5,154,223	08-18-98	2:43p	20b40n04.out
20B40N05 OUT	5,152,139	08-18-98	2:43p	20b40n05.out
20B40N06 OUT	5,153,866	08-18-98	2:43p	20b40n06.out
20B40N07 OUT	5,153,663	08-18-98	2:43p	20b40n07.out
20B40N08 OUT	5,152,619	08-18-98	2:43p	20b40n08.out
20B40N09 OUT	5,142,116	08-18-98	2:43p	20b40n09.out
25B40N02 OUT	6,141,151	08-18-98	2:45p	25b40n02.out
25B40N03 OUT	6,147,472	08-18-98	2:45p	25b40n03.out
25B40N04 OUT	6,152,490	08-18-98	2:45p	25b40n04.out
25B40N05 OUT	6,149,443	08-18-98	2:46p	25b40n05.out
25B40N06 OUT	6,152,750	08-18-98	2:46p	25b40n06.out
25B40N07 OUT	6,152,479	08-18-98	2:46p	25b40n07.out



25B40N08	OUT	6,151,666	08-18-98	2:46p	25b40n08.out
25B40N09	OUT	6,139,297	08-18-98	2:46p	25b40n09.out
30B40N02	OUT	6,143,629	08-18-98	2:48p	30b40n02.out
30B40N03	OUT	6,150,134	08-18-98	2:48p	30b40n03.out
30B40N04	OUT	6,153,507	08-18-98	2:48p	30b40n04.out
30B40N05	OUT	6,152,213	08-18-98	2:48p	30b40n05.out
30B40N06	OUT	6,153,950	08-18-98	2:48p	30b40n06.out
30B40N07	OUT	6,153,784	08-18-98	2:49p	30b40n07.out
30B40N08	OUT	6,153,256	08-18-98	2:49p	30b40n08.out
30B40N09	OUT	6,142,074	08-18-98	2:49p	30b40n09.out
35B40N02	OUT	6,148,944	08-18-98	3:01p	35b40n02.out
35B40N03	OUT	6,156,140	08-18-98	3:01p	35b40n03.out
35B40N04	OUT	6,159,723	08-18-98	3:01p	35b40n04.out
35B40N05	OUT	6,157,481	08-18-98	3:01p	35b40n05.out
35B40N06	OUT	6,160,806	08-18-98	2:52p	35b40n06.out
35B40N07	OUT	6,160,381	08-18-98	2:52p	35b40n07.out
35B40N08	OUT	6,159,917	08-18-98	2:52p	35b40n08.out
35B40N09	OUT	6,146,935	08-18-98	2:52p	35b40n09.out
40B40N02	OUT	6,152,986	08-18-98	2:53p	40b40n02.out
40B40N03	OUT	6,158,818	08-18-98	2:54p	40b40n03.out
40B40N04	OUT	6,163,424	08-18-98	2:54p	40b40n04.out
40B40N05	OUT	6,160,326	08-18-98	2:54p	40b40n05.out
40B40N06	OUT	6,161,272	08-18-98	2:54p	40b40n06.out
40B40N07	OUT	6,161,456	08-18-98	2:54p	40b40n07.out
40B40N08	OUT	6,161,248	08-18-98	2:55p	40b40n08.out
40B40N09	OUT	6,148,635	08-18-98	2:55p	40b40n09.out
25B45N01	OUT	5,961,064	08-18-98	2:56p	25b45n01.out
25B45N02	OUT	6,127,011	08-18-98	2:56p	25b45n02.out
25B45N03	OUT	6,131,170	08-18-98	2:56p	25b45n03.out
25B45N04	OUT	6,137,514	08-18-98	2:57p	25b45n04.out
25B45N05	OUT	6,135,558	08-18-98	2:57p	25b45n05.out
25B45N06	OUT	6,138,965	08-18-98	2:57p	25b45n06.out
25B45N07	OUT	6,138,966	08-18-98	2:57p	25b45n07.out
25B45N08	OUT	6,138,398	08-18-98	2:57p	25b45n08.out
25B45N09	OUT	6,125,411	08-18-98	2:58p	25b45n09.out
25B45N10	OUT	5,949,661	08-18-98	2:58p	25b45n10.out
30B45N01	OUT	5,967,917	08-18-98	2:59p	30b45n01.out
30B45N02	OUT	6,095,075	08-18-98	2:59p	30b45n02.out
30B45N03	OUT	6,136,329	08-18-98	2:59p	30b45n03.out
30B45N04	OUT	6,141,108	08-18-98	2:59p	30b45n04.out
30B45N05	OUT	6,139,090	08-18-98	3:00p	30b45n05.out
30B45N06	OUT	6,141,590	08-18-98	3:00p	30b45n06.out
35B45N01	OUT	5,972,568	08-18-98	3:03p	35b45n01.out
35B45N02	OUT	6,135,528	08-18-98	3:03p	35b45n02.out
35B45N03	OUT	6,142,377	08-18-98	3:04p	35b45n03.out
35B45N04	OUT	6,146,407	08-18-98	3:04p	35b45n04.out
35B45N05	OUT	6,143,433	08-18-98	3:04p	35b45n05.out
35B45N06	OUT	6,147,694	08-18-98	3:04p	35b45n06.out
35B45N07	OUT	6,147,499	08-18-98	3:05p	35b45n07.out
35B45N08	OUT	6,146,549	08-18-98	3:05p	35b45n08.out
35B45N09	OUT	6,134,363	08-18-98	3:05p	35b45n09.out
35B45N10	OUT	5,959,094	08-18-98	3:05p	35b45n10.out
40B45N01	OUT	5,974,695	08-18-98	3:17p	40b45n01.out
40B45N02	OUT	6,138,591	08-18-98	3:17p	40b45n02.out
40B45N03	OUT	6,144,016	08-18-98	3:17p	40b45n03.out

40B45N04	OUT	6,148,459	08-18-98	3:17p	40b45n04.out
40B45N05	OUT	6,146,363	08-18-98	3:17p	40b45n05.out
40B45N06	OUT	6,147,822	08-18-98	3:18p	40b45n06.out
40B45N07	OUT	6,147,820	08-18-98	3:18p	40b45n07.out
40B45N08	OUT	6,147,284	08-18-98	3:18p	40b45n08.out
40B45N09	OUT	6,134,173	08-18-98	3:18p	40b45n09.out
40B45N10	OUT	5,960,135	08-18-98	3:19p	40b45n10.out
45B45N01	OUT	5,975,288	08-18-98	3:19p	45b45n01.out
45B45N02	OUT	6,141,453	08-18-98	3:19p	45b45n02.out
45B45N03	OUT	6,148,292	08-18-98	3:19p	45b45n03.out
45B45N04	OUT	6,152,909	08-18-98	3:20p	45b45n04.out
45B45N05	OUT	6,151,760	08-18-98	3:20p	45b45n05.out
45B45N06	OUT	6,152,861	08-18-98	3:20p	45b45n06.out
45B45N07	OUT	6,152,816	08-18-98	3:20p	45b45n07.out
45B45N08	OUT	6,151,880	08-18-98	3:20p	45b45n08.out
45B45N09	OUT	6,137,792	08-18-98	3:21p	45b45n09.out
45B45N10	OUT	5,961,047	08-18-98	3:21p	45b45n10.out
30B45N10	OUT	5,953,793	07-18-98	7:40p	30B45N10.OUT
30B45N08	OUT	6,139,888	07-25-98	11:51p	30B45N08.OUT
30B45N09	OUT	6,129,532	07-26-98	12:53a	30B45N09.OUT
30B45N07	OUT	6,141,674	07-28-98	8:54a	30B45N07.OUT
45B45N10	SUM	64,225	08-18-98	1:26p	45b45n10.sum
30B45N07	SUM	65,392	08-19-98	11:28a	30b45n07.sum
30B45N08	SUM	65,474	08-19-98	11:28a	30b45n08.sum
30B45N09	SUM	65,474	08-19-98	11:28a	30b45n09.sum
30B45N10	SUM	64,225	08-19-98	11:28a	30b45n10.sum
45B45N01	SUM	64,225	08-18-98	1:25p	45b45n01.sum
45B45N02	SUM	65,392	08-18-98	1:25p	45b45n02.sum
45B45N03	SUM	65,392	08-18-98	1:25p	45b45n03.sum
45B45N04	SUM	65,392	08-18-98	1:25p	45b45n04.sum
45B45N05	SUM	65,392	08-18-98	1:25p	45b45n05.sum
45B45N06	SUM	65,474	08-18-98	1:26p	45b45n06.sum
45B45N07	SUM	65,474	08-18-98	1:26p	45b45n07.sum
45B45N08	SUM	65,474	08-18-98	1:26p	45b45n08.sum
45B45N09	SUM	65,474	08-18-98	1:26p	45b45n09.sum
40B45N10	SUM	64,225	08-18-98	1:25p	40b45n10.sum
20B35N02	SUM	65,934	08-18-98	1:24p	20b35n02.sum
20B35N03	SUM	65,934	08-18-98	1:24p	20b35n03.sum
20B35N04	SUM	65,934	08-18-98	1:24p	20b35n04.sum
20B35N05	SUM	65,934	08-18-98	1:24p	20b35n05.sum
20B35N06	SUM	65,934	08-18-98	1:24p	20b35n06.sum
20B35N07	SUM	65,934	08-18-98	1:24p	20b35n07.sum
20B35N08	SUM	65,934	08-18-98	1:24p	20b35n08.sum
20B35N09	SUM	65,934	08-18-98	1:24p	20b35n09.sum
20B35N10	SUM	63,956	08-18-98	1:26p	20b35n10.sum
20B40N01	SUM	63,956	08-18-98	1:26p	20b40n01.sum
20B40N02	SUM	65,934	08-18-98	1:24p	20b40n02.sum
20B40N03	SUM	65,934	08-18-98	1:24p	20b40n03.sum
20B40N04	SUM	65,934	08-18-98	1:24p	20b40n04.sum
20B40N05	SUM	65,934	08-18-98	1:24p	20b40n05.sum
20B40N06	SUM	65,934	08-18-98	1:24p	20b40n06.sum
20B40N07	SUM	65,934	08-18-98	1:24p	20b40n07.sum
20B40N08	SUM	65,934	08-18-98	1:24p	20b40n08.sum
20B40N09	SUM	66,016	08-18-98	1:24p	20b40n09.sum
20B40N10	SUM	63,956	08-18-98	1:26p	20b40n10.sum

25B35N01	SUM	64,225	08-18-98	1:26p	25b35n01.sum
25B35N02	SUM	66,732	08-18-98	1:24p	25b35n02.sum
25B35N03	SUM	67,213	08-18-98	1:24p	25b35n03.sum
25B35N04	SUM	67,213	08-18-98	1:24p	25b35n04.sum
25B35N05	SUM	67,213	08-18-98	1:24p	25b35n05.sum
25B35N06	SUM	67,213	08-18-98	1:24p	25b35n06.sum
25B35N07	SUM	67,213	08-18-98	1:24p	25b35n07.sum
25B35N08	SUM	67,213	08-18-98	1:24p	25b35n08.sum
25B35N09	SUM	67,213	08-18-98	1:24p	25b35n09.sum
25B35N10	SUM	64,225	08-18-98	1:26p	25b35n10.sum
25B40N01	SUM	64,225	08-18-98	1:26p	25b40n01.sum
25B40N02	SUM	66,732	08-18-98	1:25p	25b40n02.sum
25B40N03	SUM	66,732	08-18-98	1:25p	25b40n03.sum
25B40N04	SUM	67,213	08-18-98	1:25p	25b40n04.sum
25B40N05	SUM	67,213	08-18-98	1:25p	25b40n05.sum
25B40N06	SUM	67,213	08-18-98	1:25p	25b40n06.sum
25B40N07	SUM	67,213	08-18-98	1:25p	25b40n07.sum
25B40N08	SUM	67,213	08-18-98	1:25p	25b40n08.sum
25B40N09	SUM	67,295	08-18-98	1:25p	25b40n09.sum
25B40N10	SUM	64,225	08-18-98	1:26p	25b40n10.sum
25B45N01	SUM	64,225	08-18-98	1:25p	25b45n01.sum
25B45N02	SUM	65,041	08-18-98	1:25p	25b45n02.sum
25B45N03	SUM	65,041	08-18-98	1:25p	25b45n03.sum
25B45N04	SUM	65,392	08-18-98	1:25p	25b45n04.sum
25B45N05	SUM	65,392	08-18-98	1:25p	25b45n05.sum
25B45N06	SUM	65,392	08-18-98	1:25p	25b45n06.sum
25B45N07	SUM	65,392	08-18-98	1:25p	25b45n07.sum
25B45N08	SUM	65,392	08-18-98	1:25p	25b45n08.sum
25B45N09	SUM	65,474	08-18-98	1:25p	25b45n09.sum
25B45N10	SUM	64,225	08-18-98	1:25p	25b45n10.sum
30B35N01	SUM	64,225	08-18-98	1:26p	30b35n01.sum
30B35N02	SUM	66,732	08-18-98	1:25p	30b35n02.sum
30B35N03	SUM	67,213	08-18-98	1:25p	30b35n03.sum
30B35N04	SUM	67,213	08-18-98	1:25p	30b35n04.sum
30B35N05	SUM	67,213	08-18-98	1:25p	30b35n05.sum
30B35N06	SUM	67,213	08-18-98	1:25p	30b35n06.sum
30B35N07	SUM	67,213	08-18-98	1:25p	30b35n07.sum
30B35N08	SUM	67,213	08-18-98	1:25p	30b35n08.sum
30B35N09	SUM	67,213	08-18-98	1:25p	30b35n09.sum
30B35N10	SUM	64,225	08-18-98	1:26p	30b35n10.sum
30B40N01	SUM	64,225	08-18-98	1:26p	30b40n01.sum
30B40N02	SUM	66,732	08-18-98	1:25p	30b40n02.sum
30B40N03	SUM	66,814	08-18-98	1:25p	30b40n03.sum
30B40N04	SUM	67,213	08-18-98	1:25p	30b40n04.sum
30B40N05	SUM	67,213	08-18-98	1:25p	30b40n05.sum
30B40N06	SUM	67,213	08-18-98	1:25p	30b40n06.sum
30B40N07	SUM	67,213	08-18-98	1:25p	30b40n07.sum
30B40N08	SUM	67,213	08-18-98	1:25p	30b40n08.sum
30B40N09	SUM	67,295	08-18-98	1:25p	30b40n09.sum
30B40N10	SUM	64,225	08-18-98	1:26p	30b40n10.sum
30B45N01	SUM	64,225	08-18-98	1:25p	30b45n01.sum
30B45N02	SUM	65,041	08-18-98	1:25p	30b45n02.sum
30B45N03	SUM	65,041	08-18-98	1:25p	30b45n03.sum
30B45N04	SUM	65,392	08-18-98	1:25p	30b45n04.sum
30B45N05	SUM	65,392	08-18-98	1:25p	30b45n05.sum

30B45N06	SUM	65,392	08-18-98	1:25p	30b45n06.sum
35B40N01	SUM	64,225	08-18-98	1:26p	35b40n01.sum
35B40N02	SUM	66,732	08-18-98	1:25p	35b40n02.sum
35B40N03	SUM	67,213	08-18-98	1:25p	35b40n03.sum
35B40N04	SUM	67,213	08-18-98	1:25p	35b40n04.sum
35B40N05	SUM	67,213	08-18-98	1:25p	35b40n05.sum
35B40N06	SUM	67,213	08-18-98	1:25p	35b40n06.sum
35B40N07	SUM	67,213	08-18-98	1:25p	35b40n07.sum
35B40N08	SUM	67,213	08-18-98	1:25p	35b40n08.sum
35B40N09	SUM	67,295	08-18-98	1:25p	35b40n09.sum
35B40N10	SUM	64,225	08-18-98	1:27p	35b40n10.sum
35B45N01	SUM	64,225	08-18-98	1:25p	35b45n01.sum
35B45N02	SUM	65,041	08-18-98	1:25p	35b45n02.sum
35B45N03	SUM	65,392	08-18-98	1:25p	35b45n03.sum
35B45N04	SUM	65,392	08-18-98	1:25p	35b45n04.sum
35B45N05	SUM	65,392	08-18-98	1:25p	35b45n05.sum
35B45N06	SUM	65,392	08-18-98	1:25p	35b45n06.sum
35B45N07	SUM	65,474	08-18-98	1:25p	35b45n07.sum
35B45N08	SUM	65,474	08-18-98	1:25p	35b45n08.sum
35B45N09	SUM	65,474	08-18-98	1:25p	35b45n09.sum
35B45N10	SUM	64,225	08-18-98	1:25p	35b45n10.sum
40B40N01	SUM	64,225	08-18-98	1:27p	40b40n01.sum
40B40N02	SUM	66,732	08-18-98	1:25p	40b40n02.sum
40B40N03	SUM	67,213	08-18-98	1:25p	40b40n03.sum
40B40N04	SUM	67,213	08-18-98	1:25p	40b40n04.sum
40B40N05	SUM	67,213	08-18-98	1:25p	40b40n05.sum
40B40N06	SUM	67,213	08-18-98	1:25p	40b40n06.sum
40B40N07	SUM	67,213	08-18-98	1:25p	40b40n07.sum
40B40N08	SUM	67,213	08-18-98	1:25p	40b40n08.sum
40B40N09	SUM	67,295	08-18-98	1:25p	40b40n09.sum
40B40N10	SUM	64,225	08-18-98	1:27p	40b40n10.sum
40B45N01	SUM	64,225	08-18-98	1:25p	40b45n01.sum
40B45N02	SUM	65,041	08-18-98	1:25p	40b45n02.sum
40B45N03	SUM	65,392	08-18-98	1:25p	40b45n03.sum
40B45N04	SUM	65,392	08-18-98	1:25p	40b45n04.sum
40B45N05	SUM	65,392	08-18-98	1:25p	40b45n05.sum
40B45N06	SUM	65,474	08-18-98	1:25p	40b45n06.sum
40B45N07	SUM	65,474	08-18-98	1:25p	40b45n07.sum
40B45N08	SUM	65,474	08-18-98	1:25p	40b45n08.sum
40B45N09	SUM	65,474	08-18-98	1:25p	40b45n09.sum
20B35N01	SUM	63,956	08-18-98	1:26p	20b35n01.sum
20B35NC		54,617	08-18-98	1:44p	20b35nc
20B35NC	O	727,844	08-18-98	1:44p	20b35nc.O
20B35ND		54,623	08-18-98	1:44p	20b35nd
20B35ND	O	727,947	08-18-98	1:44p	20b35nd.O
20B35NE		54,304	08-18-98	1:44p	20b35ne
20B35NE	O	725,006	08-18-98	1:44p	20b35ne.O
20B35NF		54,293	08-18-98	1:44p	20b35nf
20B35NF	O	725,006	08-18-98	1:44p	20b35nf.O
20B35NG		54,302	08-18-98	1:44p	20b35ng
20B35NG	O	725,006	08-18-98	1:44p	20b35ng.O
25B35NC		54,596	08-18-98	1:47p	25b35nc
25B35NC	O	727,947	08-18-98	1:47p	25b35nc.O
25B35NE		54,284	08-18-98	1:47p	25b35ne
25B35NE	O	725,231	08-18-98	1:47p	25b35ne.O

25B35NF		54,281	08-18-98	1:47p	25b35nf
25B35NF	O	725,241	08-18-98	1:47p	25b35nf.O
25B35NG		54,275	08-18-98	1:47p	25b35ng
25B35NG	O	725,363	08-18-98	1:47p	25b35ng.O
30B35C		54,624	08-18-98	1:48p	30b35c
30B35D		54,616	08-18-98	1:48p	30b35d
30B35E		54,295	08-18-98	1:48p	30b35e
30B35F		54,298	08-18-98	1:48p	30b35f
30B35G		54,309	08-18-98	1:48p	30b35g
30B35NC	O	728,047	08-18-98	1:48p	30b35nc.O
30B35ND	O	727,847	08-18-98	1:48p	30b35nd.O
30B35NE	O	725,006	08-18-98	1:48p	30b35ne.O
30B35NF	O	724,893	08-18-98	1:48p	30b35nf.O
30B35NG	O	725,006	08-18-98	1:48p	30b35ng.O
35B40NC		54,614	08-18-98	1:54p	35b40nc
30B40NC		54,623	08-18-98	1:52p	30b40nc
30B40NC	O	727,947	08-18-98	1:52p	30b40nc.O
30B40ND		54,616	08-18-98	1:52p	30b40nd
30B40ND	O	727,947	08-18-98	1:52p	30b40nd.O
30B40NE		54,302	08-18-98	1:52p	30b40ne
30B40NE	O	725,109	08-18-98	1:52p	30b40ne.O
30B40NF		54,302	08-18-98	1:52p	30b40nf
30B40NF	O	725,109	08-18-98	1:52p	30b40nf.O
30B40NG		54,310	08-18-98	1:52p	30b40ng
30B40NG	O	725,109	08-18-98	1:52p	30b40ng.O
25B40NC	O	727,844	08-18-98	1:50p	25b40nc.O
25B40ND		54,612	08-18-98	1:50p	25b40nd
25B40ND	O	730,731	08-18-98	1:50p	25b40nd.O
25B40NE		54,300	08-18-98	1:50p	25b40ne
25B40NE	O	725,006	08-18-98	1:50p	25b40ne.O
25B40NF		54,291	08-18-98	1:50p	25b40nf
25B40NF	O	725,109	08-18-98	1:50p	25b40nf.O
25B40NG		54,294	08-18-98	1:50p	25b40ng
25B40NG	O	725,241	08-18-98	1:50p	25b40ng.O
25B40NC		54,619	08-18-98	1:50p	25b40nc
20B40NC	O	727,947	08-18-98	1:50p	20b40nc.O
20B40ND		54,614	08-18-98	1:50p	20b40nd
20B40ND	O	727,947	08-18-98	1:50p	20b40nd.O
20B40NE		54,294	08-18-98	1:50p	20b40ne
20B40NE	O	725,031	08-18-98	1:50p	20b40ne.O
20B40NF		54,293	08-18-98	1:50p	20b40nf
20B40NF	O	725,006	08-18-98	1:50p	20b40nf.O
20B40NG		54,277	08-18-98	1:50p	20b40ng
20B40NG	O	725,006	08-18-98	1:50p	20b40ng.O
20B40NC		54,608	08-18-98	1:50p	20b40nc
35B40NC	O	727,967	08-18-98	1:54p	35b40nc.O
35B40ND		54,612	08-18-98	1:54p	35b40nd
35B40ND	O	727,957	08-18-98	1:54p	35b40nd.O
35B40NE		54,297	08-18-98	1:54p	35b40ne
35B40NE	O	725,013	08-18-98	1:54p	35b40ne.O
35B40NF		54,305	08-18-98	1:54p	35b40nf
35B40NF	O	725,122	08-18-98	1:54p	35b40nf.O
35B40NG		54,303	08-18-98	1:54p	35b40ng
35B40NG	O	725,128	08-18-98	1:54p	35b40ng.O
40B40NC		54,607	08-18-98	1:54p	40b40nc

40B40NC	O	727,931	08-18-98	1:54p	40b40nc.O
40B40ND		54,605	08-18-98	1:54p	40b40nd
40B40ND	O	727,976	08-18-98	1:54p	40b40nd.O
40B40NE		54,297	08-18-98	1:54p	40b40ne
40B40NE	O	725,138	08-18-98	1:54p	40b40ne.O
40B40NF		54,287	08-18-98	1:54p	40b40nf
40B40NF	O	725,122	08-18-98	1:54p	40b40nf.O
40B40NG		54,288	08-18-98	1:54p	40b40ng
40B40NG	O	725,209	08-18-98	1:54p	40b40ng.O
25B45NE		54,296	08-18-98	1:56p	25b45ne
25B45NE	O	724,911	08-18-98	1:56p	25b45ne.O
25B45NF		54,282	08-18-98	1:56p	25b45nf
25B45NF	O	724,911	08-18-98	1:56p	25b45nf.O
25B45NG		54,291	08-18-98	1:56p	25b45ng
25B45NG	O	725,014	08-18-98	1:56p	25b45ng.O
30B45NB		54,935	08-18-98	1:57p	30b45nb
30B45NB	O	730,827	08-18-98	1:57p	30b45nb.O
30B45NC		54,623	08-18-98	1:57p	30b45nc
30B45NC	O	727,844	08-18-98	1:57p	30b45nc.O
30B45ND		54,623	08-18-98	1:57p	30b45nd
30B45ND	O	727,976	08-18-98	1:57p	30b45nd.O
30B45NE		54,287	08-18-98	1:57p	30b45ne
30B45NE	O	724,909	08-18-98	1:57p	30b45ne.O
30B45NF		54,298	08-18-98	1:57p	30b45nf
30B45NF	O	725,006	08-18-98	1:57p	30b45nf.O
30B45NG		54,301	08-18-98	1:57p	30b45ng
30B45NG	O	725,006	08-18-98	1:57p	30b45ng.O
35B45NA		54,918	08-18-98	1:58p	35b45na
35B45NA	O	731,016	08-18-98	1:58p	35b45na.O
35B45NB		54,914	08-18-98	1:58p	35b45nb
35B45NB	O	731,000	08-18-98	1:58p	35b45nb.O
35B45NC		54,612	08-18-98	1:59p	35b45nc
35B45NC	O	727,852	08-18-98	1:59p	35b45nc.O
35B45ND		54,605	08-18-98	1:59p	35b45nd
35B45ND	O	728,090	08-18-98	1:59p	35b45nd.O
35B45NE		54,286	08-18-98	1:59p	35b45ne
35B45NE	O	725,146	08-18-98	1:59p	35b45ne.O
35B45NF		54,289	08-18-98	1:59p	35b45nf
35B45NF	O	725,011	08-18-98	1:59p	35b45nf.O
35B45NG		54,287	08-18-98	1:59p	35b45ng
35B45NG	O	725,014	08-18-98	1:59p	35b45ng.O
35B45NH		54,281	08-18-98	1:59p	35b45nh
35B45NH	O	725,014	08-18-98	1:59p	35b45nh.O
35B45NI		54,299	08-18-98	1:59p	35b45ni
35B45NI	O	725,146	08-18-98	1:59p	35b45ni.O
35B45NJ		54,307	08-18-98	1:59p	35b45nj
35B45NJ	O	725,021	08-18-98	1:59p	35b45nj.O
35B45NX		54,922	08-18-98	1:59p	35b45nx
35B45NX	O	730,884	08-18-98	1:59p	35b45nx.O
35B45NY		54,919	08-18-98	1:59p	35b45ny
35B45NY	O	730,884	08-18-98	1:59p	35b45ny.O
35B45NZ		54,919	08-18-98	1:59p	35b45nz
35B45NZ	O	730,884	08-18-98	1:59p	35b45nz.O
40B45NE	O	735,818	08-18-98	2:00p	40b45ne.O
40B45NF	O	725,149	08-18-98	2:00p	40b45nf.O

40B45NG	O	725,043	08-18-98	2:00p	40b45ng.O
40B45NE		54,272	08-18-98	2:05p	40b45ne
40B45NF		54,280	08-18-98	2:05p	40b45nf
40B45NG		54,279	08-18-98	2:05p	40b45ng
45B45NE		54,288	08-18-98	2:06p	45b45ne
45B45NE	O	724,911	08-18-98	2:06p	45b45ne.O
45B45NF		54,295	08-18-98	2:06p	45b45nf
45B45NF	O	724,911	08-18-98	2:06p	45b45nf.O
45B45NG		54,298	08-18-98	2:06p	45b45ng
45B45NG	O	724,930	08-18-98	2:06p	45b45ng.O
CASE2F		54,309	08-19-98	4:48p	CASE2F
CASE2F	O	730,283	08-19-98	4:48p	CASE2F.O
CASE3F		54,317	08-19-98	4:48p	CASE3F
CASE3F	O	730,241	08-19-98	4:48p	CASE3F.O
CASE4F		54,315	08-19-98	4:48p	CASE4F
CASE4F	O	731,313	08-19-98	4:48p	CASE4F.O
CASE5F		54,354	08-19-98	4:48p	CASE5F
CASE5F	O	733,161	08-19-98	4:48p	CASE5F.O
44BWR54U	TMP	45,434	08-13-98	2:31p	44BWR54u.tmp
AMIGO10B	BAS	15,987	08-13-98	2:37p	Amigo10b.bas
BWR	PRN	821,716	08-16-98	2:42p	BWR.PRN
BWRcrit	doc	806,912	08-21-98	5:38p	BWRcrit.doc
Bwrcrit	mcd	16,872	08-21-98	3:26p	Bwrcrit.mcd
BWRcrit	xls	116,736	08-24-98	8:48a	BWRcrit.xls

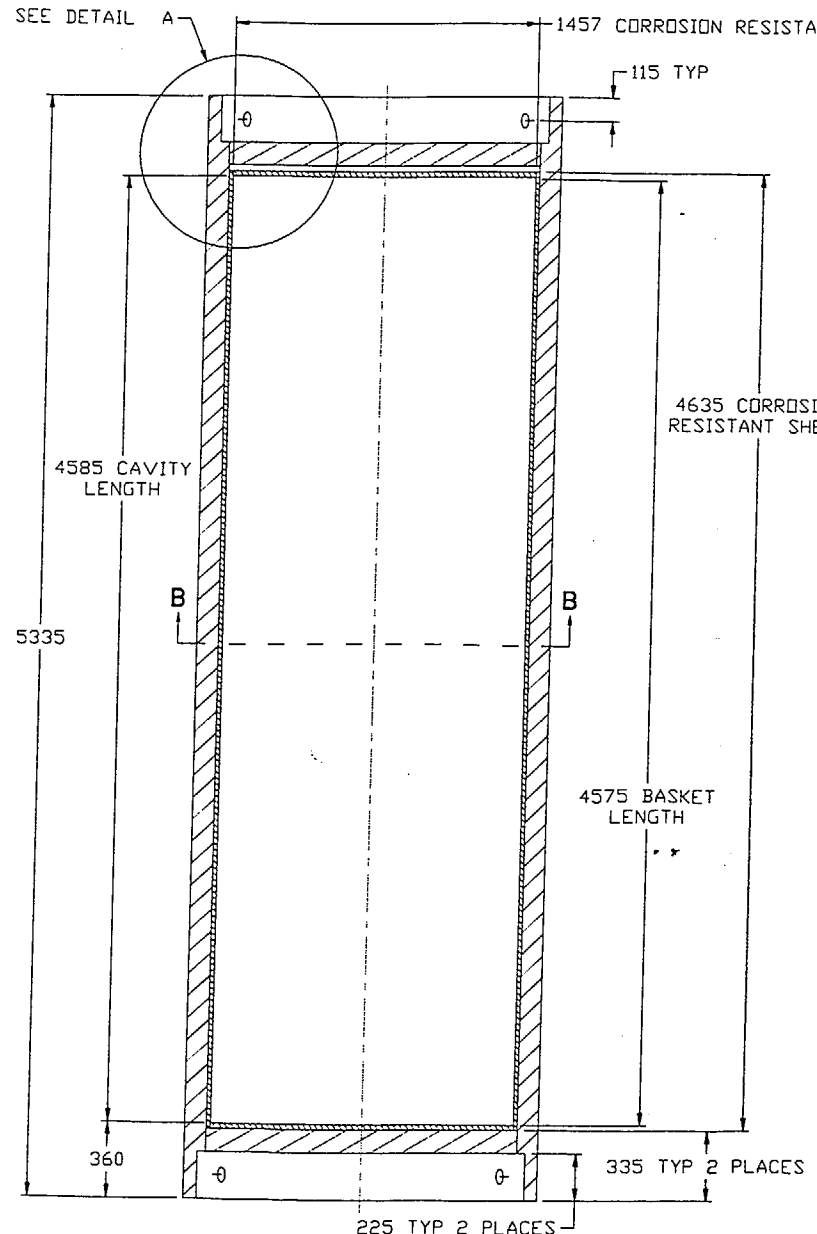
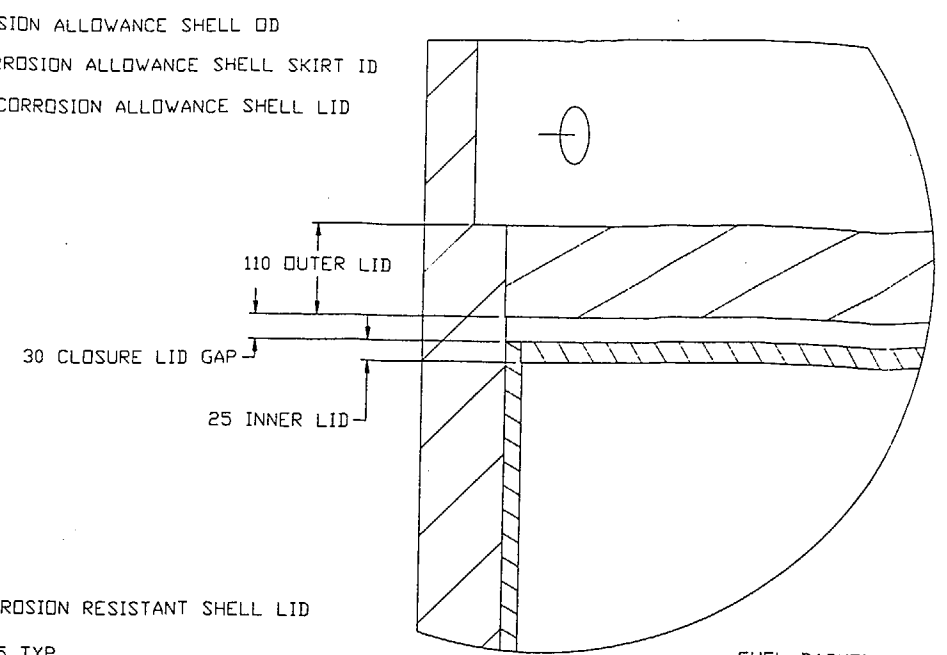
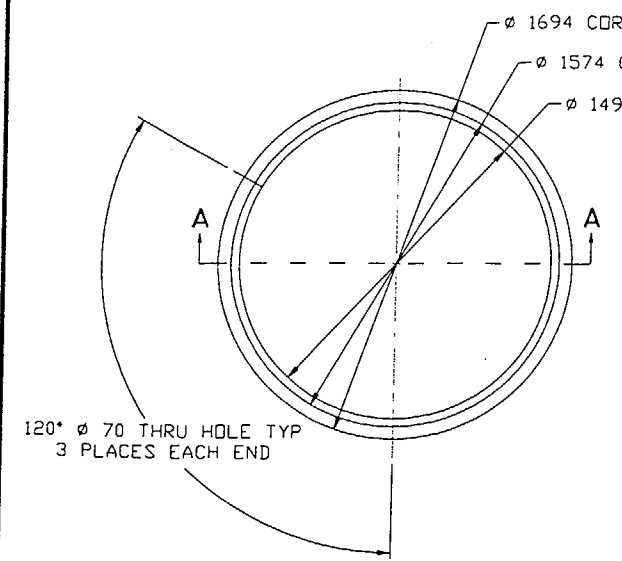

**DETAIL A**  
BASKET COMPONENTS NOT SHOWN IN THIS VIEW

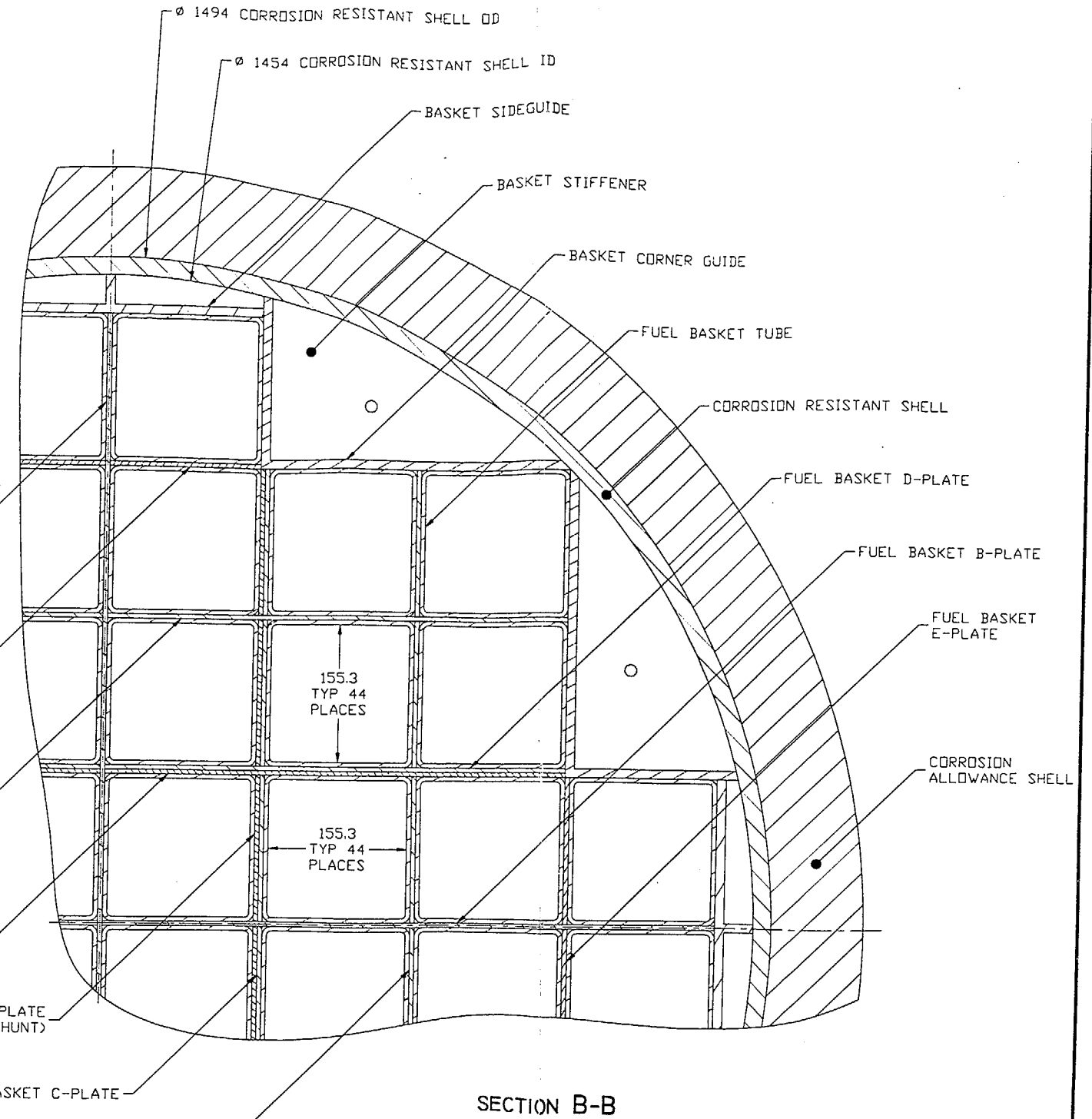

COMPONENT NAME	MATERIAL	THICKNESS	QTY REQ
BASKET SIDEGUIDE	SA-516 K02700	10	16
BASKET STIFFENER	SA-516 K02700	10	64
BASKET CORNER GUIDE	SA-516 K02700	10	32
CORROSION ALLOWANCE SHELL	SA-516 K02700	100	1
CORROSION RESISTANT SHELL LID	SA-516 K02700	110	2
CORROSION RESISTANT SHELL	SB-575 N06022	20	1
CORROSION RESISTANT SHELL LID	SB-575 N06022	25	2
FUEL BASKET A-PLATE	SA-516 K02700	5	4
FUEL BASKET B-PLATE	SA-516 K02700	5	4
FUEL BASKET C-PLATE	SA-516 K02700	5	16
FUEL BASKET D-PLATE	SA-516 K02700	5	16
FUEL BASKET E-PLATE	SA-516 K02700	5	16
FUEL BASKET F-PLATE	SB-209 A96061 T4	5	8
FUEL BASKET G-PLATE	SB-209 A96061 T4	5	8
FUEL BASKET TUBE	SA-516 K02700	5	44

**SECTION A-A**  
BASKET COMPONENTS NOT SHOWN IN THIS VIEW

DO NOT SCALE FROM SKETCH  
UNITS: mm

"FOR INFORMATION ONLY"  
44 BWR ABSORBER PLATES  
UCF WASTE PACKAGE ASSEMBLY

SKETCH NUMBER: SK-0108. REV 00  
 SKETCHED BY: MARTIN LEWIS *MLL* *SMB* *TWD*  
 DATE: 08/21/98 *08/24/98* *08/24/98* *8.24.98*  
 FILE: o:/Wpd/Cad/Sketches/SK-0108 REV 00



```

COMMON grams()
COMMON numden()
COMMON total()
COMMON time()
50 CLS
CLEAR
'
' This program gets nuclide concentrations in grams
' from summarized origin-s output for 30 principal isotopes
' and creates desired MCNP input files using a user created
' MCNP template file. The template file must have a FUELTOT##
' in the cell card where the total number density for the fuel
' region node ## is to be located, and a FUELNUM## in the node 33 material
' card where the number densities for the 30 isotopes are to be placed.
'
' setup and dimension variables
DIM iso$(30) '29 principl isotopes + oxygen
DIM grams(30, 50, 10) 'gram concentraions of 30 isotopes at 100 different decay times
DIM numden(30, 50, 10) 'number densities of 30 isotopes at 100 different decay times
DIM total(50, 10) 'total number density of 30 isotopes at 100 different deay times
DIM MW(30) 'atomic weights of the 30 isotopes
DIM time(50, 10) '100 decay times
DIM MCNPIDS(30) 'MCNP IDs for 30 principal isotopes
DIM nodeht(10) 'height of each node in active fuel region (total=360.172)
DIM nodevol(10) 'volume of each node in active fuel region (total=51967.766)
'
' 30 principal isotopes, their atomic weights, and MCNP IDs
'
iso$(1) = " O 16 ": MW(1) = 15.994915#: MCNPIDS(1) = "8016.50C"
iso$(2) = " MO 95 ": MW(2) = 94.905839#: MCNPIDS(2) = "42095.50C"
iso$(3) = " RU101 ": MW(3) = 100.905576#: MCNPIDS(3) = "44101.50C"
iso$(4) = " TC 99 ": MW(4) = 98.9062749#: MCNPIDS(4) = "43099.50C"
iso$(5) = " RH103 ": MW(5) = 102.905511#: MCNPIDS(5) = "45103.50C"
iso$(6) = " AG109 ": MW(6) = 108.904756#: MCNPIDS(6) = "47109.50C"
iso$(7) = " ND143 ": MW(7) = 142.909779#: MCNPIDS(7) = "60143.50C"
iso$(8) = " ND145 ": MW(8) = 144.912538#: MCNPIDS(8) = "60145.50C"
iso$(9) = " SM147 ": MW(9) = 146.914867#: MCNPIDS(9) = "62147.50C"
iso$(10) = " SM149 ": MW(10) = 148.91718#: MCNPIDS(10) = "62149.50C"
iso$(11) = " SM150 ": MW(11) = 149.917276#: MCNPIDS(11) = "62150.50C"
iso$(12) = " SM151 ": MW(12) = 150.919919#: MCNPIDS(12) = "62151.50C"
iso$(13) = " SM152 ": MW(13) = 151.919756#: MCNPIDS(13) = "62152.50C"
iso$(14) = " EU151 ": MW(14) = 150.919838#: MCNPIDS(14) = "63151.55C"
iso$(15) = " EU153 ": MW(15) = 152.921242#: MCNPIDS(15) = "63153.55C"
iso$(16) = " GD155 ": MW(16) = 154.922662#: MCNPIDS(16) = "64155.50C"
iso$(17) = " U233 ": MW(17) = 233.039522#: MCNPIDS(17) = "92233.50C"
iso$(18) = " U234 ": MW(18) = 234.040904#: MCNPIDS(18) = "92234.50C"
iso$(19) = " U235 ": MW(19) = 235.043915#: MCNPIDS(19) = "92235.50C"
iso$(20) = " U236 ": MW(20) = 236.045637#: MCNPIDS(20) = "92236.50C"
iso$(21) = " U238 ": MW(21) = 238.05077#: MCNPIDS(21) = "92238.50C"
iso$(22) = " NP237 ": MW(22) = 237.048056#: MCNPIDS(22) = "93237.55C"
iso$(23) = " PU238 ": MW(23) = 238.049511#: MCNPIDS(23) = "94238.50C"
iso$(24) = " PU239 ": MW(24) = 239.052146#: MCNPIDS(24) = "94239.55C"
iso$(25) = " PU240 ": MW(25) = 240.053882#: MCNPIDS(25) = "94240.50C"
iso$(26) = " PU241 ": MW(26) = 241.056737#: MCNPIDS(26) = "94241.50C"
iso$(27) = " PU242 ": MW(27) = 242.058725#: MCNPIDS(27) = "94242.50C"
iso$(28) = " AM241 ": MW(28) = 241.056714#: MCNPIDS(28) = "95241.50C"
iso$(29) = " AM242M": MW(29) = 242.059502#: MCNPIDS(29) = "95242.50C"
iso$(30) = " AM243 ": MW(30) = 243.061367#: MCNPIDS(30) = "95243.50C"
'
' set height in cm and volume in cm^3 of each node in active fuel region
'
pelletOD = 1.0414
PRINT "Enter fuel pellet OD ["; pelletOD; "];"
INPUT OD
IF OD > 0 THEN pelletOD = OD
nodeht(1) = 15.24

```

```

nodevol(1) = 60 * 3.141593 * pelletOD ^ 2 / 4 * nodeht(1)
nodeht(10) = nodeht(1): nodevol(10) = nodevol(1)
nodeht(2) = 30.48
nodevol(2) = 60 * 3.141593 * pelletOD ^ 2 / 4 * nodeht(2)
nodeht(3) = nodeht(2): nodevol(3) = nodevol(2)
nodeht(5) = nodeht(2): nodevol(5) = nodevol(2)
nodeht(4) = 45.72
nodevol(4) = 60 * 3.141593 * pelletOD ^ 2 / 4 * nodeht(4)
nodeht(6) = nodeht(4): nodevol(6) = nodevol(4)
nodeht(7) = nodeht(4): nodevol(7) = nodevol(4)
nodeht(8) = nodeht(4): nodevol(8) = nodevol(4)
nodeht(9) = 64.11
nodevol(9) = 60 * 3.141593 * pelletOD ^ 2 / 4 * nodeht(9)
'
' other variables used
'
n = 30 'total number of principal isotopes
Umass = 171177.7 'mass of U in grams per GE8x8 fuel assembly
fuelht = 368.91 'active length of fuel
Na = .602252 'Avagadro's number
nodes = 10 'total number of nodes per assembly
'
' Enter name of input and output files
'
INPUT "Enter ORIGEN-S output summary file prefix"; file$
'
' get gram concentrations and calculate number densities for each node
'
FOR k = 1 TO nodes
  tcount = 1 'counter for number of times read
  IF k > 9 THEN
    filename$ = file$ + LTRIM$(RTRIM$(STR$(k))) + ".sum"
  ELSE
    filename$ = file$ + "0" + LTRIM$(RTRIM$(STR$(k))) + ".sum"
  END IF
  OPEN filename$ FOR INPUT ACCESS READ AS #1
  '
  'locate start of isotope list
  '
  'Find start of a ORIGEN-S grams table in summary output and get first set of times
  '
  start$ = ""
  Line$ = ""
  DO UNTIL LEFT$(start$, 19) = " CHARGE"
    LINE INPUT #1, start$
  LOOP
  columns = (LEN(start$) / 10) 'determine number of columns in table
  FOR i = 3 TO (columns - 1) 'get times starting at fourth column
    time(tcount, k) = VAL(MID$(start$, i * 10 + 1, 7))
    IF MID$(start$, i * 10 + 9, 1) = "D" THEN
      time(tcount, k) = time(tcount, k) / 365.25 'convert days to years
    END IF
    tcount = tcount + 1
  NEXT i
  '
  'Get isotope grams from first table
  '
  DO UNTIL LEFT$(Line$, 20) = " INITIAL"
    LINE INPUT #1, Line$
    FOR i = 1 TO n ' Check to see if line has isotope that is on the list
      IF iso$(i) = LEFT$(Line$, 10) THEN
        FOR j = 3 TO (columns - 1) 'get grams starting at fourth
          grams(i, j - 2, k) = VAL(MID$(Line$, j * 10 + 1, 10))
        NEXT j
      END IF
    NEXT i
  LOOP
'

```

```

' Load in times and gram concentrations from remaining tables in output
DO UNTIL EOF(1)
  columns = (LEN(Line$) / 10)      'determine number of columns in table
  itcount = tcount
  Newtable$ = LEFT$(Line$, 31)
  FOR i = 2 TO (columns - 1)      'get times starting at third column
    time(tcount, k) = VAL(MID$(Line$, i * 10 + 1, 7))
    IF MID$(Line$, i * 10 + 9, 1) = "D" THEN
      time(tcount, k) = time(tcount, k) / 365.25      'convert days to
years
      END IF
      tcount = tcount + 1
    NEXT i
  DO UNTIL (LEFT$(Line$, 20) = "      INITIAL" AND LEFT$(Line$, 31) <>
Newtable$) OR EOF(1)
    LINE INPUT #1, Line$
    FOR i = 1 TO n      ' Check to see if line has isotope that is on
the list
      IF iso$(i) = LEFT$(Line$, 10) THEN
        FOR j = 2 TO (columns - 1)      'get grams starting at
third column
          grams(i, itcount + j - 2, k) = VAL(MID$(Line$, j
* 10 + 1, 10))
        NEXT j
      END IF
    NEXT i
  LOOP
  PRINT "Finished loading PI concentrations for node "; k; " from file "; filename$
  CLOSE #1
  '
  'Calculate number densities (in atoms/b-cm) for each isotope at each time
  FOR i = 1 TO tcount - 1
    numden(1, i, k) = ((nodeht(k) / fuelht) * Umass * 32 / 238) / MW(1) / nodevol(k)
* Na
    total(i, k) = numden(1, i, k)
    FOR j = 2 TO n
      numden(j, i, k) = grams(j, i, k) / MW(j) / nodevol(k) * Na
      total(i, k) = total(i, k) + numden(j, i, k)      'add number density to
total
    NEXT j
  NEXT i
NEXT k
'
' Select times to make MCNP files for
PRINT "Number Densities are available for the following times (#'s 1 to "; (tcount - 1); "):"
PRINT
FOR i = 1 TO tcount - 1
  PRINT "      "; i; " - "; time(i, 1); "years",
NEXT i
100 PRINT "Enter time range for MCNP inputs using the format start#,end#"
INPUT "(enter same # twice for a single time)"; startnum, endnum
IF (startnum > (tcount - 1)) OR (endnum > (tcount - 1)) OR (startnum < 1) OR (endnum < 1) THEN
  PRINT "Starting or ending number outside of range! Select again."
  GOTO 100
END IF
'
' Build MCNP input files
150 INPUT "Enter MCNP input template file name"; tempfile$
INPUT "Enter prefix for MCNP input files to be created (6 char. max)"; outfile$
FOR i = startnum TO endnum
  OPEN tempfile$ FOR INPUT ACCESS READ AS #1
  '
  'Set file name decay time designator

```

```

SELECT CASE i
  CASE 23      x$ = "a"
  CASE 24      x$ = "b"
  CASE 25      x$ = "c"
  CASE 26      x$ = "d"
  CASE 30      x$ = "e"
  CASE 37      x$ = "f"
  CASE 38      x$ = "g"
  CASE 39      x$ = "h"
  CASE 45      x$ = "i"
  CASE 47      x$ = "j"
  CASE 15      x$ = "v"
  CASE 18      x$ = "w"
  CASE 19      x$ = "x"
  CASE 20      x$ = "y"
  CASE 21      x$ = "z"
  CASE ELSE
    x$ = LTRIM$(STR$(i))
END SELECT
z$ = outfile$ + x$
OPEN z$ FOR OUTPUT ACCESS WRITE AS #2
DO UNTIL EOF(1)
  flag = 0
  LINE INPUT #1, Line$
  IF VAL(LEFT$(Line$, 5)) <> 0 THEN
    outline$ = Line$
    linelen = LEN(Line$)
    FOR j = 1 TO (linelen - 7)
      chunk$ = MID$(Line$, j, 7)
      IF chunk$ = "FUELTOT" THEN
        nodenum = VAL(RIGHT$(MID$(Line$, j, 9), 2)) 'Determine
what node this is
        PRINT Line$
        leftline$ = LEFT$(Line$, j - 1)
        rightline$ = RIGHT$(Line$, (linelen - 9 - j))
        outline$ = leftline$ + STR$(total(i, nodenum)) +
rightline$
      END IF
    NEXT j
    PRINT #2, outline$
  ELSEIF LEFT$(Line$, 1) = "M" OR LEFT$(Line$, 1) = "m" THEN 'then this is a
material line
    outline$ = Line$
    linelen = LEN(Line$)
    FOR j = 1 TO (linelen)
      'scan the line to see if it is for a
fuel node
      chunk$ = MID$(Line$, j, 7)
      IF chunk$ = "FUELNUM" THEN
        nodenum = VAL(RIGHT$(MID$(Line$, j, 9), 2)) 'Determine
what node this is
        PRINT Line$
        leftline$ = LEFT$(Line$, j - 1)
        rightline$ = MID$(Line$, j + 9)

```

```

                outline$ = leftline$ + MCNPID$(1) + " " +
STR$(numden(1, i, nodenum)) + rightline$
                flag = 1
                PRINT #2, "C      "; file$ + RIGHT$(MID$(Line$, j, 9),
2); ".sum "; time(i, nodenum); " years decay"
                END IF
                NEXT j
                PRINT #2, outline$
                IF flag = 1 THEN
                FOR j = 2 TO n
                IF numden(j, i, nodenum) <> 0 THEN
                PRINT #2, "      "; MCNPID$(j); " "; numden(j,
i, nodenum)
                END IF
                NEXT j
                END IF
                ELSE
                PRINT #2, Line$
                END IF
                LOOP
                CLOSE #1
                CLOSE #2
                NEXT i
                PRINT "MCNP input files created. Process another template file(y/n)?"
                DO
                z$ = INKEY$
                LOOP UNTIL z$ <> ""
                IF z$ = "y" OR z$ = "Y" THEN
                CLS
                GOTO 150
                END IF
                PRINT "Process another ORIGEN-S file(y/n)?"
                DO
                z$ = INKEY$
                LOOP UNTIL z$ <> ""
                IF z$ = "y" OR z$ = "Y" THEN
                CLS
                GOTO 50
                END IF
                END

```

VolMass

	A	B	C	D	E	F
1	<b>Volumes and Masses of 44 BWR Absorber Plate WP Basket Materials In Intact and Degraded Configurations</b>					
2						
3						
4	<u>WP Empty Volume</u>					
5	44 BWR WP Inner diameter			1.452	m	
6	44 BWR WP Inner length			4.585	m	
7	Empty 44 BWR WP Int. Volume			7.592	m <sup>3</sup>	
8						
9	BWR Assembly Volume Inside Channel OD			0.070	m <sup>3</sup>	
10	44 BWR Assembly Volume			3.097	m <sup>3</sup>	
11	Void Space in full 44 BWR minus basket volume			4.495	m <sup>3</sup>	
12	Void Space in full 44 BWR WP w/ intact basket			3.222	m <sup>3</sup>	
13						
14						
15	<u>Densities</u>					
16	Carbon Steel (A516)				7832	kg/m <sup>3</sup>
17	SS316B6A				7745	kg/m <sup>3</sup>
18	Al 6061				2713	kg/m <sup>3</sup>
19	Hematite (Fe <sub>2</sub> O <sub>3</sub> )				5240	kg/m <sup>3</sup>
20	Goethite (FeOOH)				4264	kg/m <sup>3</sup>
21	Diaspore (AlOOH)				3400	kg/m <sup>3</sup>
22	Weight Fraction B in SS316B6A				0.016	
23	Weight Fraction Iron in A516				0.98535	
24	Weight Fraction Iron in SS316B6A				0.60445	
25	Weight Fraction Al in 6061				0.9668	
26	Molecular Weight of Diaspore (AlOOH)				59.98816409	g/mole
27	Atomic Weight of Oxygen (nat.)				15.9994	g/mole
28	Molecular Weight of Hematite (Fe <sub>2</sub> O <sub>3</sub> )				159.6922	g/mole
29	Molecular Weight of Goethite (FeOOH)				88.8447	g/mole
30						
31						
32						

VolMass

	A	B	C	D	E	F
33						Mass
34	Carbon Steel Components		Volume (m <sup>3</sup> )		Mass (kg)	Fe (kg)
35	Single Carbon Steel Tube		0.01438		112.5894251	110.940
36	<b>Total Carbon Steel</b>		0.91129		7137.222347	7032.662
37	Extra CS added for criticality control ----->				0	0.000
38	<b>Total Borated SS</b>		0.27199		2106.594799	1273.331
39						
40						Mass
41					Mass (kg)	Al (kg)
42	<b>Al Plates</b>		0.09042		245.3143582	237.170
43	Total Basket Volume		1.274 m <sup>3</sup>		TOTALS	
44						
45						
46		Intact			Degraded	Degraded
47		Thickness	Fe <sub>2</sub> O <sub>3</sub>	FeOOH	Thickness (mm)	Thickness (mm)
48		between adj	Volume	Volume	between adj.	between adj.
49		assemblies	Expansion	Expansion	assys (Fe <sub>2</sub> O <sub>3</sub> )	assys (FeOOH)
50	CS tube	10	2.11	2.88	21.06	28.79
51	B-SS plate	5	1.28	1.75	6.39	8.73
52					27.44	37.53
53	% of Void Space outside of assemblies occupied by corrosion products					
54	at theoretical density					
55	Fe goes to Fe <sub>2</sub> O <sub>3</sub>	53.86%				
56	Fe goes to FeOOH	72.39%				
57						
58	% of Basket Outside of Fuel Region			19.54%		
59	Volume Outside of Fuel Region			1.483 m <sup>3</sup>		
60	Volume Around Fuel Region (Fe <sub>2</sub> O <sub>3</sub> )			1.536 m <sup>3</sup>		
61	Volume In Fuel Region (Fe <sub>2</sub> O <sub>3</sub> )			1.476 m <sup>3</sup>		
62	Volume Around Fuel Region (FeOOH)			1.039 m <sup>3</sup>		
63	Volume In Fuel Region (FeOOH)			1.972 m <sup>3</sup>		
64						
65	Vol% Corrosion Products Around and Outside of Fuel Region (Fe <sub>2</sub> O <sub>3</sub> )				31.31%	
66	Vol% Corrosion Products Around and Outside of Fuel Region (FeOOH)				50.80%	

## VolMass

	A	B	C	D	E	F
67			Isotope List			
68						
69		Element	Symbol	Isotope	MCNP ID	Atomic Weight
70	1	Hydrogen	H	H-1	1001.50C	1.00782519
71			D	H-2	1002.55C	2.01410222
72			T	H-3	1003.50C	3.01604971
73	2	Helium	He	nat.	2000.01C	4.0026
74			He	He-4	2004.50C	4.00260312
75	3	Lithium	Li	Li-6	3006.50C	6.0151247
76			Li	Li-7	3007.55C	7.0160039
77	4	Beryllium	Be	Be-9	4009.50C	9.0121855
78	5	Boron	B	B-10	5010.50C	10.0129388
79			B	B-11	5011.56C	11.0093053
80	6	Carbon	C	nat.	6000.50C	12.01115
81			C	C-12	6012.50C	12
82	7	Nitrogen	N	N-14	7014.50C	14.00307439
83	8	Oxygen	O	O-16	8016.50C	15.994915
84	9	Fluorine	F	F-19	9019.50C	18.9984046
85	11	Sodium	Na	Na-23	11023.50C	22.9897707
86	12	Magnesium	Mg	nat.	12000.50C	24.312
87	13	Aluminum	Al	Al-27	13027.50C	26.9815389
88	14	Silicon	Si	nat.	14000.50C	28.086
89	15	Phosphorus	P	P-31	15031.50C	30.9737647
90	16	Sulfur	S	S-32	16032.50C	31.9720737
91	17	Chlorine	Cl	nat.	17000.50C	35.452
92	19	Potassium	K	nat.	19000.50C	39.102
93	20	Calcium	Ca	nat.	20000.50C	40.08
94	22	Titanium	Ti	nat.	22000.50C	47.9
95	23	Vanadium	V	nat.	23000.50C	50.942
96	24	Chromium	Cr	nat.	24000.50C	51.996
97	25	Manganese	Mn	Mn-55	25055.50C	54.9380503
98	26	Iron	Fe	nat.	26000.55C	55.847
99	27	Cobalt	Co	Co-59	27059.50C	58.933189
100	28	Nickel	Ni	nat.	28000.50C	58.71
101	29	Copper	Cu	nat.	29000.50C	63.54



## VolMass

	A	B	C	D	E	F
102			Isotope List			
103						
104		Element	Symbol	Isotope	MCNP ID	Atomic Weight
105	30	Zinc	Zn	nat.		65.37
106	33	Arsenic	As	As-75	33075.35C	74.9215964
107	38	Strontium	Sr	nat.		87.62
108	40	Zirconium	Zr	nat.	40000.50C	91.22
109	41	Niobium	Nb	Nb-93	41093.50C	92.906382
110	42	Molybdenum	Mo	nat.	42000.50C	95.94
111			Mo	Mo-95	42095.50C	94.905839
112	43	Technetium	Tc	Tc-99*	43099.50C	98.90627501
113	44	Ruthenium	Ru	Ru-101	44101.50C	100.905576
114	45	Rhodium	Rh	Rh-103	45103.50C	102.905511
115	47	Silver	Ag	Ag-109	47109.50C	108.904756
116	48	Cadmium	Cd	nat.	48000.50C	112.4
117	49	Indium	In	nat.		114.82
118	50	Tin	Sn	nat.	50000.35C	118.69
119	55	Cesium	Cs	Cs-133	55133.50C	132.905355
120			Cs	Cs-135		134.90577
121	56	Barium	Ba	nat.	56138.50C	137.34
122	57	Lanthanum	La	nat.		138.91
123	58	Cerium	Ce	nat.		140.12
124	60	Neodymium	Nd	Nd-143	60143.50C	142.909779
125			Nd	Nd-145	60145.50C	144.912538
126	62	Samarium	Sm	Sm-147	62147.50C	146.914867
127			Sm	Sm-149	62149.50C	148.91718
128			Sm	Sm-150	62150.50C	149.917276
129			Sm	Sm-151	62151.50C	150.919919
130			Sm	Sm-152	62152.50C	151.919756
131	63	Europium	Eu	Eu-151	63151.55C	150.919838
132			Eu	Eu-153	63153.55C	152.921242
133			Eu	Eu-154	63154.50C	153.923053
134	64	Gadolinium	Gd	nat.	64000.35C	157.25
135			Gd	Gd-155	64155.50C	154.922664
136			Gd	Gd-157	64157.50C	156.924025
137	72	Hafnium	Hf	nat.	72000.50C	178.49

## VolMass

	A	B	C	D	E	F
138			Isotope List (Continued)			
139						
140		Element	Symbol	Isotope	MCNP ID	Atomic Weight
141	73	Tantalum	Ta	Ta-181	73181.50C	180.948007
142	74	Tungsten	W	nat.	74000.55C	183.85
143	82	Lead	Pb	nat.	82000.50C	207.19
144	92	Uranium	U	U-233	92233.50C	233.039522
145			U	U-234	92234.50C	234.040904
146			U	U-235	92235.50C	235.043915
147			U	U-236	92236.50C	236.045637
148			U	U-238	92238.50C	238.05077
149	93	Neptunium	Np	Np-237	93237.55C	237.048056
150	94	Plutonium	Pu	Pu-238	94238.50C	238.049511
151			Pu	Pu-239	94239.55C	239.052146
152			Pu	Pu-240	94240.50C	240.053882
153			Pu	Pu-241	94241.50C	241.056737
154			Pu	Pu-242	94242.50C	242.058725
155			Pu	Pu-243	94243.35C	243.061972
156	95	Americium	Am	Am-241	95241.50C	241.056714
157			Am	Am-242m	95242.50C	242.059502
158			Am	Am-243	95243.50C	243.061367
159	96	Curium	Cm	Cm-243	96243.35C	243.06137
160			Cm	Cm-245	96245.35C	245.065371
161			Cm	Cm-248	96248.35C	248.0722

	G	H	I	J	K	L
1						
2						
3						
4						
5						
6						
7	Assembly Width		13.8125	cm		
8	Assembly Length		368.91	cm		
9						
10						
11						
12						
13						
14						
15	Reference					
16	BBA00000-01717-0200-00002 REV00					
17	BBA00000-01717-0200-00002 REV00					
18	ASME Code Table NF-2					
19	CRC, 66th edition					
20	Encyclopeia of Minerals					
21	Encyclopeia of Minerals					
22	BBA00000-01717-0200-00002 REV00					
23	BBA00000-01717-0200-00002 REV00					
24	BBA00000-01717-0200-00002 REV00					
25	ASTM B308/B308M-96					
26	=Al + 2*O + H					
27	Chart of Nuclides, 14th Edition					
28	=2*Fe + 3*O					
29	=Fe + 2*O + H					
30						
31						
32						

VolMass

	G	H	I	J	K	L
33		moles	Mass	Volume	Mass	Volume
34	moles Fe	Fe2O3	Fe2O3 (kg)	Fe2O3 (m^3)	FeOOH (kg)	FeOOH (m^3)
35	1.986E+03	9.932E+02	158.614	0.030	176.490	0.041
36	1.259E+05	6.296E+04	10054.804	1.919	11187.968	2.624
37	0.000E+00	0.000E+00	0.000	0.000	0.000	0.000
38	2.280E+04	1.140E+04	1820.519	0.347	2025.689	0.475
39						
40			Mass	Volume		
41	moles Al		AlOOH (kg)	AlOOH (m^3)		
42	8.790E+03		527.301	0.155		
43				2.421		
44						
45						
46						
47						
48		Maximum Boron adsorption on corrosion products				
49			mmol B/kg	mol B/WP	g B/WP	
50		Al oxide	6.5	3.42745547	37.0507936	
51		Fe2O3	2	23.75064619	256.744485	
52		FeOOH	37	488.9053124	5285.06643	
53		(from Goldberg & Glaubig, Boron Adsorption on Aluminum and Iron Oxide Minerals)				
54						
55		Maximum % of original B adsorbed on corrosion products				
56		AlOOH + Fe2O3		0.87%		
57		AlOOH + FeOOH		15.79%		
58						
59						
60						
61						
62						
63						
64						
65						
66						

VolMass

	G	H	I	J	K	L
67						
68		Water (from BBA000000-01717-0200-00002 REV00 p.I-19)				
69		Num Dens. for 1 g/cc	Atoms/b-cm			
70		H	6.69E-02			
71		O	3.34E-02			
72		H2O	1.00E-01			
73						
74		Avogadro's Number (Na)	0.602252			
75						
76		Number Density for Uniform Fe2O3/AIOOH/Water Mixture				
77			MCNP ID	atoms/barn-cm		
78		Fe	26000.55C	1.992570E-02		
79		Al	13027.50C	1.177646E-03		
80		O	8016.50C	4.767099E-02		
81		H	1001.50C	3.203195E-02		
82		TOTAL		1.008063E-01		
83						
84		Number Density for Uniform FeOOH/AIOOH/Water Mixture				
85			MCNP ID	atoms/barn-cm		
86		Fe	26000.55C	1.992570E-02		
87		Al	13027.50C	1.177646E-03		
88		O	8016.50C	5.144034E-02		
89		H	1001.50C	3.957066E-02		
90		TOTAL		1.121143E-01		
91						
92						
93		Boron Numberdensity for adsorbtion on Uniform FeOOH/AIOOH/Water Mixture				
94		B10	5010.50C	1.312604E-05		
95		New TOTAL		1.121275E-01		
96						
97						
98						
99						
100						
101						

VolMass

	G	H	I	J	K	L
102						
103						
104						
105						
106						
107						
108						
109						
110						
111						
112						
113						
114						
115						
116						
117						
118						
119						
120						
121						
122						
123						
124						
125						
126						
127						
128						
129						
130						
131						
132						
133						
134						
135						
136						
137						

VolMass

	G	H	I	J	K	L
138						
139						
140						
141						
142						
143						
144						
145						
146						
147						
148						
149						
150						
151						
152						
153						
154						
155						
156						
157						
158						
159						
160						
161						

Results

	A	B	C	D	E	F	G
1	Enrichment	Burnup (Gwd)	Time (Years)	keff	2r	ENCF (MeV)	
2	3.50%	20	12,000	1.0053	0.0025	0.1649	
3	3.50%	20	14,000	1.0101	0.0025	0.1650	
4	3.50%	20	18,000	1.0082	0.0026	0.1644	
5	3.50%	20	25,000	1.0069	0.0028	0.1620	
6	3.50%	20	35,000	1.0028	0.0024	0.1603	
7	3.50%	25	12,000	0.9553	0.0027	0.1770	
8	3.50%	25	18,000	0.9585	0.0026	0.1730	
9	3.50%	25	25,000	0.9556	0.0034	0.1723	
10	3.50%	25	35,000	0.9519	0.0028	0.1698	
11	3.50%	30	12,000	0.9167	0.0026	0.1842	
12	3.50%	30	14,000	0.9120	0.0032	0.1845	
13	3.50%	30	18,000	0.9134	0.0028	0.1802	
14	3.50%	30	25,000	0.9141	0.0028	0.1797	
15	3.50%	30	35,000	0.9074	0.0029	0.1793	
16	4.00%	20	12,000	1.0494	0.0026	0.1592	
17	4.00%	20	14,000	1.0509	0.0028	0.1595	
18	4.00%	20	18,000	1.0461	0.0025	0.1573	
19	4.00%	20	25,000	1.0503	0.0026	0.1551	
20	4.00%	20	35,000	1.0439	0.0027	0.1554	
21	4.00%	25	12,000	1.0028	0.0026	0.1654	
22	4.00%	25	14,000	1.0015	0.0034	0.1667	
23	4.00%	25	18,000	1.0049	0.0028	0.1653	
24	4.00%	25	25,000	1.0033	0.0034	0.1639	
25	4.00%	25	35,000	1.0018	0.0026	0.1633	
26	4.00%	30	12,000	0.9606	0.0028	0.1738	
27	4.00%	30	14,000	0.9674	0.0025	0.1739	
28	4.00%	30	18,000	0.9622	0.0024	0.1709	
29	4.00%	30	25,000	0.9633	0.0028	0.1710	
30	4.00%	30	35,000	0.9610	0.0028	0.1691	
31	4.00%	35	12,000	0.9256	0.0028	0.1815	
32	4.00%	35	14,000	0.9284	0.0024	0.1807	
33	4.00%	35	18,000	0.9294	0.0023	0.1775	
34	4.00%	35	25,000	0.9246	0.0027	0.1773	
35	4.00%	35	35,000	0.9214	0.0029	0.1760	
36	4.00%	40	12,000	0.8883	0.0026	0.1885	
37	4.00%	40	14,000	0.8861	0.0027	0.1885	
38	4.00%	40	18,000	0.8887	0.0024	0.1866	
39	4.00%	40	25,000	0.8869	0.0027	0.1843	
40	4.00%	40	35,000	0.8815	0.0027	0.1832	



Results

	A	B	C	D	E	F	G
41	4.50%	25	18,000	1.0431	0.0026	0.1589	
42	4.50%	25	25,000	1.0440	0.0028	0.1576	
43	4.50%	25	35,000	1.0397	0.0025	0.1573	
44	4.50%	30	10,000	1.0028	0.0028	0.1663	
45	4.50%	30	12,000	1.0049	0.0029	0.1676	
46	4.50%	30	14,000	1.0053	0.0029	0.1668	
47	4.50%	30	18,000	1.0058	0.0028	0.1654	
48	4.50%	30	25,000	1.0076	0.0029	0.1639	
49	4.50%	30	35,000	1.0057	0.0029	0.1621	
50	4.50%	35	1,000	0.9518	0.0030	0.1806	
51	4.50%	35	2,000	0.9592	0.0027	0.1794	
52	4.50%	35	4,000	0.9630	0.0026	0.1788	
53	4.50%	35	8,000	0.9652	0.0030	0.1747	
54	4.50%	35	10,000	0.9677	0.0032	0.1744	
55	4.50%	35	12,000	0.9696	0.0028	0.1727	
56	4.50%	35	14,000	0.9667	0.0031	0.1730	
57	4.50%	35	18,000	0.9693	0.0031	0.1702	
58	4.50%	35	25,000	0.9709	0.0031	0.1708	
59	4.50%	35	35,000	0.9689	0.0029	0.1675	
60	4.50%	35	45,000	0.9621	0.0025	0.1670	
61	4.50%	35	100,000	0.9506	0.0025	0.1646	
62	4.50%	35	250,000	0.9502	0.0029	0.1633	
63	4.50%	40	18,000	0.9369	0.0023	0.1763	
64	4.50%	40	25,000	0.9331	0.0030	0.1768	
65	4.50%	40	35,000	0.9330	0.0028	0.1723	
66	4.50%	45	18,000	0.8998	0.0023	0.1841	
67	4.50%	45	25,000	0.8991	0.0025	0.1820	
68	4.50%	45	35,000	0.8940	0.0024	0.1813	

Results

	H	I	J	K	L	M	N	O
1								
2		file	keff	2σ	AENCF	Δk/keffbase		
3	base case	35b45nf.O	0.9709	0.0031	0.1708	0.0000		
4	2.7 cm	CASE2F.O	0.8858	0.0029	0.1692	-0.0876		
5	2.7 cm FeOOH	CASE3F.O	0.8691	0.0027	0.1688	-0.1049		
6	3.7 cm FeOOH	CASE4F.O	0.8327	0.0026	0.1705	-0.1424		
7	3.7 cm FeOOH + 1	CASE5F.O	0.7660	0.0022	0.1871	-0.2111		
8								
9								
10		CASE2				CASE3		
11	Δk/keff=	-0.087638				-0.104899		
12								
13								
14	e	b	keff		e	b	keff	
15	5	34.64647	0.93		5	32.11001	0.93	
16	4.5	28.95306	0.93		4.5	26.41659	0.93	
17	4	23.25964	0.93		4	20.72318	0.93	
18	3.5	17.56608	0.930001		3.5	15.02976	0.93	
19	3	11.87266	0.930001		3	9.336481	0.929999	
20	2.5	6.179378	0.93		2.5	3.642917	0.93	
21	2	0.485817	0.930001		2.180077	0	0.93	
22	1.957322779	0	0.93					
23								
24		CASE4				CASE4		
25	Δk/keff=	-0.142389			Δk/keff=	-0.211107		
26	e	b	keff		e	b	keff	
27	5	26.24954	0.93		5	14.0613	0.93	
28	4.5	20.55612	0.93		4.5	8.367882	0.93	
29	4	14.8627	0.93		4	2.674463	0.93	
30	3.5	9.169283	0.93		3.765127	0	0.93	
31	3	3.475864	0.93					
32	2.694747257	0	0.93					
33								
34								
35								
36								
37								
38								
39								
40								

Results

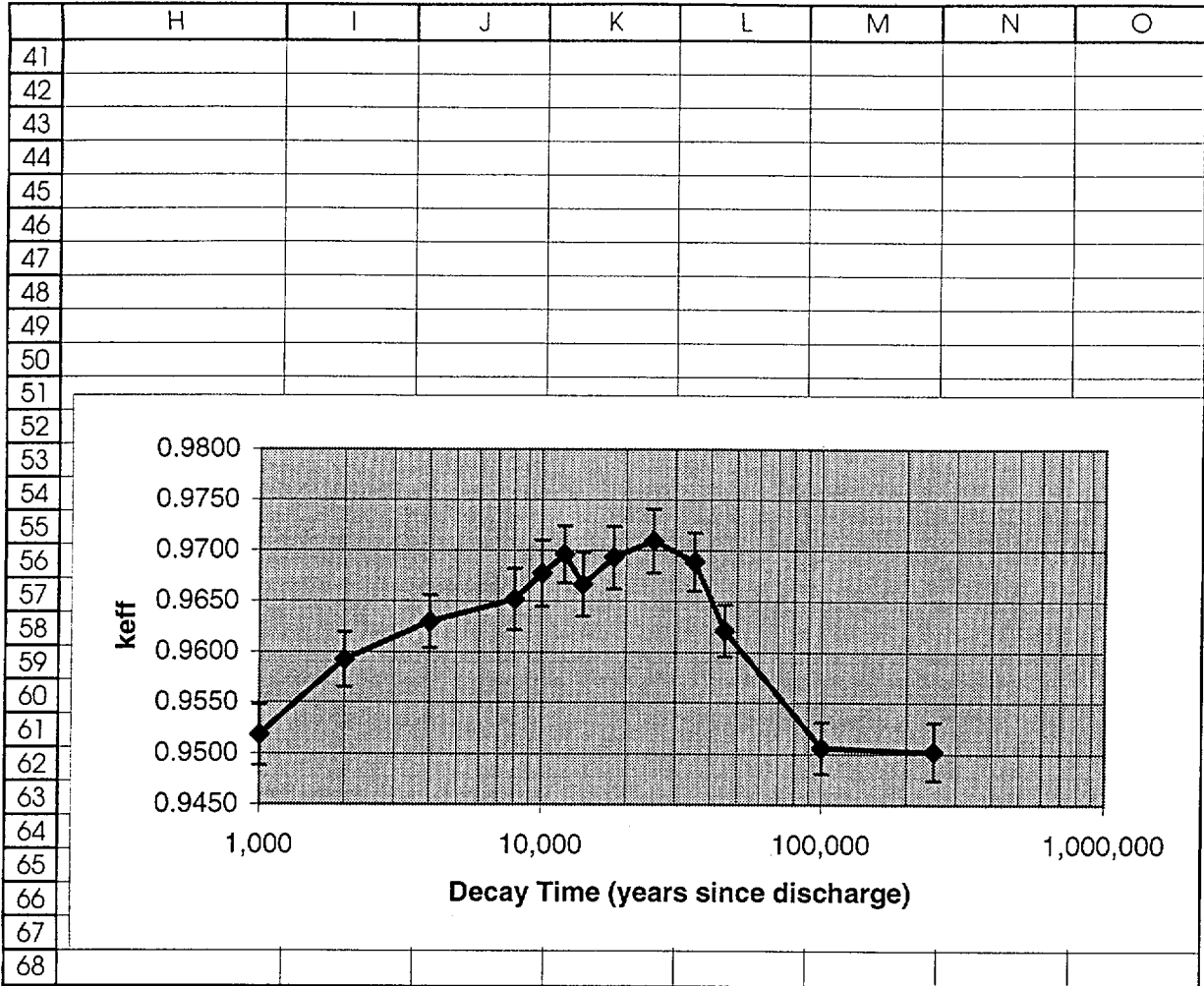

Regression

	A	B	C	D	E	F
1	Enrichment	Burnup (Gwd)	Time (Years)	Peak keff	2σ	
2	3.5	20	14,000	1.0101	0.0025	
3	3.5	25	18,000	0.9585	0.0026	
4	3.5	30	12,000	0.9167	0.0028	
5	4	20	14,000	1.0509	0.0028	
6	4	25	18,000	1.0049	0.0028	
7	4	30	14,000	0.9674	0.0025	
8	4	35	18,000	0.9294	0.0023	
9	4	40	18,000	0.8887	0.0024	
10	4.5	25	25,000	1.0440	0.0028	
11	4.5	30	25,000	1.0076	0.0029	
12	4.5	35	25,000	0.9709	0.0031	
13	4.5	40	18,000	0.9369	0.0023	
14	4.5	45	18,000	0.8998	0.0023	
15						
16						
17						
18	e	b	k			
19	5	46.16779263	0.929364			
20	4.5	40.47503519	0.929841			
21	4	34.78227774	0.930318			
22	3.5	29.08952029	0.930795			
23	3	23.39676284	0.931272			
24	2.5	17.7040054	0.931749			
25	2	12.01111893	0.932227			
26	1.5	6.3184905	0.932703			
27	1	0.625733052	0.93318			
28	0.945041304	0	0.93323243			
29						
30						
31	e	b	k			
32	5	39.71693643	0.979364			
33	4.5	34.02417898	0.979841			
34	4	28.33142153	0.980318			
35	3.5	22.63866409	0.980795			
36	3	16.94590664	0.981272			
37	2.5	11.25314919	0.981749			
38	2	5.560391743	0.982226			
39	1.511625799	0	0.98269191			
40						
41						
42						

Regression

	G	H	I	J	K	L	M
1							
2	SUMMARY OUTPUT						
3							
4	<i>Regression Statistics</i>						
5	Multiple R	0.996012017					
6	R Square	0.992039938					
7	Adjusted R Square	0.990447926					
8	Standard Error	0.005163383					
9	Observations	13					
10							
11	ANOVA						
12		<i>df</i>	<i>SS</i>	<i>MS</i>	<i>F</i>	<i>Significance F</i>	
13	Regression	2	0.033226253	0.016613	623.1358	3.19582E-11	
14	Residual	10	0.000266605	2.67E-05			
15	Total	12	0.033492858				
16							
17		<i>Coefficients</i>	<i>Standard Error</i>	<i>t Stat</i>	<i>P-value</i>	<i>Lower 95%</i>	<i>Upper 95%</i>
18	Intercept	0.850735909	0.015405425	55.22314	9.19E-14	0.816410477	0.885061341
19	X Variable 1	0.087294091	0.004325603	20.18079	1.97E-09	0.077656046	0.096932136
20	X Variable 2	-0.007750909	0.000220167	-35.2046	8.11E-12	-0.008241473	-0.007260346
21							
22							
23							
24							
25							
26							
27							
28							
29							
30							
31							
32							
33							
34							
35							
36							
37							
38							
39							
40							
41							
42							

Waste Stream

	A	B	C	D	E	F	G	H
1	<b>Enrichment and Burnup Binning for all BWR assemblies based on case1 of throughput study</b>							
2	<b>All Assembly Data Is From Reference 7.2"</b>							
3	Enrichment bins are in increments of 0.1 and are reported here as the top of each bin							
4	(ex: enrichment bin 1.10 to under 1.20 is reported as 1.19)							
5	Burnup bins are in increments of 1.0 and are reported here as the bottom of each bin							
6	(ex: burnup bin 1.0 to under 2.0 is reported as 1.00)							
7								
8	<b># of Assemblies</b>	<b>Enrichment, %</b>	<b>burnup, GWd/MTU</b>					
9			<b>1-99</b>					
10	1	1.19	12					
11	1	1.49	21					
12	1	1.89	8					
13	1	1.89	20					
14	1	1.99	23					
15	1	1.99	38					
16	1	2.09	0					
17	1	2.09	6					
18	1	2.09	7					
19	1	2.29	1					
20	1	2.29	32					
21	1	2.39	13					
22	1	2.39	14					
23	1	2.69	5					
24	1	2.69	42					
25	1	2.79	5					
26	1	2.79	6					
27	1	2.79	15					
28	1	2.89	5					
29	1	2.89	7					
30	1	2.89	8					
31	1	2.89	18					
32	1	2.99	20					
33	1	2.99	21					
34	1	3.09	26					
35	1	3.19	14					
36	1	3.19	18					
37	1	3.29	24					
38	1	3.39	1					
39	1	3.39	10					
40	1	3.39	11					
41	1	3.39	15					
42	1	3.39	24					
43	1	3.39	29					
44	1	3.59	4					
45	1	3.69	4					
46	1	3.69	7					
47	2	1.19	2					
48	2	1.19	14					
49	2	1.89	24					
50	2	2.09	4					
51	2	2.09	11					
52	2	2.29	5					
53	2	2.39	6					
54	2	2.69	39					
55	2	2.69	40					
56	2	3.19	22					
57	2	3.29	15					
58	2	3.39	13					
59	2	3.39	21					
60	2	3.49	21					

Waste Stream

	A	B	C	D	E	F	G	H
61	2	3.59	13					
62	2	3.79	25					
63	2	3.79	30					
64	2	3.79	34					
65	2	3.89	28					
66	2	3.99	7					
67	2	3.99	18					
68	3	1.09	7					
69	3	1.89	19					
70	3	1.89	21					
71	3	1.99	31					
72	3	2.09	10					
73	3	2.39	10					
74	3	2.49	13					
75	3	2.79	14					
76	3	2.79	38					
77	3	2.99	14					
78	3	2.99	17					
79	3	3.39	12					
80	3	3.49	19					
81	3	3.69	21					
82	4	1.19	13					
83	4	1.79	9					
84	4	2.09	12					
85	4	2.49	32					
86	4	2.69	37					
87	4	2.69	43					
88	4	2.89	38					
89	4	2.99	56					
90	4	2.99	57					
91	4	2.99	58					
92	4	3.09	25					
93	4	3.19	17					
94	4	3.19	29					
95	4	3.19	46					
96	4	3.29	21					
97	4	3.29	28					
98	4	3.39	47					
99	4	3.59	10					
100	4	3.69	52					
101	5	1.89	22					
102	5	2.19	29					
103	5	2.29	6					
104	5	2.39	22					
105	5	2.49	0					
106	5	2.99	13					
107	5	3.09	22					
108	5	3.09	23					
109	5	3.19	25					
110	5	3.39	26					
111	5	3.69	1					
112	5	3.69	6					
113	5	3.99	12					
114	6	1.89	14					
115	6	2.49	1					
116	6	2.49	2					
117	6	2.49	3					
118	6	2.69	38					
119	6	2.79	18					
120	6	2.89	9					
121	6	3.49	29					

Waste Stream

	A	B	C	D	E	F	G	H
122	6	3.89	23					
123	6	3.89	25					
124	6	3.89	27					
125	6	3.99	16					
126	6	3.99	19					
127	7	2.19	2					
128	7	2.29	28					
129	7	2.49	11					
130	7	2.59	30					
131	7	2.89	16					
132	7	3.39	27					
133	7	3.69	8					
134	8	1.79	21					
135	8	2.29	31					
136	8	2.69	10					
137	8	2.69	16					
138	8	2.89	19					
139	8	2.89	42					
140	8	2.99	55					
141	8	3.49	20					
142	8	3.59	18					
143	8	3.59	29					
144	8	3.99	17					
145	9	2.69	8					
146	9	2.69	17					
147	9	2.89	37					
148	9	2.99	11					
149	9	3.59	14					
150	10	1.19	5					
151	10	2.39	11					
152	10	2.69	34					
153	10	3.59	21					
154	10	3.69	19					
155	10	3.79	27					
156	10	3.99	13					
157	11	2.49	51					
158	11	2.79	19					
159	11	2.89	10					
160	11	2.89	35					
161	11	2.99	46					
162	11	3.29	48					
163	12	1.19	29					
164	12	1.89	2					
165	12	2.29	7					
166	12	2.49	16					
167	12	3.59	35					
168	12	3.69	9					
169	12	3.79	23					
170	13	1.89	18					
171	13	2.59	11					
172	13	2.89	14					
173	13	3.19	23					
174	13	3.59	19					
175	13	3.59	20					
176	13	3.69	10					
177	14	2.49	15					
178	14	2.79	17					
179	14	2.89	20					
180	14	3.19	26					
181	14	3.19	43					
182	15	2.59	12					



Waste Stream

	A	B	C	D	E	F	G	H
183	16	1.19	27					
184	16	1.69	11					
185	16	2.39	15					
186	16	2.59	9					
187	16	2.59	15					
188	16	2.69	35					
189	16	2.79	46					
190	16	2.89	13					
191	16	3.39	41					
192	16	3.69	14					
193	16	3.89	34					
194	17	2.69	13					
195	17	2.69	14					
196	17	3.99	14					
197	17	3.99	15					
198	18	2.29	3					
199	18	3.49	46					
200	19	2.09	17					
201	19	2.59	29					
202	19	2.89	11					
203	19	2.89	17					
204	20	0.99	10					
205	20	2.49	5					
206	20	2.49	18					
207	20	2.59	37					
208	20	2.79	41					
209	20	3.49	28					
210	21	2.29	8					
211	21	2.39	17					
212	21	3.69	15					
213	22	2.39	25					
214	22	2.59	8					
215	22	2.99	45					
216	23	2.49	49					
217	23	2.59	13					
218	23	3.69	17					
219	24	2.09	13					
220	24	2.09	35					
221	24	2.19	7					
222	24	2.29	30					
223	24	2.39	28					
224	24	2.59	14					
225	24	2.59	16					
226	24	2.59	32					
227	24	3.79	5					
228	25	1.99	1					
229	25	2.09	8					
230	25	3.29	49					
231	26	1.19	20					
232	26	2.39	16					
233	26	2.59	17					
234	29	2.69	9					
235	29	2.69	12					
236	29	3.69	13					
237	30	2.49	20					
238	31	1.79	12					
239	31	1.79	22					
240	31	2.49	7					
241	31	2.89	15					
242	32	0.79	1					
243	32	1.09	11					

Waste Stream

	A	B	C	D	E	F	G	H
244	32	2.29	15					
245	32	3.49	9					
246	32	3.49	16					
247	33	1.79	20					
248	33	2.19	0					
249	34	3.49	30					
250	34	3.69	18					
251	35	2.29	10					
252	35	2.29	11					
253	35	3.59	54					
254	36	1.69	22					
255	36	2.69	33					
256	37	2.99	23					
257	38	2.19	5					
258	38	2.49	6					
259	38	2.89	36					
260	39	1.89	16					
261	40	1.09	8					
262	42	3.49	24					
263	43	2.09	20					
264	43	2.89	40					
265	44	2.99	22					
266	44	3.39	43					
267	44	3.69	45					
268	45	2.49	8					
269	45	2.69	18					
270	45	2.99	24					
271	46	2.09	21					
272	46	3.69	50					
273	47	1.89	15					
274	48	2.19	6					
275	48	2.59	38					
276	48	3.09	41					
277	49	2.29	4					
278	49	3.89	45					
279	49	3.89	46					
280	49	3.89	47					
281	49	3.89	48					
282	49	3.89	50					
283	49	3.89	52					
284	49	3.89	53					
285	49	3.89	54					
286	49	3.89	55					
287	49	3.89	56					
288	50	2.49	4					
289	50	2.79	20					
290	52	0.99	16					
291	52	3.79	10					
292	53	1.19	19					
293	53	2.39	19					
294	53	3.39	31					
295	53	3.49	53					
296	53	3.49	55					
297	53	3.49	57					
298	53	3.49	59					
299	53	3.69	12					
300	53	3.79	50					
301	54	1.19	11					
302	54	1.89	17					
303	54	2.19	8					
304	55	2.39	24					

Waste Stream

	A	B	C	D	E	F	G	H
305	56	1.69	23					
306	56	2.09	25					
307	56	2.69	20					
308	56	2.99	40					
309	56	4.29	21					
310	58	1.19	8					
311	58	2.09	15					
312	58	2.99	42					
313	59	2.29	9					
314	59	3.59	15					
315	60	2.49	30					
316	60	3.49	52					
317	61	2.19	30					
318	63	3.49	49					
319	65	2.79	37					
320	67	3.69	16					
321	68	2.79	36					
322	68	3.29	6					
323	68	4.29	27					
324	70	2.29	14					
325	70	2.59	10					
326	72	1.79	3					
327	73	2.29	19					
328	73	3.09	24					
329	73	3.19	27					
330	75	1.69	4					
331	75	2.59	31					
332	76	2.49	14					
333	76	2.59	40					
334	76	2.79	39					
335	76	3.19	31					
336	76	4.29	16					
337	79	2.39	23					
338	79	3.49	26					
339	80	1.59	12					
340	80	3.39	23					
341	81	3.59	52					
342	84	3.29	20					
343	84	3.69	53					
344	84	3.69	57					
345	84	3.69	59					
346	84	3.69	61					
347	85	3.19	30					
348	85	3.29	47					
349	86	2.09	16					
350	87	2.29	26					
351	88	2.29	29					
352	88	3.49	50					
353	88	3.69	55					
354	88	3.89	38					
355	89	3.09	28					
356	90	2.39	26					
357	90	3.69	43					
358	92	0.79	6					
359	92	1.59	10					
360	92	3.49	11					
361	92	3.49	23					
362	92	4.09	21					
363	94	2.29	25					
364	96	1.59	15					
365	96	3.49	31					

Waste Stream

	A	B	C	D	E	F	G	H
366	96	3.59	38					
367	97	2.99	41					
368	98	1.19	7					
369	98	2.19	9					
370	98	4.29	58					
371	98	4.29	60					
372	98	4.29	61					
373	99	1.09	9					
374	99	2.29	13					
375	99	3.19	33					
376			100-199					
377	102	4.09	48					
378	102	4.09	49					
379	102	4.09	53					
380	102	4.09	55					
381	102	4.09	57					
382	102	4.09	59					
383	102	4.09	61					
384	102	4.09	63					
385	103	2.29	17					
386	103	2.99	44					
387	103	3.89	43					
388	104	2.29	16					
389	104	2.89	21					
390	104	3.19	24					
391	104	3.29	13					
392	104	3.69	47					
393	105	2.19	10					
394	105	2.59	18					
395	105	3.69	48					
396	106	2.49	10					
397	106	3.29	29					
398	108	3.49	47					
399	109	3.59	9					
400	109	4.09	46					
401	110	1.79	35					
402	110	3.39	39					
403	110	3.69	49					
404	111	2.29	20					
405	112	2.49	12					
406	113	2.79	42					
407	114	2.59	21					
408	116	3.19	28					
409	116	3.59	37					
410	116	3.59	49					
411	116	3.59	50					
412	116	3.59	51					
413	116	3.59	53					
414	116	3.69	44					
415	116	4.09	45					
416	117	3.89	29					
417	118	2.39	18					
418	120	0.99	13					
419	120	1.69	17					
420	120	2.79	45					
421	121	2.29	27					
422	122	1.09	10					
423	123	2.49	21					
424	123	3.69	11					
425	124	3.39	30					
426	125	1.79	15					

Waste Stream

	A	B	C	D	E	F	G	H
427	125	2.29	18					
428	126	3.69	20					
429	127	3.89	57					
430	128	0.79	5					
431	131	0.99	7					
432	132	1.79	16					
433	134	2.29	12					
434	134	2.89	22					
435	134	4.09	51					
436	135	2.29	22					
437	135	4.29	43					
438	136	2.19	13					
439	136	3.09	40					
440	137	1.19	6					
441	139	2.19	3					
442	140	0.79	2					
443	140	3.19	42					
444	140	3.59	39					
445	141	3.29	10					
446	143	1.19	9					
447	144	2.49	28					
448	145	2.09	14					
449	146	2.69	19					
450	147	2.29	21					
451	148	4.29	17					
452	152	2.39	21					
453	152	3.19	45					
454	152	3.59	24					
455	153	2.89	12					
456	155	2.39	20					
457	155	4.29	44					
458	156	2.49	9					
459	156	3.39	14					
460	156	3.69	51					
461	158	3.39	20					
462	158	3.59	44					
463	160	1.69	18					
464	160	2.49	23					
465	164	3.29	3					
466	167	3.59	11					
467	168	1.29	17					
468	168	2.09	19					
469	168	3.09	27					
470	168	3.59	27					
471	168	4.29	38					
472	172	1.59	9					
473	172	3.29	14					
474	172	3.39	32					
475	175	1.79	19					
476	175	3.59	48					
477	176	2.59	20					
478	176	3.69	38					
479	177	2.89	24					
480	177	3.59	28					
481	183	3.59	46					
482	184	2.09	22					
483	184	3.59	23					
484	184	3.59	34					
485	185	2.19	1					
486	185	3.19	41					
487	186	2.49	31					

Waste Stream

	A	B	C	D	E	F	G	H
488	186	3.29	18					
489	187	2.69	22					
490	192	3.59	8					
491	192	3.59	33					
492	194	2.99	27					
493	196	3.59	17					
494	196	4.09	7					
495	196	4.09	37					
496	199	2.69	21					
497	199	3.39	40					
498			200-299					
499	200	2.19	27					
500	201	3.79	46					
501	201	3.79	48					
502	201	3.79	49					
503	201	3.89	44					
504	203	3.89	16					
505	204	2.79	23					
506	208	2.79	32					
507	212	1.79	17					
508	212	2.79	22					
509	213	2.19	4					
510	214	2.59	27					
511	215	2.89	23					
512	220	1.19	10					
513	220	3.29	30					
514	220	3.49	17					
515	221	0.99	8					
516	221	2.29	23					
517	221	3.09	36					
518	224	3.19	21					
519	224	3.69	42					
520	225	3.29	27					
521	228	3.39	42					
522	228	3.79	18					
523	228	3.99	37					
524	231	3.59	55					
525	232	3.29	46					
526	232	3.59	30					
527	233	1.79	18					
528	236	3.79	52					
529	237	3.09	31					
530	239	3.19	34					
531	240	4.29	33					
532	243	3.49	48					
533	244	2.79	33					
534	245	3.59	6					
535	246	3.79	40					
536	247	2.69	31					
537	248	3.79	32					
538	249	2.79	28					
539	254	3.79	47					
540	256	3.29	12					
541	256	3.39	7					
542	256	3.49	27					
543	256	3.49	33					
544	264	3.79	43					
545	267	2.69	24					
546	268	1.69	16					
547	268	4.29	32					
548	269	2.59	19					

Waste Stream

	A	B	C	D	E	F	G	H
549	271	3.29	44					
550	272	3.39	17					
551	276	2.19	28					
552	277	2.19	15					
553	279	3.59	16					
554	282	3.69	46					
555	282	3.89	49					
556	283	2.09	23					
557	283	3.19	40					
558	284	3.29	8					
559	290	3.19	32					
560	293	3.89	51					
561	296	2.99	26					
562	297	2.99	12					
563			300-399					
564	304	3.39	9					
565	306	2.19	11					
566	308	0.79	4					
567	308	3.99	21					
568	310	3.19	11					
569	310	4.29	54					
570	311	2.59	28					
571	316	2.99	25					
572	316	4.29	26					
573	317	3.59	43					
574	318	2.69	32					
575	320	4.29	49					
576	322	3.49	32					
577	323	3.49	12					
578	324	3.49	25					
579	325	2.09	18					
580	329	2.19	14					
581	332	3.49	34					
582	333	3.09	33					
583	334	3.09	38					
584	336	2.59	22					
585	345	3.59	45					
586	346	2.49	39					
587	346	3.09	29					
588	350	4.09	65					
589	360	2.59	26					
590	369	2.49	19					
591	372	2.89	34					
592	372	4.29	19					
593	376	2.49	24					
594	390	2.79	30					
595	392	2.99	35					
596	392	3.59	47					
597	393	2.49	27					
598	396	2.79	26					
599	396	3.99	43					
600	398	3.79	42					
601			400-499					
602	405	3.09	35					
603	407	2.79	35					
604	407	3.29	43					
605	408	2.49	29					
606	408	4.29	56					
607	411	2.79	25					
608	416	2.99	28					
609	419	3.79	45					

Waste Stream

	A	B	C	D	E	F	G	H
610	420	2.79	24					
611	428	2.79	12					
612	434	2.99	36					
613	434	3.39	28					
614	436	4.29	50					
615	442	2.49	22					
616	445	2.49	25					
617	449	2.69	23					
618	451	2.19	26					
619	453	4.29	57					
620	456	3.29	11					
621	457	3.29	45					
622	461	3.29	25					
623	465	2.19	12					
624	469	3.79	41					
625	480	3.49	35					
626	487	1.79	14					
627	489	1.79	13					
628	490	2.19	25					
629	496	3.89	41					
630			500-999					
631	501	3.09	34					
632	501	4.29	59					
633	511	2.19	23					
634	513	2.89	33					
635	531	3.49	22					
636	539	2.89	27					
637	541	2.89	26					
638	542	2.59	23					
639	550	3.79	44					
640	551	2.69	25					
641	552	3.99	48					
642	569	4.29	51					
643	572	2.79	29					
644	572	3.39	35					
645	573	2.19	16					
646	577	3.49	42					
647	579	2.99	29					
648	580	2.49	26					
649	582	2.69	27					
650	582	3.29	23					
651	592	3.19	39					
652	595	2.59	25					
653	595	2.79	31					
654	595	3.19	38					
655	602	2.19	24					
656	604	3.09	37					
657	608	3.29	17					
658	609	2.79	27					
659	609	2.89	25					
660	618	4.29	55					
661	619	2.89	32					
662	620	2.99	31					
663	621	3.29	31					
664	626	3.19	37					
665	630	2.29	24					
666	636	0.79	3					
667	643	4.29	53					
668	664	2.79	34					
669	676	2.19	21					
670	676	3.39	38					



Waste Stream

	A	B	C	D	E	F	G	H
671	676	3.99	42					
672	678	2.19	18					
673	696	3.09	39					
674	700	3.29	32					
675	701	2.69	30					
676	716	2.59	24					
677	742	2.89	31					
678	749	3.59	42					
679	751	3.19	35					
680	775	2.19	17					
681	779	3.29	26					
682	787	3.39	34					
683	797	3.29	42					
684	801	2.69	29					
685	826	2.69	26					
686	835	3.49	41					
687	856	3.49	43					
688	865	2.99	32					
689	889	2.99	34					
690	899	3.39	44					
691	984	3.49	40					
692	992	2.99	37					
693	994	2.89	29					
694			<b>1000-1499</b>					
695	1001	3.49	39					
696	1004	2.89	30					
697	1031	3.29	40					
698	1044	2.19	22					
699	1048	3.29	39					
700	1050	3.29	41					
701	1056	3.39	37					
702	1059	2.19	19					
703	1067	2.99	33					
704	1158	2.99	30					
705	1161	3.59	40					
706	1194	2.19	20					
707	1239	3.19	36					
708	1277	3.29	33					
709	1314	3.29	34					
710	1401	2.69	28					
711	1435	2.89	28					
712	1469	3.49	36					
713	1478	3.49	45					
714			<b>1500-1999</b>					
715	1513	3.39	36					
716	1577	3.59	41					
717	1698	3.79	39					
718	1712	3.49	44					
719	1905	3.49	38					
720			<b>2000+</b>					
721	2928	3.29	35					
722	3062	3.49	37					
723	3088	2.99	38					
724	3360	3.29	38					
725	3928	3.29	37					
726	4169	4.29	52					
727	6126	3.29	36					
728								
729	<b>Total Number of Assemblies</b>							
730	167756							
731								

Waste Stream

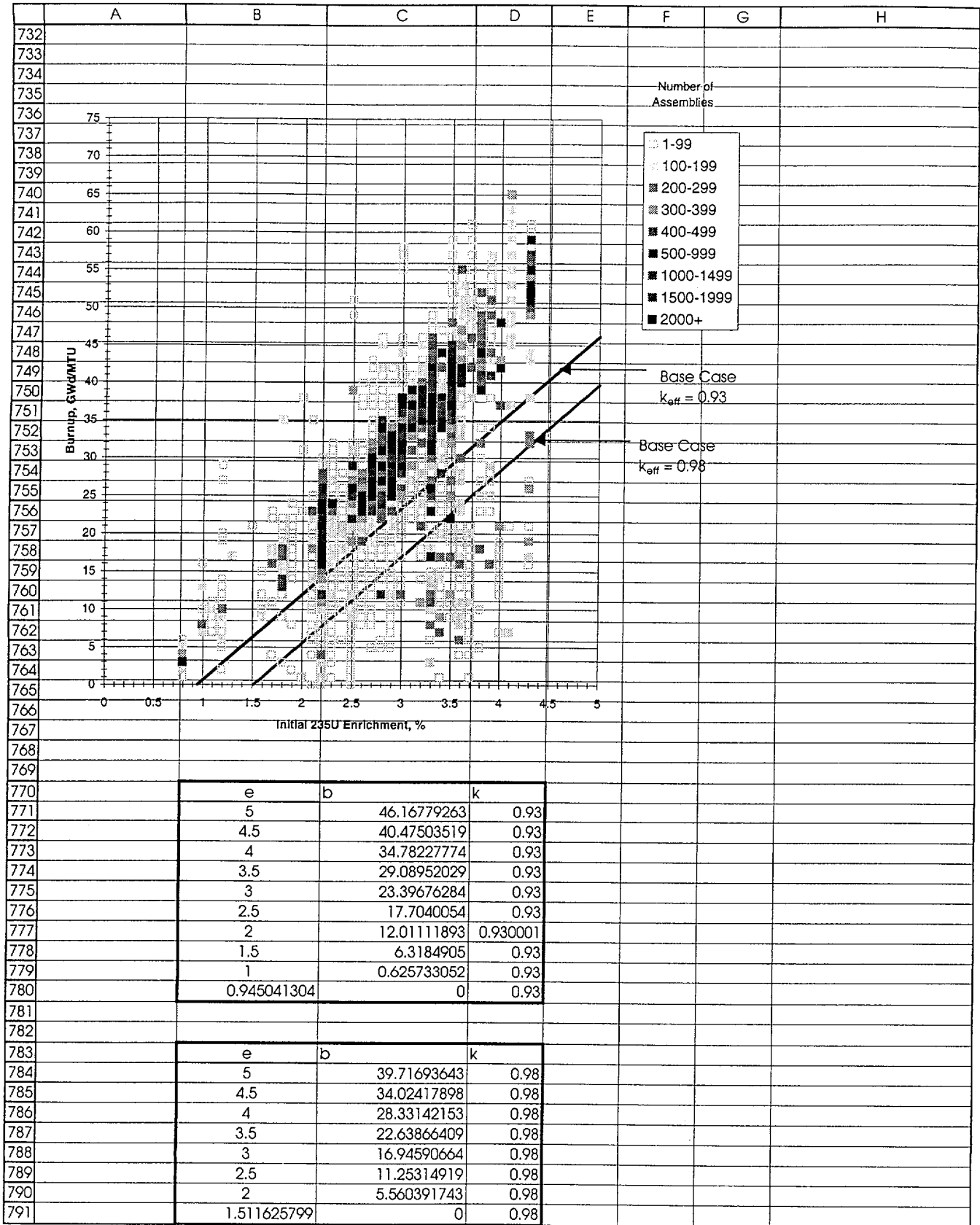

**ESTIMATE OF FRACTION OF BWR WASTE STREAM EXCEEDING VARIOUS  $K_{EFF}$  VALUES IN DIFFERENT DEGRADED CONFIGURATIONS**

Load in BWR waste stream data

A := READPRN("bwr.prn")

Define peak  $k_{eff}$  regression

$$C := \begin{bmatrix} 0.850736 \\ 0.087294 \\ -0.007751 \end{bmatrix} \quad k(e, b, adj) := (C_0 + C_1 \cdot e + C_2 \cdot b) \cdot (1 + adj)$$

Calculate peak postclosure  $k_{eff}$  for each batch of assemblies using regression

i := 0.. rows(A)

Base Case  $A_{i,6} := k\left(A_{i,1}, \frac{A_{i,2}}{1000}, 0\right)$       2.7 cm Separation  $A_{i,9} := k\left(A_{i,1}, \frac{A_{i,2}}{1000}, -0.0876\right)$

2.7 cm Separation with FeOOH  $A_{i,12} := k\left(A_{i,1}, \frac{A_{i,2}}{1000}, -0.1049\right)$       3.7 cm Separation with FeOOH  $A_{i,13} := k\left(A_{i,1}, \frac{A_{i,2}}{1000}, -0.1424\right)$

3.7 cm Separation with FeOOH and 15% Adsorbed  $^{10}B$   $A_{i,14} := k\left(A_{i,1}, \frac{A_{i,2}}{1000}, -0.2111\right)$

Calculate fraction of BWR waste stream which exceeds various peak postclosure  $k_{eff}$  values

		<u>0.93</u>	<u>0.98</u>
<u>Base Case</u>	$A_{i,7} := \text{if}(A_{i,6} \geq 0.93, A_{i,0}, 0)$ $A_{i,8} := \text{if}(A_{i,6} \geq 0.98, A_{i,0}, 0)$	$\frac{\sum A^{<7>}}{\sum A^{<0>}} = 0.112$	$\frac{\sum A^{<8>}}{\sum A^{<0>}} = 0.069$
<u>2.7 cm Separation</u>	$A_{i,10} := \text{if}(A_{i,9} \geq 0.93, A_{i,0}, 0)$ $A_{i,11} := \text{if}(A_{i,9} \geq 0.98, A_{i,0}, 0)$	$\frac{\sum A^{<10>}}{\sum A^{<0>}} = 0.042$	$\frac{\sum A^{<11>}}{\sum A^{<0>}} = 0.012$
<u>2.7 cm Separation with FeOOH</u>	$A_{i,15} := \text{if}(A_{i,12} \geq 0.93, A_{i,0}, 0)$ $A_{i,16} := \text{if}(A_{i,12} \geq 0.98, A_{i,0}, 0)$	$\frac{\sum A^{<15>}}{\sum A^{<0>}} = 0.029$	$\frac{\sum A^{<16>}}{\sum A^{<0>}} = 4.441 \cdot 10^{-3}$
<u>3.7 cm Separation with FeOOH</u>	$A_{i,17} := \text{if}(A_{i,13} \geq 0.93, A_{i,0}, 0)$ $A_{i,18} := \text{if}(A_{i,13} \geq 0.98, A_{i,0}, 0)$	$\frac{\sum A^{<17>}}{\sum A^{<0>}} = 9.079 \cdot 10^{-3}$	$\frac{\sum A^{<18>}}{\sum A^{<0>}} = 1.198 \cdot 10^{-3}$
<u>3.7 cm Separation with FeOOH and 15% Adsorbed <math>^{10}B</math></u>	$A_{i,19} := \text{if}(A_{i,14} \geq 0.93, A_{i,0}, 0)$ $A_{i,20} := \text{if}(A_{i,14} \geq 0.98, A_{i,0}, 0)$	$\frac{\sum A^{<19>}}{\sum A^{<0>}} = 0$	$\frac{\sum A^{<20>}}{\sum A^{<0>}} = 0$